

-REPERE CABLE BLINDE
 -SCREENED CABLE TAG
 -GESCHIRMT KABELMARKEN

FIL 0.5mm² COULEUR: m=marron , bl=blanc , v= vert , j=jaune
 0.5mm² WIRE COLOR: m=brown , bl=white , v=green , j=yellow
 0.5mm² LEITUNG FARBE: m=braun , bl=weiss , v=grün , j=gelb

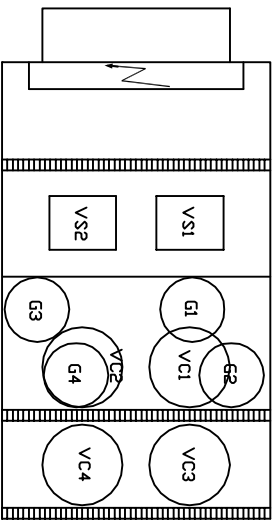

RT 34 PC

SCHEMA PUISSANCE

Dessiné: T/Y
 Date: 25.05.99

HCHLENNOX
 USINE DE L'ONGVIC

215978

LIAISON EXTENSION ACTIONNEURS
 OUTLET EXPANSION CONNECTION
 VERBINDUNG MIT EINER ERWEITERUNGSAUSGANGSKARTE

BRS2ANA

EXTENSION ACTIONNEURS
 EXPANSION CONNECTION
 ERWEITERUNGSAUSGANGSKARTE

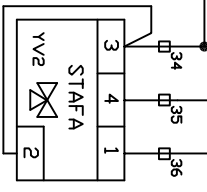
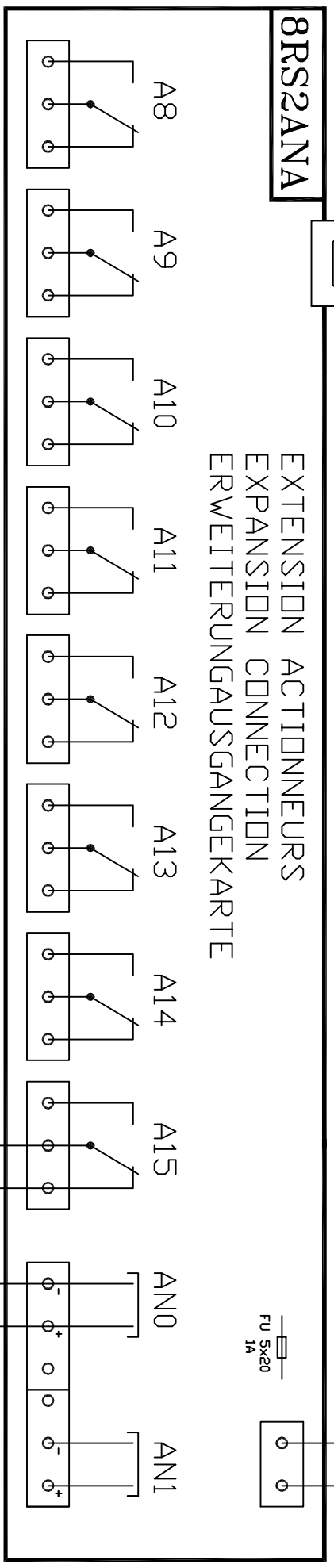

FOLIO 1

24V/0

NDTAluH circuit rc en // avec chaque bobine

Index	DATE	NOM	MODIFICATIONS	RT 34 PC	Designe: T/Y	215978
				SORTIES EXTENSION	Date: 25.05.99	5
						16



RT en froid BT15-16-17-18 placées sur la batterie interieure
 RT en pompe BT15-16-17-18 placées sur la batterie extérieure

ENTREES SONDES CLIMATIC
 CLIMATIC SENSORS INLET
 CLIMATIC SONDE EINGANG

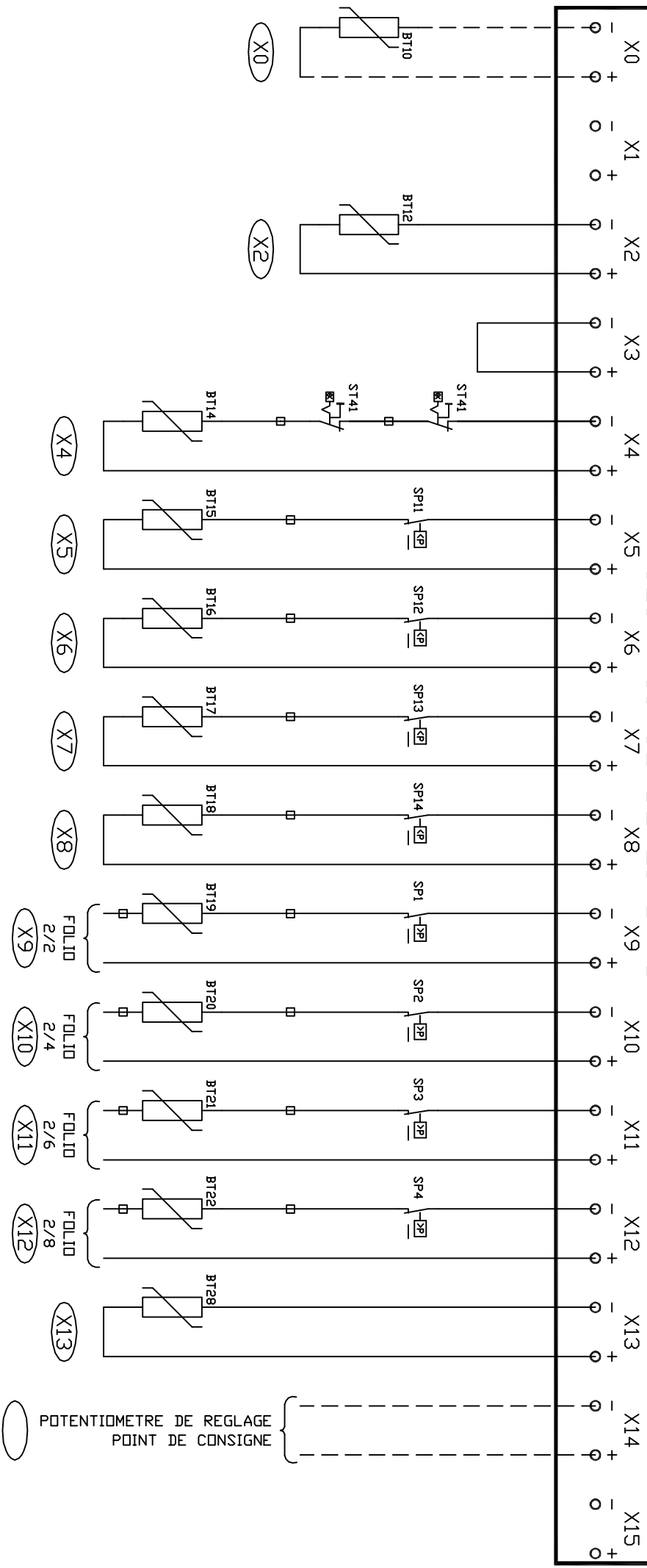

-REPERE CABLE BLINDE
 -SCREENED CABLE TAG
 -GESCHIRMT KABELMARKEN

FIL 0.5mm²
 0.5mm² WIRE
 0.5mm² LEITUNG

A	08.06.99	T/Y	BT14	INSTALLÉE / APPAREIL	RT 34 PC	Entreprises Climatic	Designe: T/Y	215978	6
Index	DATE	NOM	MODIFICATIONS		ENTREES CLIMATIC		Date: 25.05.99		16



USINE DE LONGVIC

LIAISON MODEM DU MICRO
 MODEM OR COMPUTER CONNECTION
 VERBINDUNG MIT MODEM ODER COMPUTER
 (FOLIO 3)

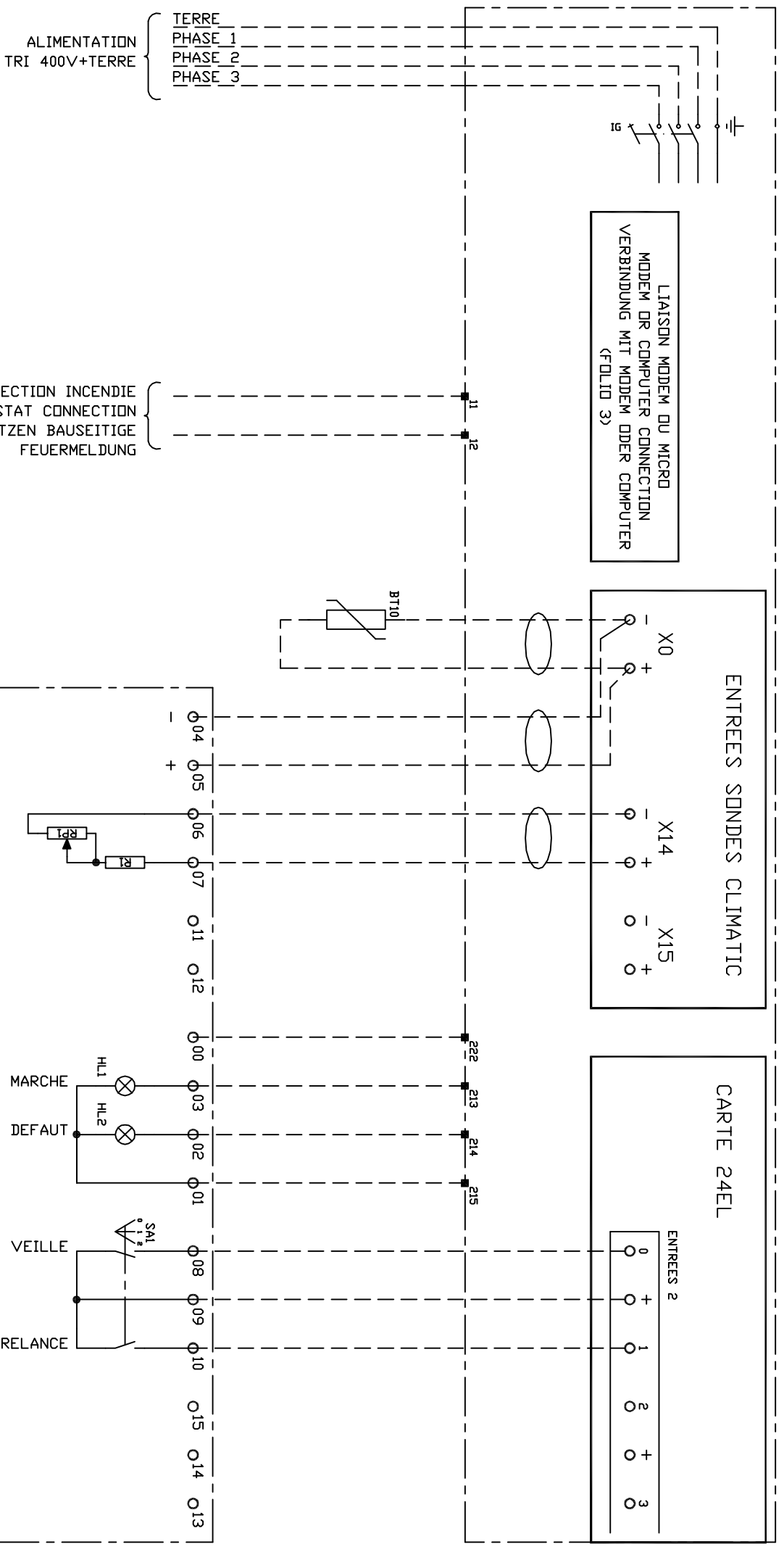
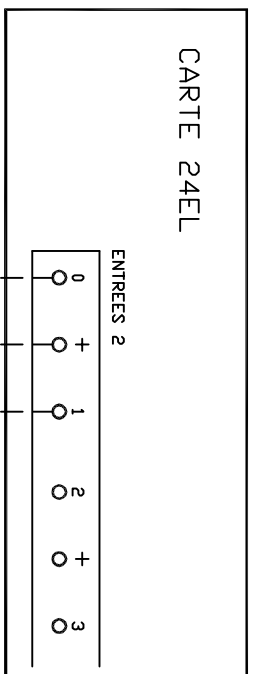
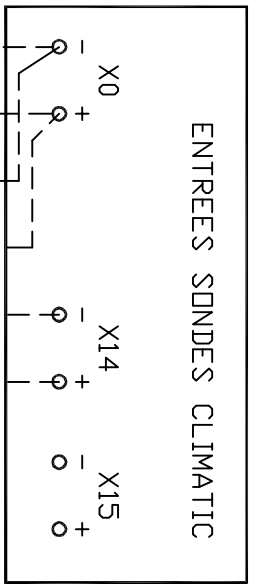

BOITIER COMMANDE A DISTANCE

-REPERE CABLE BLINDE
 -SCREENED CABLE TAG
 -GESCHIRMT KABELMARKEN

FIL 0.5mm2 COULEUR: m=marron , bl=blanc , v= vert , j=jaune
 0.5mm2 WIRE COLOR: m=brown , bl=white , v=green , j=yellow
 0.5mm2 LEITUNG FARBE: m=braun , bl=weiss , v=grün , j=gelb

A	08.06.99	T/Y	- BT14	RT 34 PC	Designe: T/Y	215978
Index	DATE	NOM	MODIFICATIONS	RACCORDEMENT CLIENT	Date: 25.05.99	9
						16



USINE DE LONGVIC

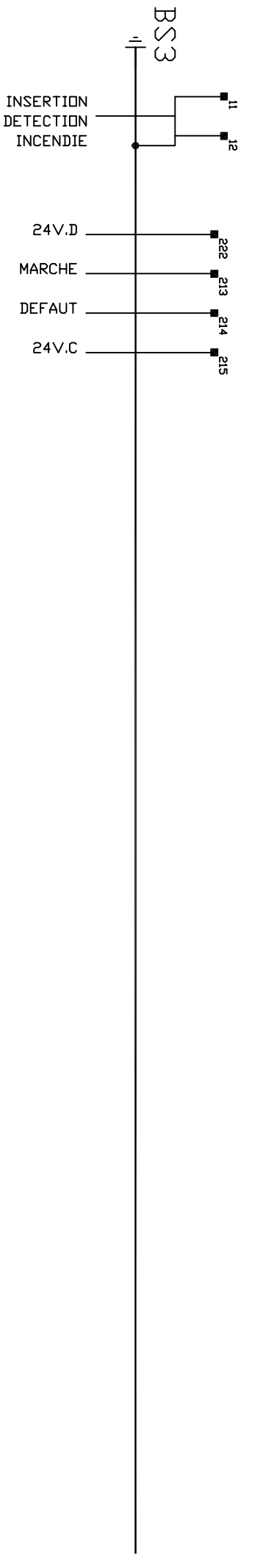
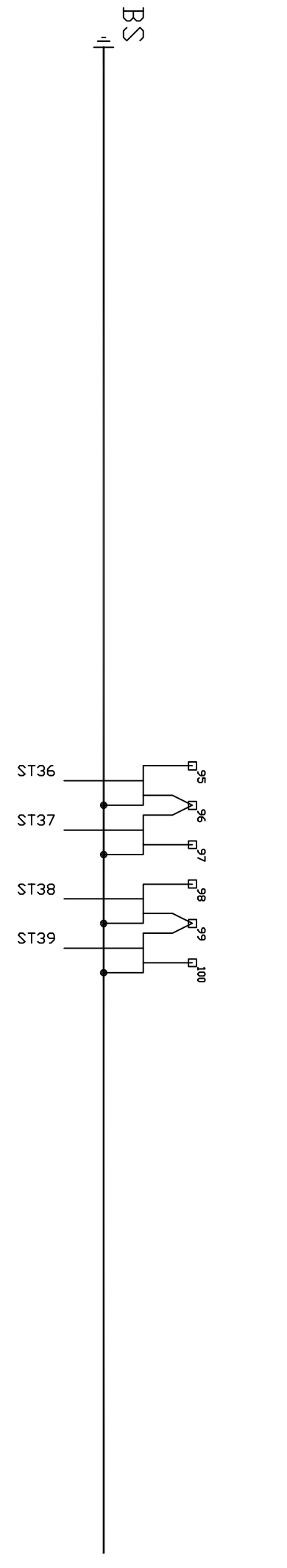
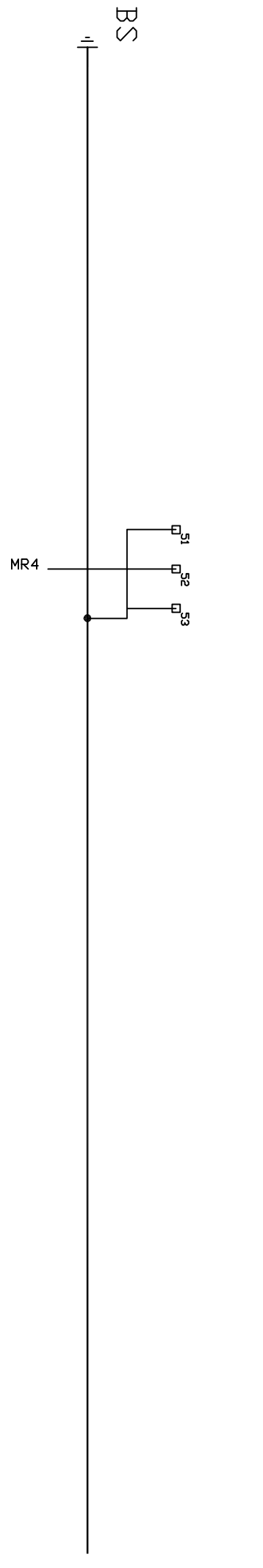
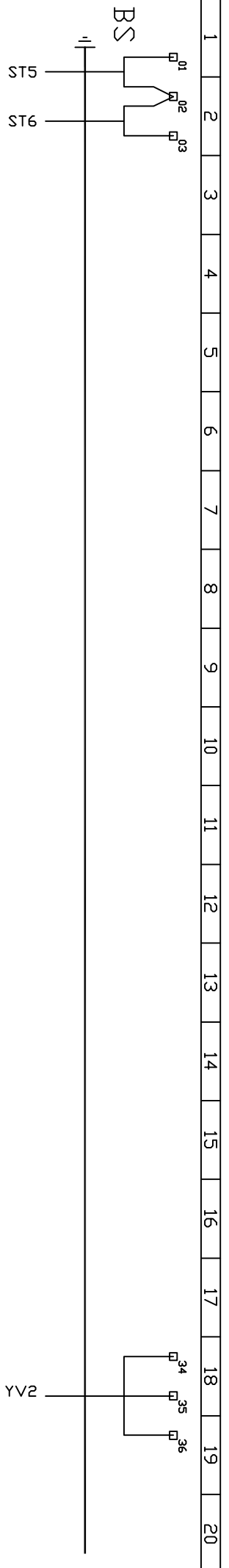

A	08.06.99	T/Y	- BORNES 22 23	RT 34 PC	Designe:
Index	DATE	NOM	MODIFICATIONS	BORNIER BS	Date:
					25.05.99
				HCH/LENNOX USINE DE LONGVIC	
				215978	
				11/16	

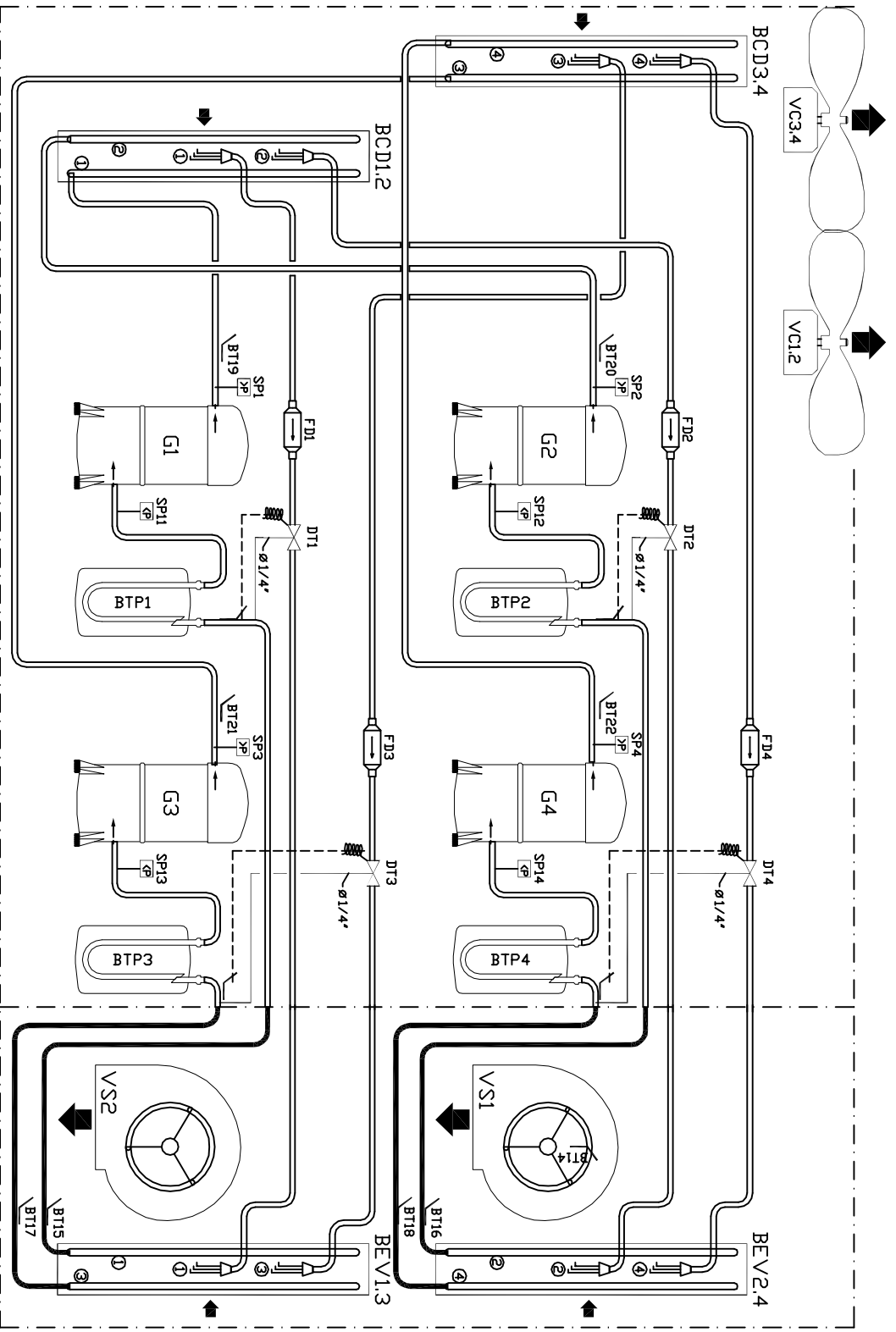

UNITE FRIGORIFIQUE
COOLING UNIT

UNITE DE TRAITEMENT
AIR HANDLING UNIT

DIAMETRE TUYAUTERIES PIPING DIAMETER	TUYAUTERIES DIAMETER
REFOULEMENT DISCHARGE	7/8"
ASPIRATION SUCTION	1 3/8"
LIGNE LIQUIDE LIQUID CIRCUIT	5/8"

— TUYAUTERIE CALORIFUGEE
HEAT INSULATED PIPING
 — TUYAUTERIE NON CALORIFUGEE
NO HEAT INSULATED PIPING

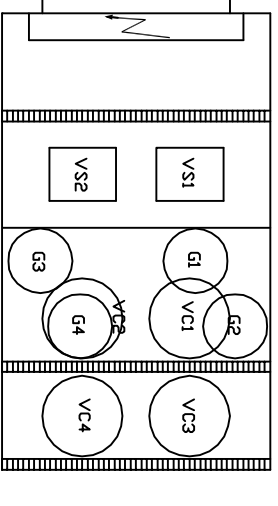

Index	DATE	NOM	MODIFICATIONS
Dessine: RT 34 PC T/Y Date: 25.05.99 SCHEMA FRIGORIFIQUE USINE DE LONGVIC			
215978 12/16			

1	2	3	4	5	6	7	8	9	10	11	12	13	14	15	16	17	18	19	20		
BCD	BATTERIE CONDENSEUR									F7-F8	FUSIBLES DE PROTECTION CIRCUIT PRIMAIRE T3										
BEC	BATTERIE EAU CHAUDE									F9	FUSIBLES DE PROTECTION CIRCUIT SECONDAIRE T3										
BEG	BATTERIE EAU GLACEE									F10-F11	FUSIBLES DE PROTECTION CIRCUIT PRIMAIRE T4										
BEV	BATTERIE EVAPORATEUR									F12	FUSIBLES DE PROTECTION CIRCUIT SECONDAIRE T4										
BF1	DETECTEUR DE FUMEE									G1,2,3,4	COMPRESSEUR G1,2,3,4										
BH11	SONDE D'HYGROMETRIE REGULATION									H1	HORLOGE JOURNALIERE-HEBDOMADAIRE										
BH13	SONDE D'HYGROMETRIE EXTERIEURE									IG	INTERUPTEUR GENERAL										
BT10	SONDE DE TEMPERATURE REGULATION AMBIANCE									K1	RELAIS REARMEMENT RAMPE GAZ N1										
BT12	SONDE DE TEMPERATURE EXTERIEURE									K2	RELAIS REARMEMENT RAMPE GAZ N2										
BT14	SONDE DE TEMPERATURE SOUFFLAGE									KP1	CONTACTEUR POMPE DE CIRCULATION										
BT15	SONDE DE TEMPERATURE EVAPORATION COMPRESSEUR G1									KR1	CONTACTEUR BRULEUR 1										
BT16	SONDE DE TEMPERATURE EVAPORATION COMPRESSEUR G2									KR2	CONTACTEUR BRULEUR 2										
BT17	SONDE DE TEMPERATURE EVAPORATION COMPRESSEUR G3									KCE	CONTACTEUR COUPLAGE ETIOLE										
BT18	SONDE DE TEMPERATURE EVAPORATION COMPRESSEUR G4									KPV1	CONTACTEUR PETITE VITESSE MOTEUR VENTILATEUR SOUFFLAGE 1										
BT19	SONDE DE TEMPERATURE REFOULEMENT COMPRESSEUR G1									KPV2	CONTACTEUR PETITE VITESSE MOTEUR VENTILATEUR SOUFFLAGE 2										
BT20	SONDE DE TEMPERATURE REFOULEMENT COMPRESSEUR G2									KVY1	CONTACTEUR MOTEUR VENTILATEUR SOUFFLAGE 1										
BT21	SONDE DE TEMPERATURE REFOULEMENT COMPRESSEUR G3									KVY2	CONTACTEUR MOTEUR VENTILATEUR SOUFFLAGE 2										
BT22	SONDE DE TEMPERATURE REFOULEMENT COMPRESSEUR G4									KVEX1	CONTACTEUR MOTEUR VENTILATEUR EXTRACTION 1										
BT27	SONDE DE TEMPERATURE EAU FROIDE									KVEX2	CONTACTEUR MOTEUR VENTILATEUR EXTRACTION 2										
BT28	SONDE DE TEMPERATURE EAU CHAUDE									KVC1	CONTACTEUR MOTEUR VENTILATEUR CONDENSEUR 1										
BT44	SONDE ANTIGEL SORTIE EAU ECHANGEUR									KVC2	CONTACTEUR MOTEUR VENTILATEUR CONDENSEUR 2										
BT1-2	BOUTEILLE TAMPON COMPRESSEUR 1-2									KG1	CONTACTEUR COMPRESSEUR 1										
DT	DETENTEUR THERMOSTATIQUE									KG2	CONTACTEUR COMPRESSEUR 2										
24EL	CARTE 24 ENTREES LOGIQUES									KG3	CONTACTEUR COMPRESSEUR 3										
EEH	ECHANGEUR A EAU HORIZONTAL									KG4	CONTACTEUR COMPRESSEUR 4										
EEV	ECHANGEUR A EAU VERTICAL									KR1	CONTACTEUR BATTERIE ELECTRIQUE 1										
EF34	CIRCUIT IMPRIME DETECTEUR DE FUMEE									KR2	CONTACTEUR BATTERIE ELECTRIQUE 2										
EH1-2	RESISTANCE DE CARTER COMPRESSEURS 1-2									MR1	MOTEUR REGISTRE ECONOMISEUR										
EH3-4	RESISTANCE DE CARTER COMPRESSEURS 3,4									MR2	MOTEUR REGISTRE AU SOUFFLAGE										
EHS-6	CORDONS CHAUFFANTS ANTIGEL									MR4	MOTEUR REGISTRE AIR NEUF										
FC0	FILTRE CIRCUIT EAU									MR5	MOTEUR REGISTRE EXTRACTION										
FD	FILTRE DESHYDRATEUR									MM1 811	BOTTIER CONTROLE BRULEUR										
FDB	FILTRE DESHYDRATEUR BOUTEILLE									N1	BORNE NEUTRE CIRCUIT SECONDAIRE T1										
FDW	FILTRE DESHYDRATEUR BI FLOW									N2	BORNE NEUTRE CIRCUIT SECONDAIRE T3										
FUEH1	FUSIBLES DE PROTECTION RESISTANCE DE CARTER									N4	BORNE NEUTRE CIRCUIT SECONDAIRE T4										
FUEHS	FUSIBLES DE PROTECTION CORDONS ANTIGEL									QCC	RACCOR D RAPIDE										
FUG1	FUSIBLES DE PROTECTION COMPRESSEUR 1									QFP1	PROTECTION MAGNETO-THERMIQUE POMPE DE CIRCULATION										
FUG2	FUSIBLES DE PROTECTION COMPRESSEUR 2																				
FUG3	FUSIBLES DE PROTECTION COMPRESSEUR 3									RC...	CIRCUIT RESISTANCE CAPACITE RC										
FUG4	FUSIBLES DE PROTECTION COMPRESSEUR 4									R1	BATTERIE ELECTRIQUE 1										
FUP1	FUSIBLES DE PROTECTION POMPE DE CIRCULATION									R2	BATTERIE ELECTRIQUE 2										
FUR1	FUSIBLES DE PROTECTION BATTERIE ELECTRIQUE 1									RDB1	RELAIS DEFAUT BRULEUR 1										
FUR2	FUSIBLES DE PROTECTION BATTERIE ELECTRIQUE 2									RDB2	RELAIS DEFAUT BRULEUR 2										
FUYC1	FUSIBLES DE PROTECTION MOTEUR VENTILATEUR CONDENSEUR 1										RESERVEE LIQUIDE										
FUYC2	FUSIBLES DE PROTECTION MOTEUR VENTILATEUR CONDENSEUR 2									RL											
FUYEX1	FUSIBLES DE PROTECTION MOTEUR VENTILATEUR EXTRACTION 1									RTTH	RELAIS MARCHE BRULEUR 1,2										
FUYEX2	FUSIBLES DE PROTECTION MOTEUR VENTILATEUR EXTRACTION 2									RP1	POTENTIOMETRE DE DECALAGE DE TEMPERATURE										
FUVS1	FUSIBLES DE PROTECTION MOTEUR VENTILATEUR SOUFFLAGE 1									RP2	POTENTIOMETRE DE DECALAGE DU MINIMUM D'AIR NEUF										
FUVS2	FUSIBLES DE PROTECTION MOTEUR VENTILATEUR SOUFFLAGE 2									SAT	SOUPAPE D'ARRET										
F1-F2	FUSIBLES DE PROTECTION CIRCUIT PRIMAIRE T1																				
F3	FUSIBLES DE PROTECTION CIRCUIT SECONDAIRE T1									SBI	ARRET D'URGENCE										
F4-F5	FUSIBLES DE PROTECTION CIRCUIT PRIMAIRE T2									SD1,2	CONTROLEUR DEBIT D'EAU CIRCUIT 1+2										

RT 34 PC

LEGENDE DE REPERES

Designe: T/Y

Date: 25.05.99

USINE DE LONGVIC

215978

13/16

1	2	3	4	5	6	7	8	9	10	11	12	13	14	15	16	17	18	19	20
ST1	THERMOSTAT INCENDIE									SP31	PRESSOSTAT CONTROLE HAUTE PRESSION COMPRESSEUR 1								
ST2	KLIXON SECURITE BATTERIE ELECTRIQUE 1									SP32	PRESSOSTAT CONTROLE HAUTE PRESSION COMPRESSEUR 2								
ST3	KLIXON SECURITE BATTERIE ELECTRIQUE 2									SP33	PRESSOSTAT CONTROLE HAUTE PRESSION COMPRESSEUR 3								
ST4	KLIXON SECURITE BATTERIE ELECTRIQUE 3									SP34	PRESSOSTAT CONTROLE HAUTE PRESSION COMPRESSEUR 4								
ST5	STOPTHERME MOTEUR VENTILATEUR SOUFLAGE VS1																		
ST6	STOPTHERME MOTEUR VENTILATEUR SOUFLAGE VS2																		
ST7	STOPTHERME MOTEUR VENTILATEUR EXTRACTION VEX1																		
ST8	STOPTHERME MOTEUR VENTILATEUR EXTRACTION VEX2																		
ST9	KLIXON DE SECURITE BATTERIE ELECTRIQUE 5 (HORS FOURNITURE)																		
ST10	THERMOSTAT SUR AIR EXTERIEUR									TA1	TRANSFORMATEUR D'ALLUMAGE RAMPE GAZ 1								
ST11	MODULE DE PROTECTION COMPRESSEUR SCROLL 1									TA2	TRANSFORMATEUR D'ALLUMAGE RAMPE GAZ 2								
ST12	MODULE DE PROTECTION COMPRESSEUR SCROLL 2									TA3	TRANSFORMATEUR D'ALLUMAGE RAMPE GAZ 3								
ST13	MODULE DE PROTECTION COMPRESSEUR SCROLL 3									THH3	THERMOSTAT HORS GEL BAC								
ST14	MODULE DE PROTECTION COMPRESSEUR SCROLL 4									V2VP	VANNE 2 VOIES PRESSOSTATIQUE								
										V3VP	VANNE 3 VOIES PRESSOSTATIQUE								
										VAM	VANNE D'ARRET MANUELLE								
ST29	KLIXON DE SECURITE DEBIT D'AIR RAMPE GAZ 1									VCI,2,3,4	MOTEUR VENTILATEUR CONDENSEUR 1,2,3,4								
ST30	KLIXON DE SECURITE DEBIT D'AIR RAMPE GAZ 2									VEX1	MOTEUR VENTILATEUR EXTRACTION 1								
ST31	KLIXON DE SECURITE DEBIT D'AIR RAMPE GAZ 3									VEX2	MOTEUR VENTILATEUR EXTRACTION 2								
ST32	KLIXON SECURITE RETOUR FLAMME RAMPE GAZ 1									VINI	MOTEUR VENTILATEUR EXTRACTION FUMEES RAMPE GAZ 1								
ST33	KLIXON SECURITE RETOUR FLAMME RAMPE GAZ 2									VIN2	MOTEUR VENTILATEUR EXTRACTION FUMEES RAMPE GAZ 2								
ST34	KLIXON SECURITE RETOUR FLAMME RAMPE GAZ 3									VIN3	MOTEUR VENTILATEUR EXTRACTION FUMEES RAMPE GAZ 3								
										VL	VOYANT LIQUIDE								
ST36	STOPTHERME MOTEUR VENTILATEUR CONDENSEUR 1									VRM	VANNE DE REGLAGE MANUELLE								
ST37	STOPTHERME MOTEUR VENTILATEUR CONDENSEUR 2									VSI	MOTEUR VENTILATEUR DE SOUFLAGE 1								
ST38	STOPTHERME MOTEUR VENTILATEUR CONDENSEUR 3									VSE	MOTEUR VENTILATEUR DE SOUFLAGE 2								
ST39	STOPTHERME MOTEUR VENTILATEUR CONDENSEUR 4									V/S3	MOTEUR VENTILATEUR DE SOUFLAGE 3								
										VV1	VANNE 3 VOIES EAU GLACEE								
ST40	STOPTHERME MOTEUR POMPE DE CIRCULATION									VV2	VANNE 3 VOIES EAU CHAUDE								
ST41	THERMOSTAT ANTIGEL BATTERIE EAU CHAUDE									VV11-12	VANNE INVERSION CYCLE COMPRESSEURS 1,2								
ST45	KLIXON DE REGULATION RAMPE GAZ 1									VV13-14	VANNE INVERSION CYCLE COMPRESSEURS 3,4								
ST46	KLIXON DE REGULATION RAMPE GAZ 2									VV31	ELECTROVANNE GAZ BRULEUR 1								
ST47	KLIXON DE REGULATION RAMPE GAZ 3									VV32	ELECTROVANNE GAZ BRULEUR 2								
										VV41	ELECTROVANNE SECURITE GAZ RAMPE GAZ 1								
SP1	PRESSOSTAT SECURITE HAUTE PRESSION COMPRESSEUR 1									VV42	ELECTROVANNE SECURITE GAZ RAMPE GAZ 2								
SP2	PRESSOSTAT SECURITE HAUTE PRESSION COMPRESSEUR 2									VV43	ELECTROVANNE SECURITE GAZ RAMPE GAZ 3								
SP3	PRESSOSTAT SECURITE HAUTE PRESSION COMPRESSEUR 3									VV51	ELECTROVANNE PRINCIPAL GAZ RAMPE GAZ 1								
SP4	PRESSOSTAT SECURITE HAUTE PRESSION COMPRESSEUR 4									VV52	ELECTROVANNE PRINCIPAL GAZ RAMPE GAZ 2								
SP5	PRESSOSTAT SECURITE HAUTE PRESSION COMPRESSEUR 4									VV53	ELECTROVANNE PRINCIPAL GAZ RAMPE GAZ 3								
SP6	PRESSOSTAT DEBIT D'AIR																		
SP7	PRESSOSTAT MINI GAZ RAMPE 1									VV61	ELECTROVANNE INJECTION GAZ CHAUD COMPRESSEUR 1								
SP8	PRESSOSTAT MINI GAZ RAMPE 2									VV62	ELECTROVANNE INJECTION GAZ CHAUD COMPRESSEUR 2								
SP9	PRESSOSTAT MINI GAZ RAMPE 3																		
SP11	PRESSOSTAT DE SECURITE BASSE PRESSION COMPRESSEUR G1																		
SP12	PRESSOSTAT DE SECURITE BASSE PRESSION COMPRESSEUR G2																		
SP13	PRESSOSTAT DE SECURITE BASSE PRESSION COMPRESSEUR G3																		
SP14	PRESSOSTAT DE SECURITE BASSE PRESSION COMPRESSEUR G4																		
SP21	PRESSOSTAT/VAIR EXTRACTION FUMEES RAMPE GAZ 1																		
SP22	PRESSOSTAT/VAIR EXTRACTION FUMEES RAMPE GAZ 2																		
SP23	PRESSOSTAT/VAIR EXTRACTION FUMEES RAMPE GAZ 3																		

- BORNIER PRINCIPAL
 BORNES SECTIONNABLES
 BORNES RACCORDEMENT CLIENT
- LIAISONS A LA CHARGE DE L'INSTALLATEUR

ATTENTION! TOUS LES CONTACTEURS ET BOBINES RACCORDES SUR SITE A UNE SORTIE CLIMATIC DOIVENT ETRE EQUIPES D'UN CIRCUIT RC

RT 34 PC

LEGENDE DE REPERES

Designe: T/Y

Date: 25.05.99



USINE DE LONGVIC

215978

14/16

1	2	3	4	5	6	7	8	9	10	11	12	13	14	15	16	17	18	19	20		
BGD	CONDENSER BATTERY									F7-F8	PRIMARY CIRCUIT PROTECTION FUSES T3										
BEG	CHILLED WATER BATTERY									F9	SECONDARY CIRCUIT PROTECTION FUSES T3										
BEG	HOT WATER BATTERY									F10-F11	PRIMARY CIRCUIT PROTECTION FUSES T4										
BEV	EVAPORATOR BATTERY									F12	SECONDARY CIRCUIT PROTECTION FUSES T4										
BF1	SMOKE DETECTOR									G1,2,3,4	COMPRESSOR G1,2,3,4										
BH11	REGULATION HYGROMETRY SENSOR									H1	WEEK-DAY CLOCK										
BH13	EXTERNAL HYGROMETRY SENSOR									IG	MAIN SWITCH										
BT10	AMBIENT REGULATION TEMPERATURE SENSOR									K1	GAS DISTRIBUTOR RESETTNG RELAY N1										
BT12	EXTERNAL TEMPERATURE SENSOR									K2	GAS DISTRIBUTOR RESETTNG RELAY N2										
BT14	BLOWER TEMPERATURE SENSOR									KP1	PUMP MOTOR CONTACTOR										
BT15	COMPRESSOR EVAPORATION TEMPERATURE SENSOR									KR1	BURNER CONTACTOR 1										
BT16	COMPRESSOR EVAPORATION TEMPERATURE SENSOR									KR2	BURNER CONTACTOR 2										
BT17	COMPRESSOR EVAPORATION TEMPERATURE SENSOR									KCE	STAR COUPLING CONTACTOR										
BT18	COMPRESSOR EVAPORATION TEMPERATURE SENSOR									KPV1	BLOWER VENTILATOR MOTOR LOW SPEED CONTACTOR 1										
BT19	COMPRESSOR DISCHARGE TEMPERATURE SENSOR									KPV2	BLOWER VENTILATOR MOTOR LOW SPEED CONTACTOR 2										
BT20	COMPRESSOR DISCHARGE TEMPERATURE SENSOR									KVS1	BLOWER VENTILATOR MOTOR CONTACTOR 1										
BT21	COMPRESSOR DISCHARGE TEMPERATURE SENSOR									KVS2	BLOWER VENTILATOR MOTOR CONTACTOR 2										
BT22	COMPRESSOR DISCHARGE TEMPERATURE SENSOR									KVEX1	EXTRACTION VENTILATOR MOTOR CONTACTOR 1										
BT27	COLD WATER TEMPERATURE SENSOR									KVEX2	EXTRACTION VENTILATOR MOTOR CONTACTOR 2										
BT28	HOT WATER TEMPERATURE SENSOR									KVC1	CONDENSER VENTILATOR MOTOR CONTACTOR 1										
BT44	EXCHANGER WATER OUTLET ANTIFREEZE SENSOR									KVC2	CONDENSER VENTILATOR MOTOR CONTACTOR 2										
BTp1-2	COMPRESSOR BUFFER BOTTLE 1-2									KG1	COMPRESSOR CONTACTOR 1										
DT	THERMOSTATIC EXPANSION VESSEL									KG2	COMPRESSOR CONTACTOR 2										
24EL	24 LOGIC INPUTS CARD									KG3	COMPRESSOR CONTACTOR 3										
EEH	HORIZONTAL WATER EXCHANGER									KG4	COMPRESSOR CONTACTOR 4										
EEV	VERTICAL WATER EXCHANGER									KR1	ELECTRIC BATTERY CONTACTOR 1										
EF34	SMOKE DETECTOR PRINTED CIRCUIT									KR2	ELECTRIC BATTERY CONTACTOR 2										
EH1-2	COMPRESSORS CASING RESISTANCE 1-2									MR1	ECONOMISER DAMPER MOTOR										
EH3-4	COMPRESSORS CASING RESISTANCE 3,4									MR2	BLOWER DAMPER MOTOR										
EHS-6	ANTIFREEZE HEATING CORDS									MR4	NEW AIR DAMPER MOTOR										
FCD	WATER CIRCUIT FILTER									MR5	EXTRACTION DAMPER MOTOR										
FD	DEHYDRATOR FILTER									MM1 811	BURNER CONTROL UNIT										
FDB	BOTTLE DEHYDRATOR FILTER									N1	SECONDARY CIRCUIT NEUTRAL TERMINAL T1										
FDW	TWO FLOW DEHYDRATOR FILTER									N2	SECONDARY CIRCUIT NEUTRAL TERMINAL T3										
FUEH1	CASING RESISTANCE PROTECTION FUSES									N4	SECONDARY CIRCUIT NEUTRAL TERMINAL T4										
FUEH5	ANTIFREEZE CORD PROTECTION FUSES									QCC	QUICK RELEASE CONNECTION										
FUG1	COMPRESSOR PROTECTION FUSES 1									QFP1	CIRCULATION PUMP MAGNETO-THERMAL PROTECTION										
FUG2	COMPRESSOR PROTECTION FUSES 2																				
FUG3	COMPRESSOR PROTECTION FUSES 3									RC...	CAPACITY RESISTANCE CIRCUIT RC										
FUG4	COMPRESSOR PROTECTION FUSES 4									R1	ELECTRIC BATTERY 1										
FUP1	CIRCULATION PUMP PROTECTION FUSES									R2	ELECTRIC BATTERY 2										
FUR1	ELECTRIC BATTERY PROTECTION FUSES 1									RDB1	BURNER FAULT RELAY 1										
FUR2	ELECTRIC BATTERY PROTECTION FUSES 2									RDB2	BURNER FAULT RELAY 2										
FUYC1	CONDENSER VENTILATOR MOTOR PROTECTION FUSES 1									RL	LIQUID TANK										
FUYC2	CONDENSER VENTILATOR MOTOR PROTECTION FUSES 2									RTTH	BURNER OPERATION RELAY 1,2										
FUYEX1	EXTRACTION VENTILATOR MOTOR PROTECTION FUSES 1									RP1	TEMPERATURE SHIFT POTENTIOMETER										
FUYEX2	EXTRACTION VENTILATOR MOTOR PROTECTION FUSES 2									RP2	MINIMUM NEW AIR SHIFT POTENTIOMETER										
FUVS1	BLOWER VENTILATOR MOTOR PROTECTION FUSES 1									SAT	CHECK VALVE										
FUVS2	BLOWER VENTILATOR MOTOR PROTECTION FUSES 2																				
F1-F2	PRIMARY CIRCUIT PROTECTION FUSES T1																				
F3	SECONDARY CIRCUIT PROTECTION FUSES T1									SBI	EMERGENCY STOP										
F4-F5	PRIMARY CIRCUIT PROTECTION FUSES T2									SD1,2	CIRCUIT WATER FLOW RATE CONTROLLER 1+2										

RT 34 PC
REFERENCES LEGEND

Designe: T/Y
Date: 25.05.99



215978
15/16

