

Indice	DATE	NOM	MODIFICATIONS
			
<i>Asda Ballyclare</i>			
(2) FHM 100 N LENNOX UK		Dessine: T/Y Date: 23.11.07	PAGE DE GARDE <div style="border: 1px solid black; padding: 2px;">257462</div> <div style="border: 1px solid black; padding: 2px;">0 / 11</div>

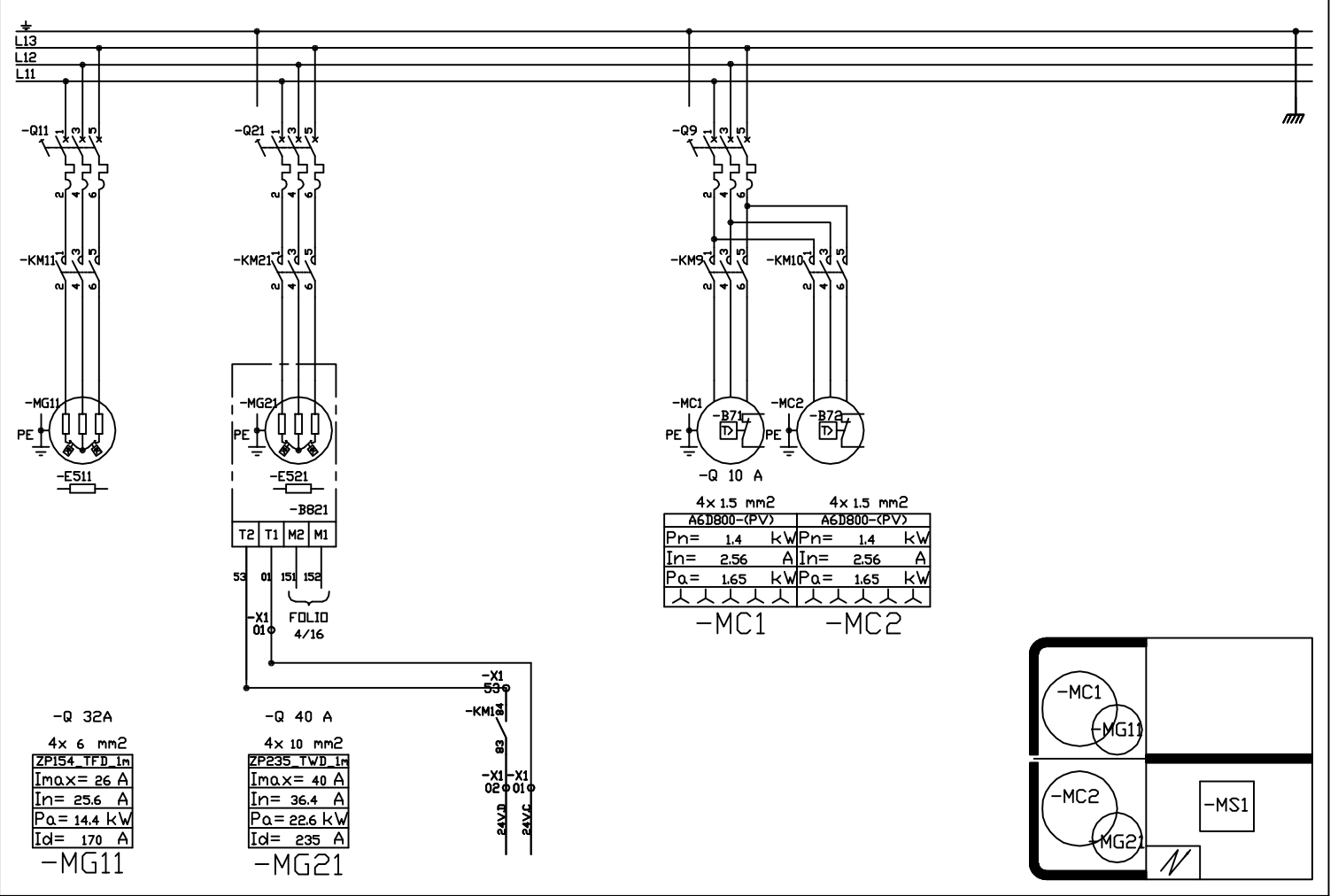

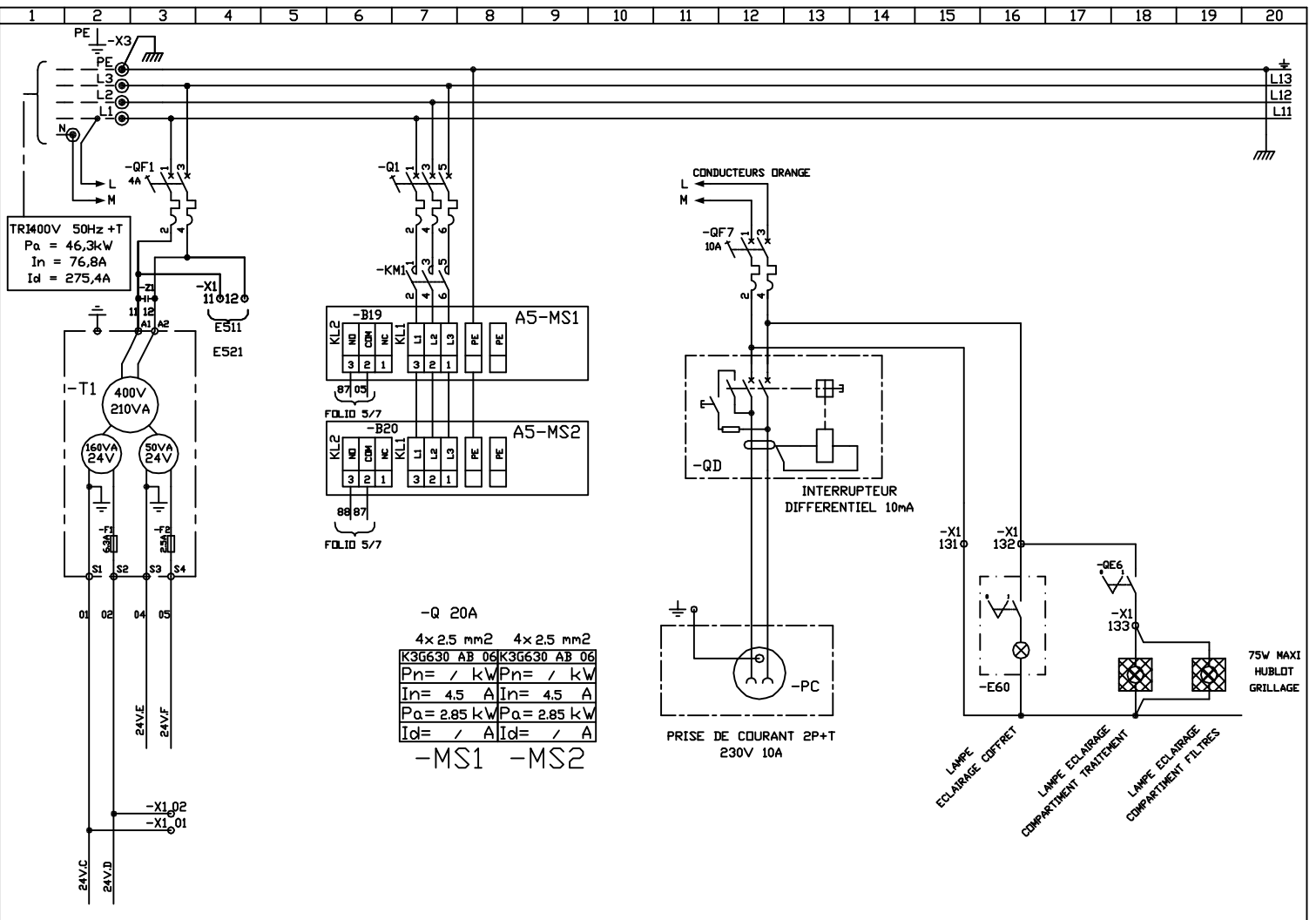

- BM 50

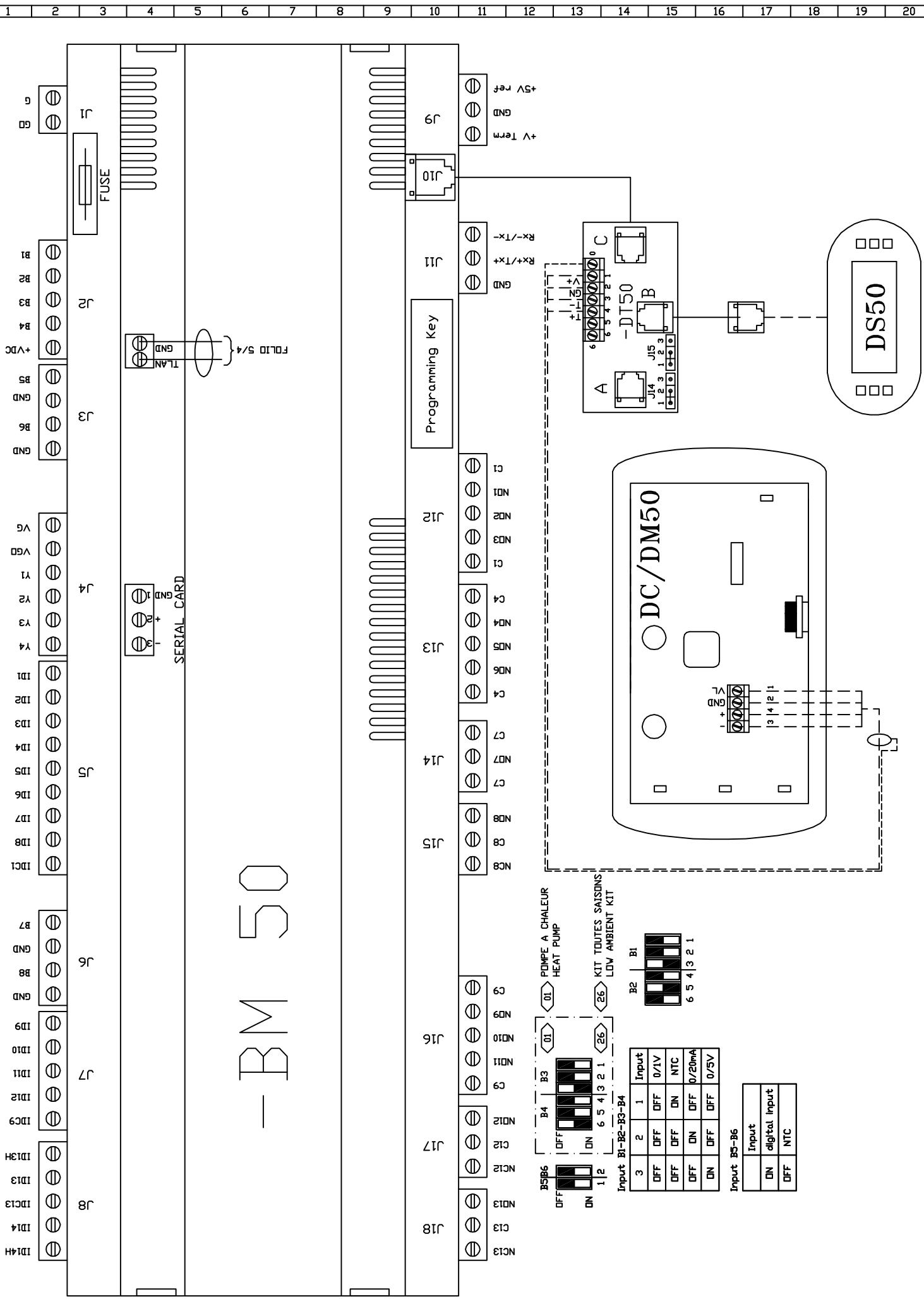
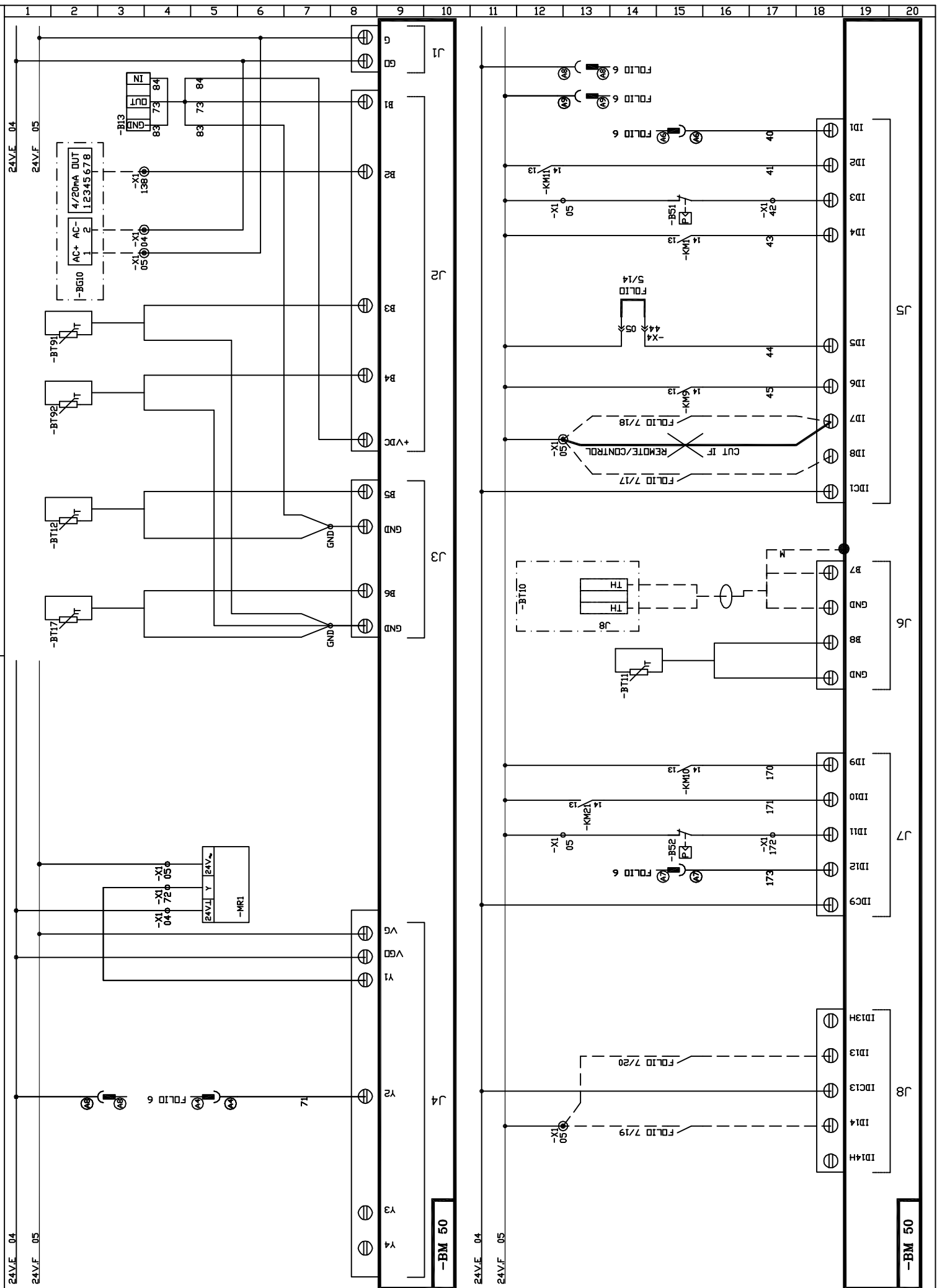

Indice	DATE	NOM	MODIFICATIONS

(2) FHM 100 N
Entrées Automate CLIMATIC 50
Climatic 50 Controller Input

Dessine: T/Y
Date: 23.11.07



257462 3/11

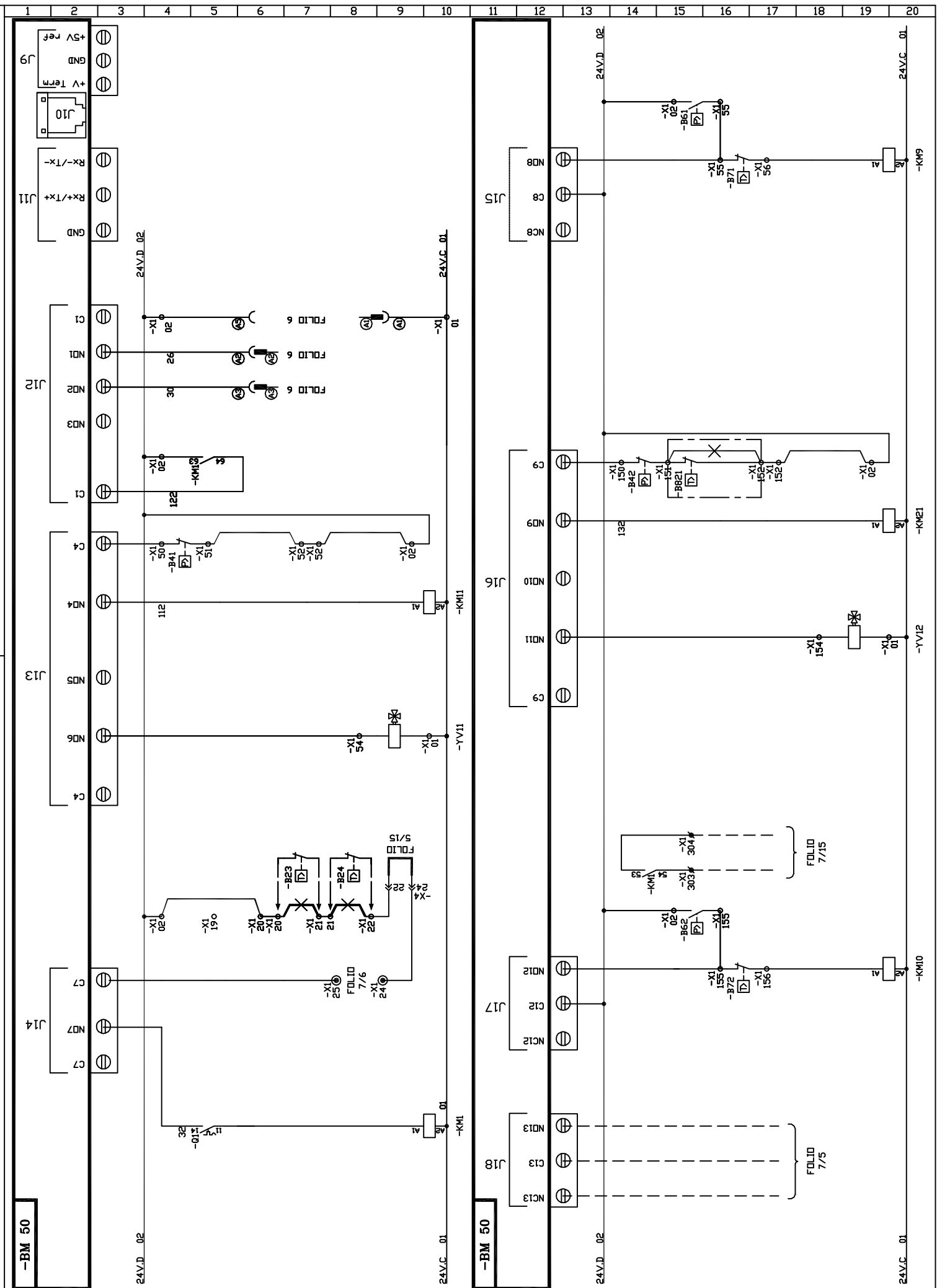

Indice	DATE	NOM	MODIFICATIONS

(2) FHM 100 N
Sorties Automate CLIMATIC 50
CLIMATIC 50 Controller Outputs

Dessine: T/Y
Date: 23.11.07



257462 4/1

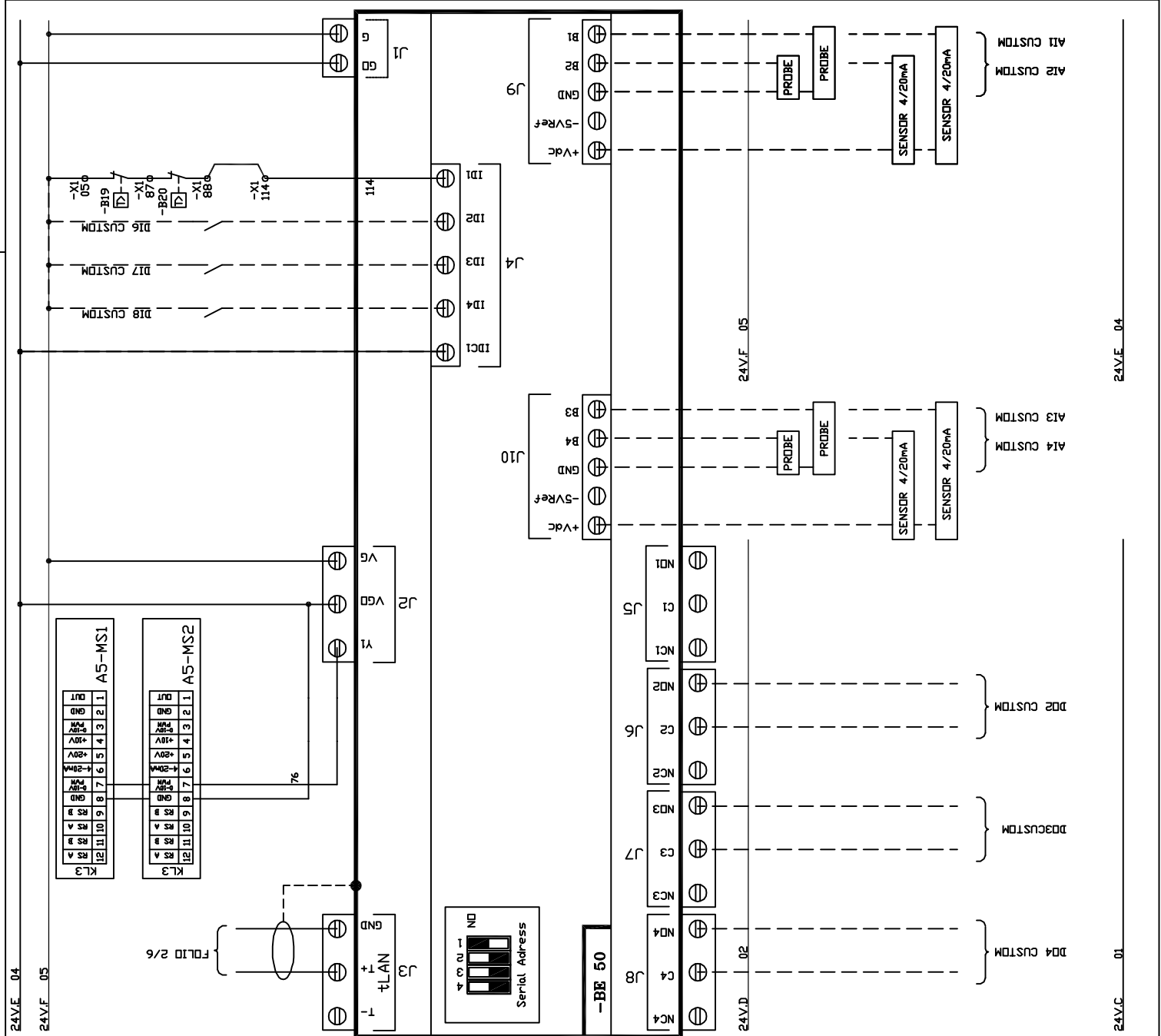
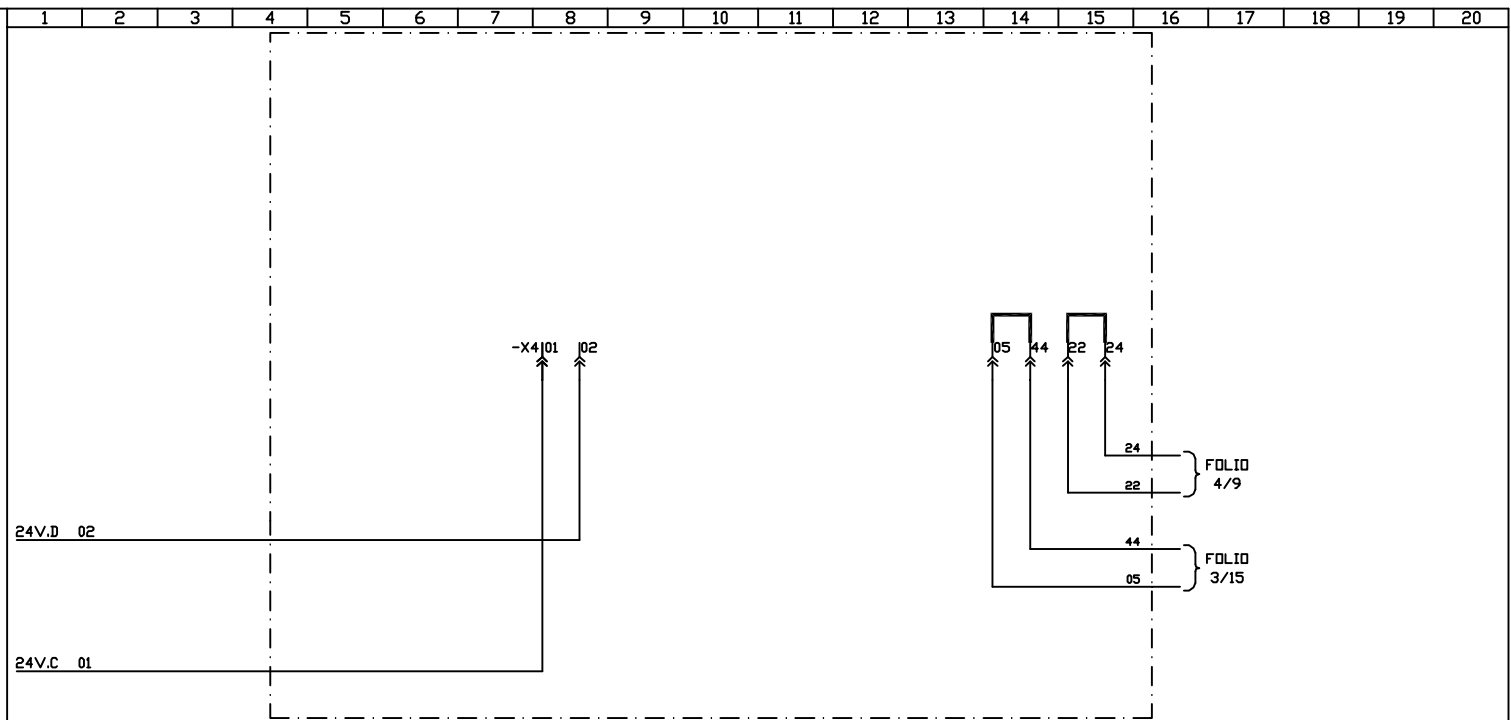

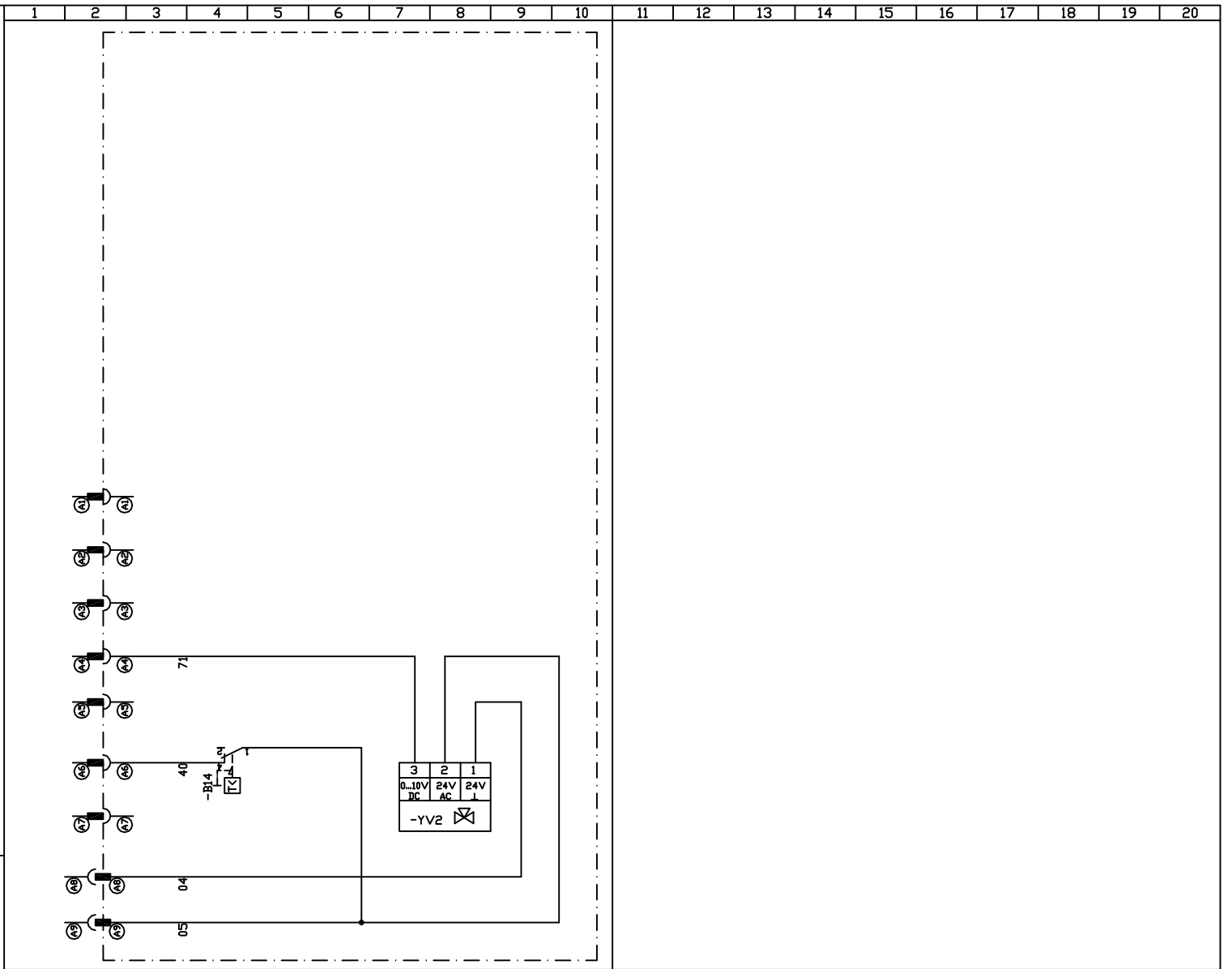

Indice	DATE	NOM	MODIFICATIONS

(2) FHM 100 N
Kit chauffage
GAS

Dessine: T/Y
Date: 23.11.07



257462 6/11

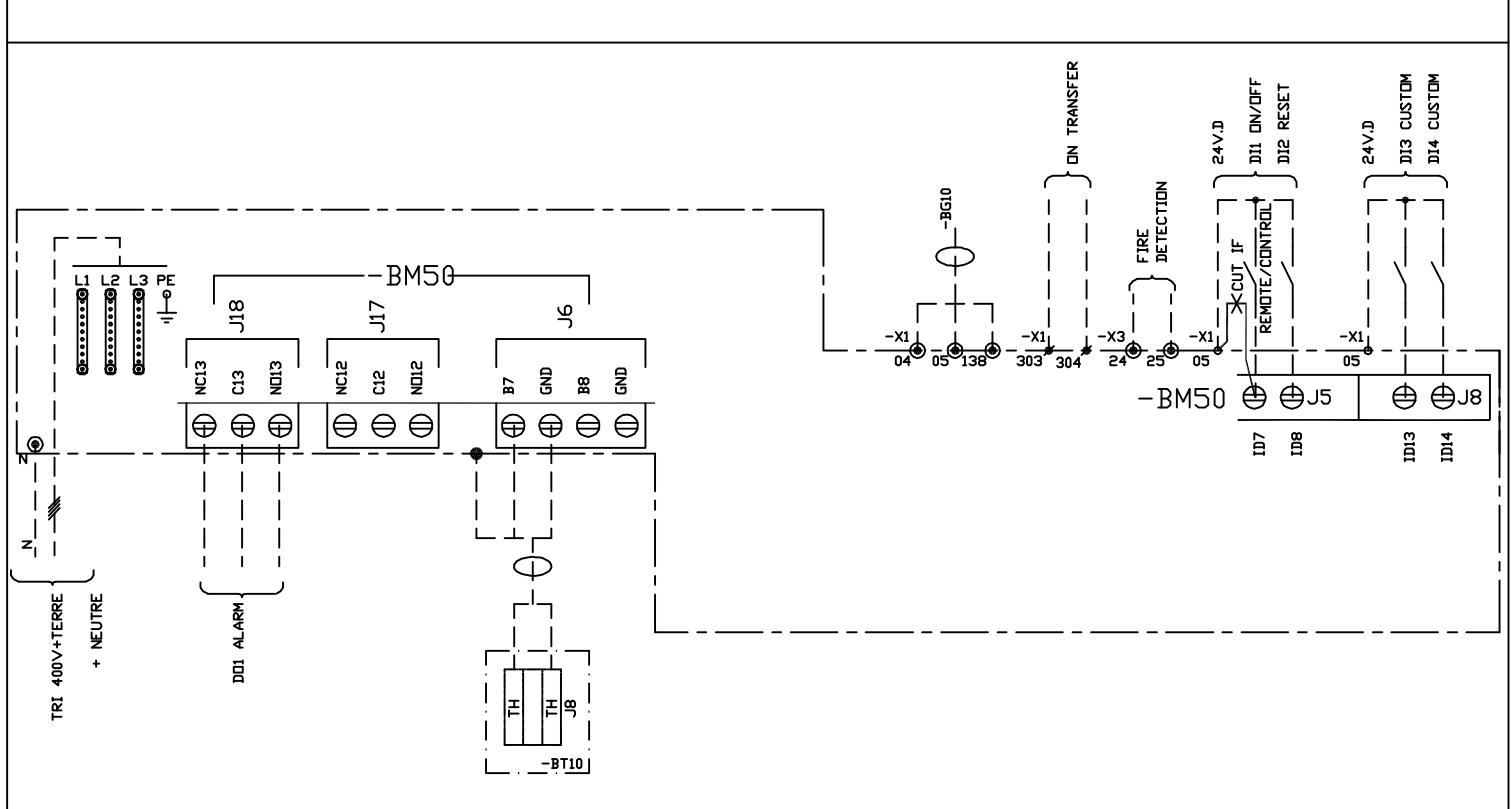
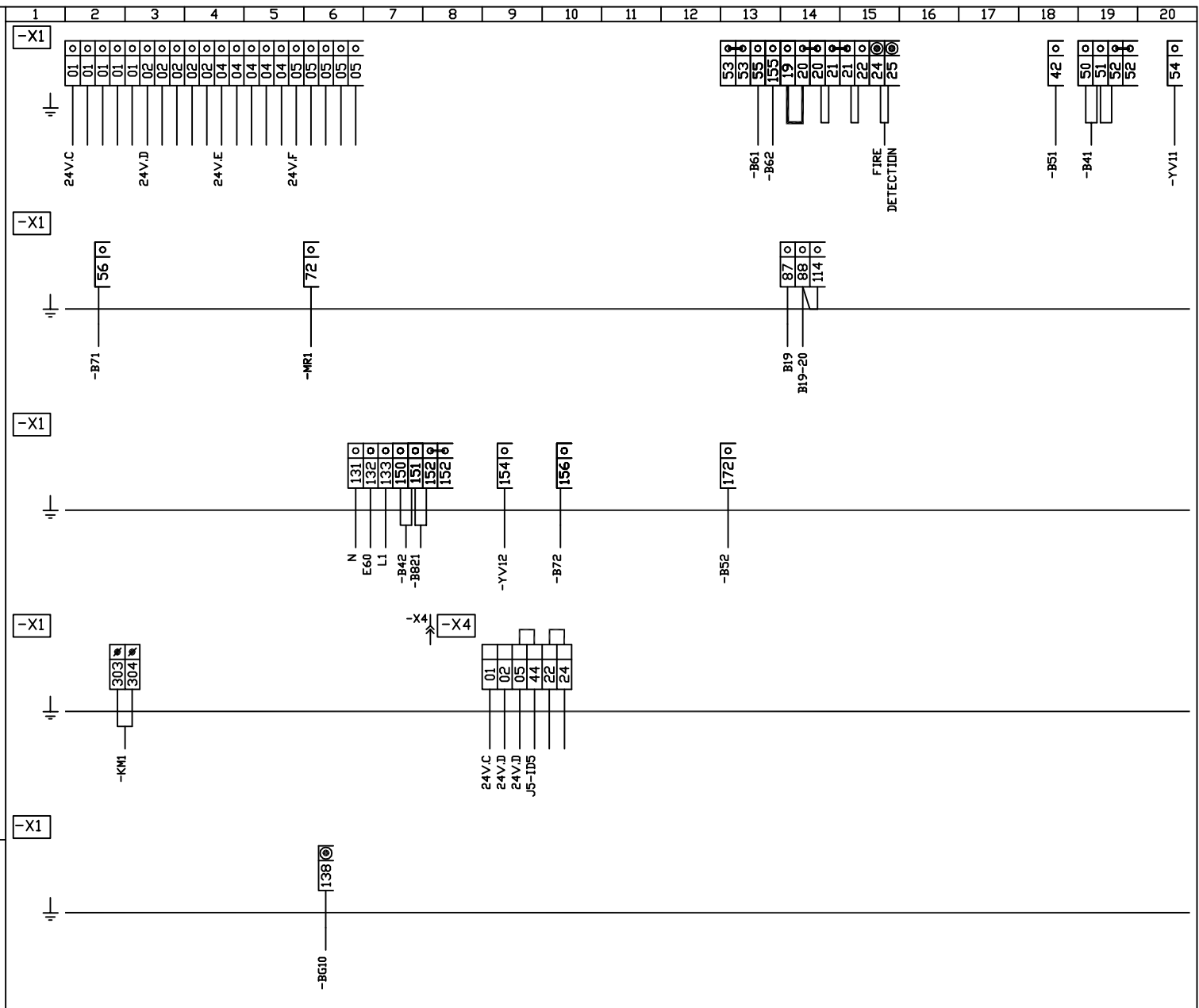

REPERE	REFERENCE	CODE	Nb
-BMS0	CLIMATIC 50	4770607Z	1
-BE50	Extension CLIMATIC 50	4770615M	1
-DT50	-DT50	4770623Y	1
BORNIER	D2.5/5.SNBT.2L DRANGE	5470163K	2
	PLAQUE DE FERMETURE FED5.2L	5470512X	1
	D2.5/5.2L GRISE	5470200N	3
	PLAQUE DE FERMETURE FED5.2L	5470235P	1
	D2.5/5.4L GRISE 24V.C.D	5470270R	16
	PLAQUE DE FERMETURE FED5.4L	5470273V	1
	LIAISON 4 POLES BJDLS.4	5470275Y	2
-Q1	C60N 3P3D 20A D REF:24603	4480497T	1
-Q1	CONTACT AUX. D/F REF:26924	5480156F	1
-KM1	LC1 D1810 B7	4410652F	1
-KM1	LA DN40	5410087M	1
-B13	697 9500010A	4730097A	1
-B13	SUPPORT PLAN N 3172211	4148197R	1
-QF1	C60N 24583 4A BIPOL COURBE D	4480591H	1
-T1	210VA 400V/24V/24V	4430135H	1
-Z1	LRC V2-0.22-220/400V	4770010X	1
-QF7	C60N 24586 10A 2P COURBE D	4480593K	1
-E60	KIT 36312 LEGRAND	64232457A	1
-QE6	PLEXO 91605	64232457F	1
-PC	PC PLEXO f. Britannique	64232457I	1
-QD	INTER. DIFF. 10mA	64232457K	1
-Q11	C60N 32A TRIPOL COURBE D	4480499W	1
-KM11	LC1 D25 B7	4410653H	1
-Q9	C60N 10A TRIPOL COURBE D	4480495P	1
-KM9	LC1 D09 B7	4410650A	1
-Q21	C60N 40A TRIPOL COURBE D	4480500X	1
-KM21	LC1 D32 B7	4410654J	1
-KM10	LC1 D09 B7	4410650A	1

REPERE	REFERENCE	CODE	Nb
BARRETTE	TYPE MG 14979	5470186T	1

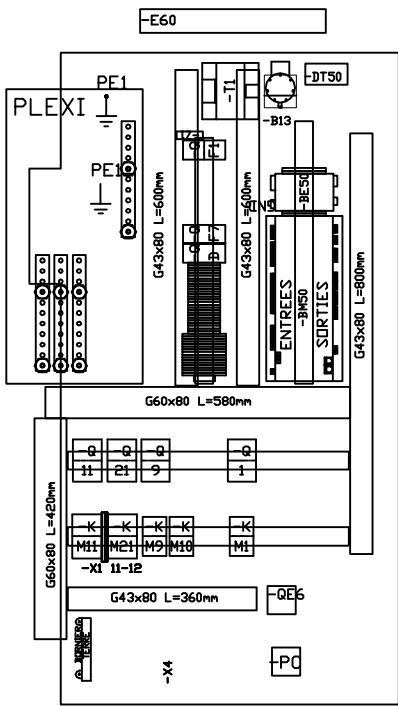

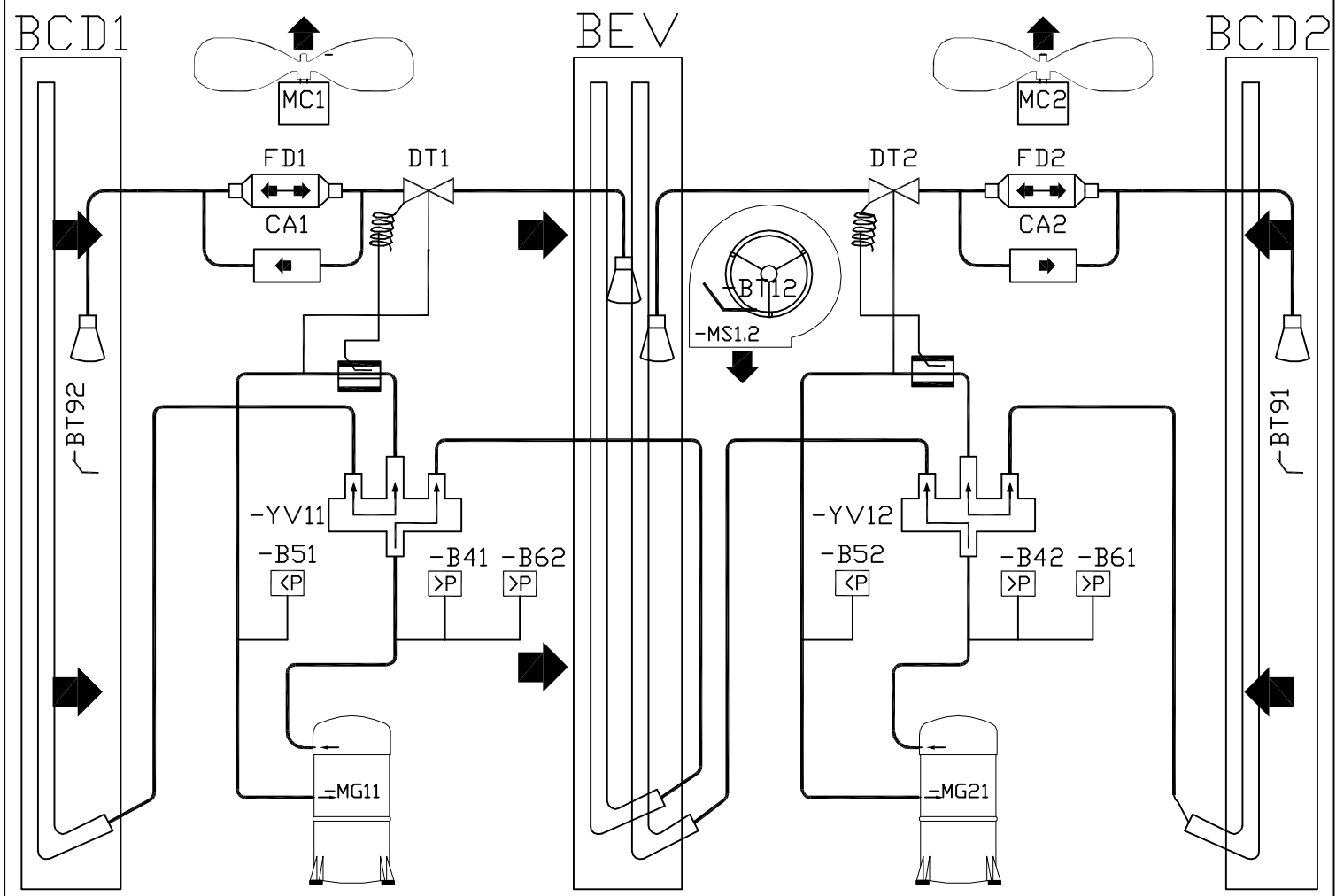
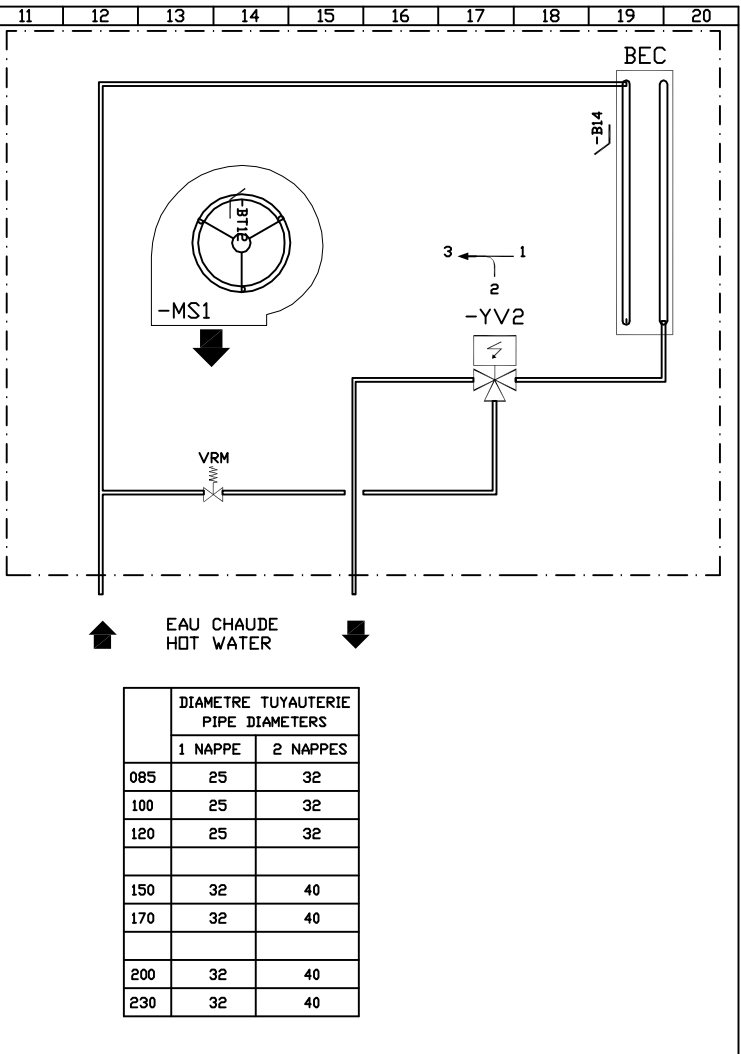
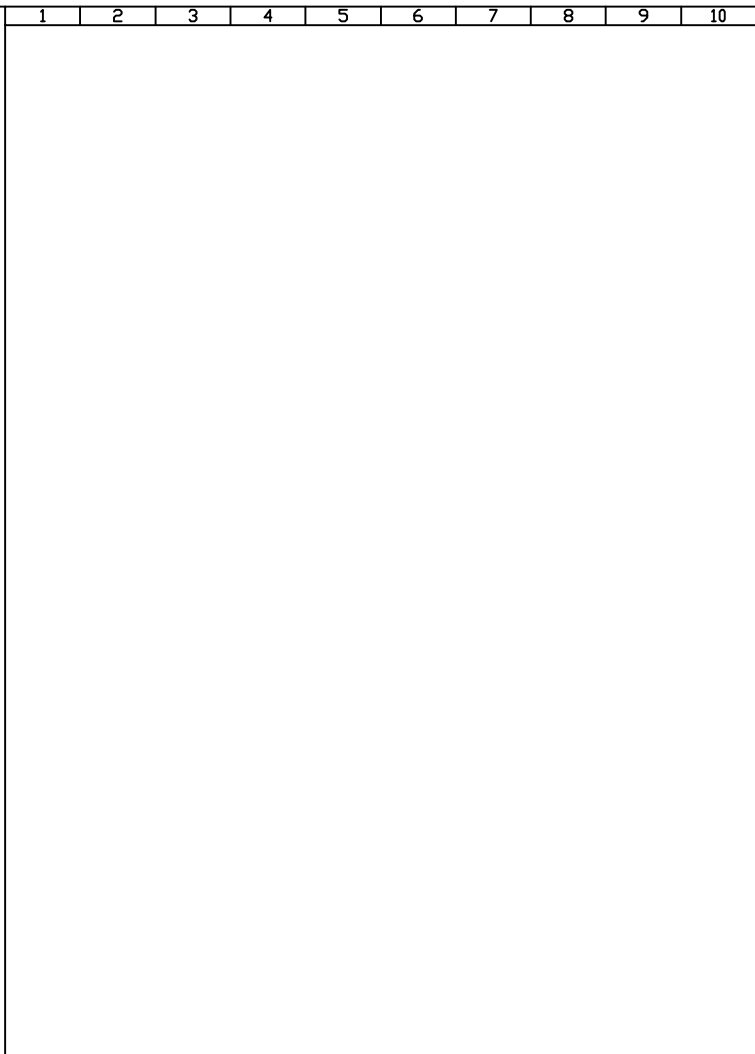

Indice	DATE	NOM	MODIFICATIONS

(2) FHM 100 N
Schéma Frigorifique \ Hydraulique
Cooling \ Hydraulic Diagram

Dessine: T/Y
Date: 23.11.07



257462 9/11

