

(1) FHK 085 N  
Automate CLIMATIC 50  
Climatic 50 Controller

Dessine: CTO  
Date: 02.05.06



247565 2/11

Indice	DATE	NOM	MODIFICATIONS

AVEC TCB SANS CARTE EXTENSION  
WITHOUT EXTENSIONBOARD BE50

Input B1-B2-B3-B4

Input	1	2	3
0/1V	OFF	OFF	OFF
NTC	DN	OFF	OFF
0/20mA	OFF	DN	OFF
0/5V	OFF	OFF	DN

Input B5-B6

Input
digital input
NTC

Input B1-B2-B3-B4

Input	1	2	3
0/1V	OFF	OFF	OFF
NTC	DN	OFF	OFF
0/20mA	OFF	DN	OFF
0/5V	OFF	OFF	DN

Input B5-B6

Input
digital input
NTC

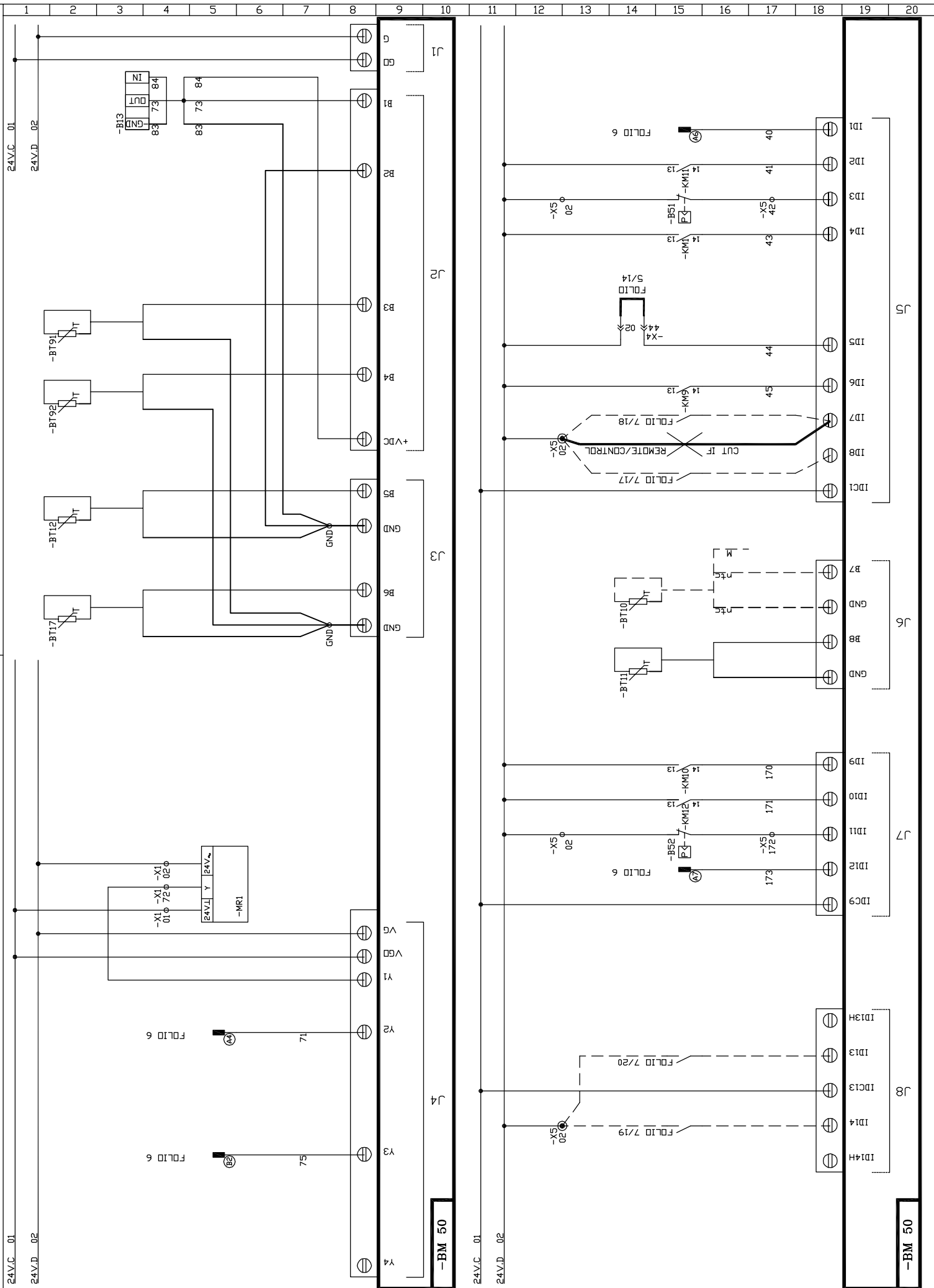

Indice	DATE	NOM	MODIFICATIONS

(1) FHK 085 N  
Entrées Automate CLIMATIC 50  
Climatic 50 Controller Input

Dessine: CTO  
Date: 02.05.06



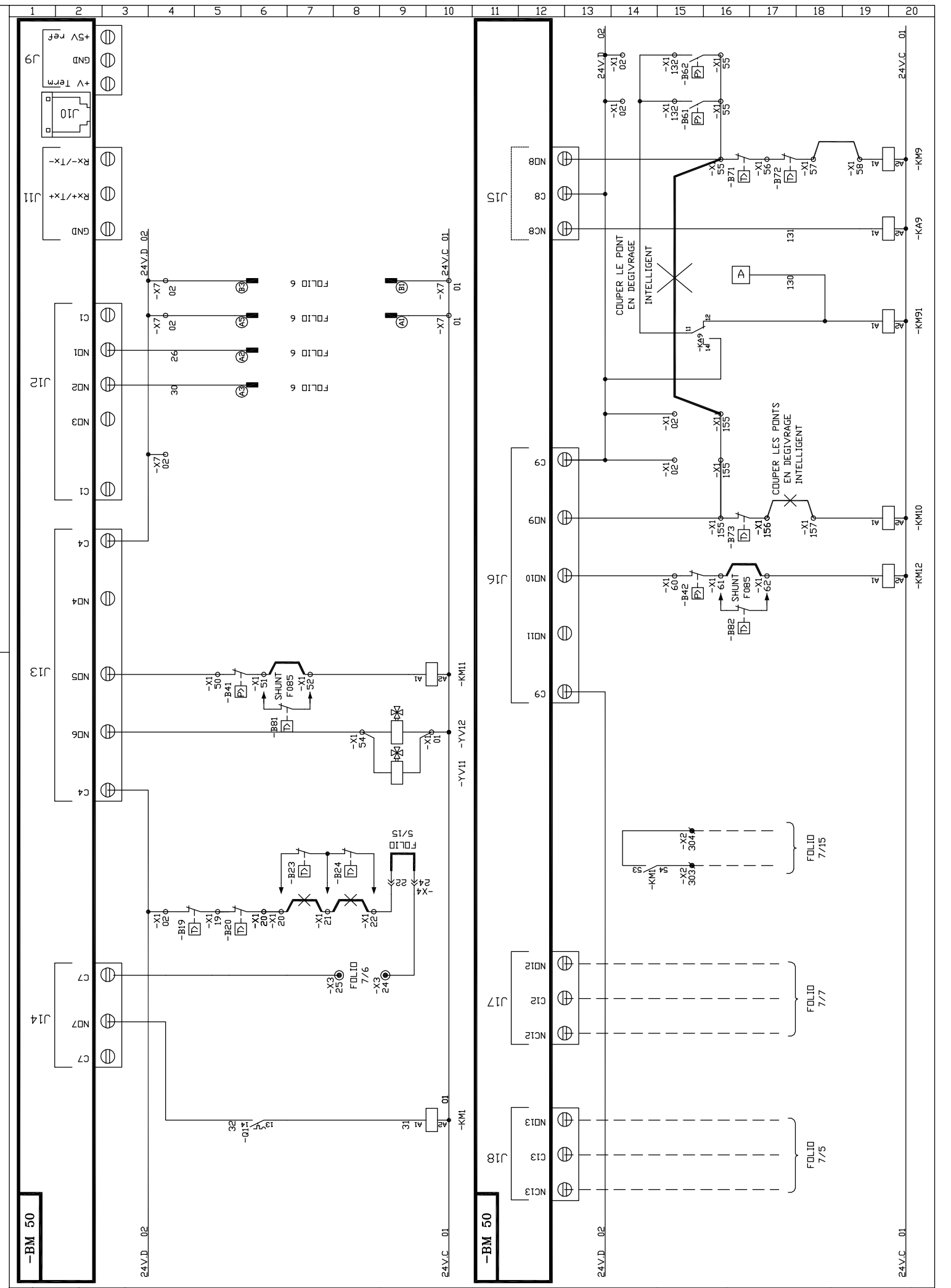

(1) FHK 085 N  
Sorties Automate CLIMATIC 50  
CLIMATIC 50 Controller Outputs

Dessine: CTO  
Date: 02.05.06



247565 4/11

Indice	DATE	NOM	MODIFICATIONS

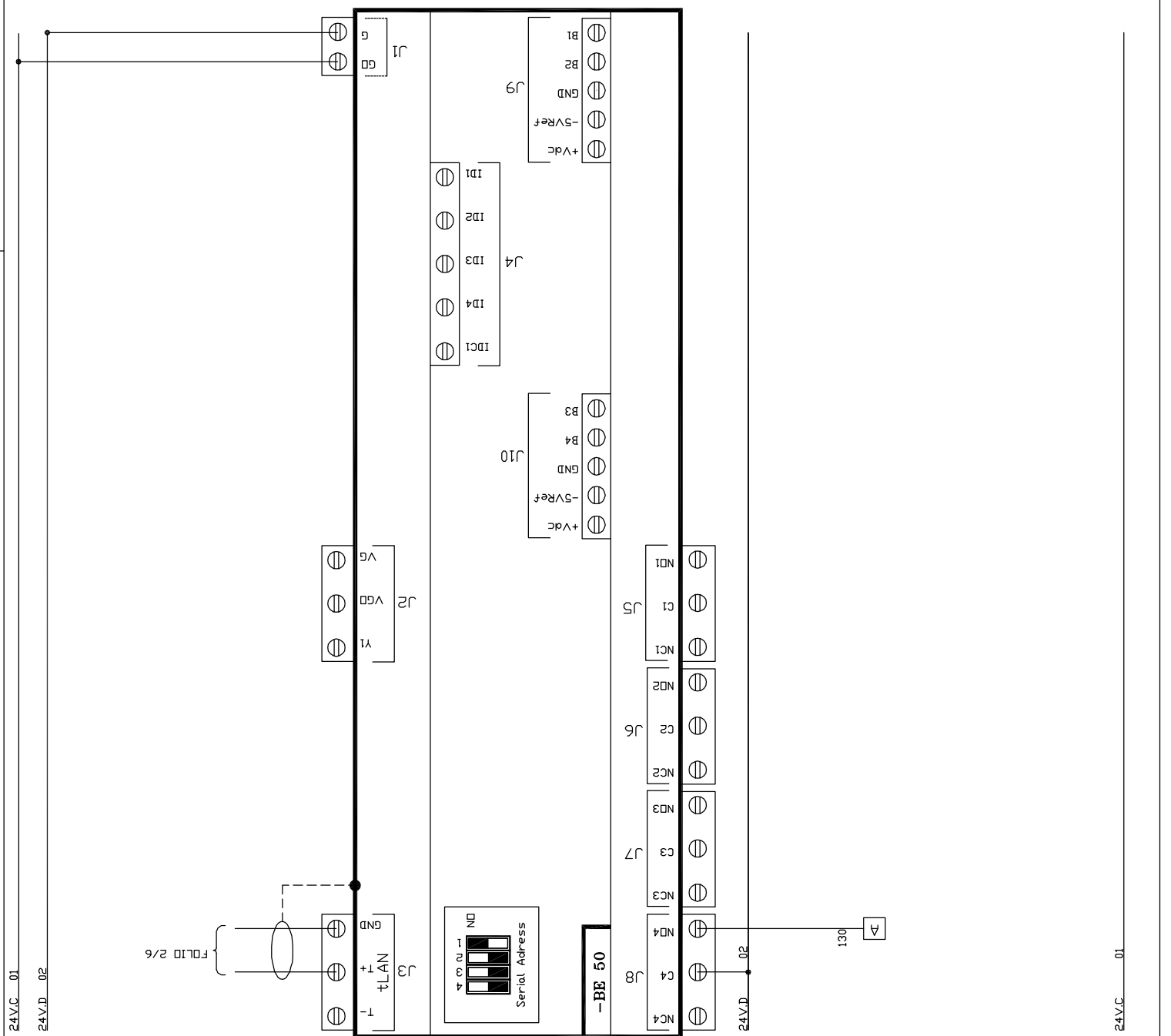
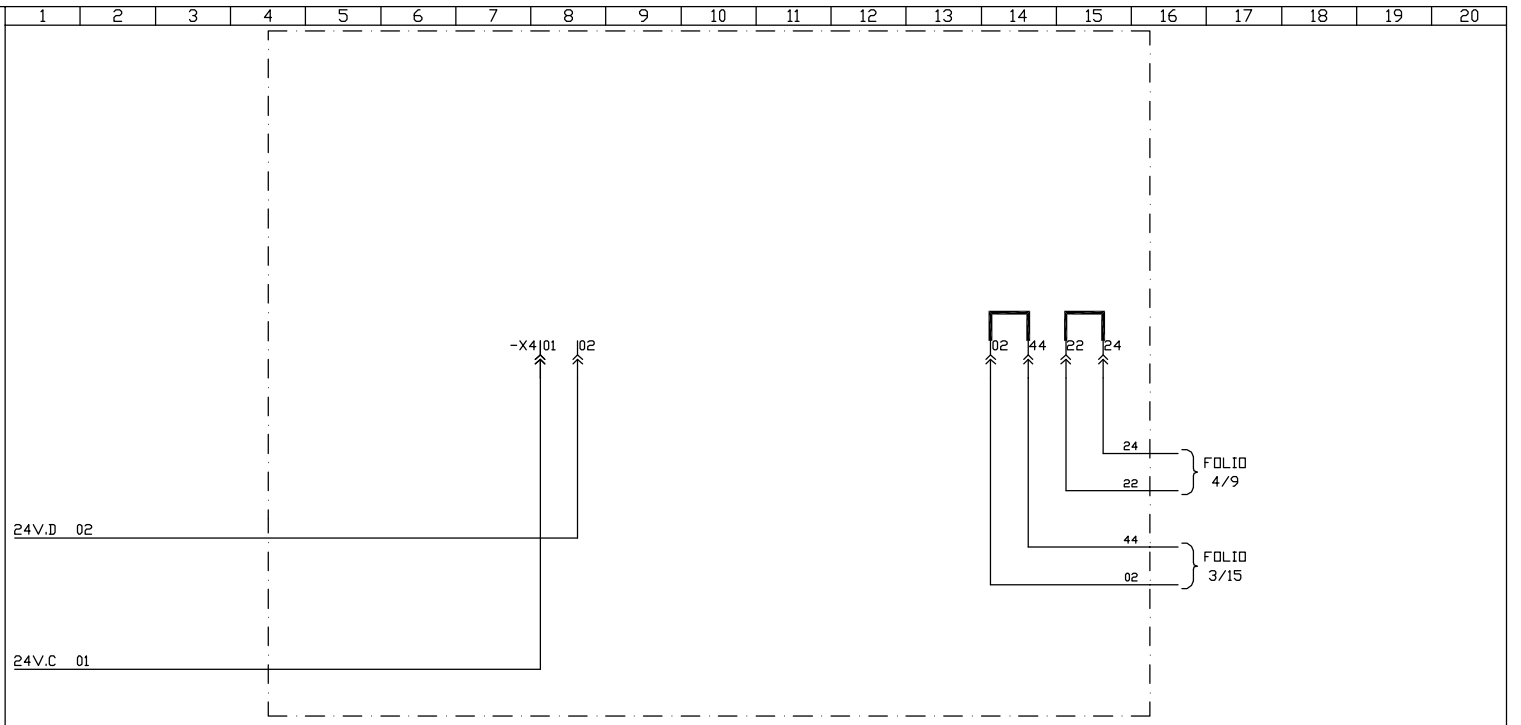

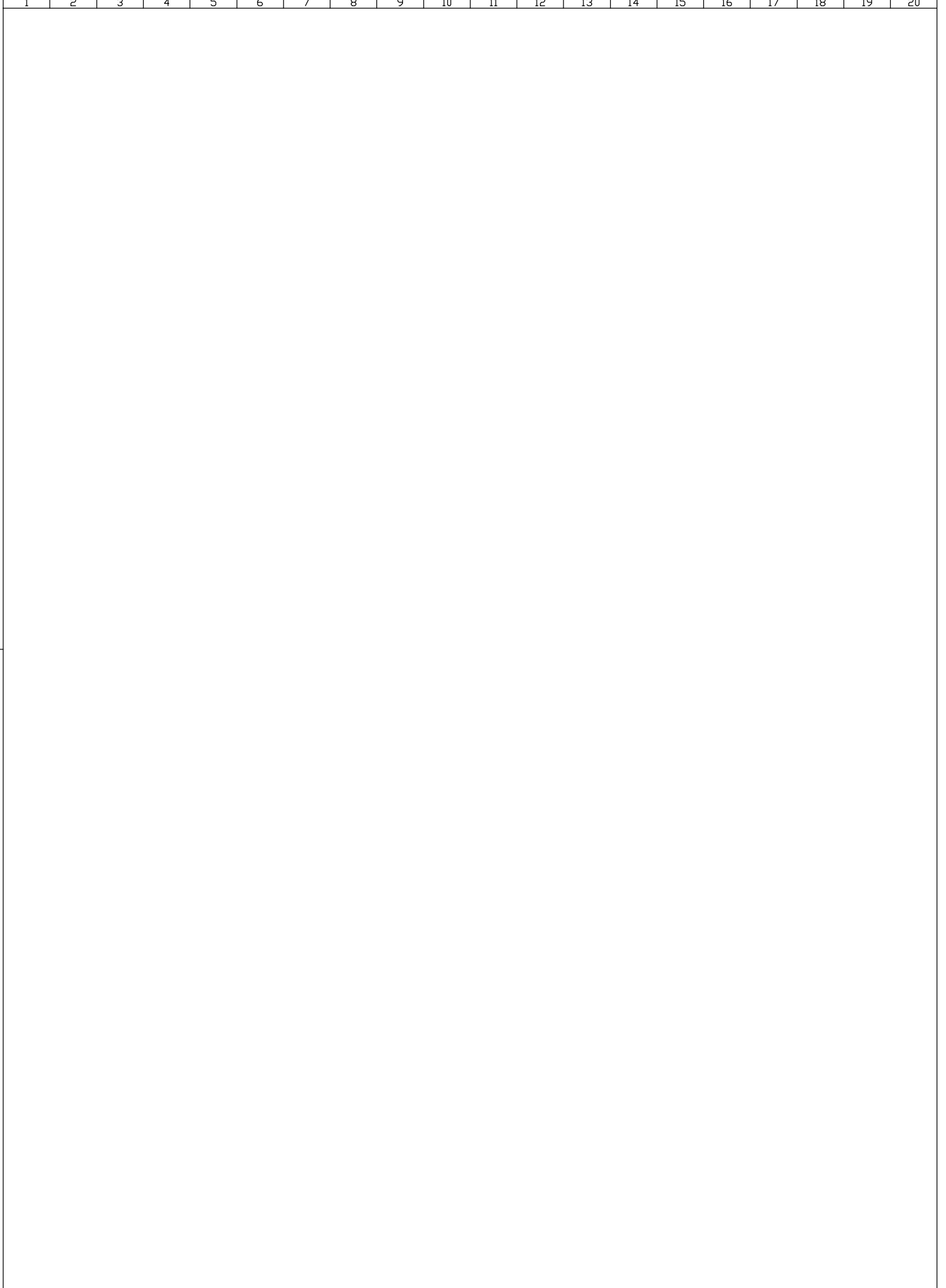

					(1) FHK 085 N Kit chauffage GAS	Dessine: CTO Date: 02.05.06	 USINE DE LONGVIC	247565	6 / 11
Indice	DATE	NOM	MODIFICATIONS						

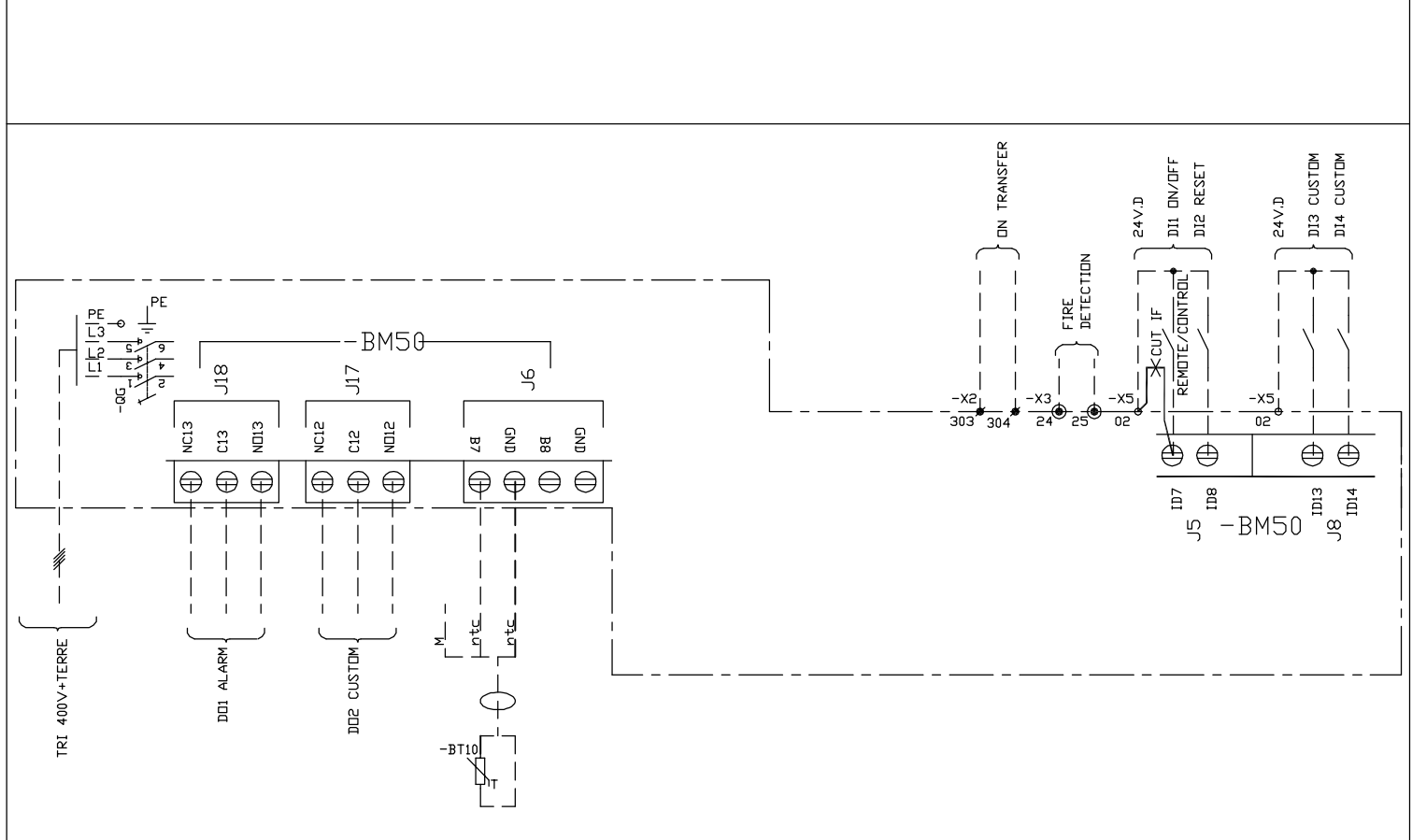
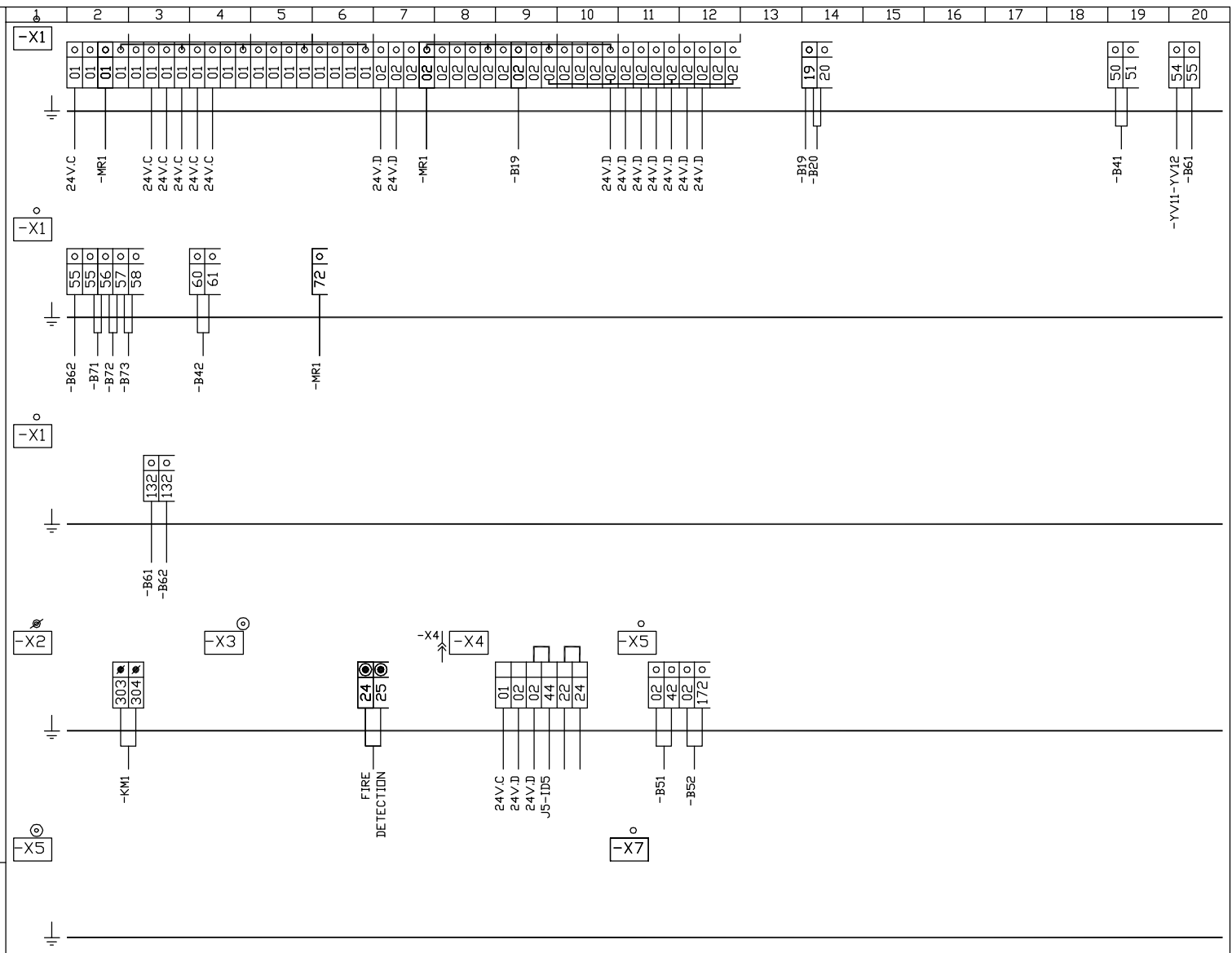





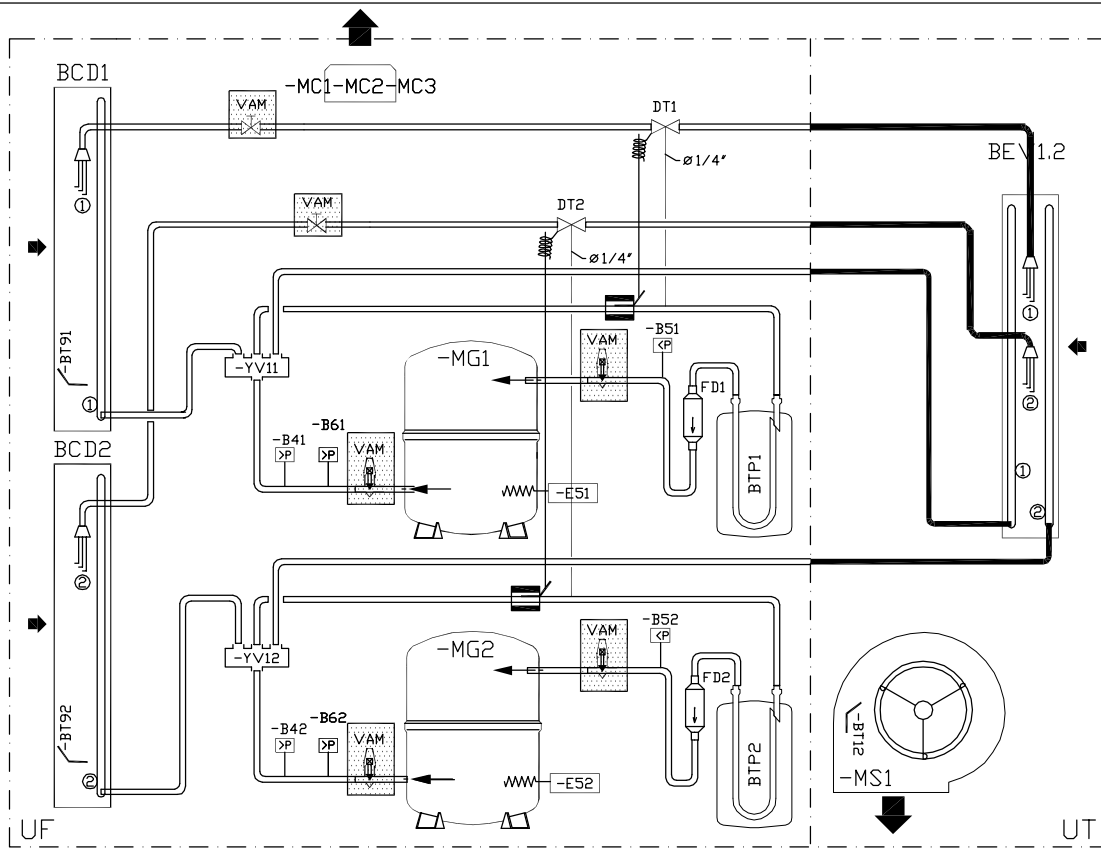

DIAMETRE TUYAUTERIES	
REFOULEMENT	7/8"
ASPIRATION	1"1/8"
LIGNE LIQUIDE	5/8"

TUYAUTERIE CALDRIFUGEE  
 TUYAUTERIE NON CALDRIFUGEE

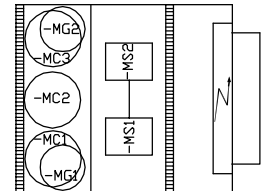
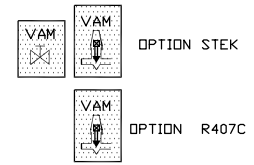

Indice	DATE	NOM	MODIFICATIONS

(1) FHK 085 N  
 Schéma Frigorifique \ Hydraulique  
 Cooling \ Hydraulic Diagram

Dessine: CTO  
 Date: 02.05.06



247565 9/11



