

Indice	DATE	NOM	MODIFICATIONS		
					
<i>Wilkinson Store Southend</i>					
(2) FGM 120 S <b>LENNOX UK</b>		Dessine: CTO Date: 11.01.07	PAGE DE GARDE <table border="1" style="float: right;"> <tr> <td>252686</td> <td>0 / 11</td> </tr> </table>	252686	0 / 11
252686	0 / 11				

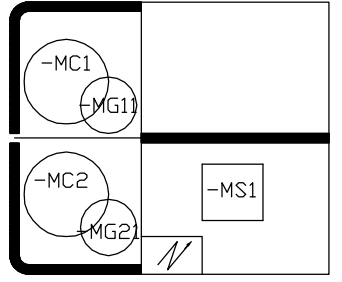

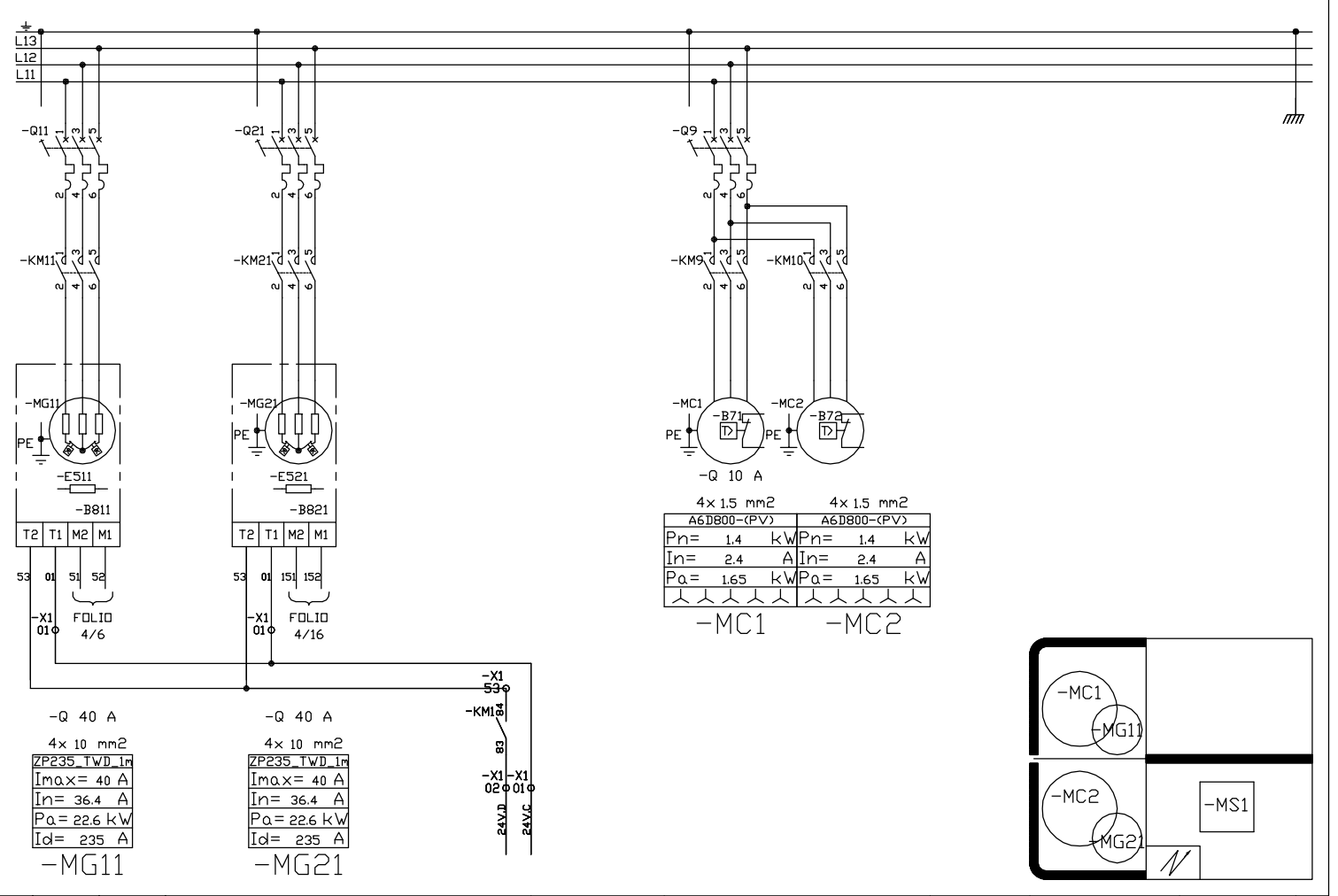

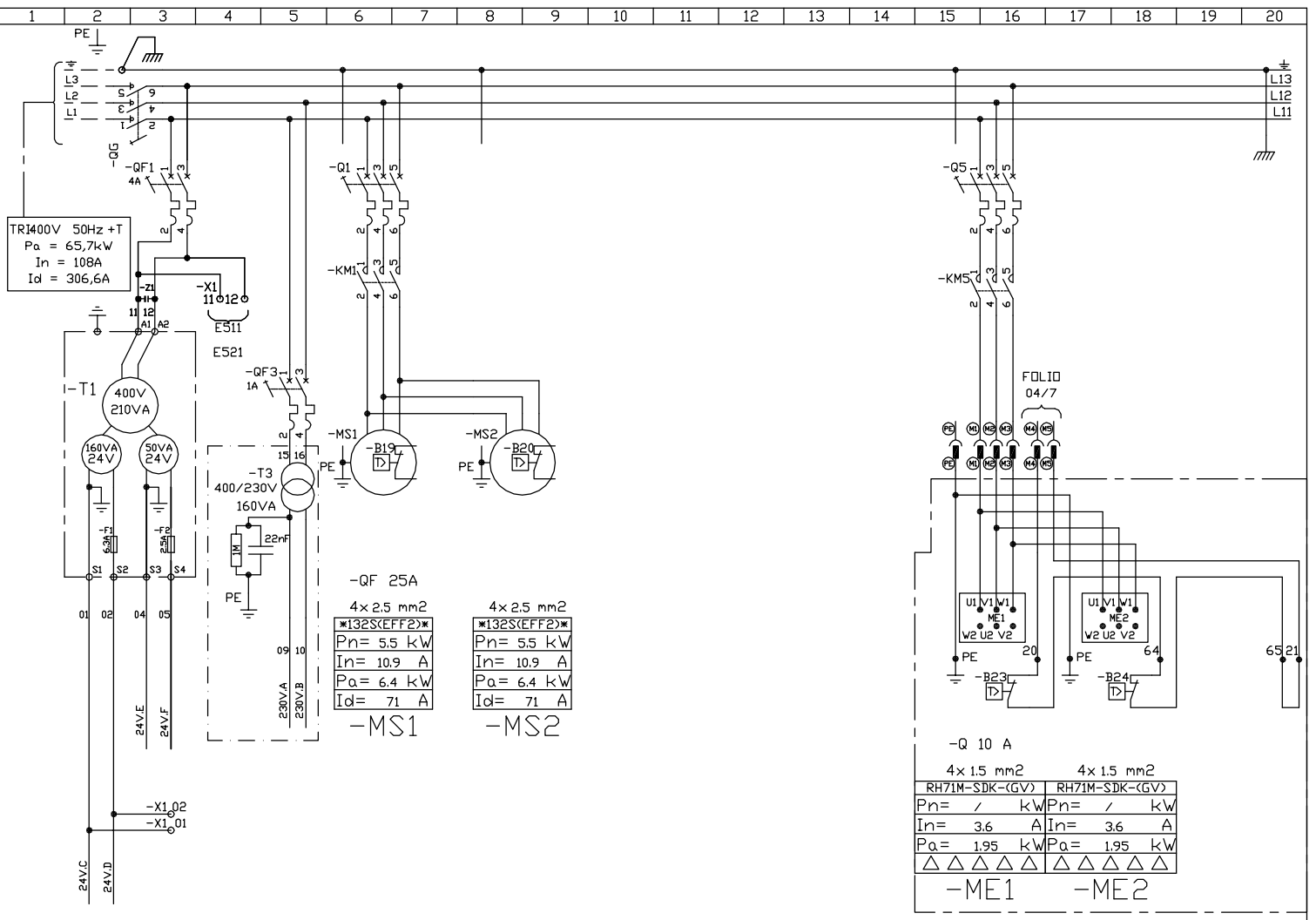
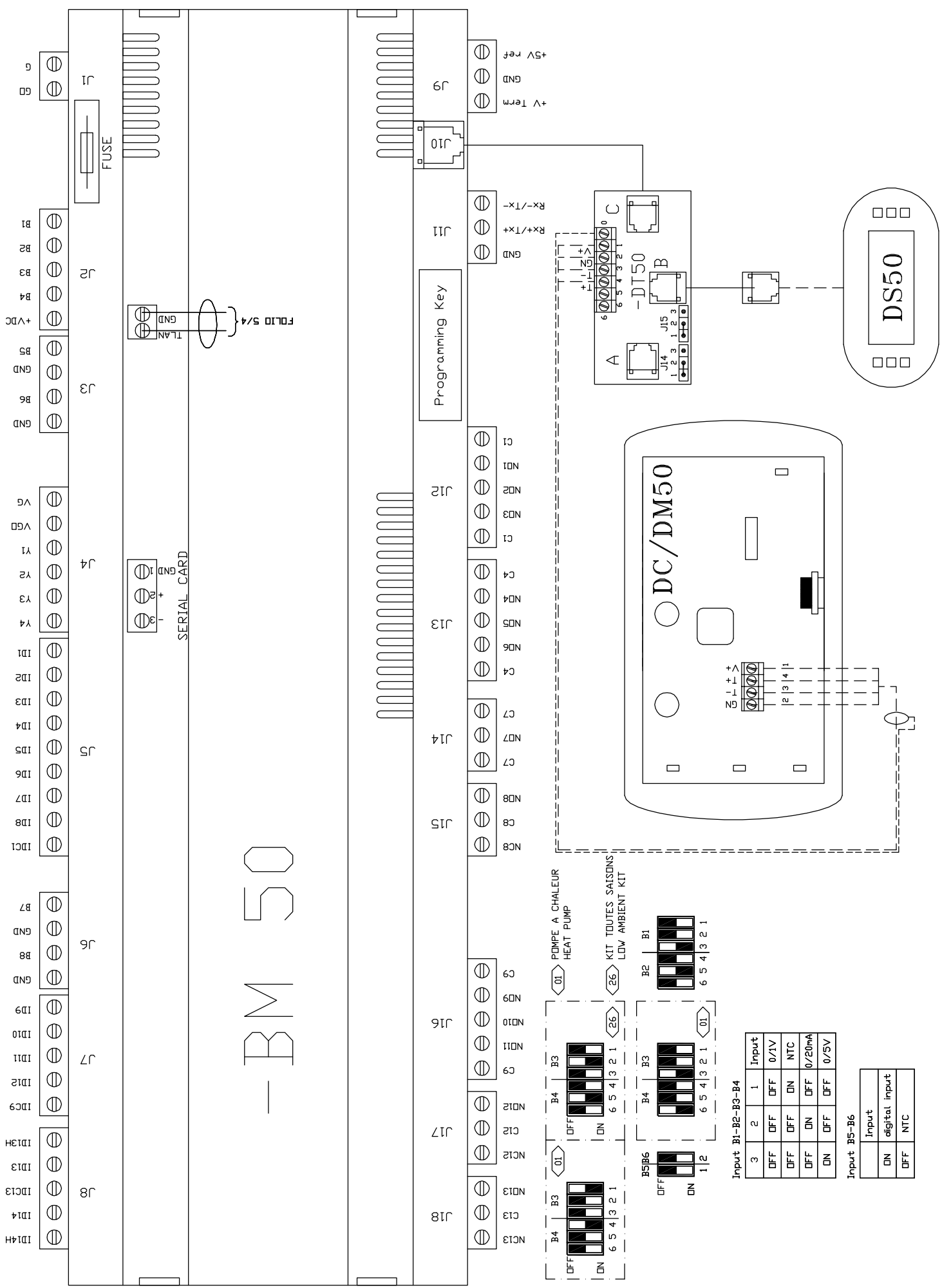
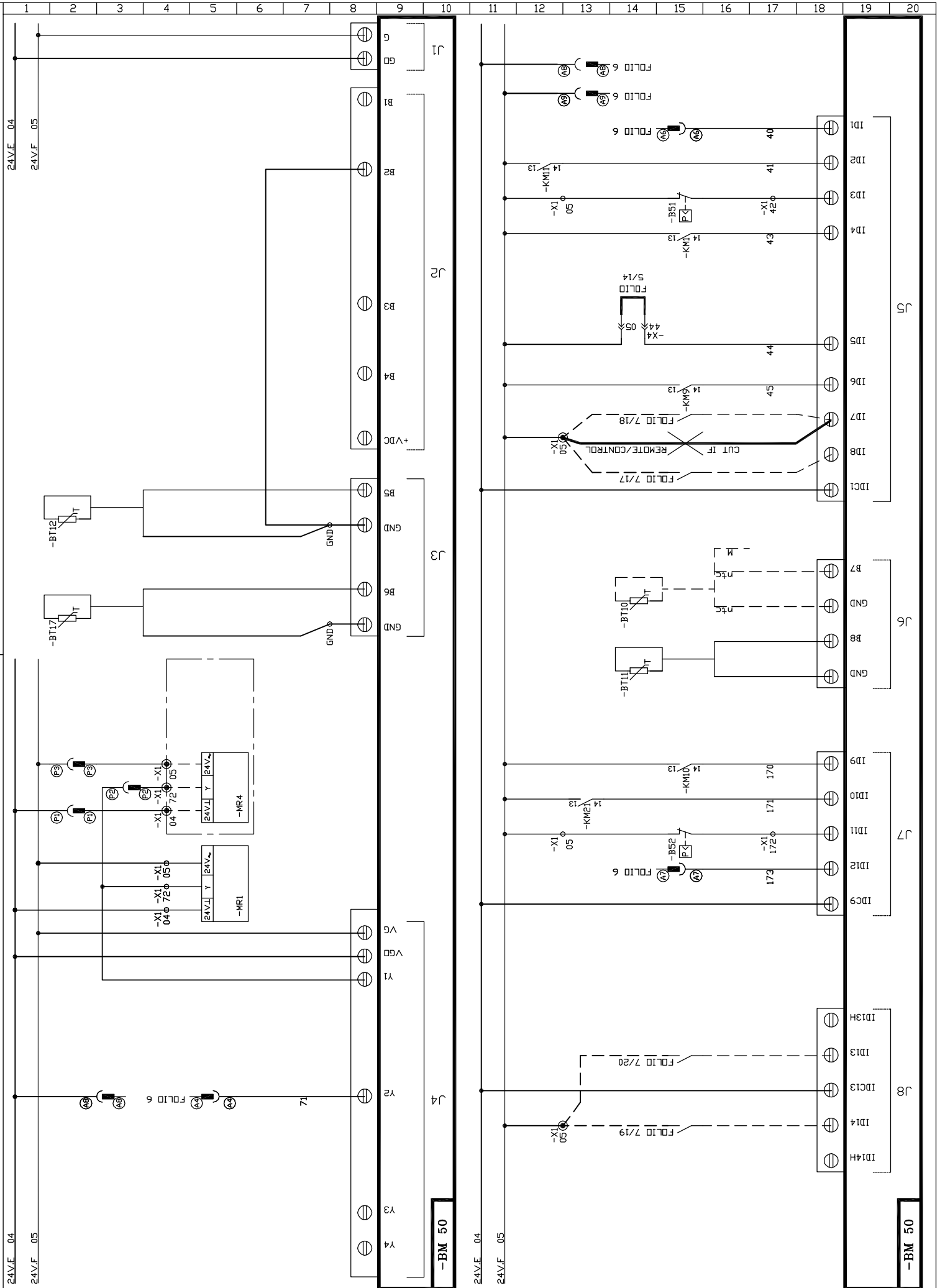

Indice	DATE	NOM	MODIFICATIONS

(2) FGM 120 S  
Entrées Automate CLIMATIC 50  
Climatic 50 Controller Input

Dessine: CTO  
Date: 11.01.07



252686 3/11

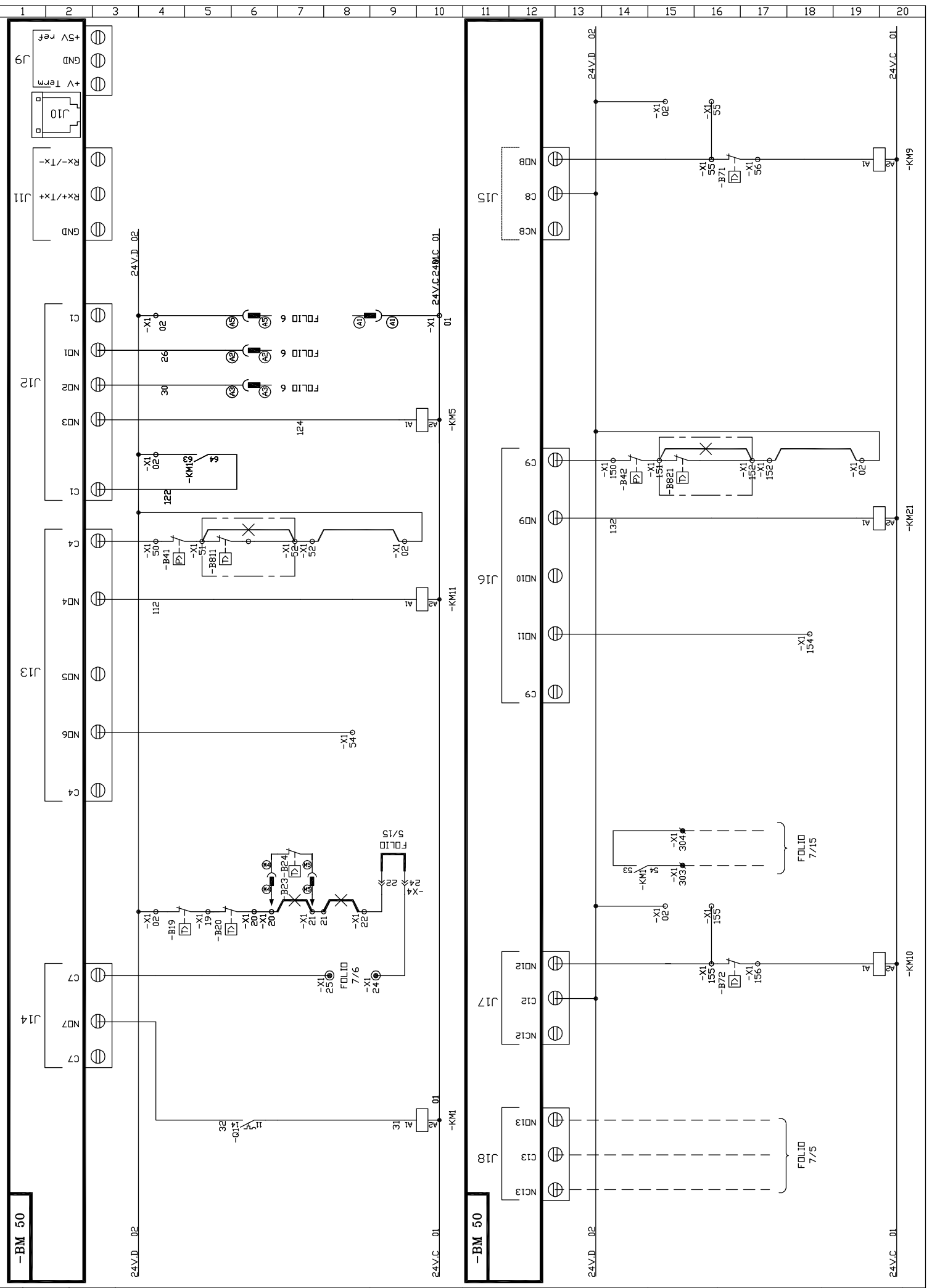

Indice	DATE	NOM	MODIFICATIONS

(2) FGM 120 S  
 Sorties Automate CLIMATIC 50  
 Climatic 50 Controller Outputs

Dessine: CTO  
 Date: 11.01.07



252686 4/11



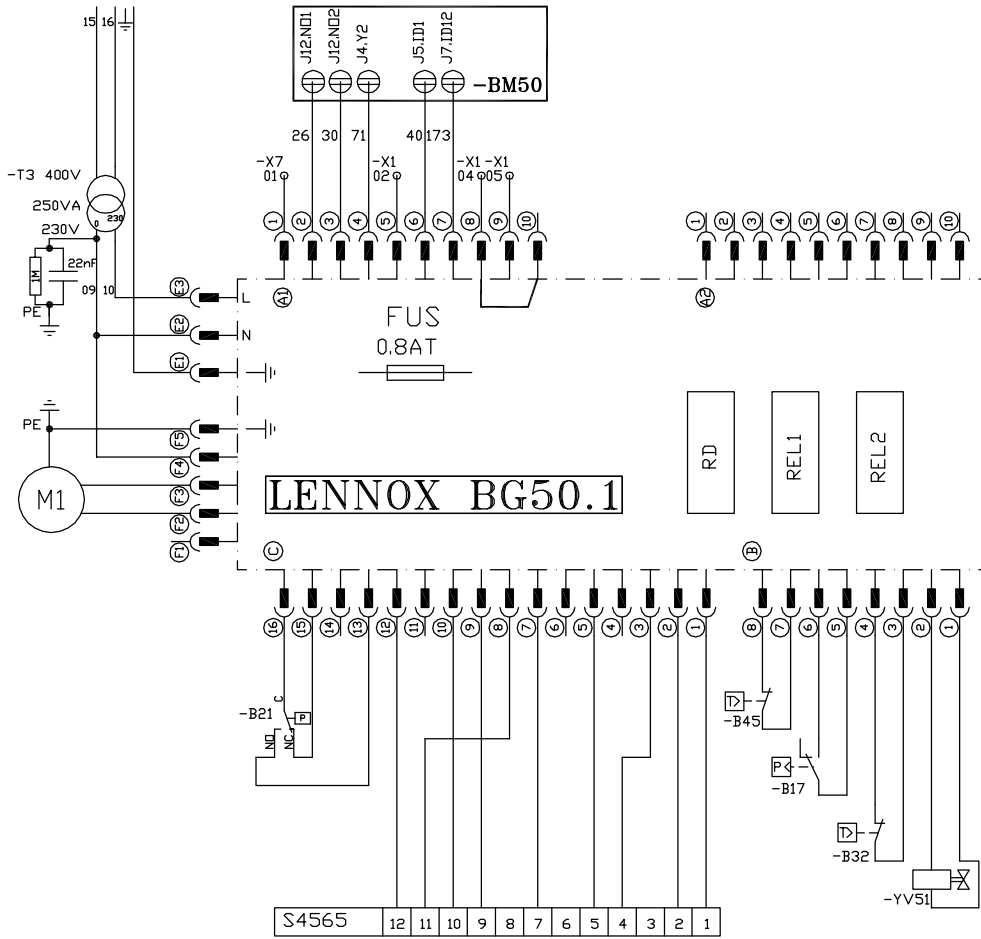

Indice	DATE	NOM	MODIFICATIONS

(2) FGM 120 S  
 Kit chauffage  
 GAS

Dessine: CTO  
 Date: 11.01.07



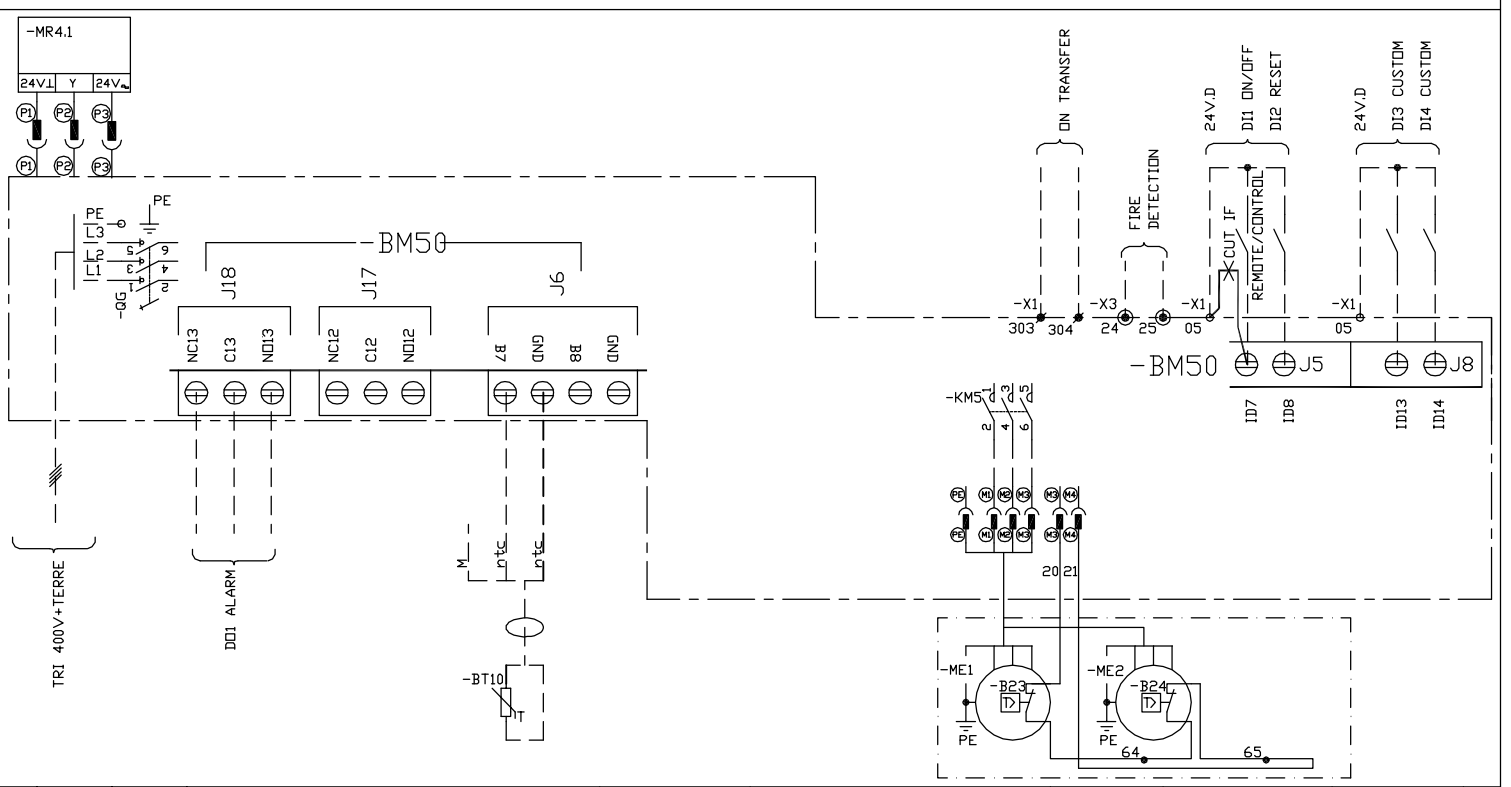
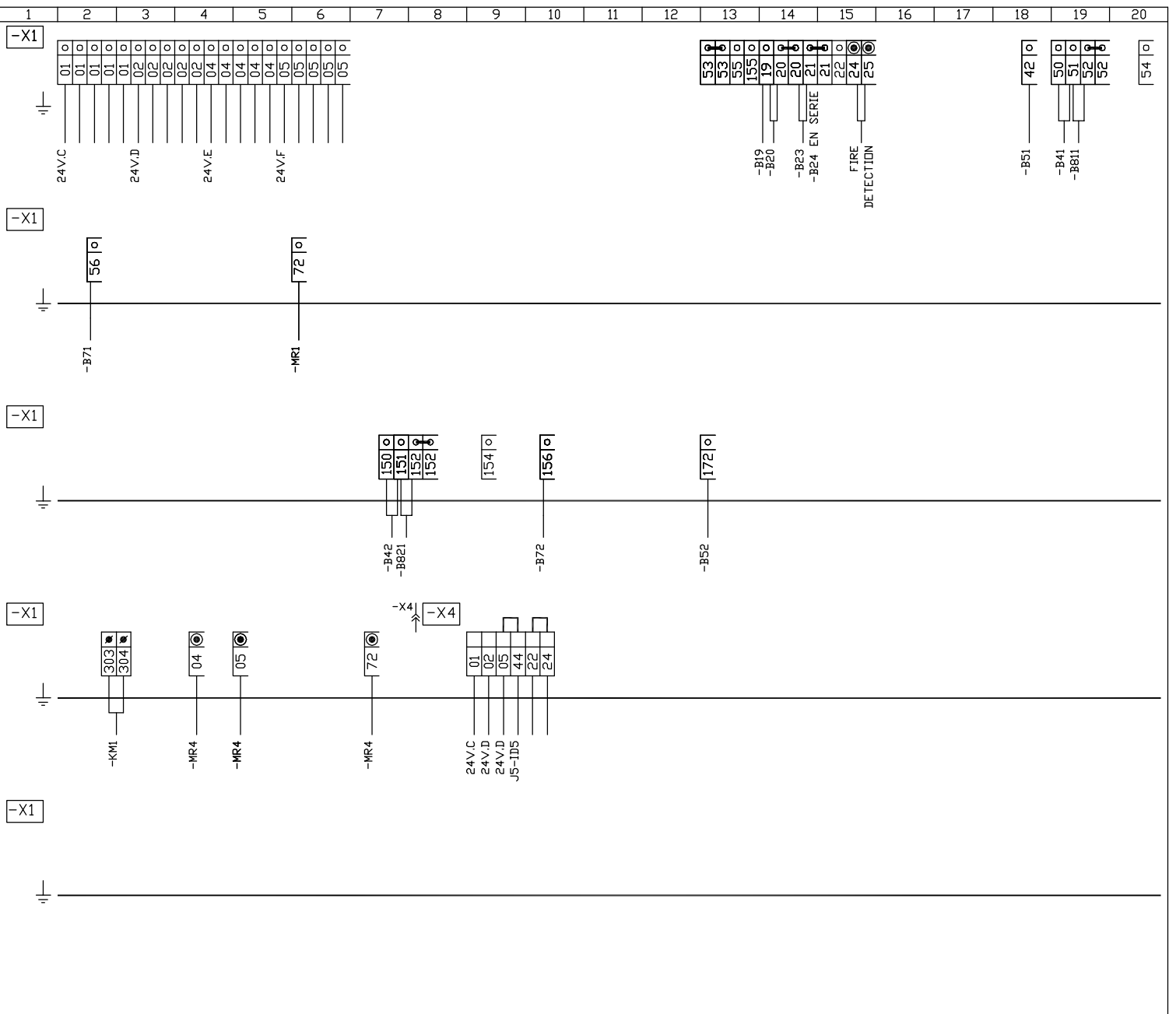





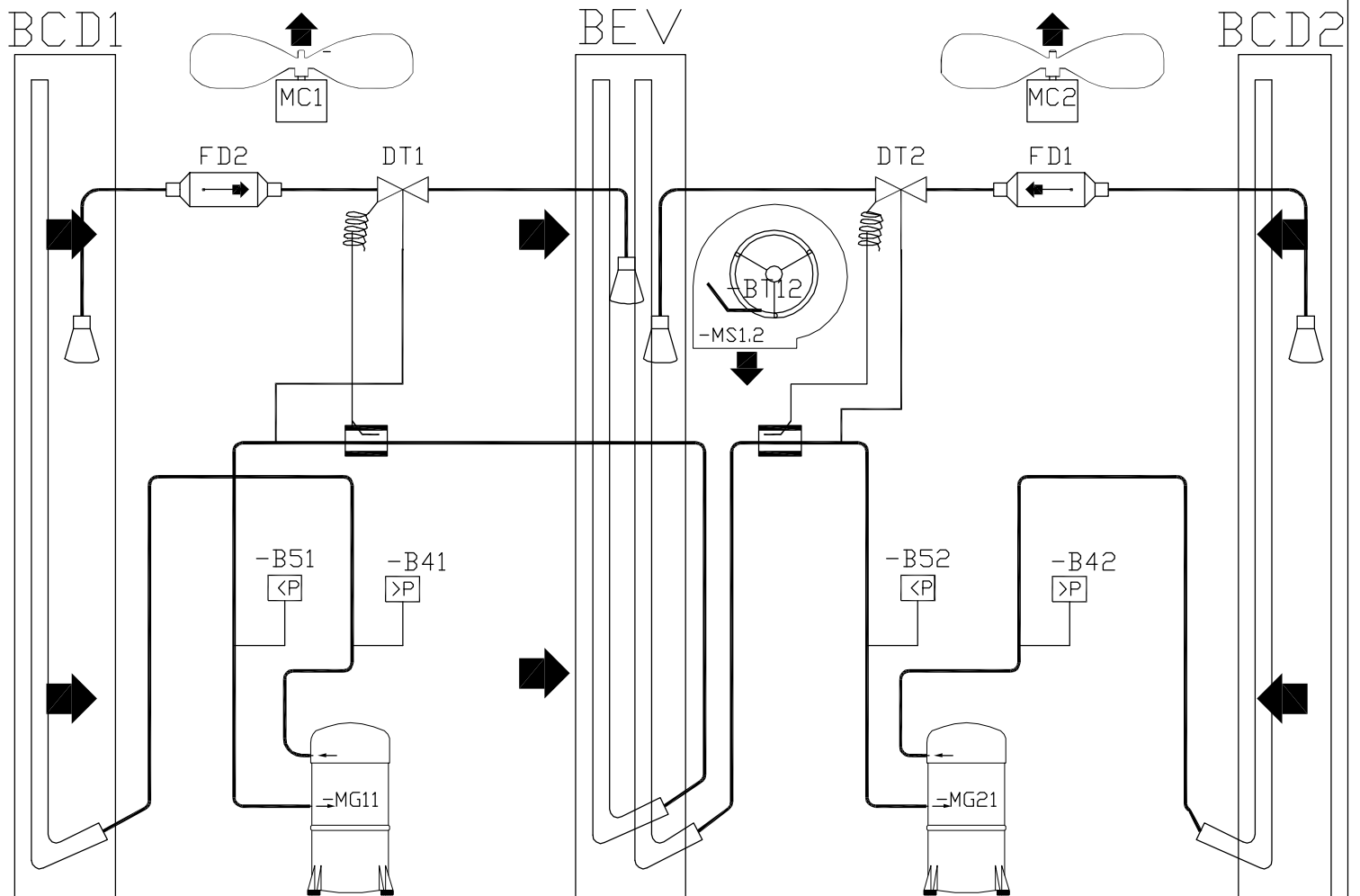

Indice	DATE	NOM	MODIFICATIONS

(2) FGM 120 S  
 Schéma Frigorifique \ Hydraulique  
 Cooling \ Hydraulic Diagram

Dessine: CTO  
 Date: 11.01.07



252686 9/11



