

Indice	DATE	NOM	MODIFICATIONS
			
<i>Co op Store, Louth</i>			
(1) FGM 120 H LENNOX UK	Dessine: CTO Date: 16.06.08	PAGE DE GARDE	261467 0 / 11

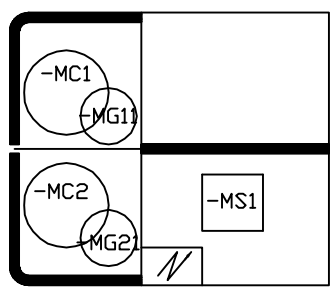

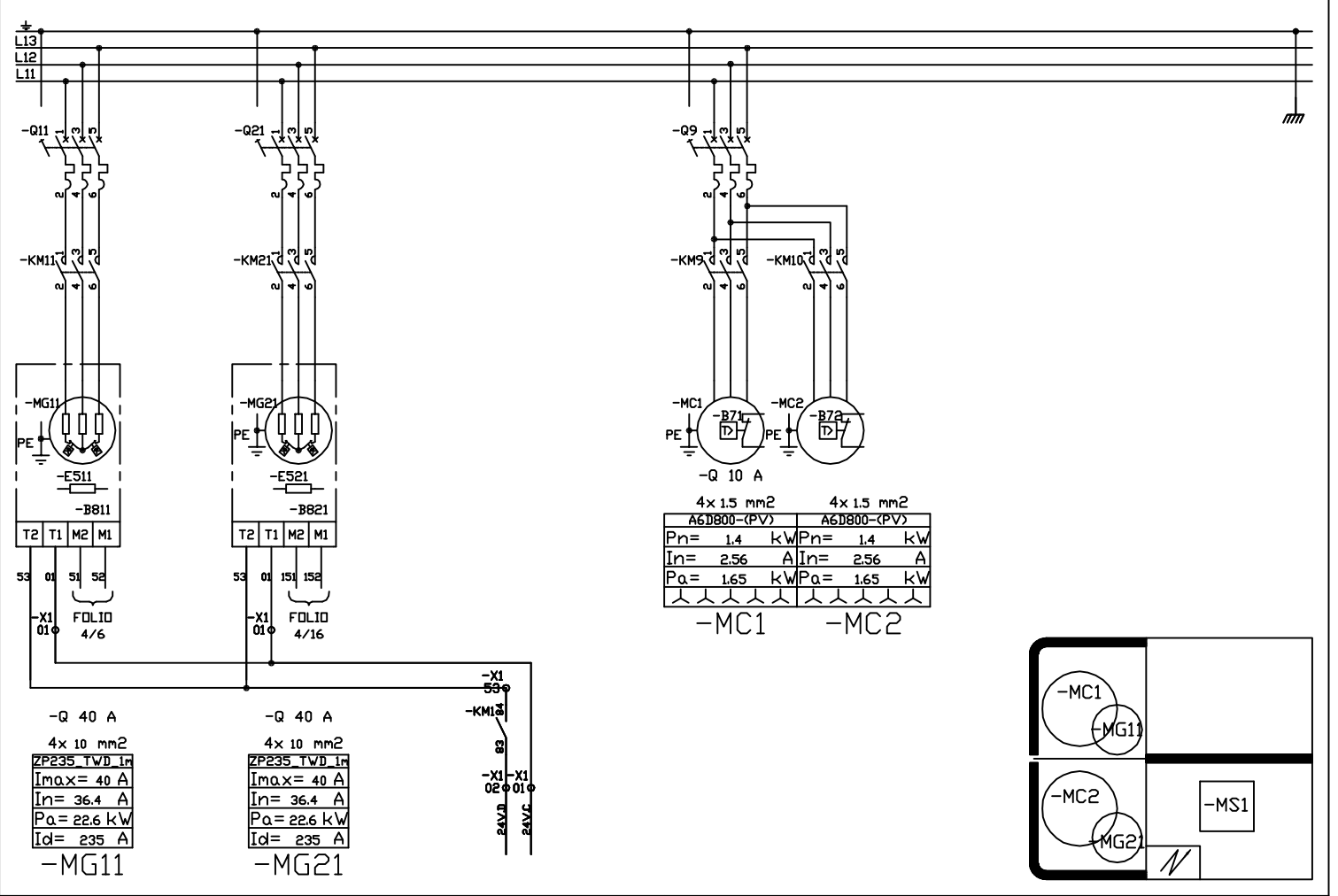
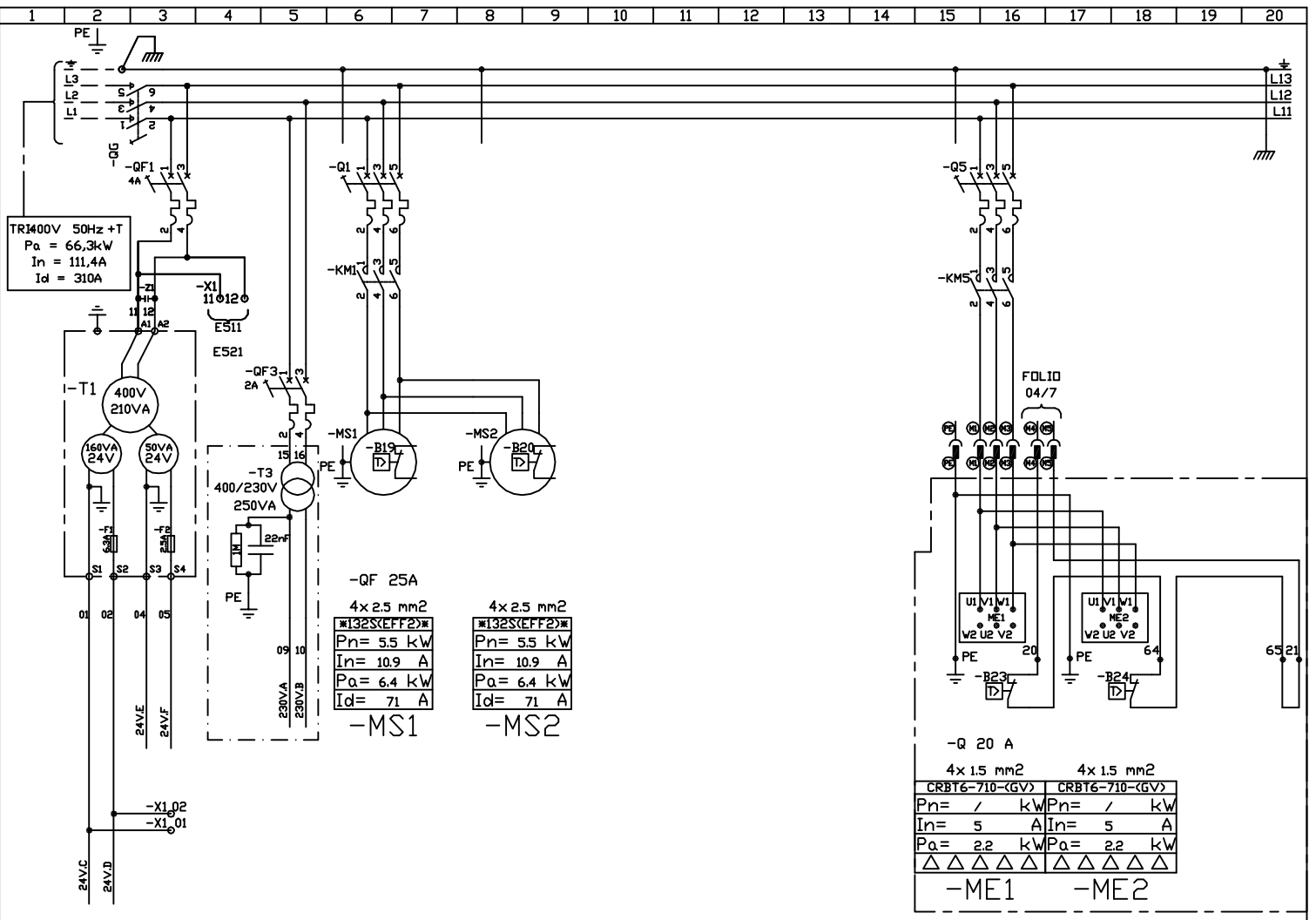
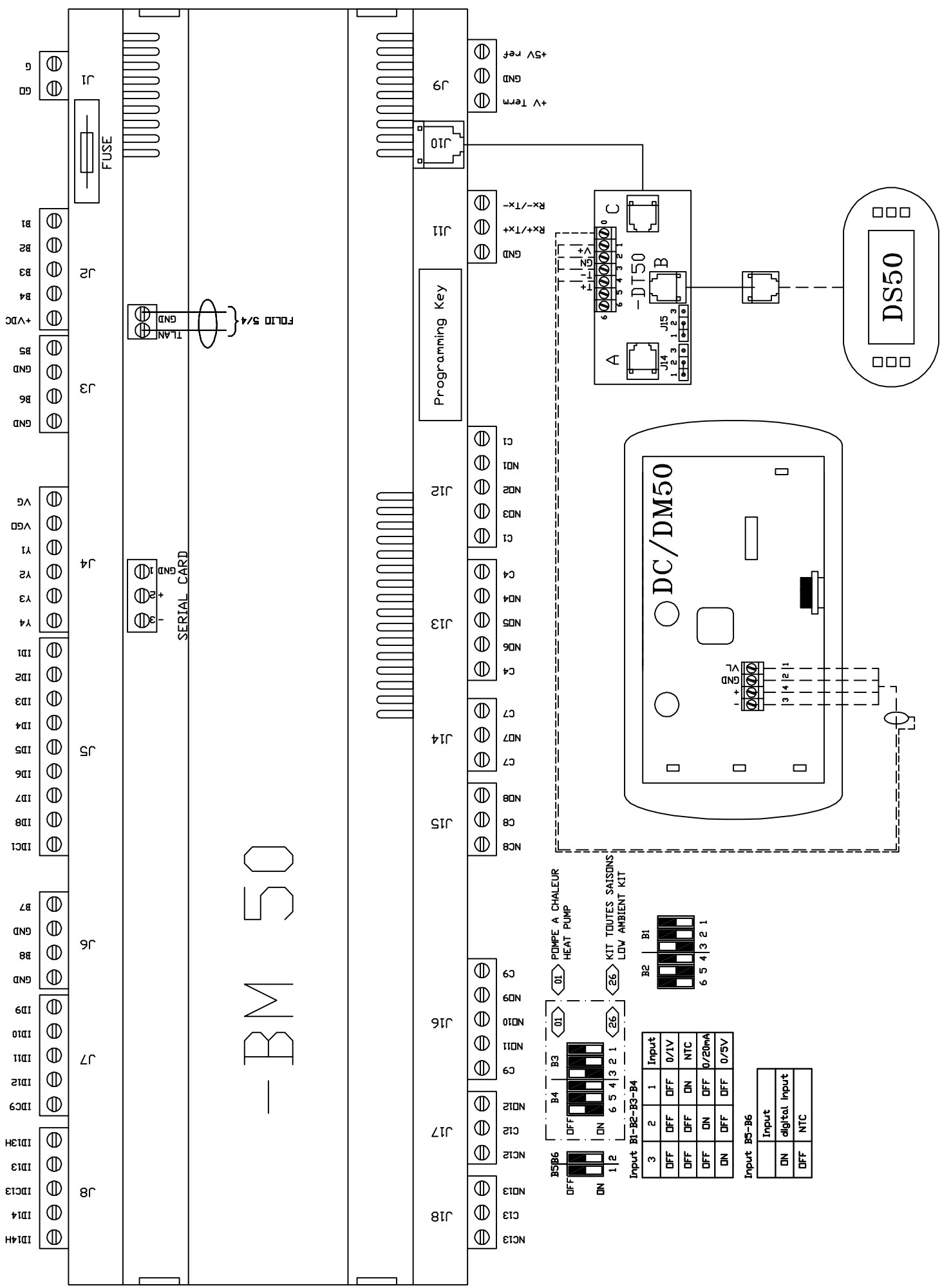

Indice	DATE	NOM	MODIFICATIONS

(1) FGM 120 H
Automate CLIMATIC 50
Climatic 50 Controller

Dessine: CTO
Date: 16.06.08



261467 2/11

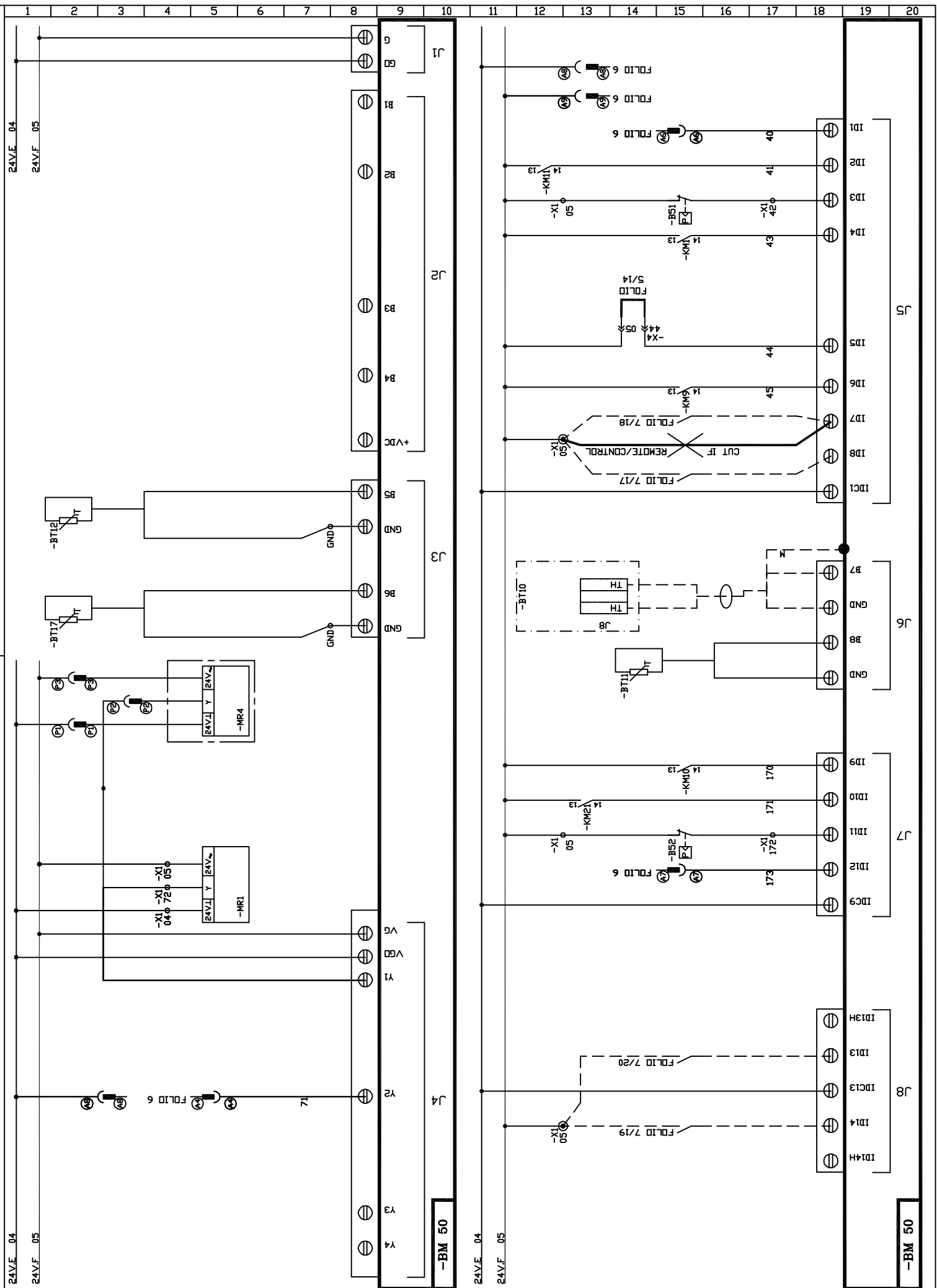

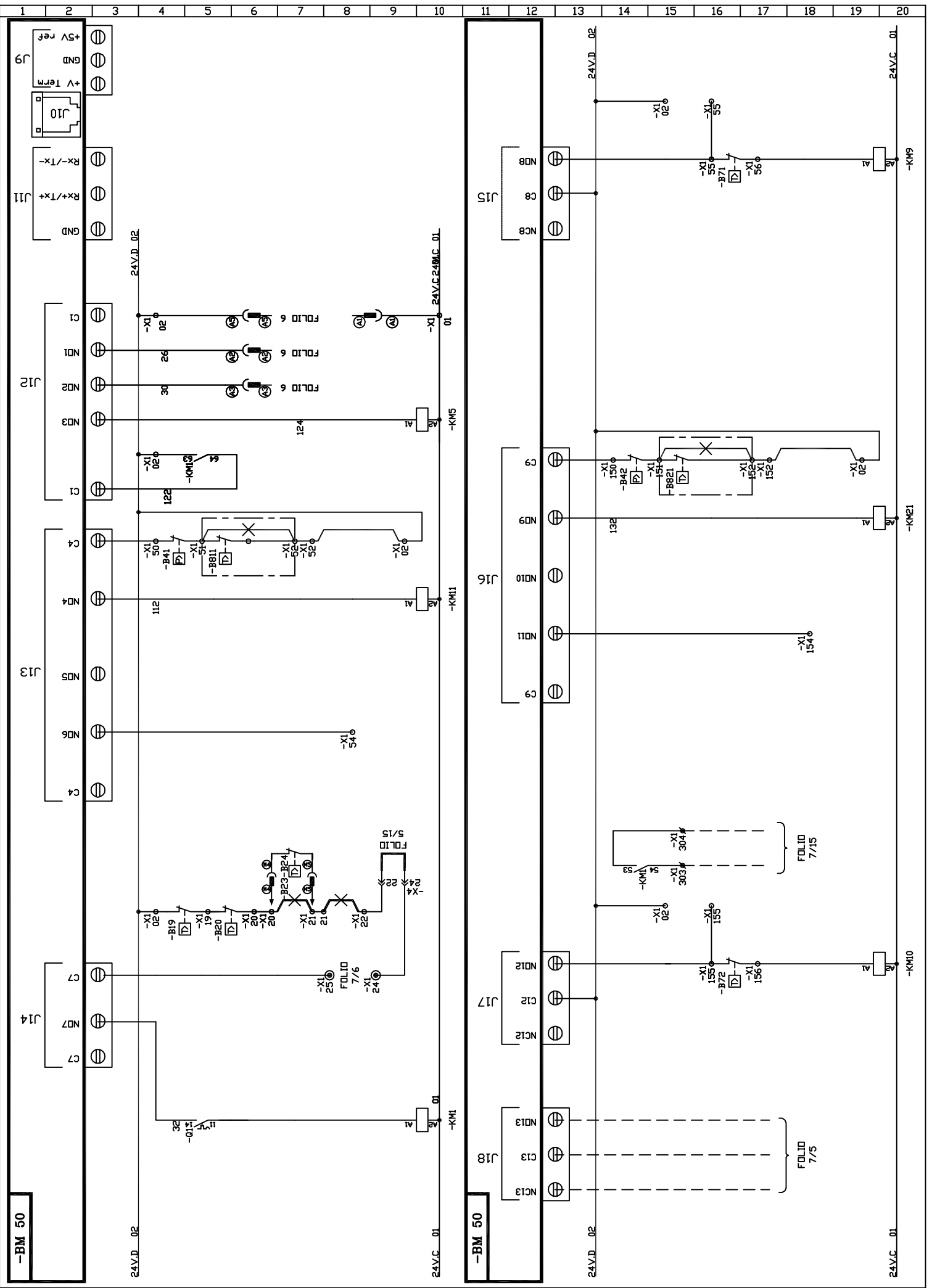

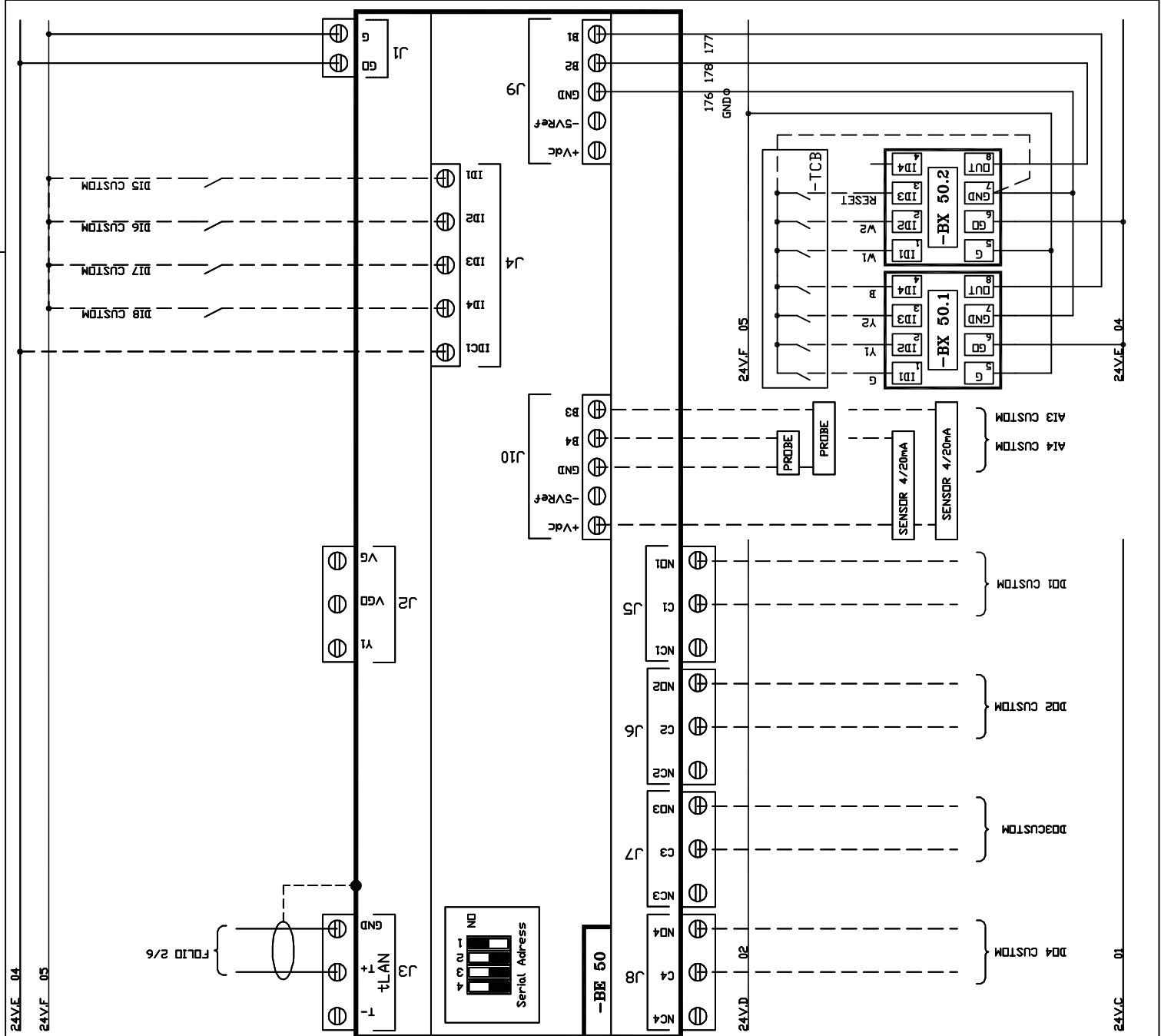
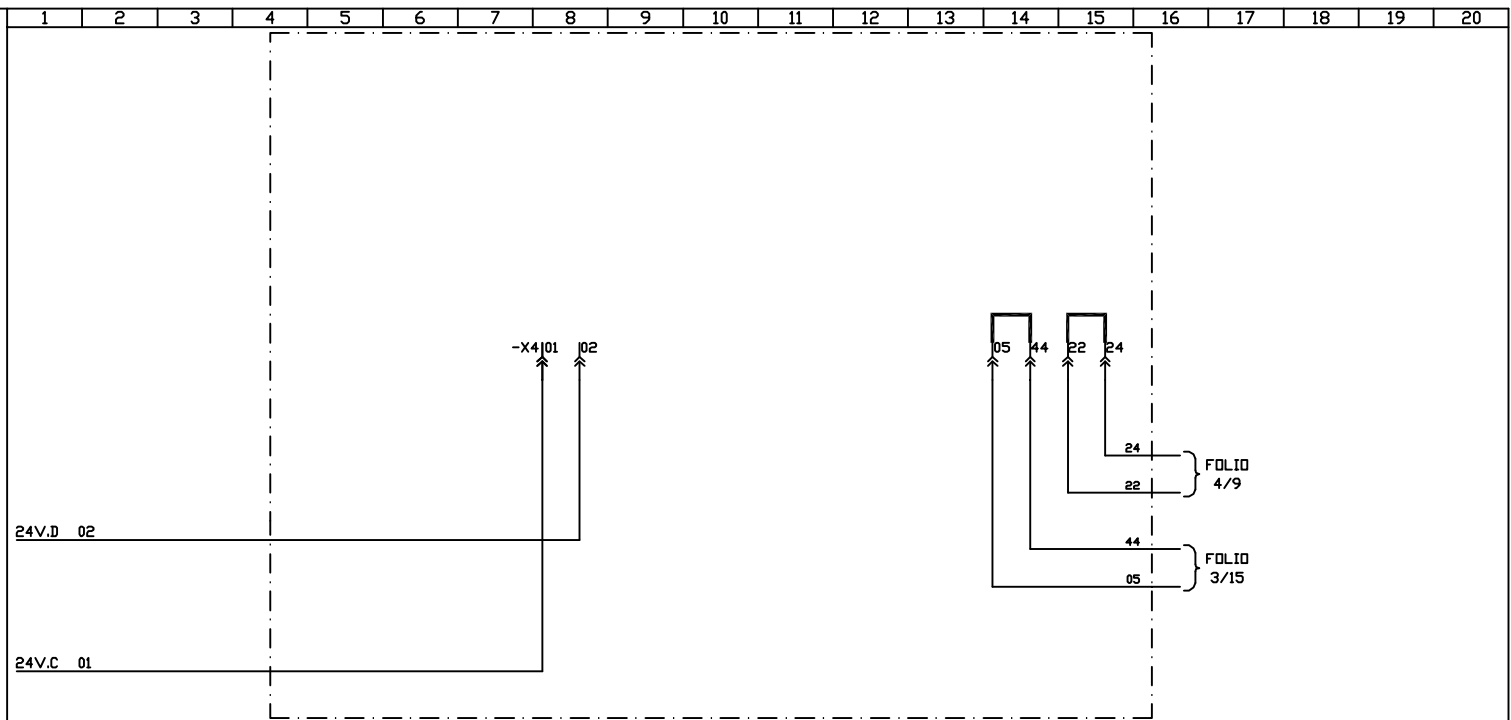

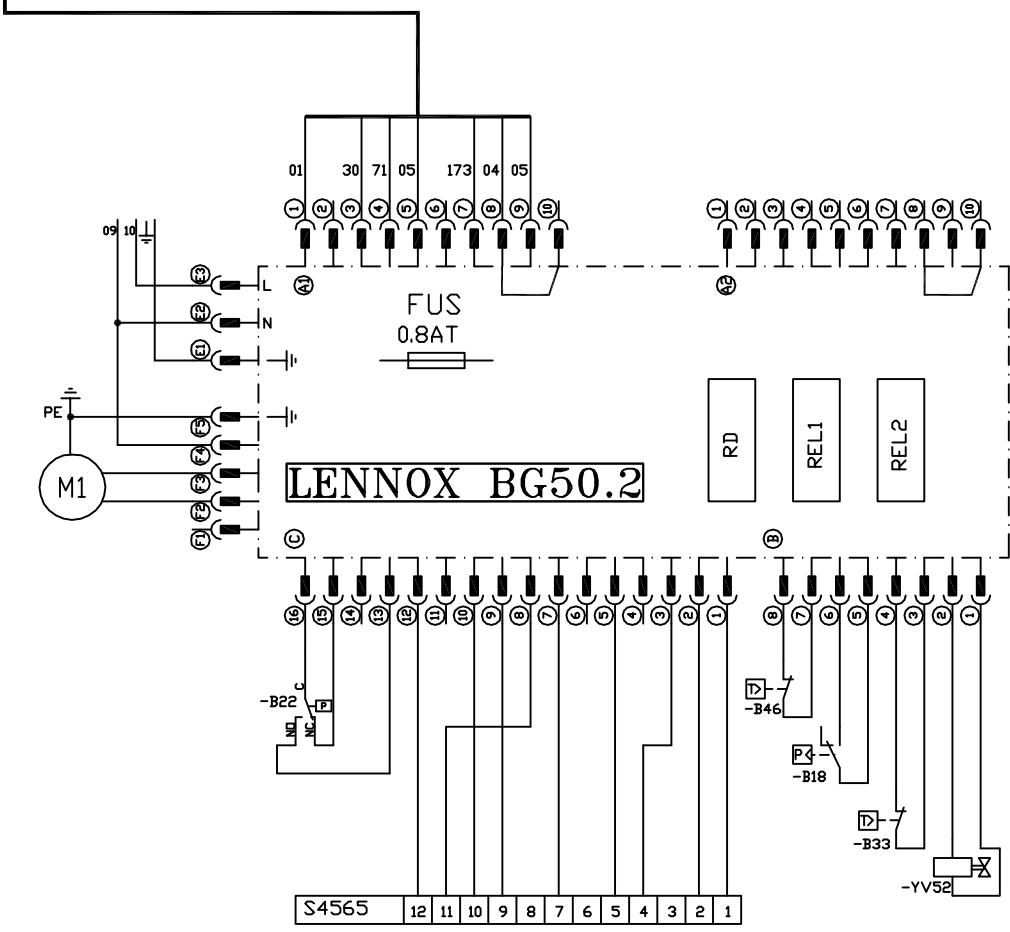
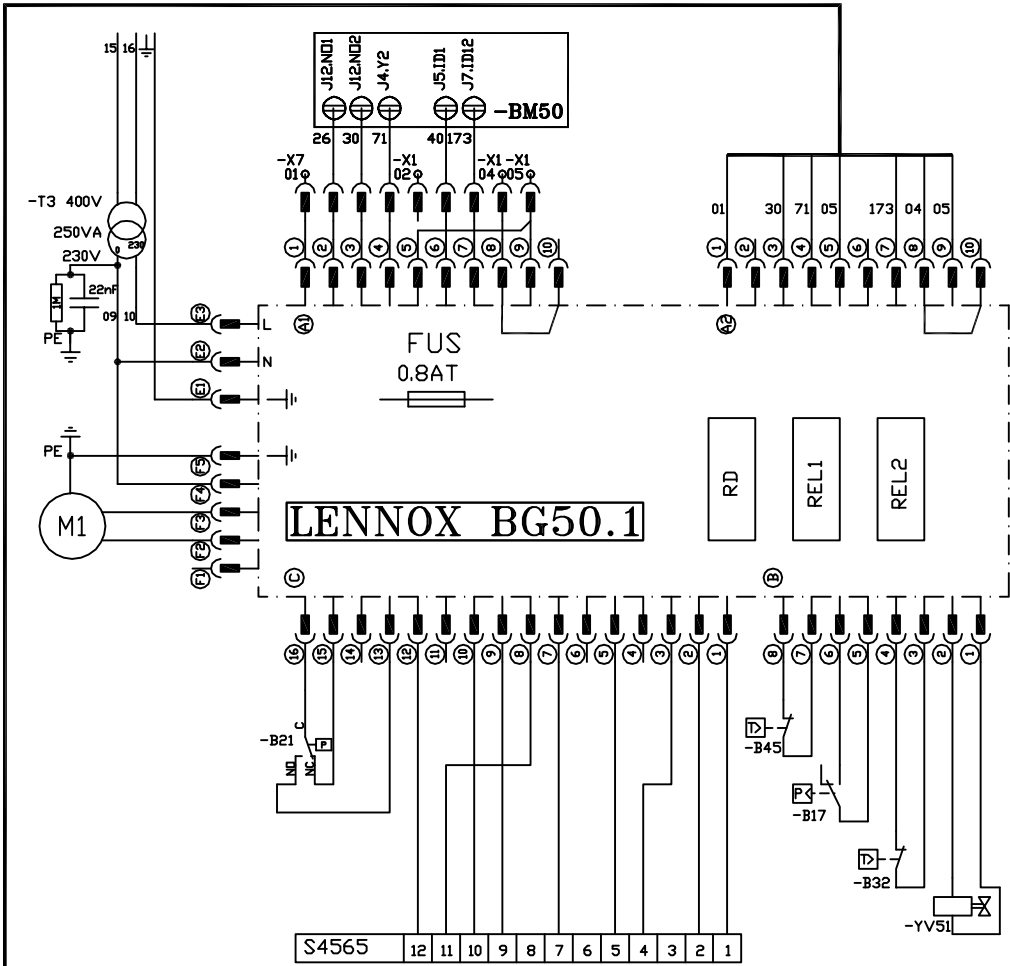

Indice	DATE	NOM	MODIFICATIONS

(1) FGM 120 H
 Kit chauffage
 GAS

Dessine: CTO
 Date: 16.06.08



261467 6/11

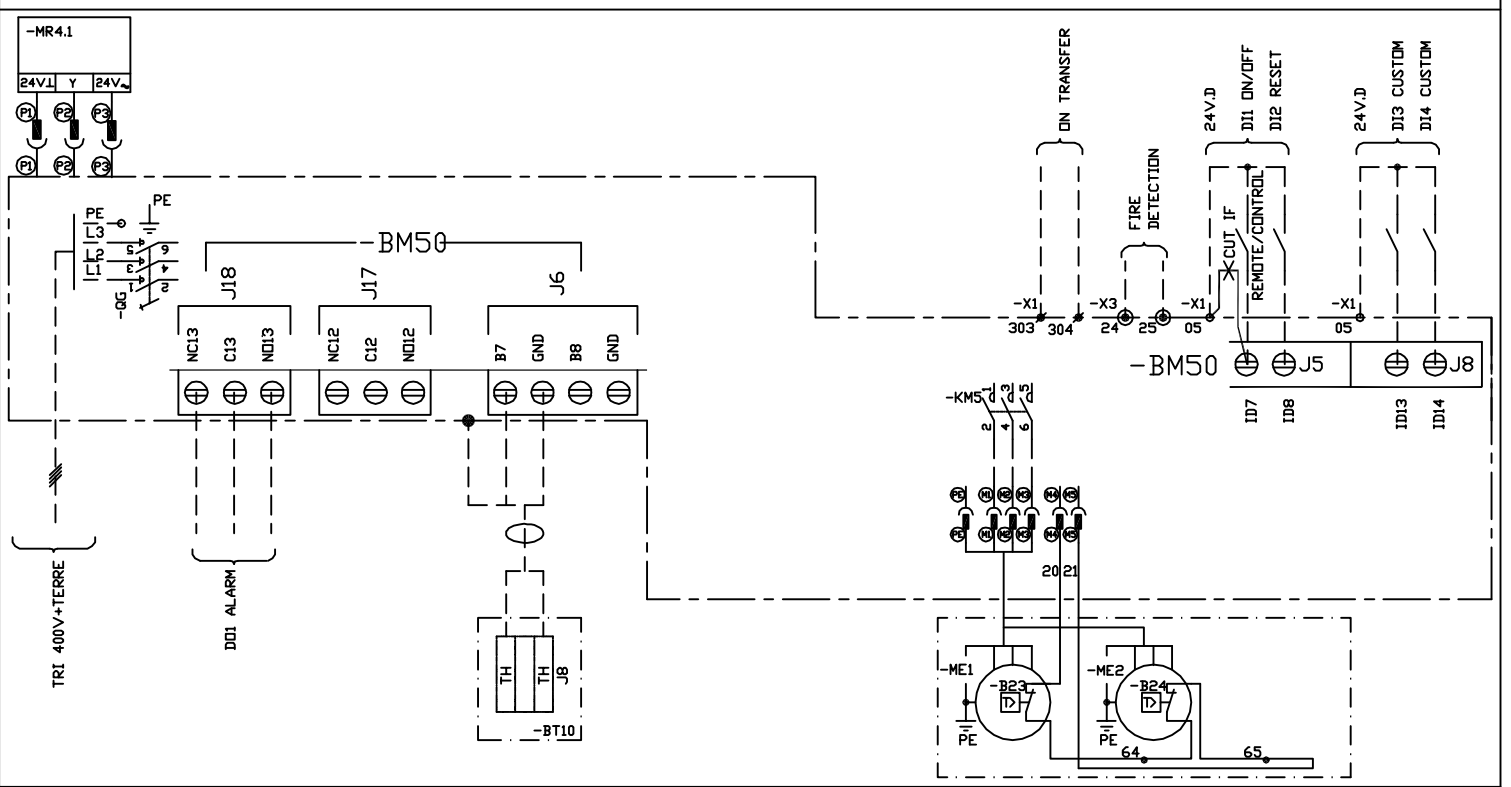
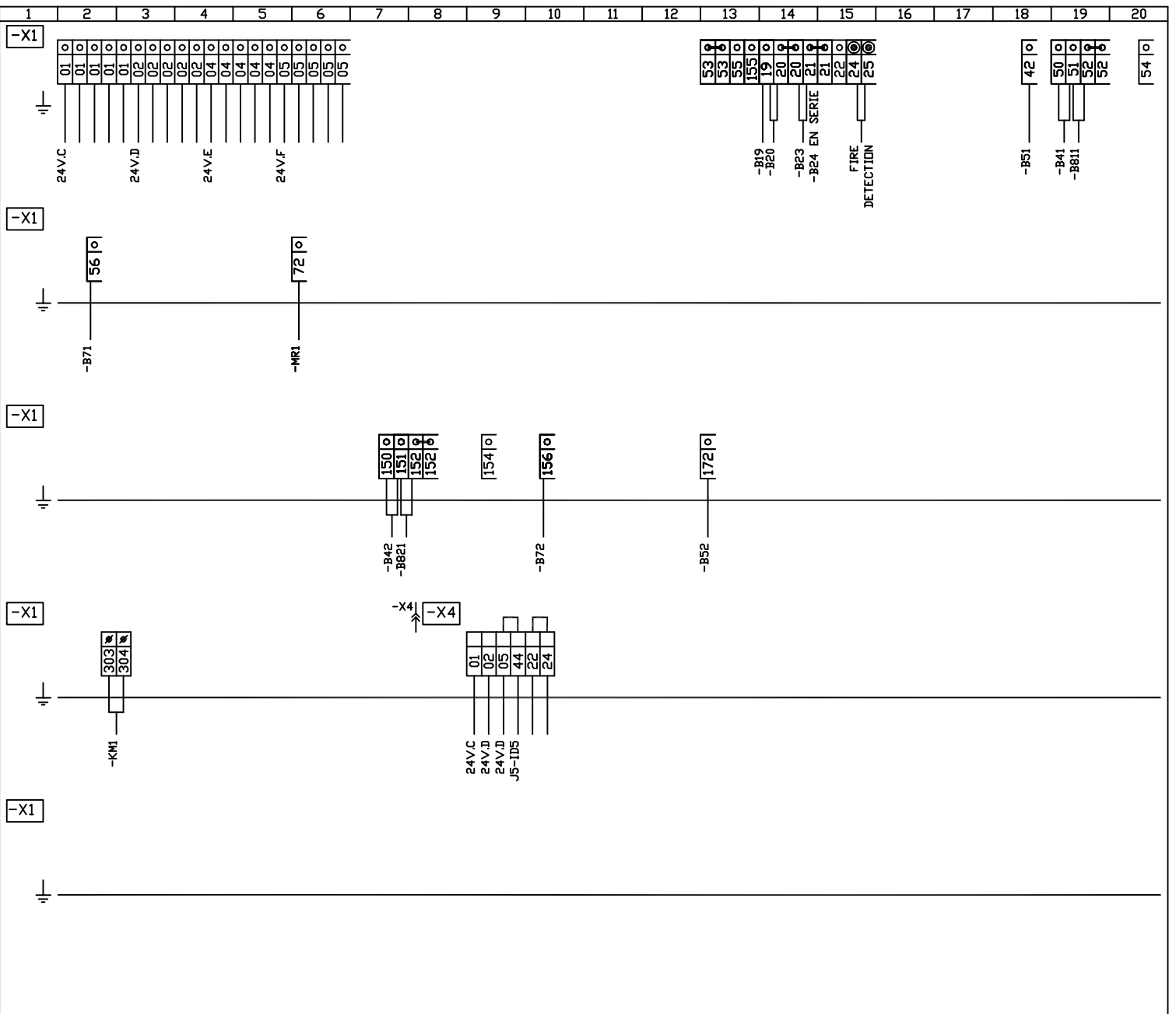

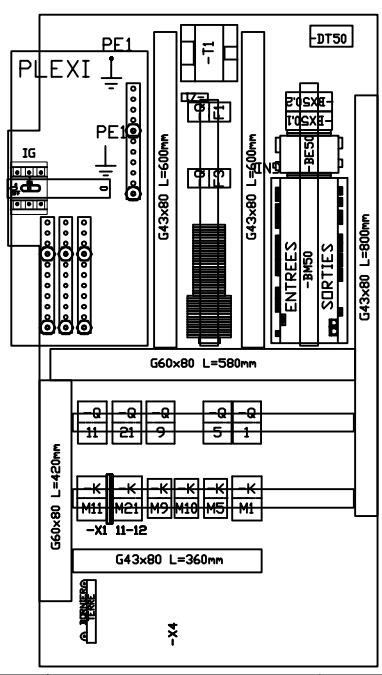

REPERE	REFERENCE	CODE	Nb
-QG	INTER DT 125 E3	4480659H	1
-QG	POIGNEE DE MANOEUVRE DMY2AJ	4480661L	1
-QG	ARBRE DE MANOEUVRE DX330	4480660J	1
PROFIL	OMEGA 35x7.5x1.5 LONG:200mm	5160002P	1
-QG	ISOLATEUR ISD 30 M6 REF:551440	5480311J	2
-QG	PLAT CU 25x5 LONG:220mm	5480307Z	1
-QG	PLAT CU 25x5 LONG:220mm	5480307Z	3
-QG	ISOLATEUR ISD 30 M6 REF:551440	5480311J	6
-QG	Plexi de protection	77570134	1
-Q1	C60N 3P3D 25A D REF:24604	4480498V	1
-Q1	CONTACT AUX. D/F REF:26924	5480156F	1
-KM1	LC1 D25 B7	4410653H	1
-KM1	LA DN40	5410087M	1
-QF3	C60N 2A BIPOL COURBE D	4480474K	1
-QF1	C60N 24583 4A BIPOL COURBE D	4480591H	1
-T1	210VA 400V/24V/24V	4430135H	1
-Z1	LRC V2-0.22-220/400V	4770010X	1

REPERE	REFERENCE	CODE	Nb
-BMS0	CLIMATIC 50	4770607Z	1
-BE50	Extension CLIMATIC 50	4770615M	1
-BX50.1.2	MULTIPLEXEUR TCB	4770616N	2
-DT50	-DT50	4770623Y	1
BORNIER	D2.5/5.SNBT.2L ORANGE	5470163K	2
	PLAQUE DE FERMETURE FED5.2L	5470512X	1
	D2.5/5.2L GRISE	5470200N	**
	PLAQUE DE FERMETURE FED5.2L	5470235P	1
	D2.5/5.4L GRISE 24V.C.D	5470270R	16
	PLAQUE DE FERMETURE FED5.4L	5470273V	1
	LIAISON 4 POLES BJDLS.4	5470275Y	2
-Q11	C60N 40A TRIPOL COURBE D	4480500X	1
-KM11	LC1 D32 B7	4410654J	1
-Q9	C60N 10A TRIPOL COURBE D	4480495P	1
-KM9	LC1 D09 B7	4410650A	1
-Q21	C60N 40A TRIPOL COURBE D	4480500X	1
-KM21	LC1 D32 B7	4410654J	1
-KM10	LC1 D09 B7	4410650A	1

REPERE	REFERENCE	CODE	Nb
BARRETTE	TYPE MG 14979	5470186T	1
-Q5	C60N 3P3D 20A D REF:24603	4480497T	1
-KM5	LC1 D12 B7	4410651E	1

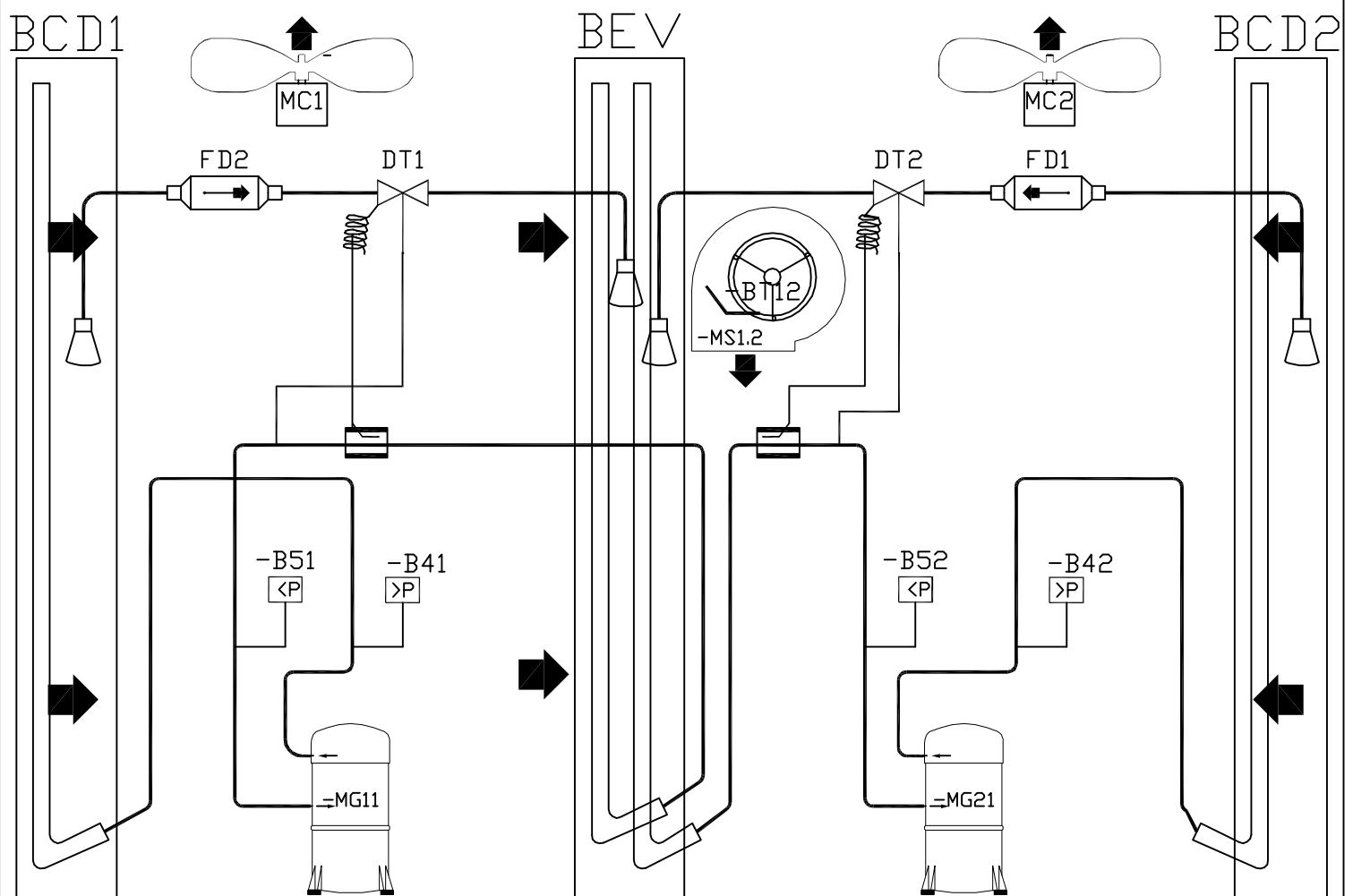

Indice	DATE	NOM	MODIFICATIONS

(1) FGM 120 H
 Schéma Frigorifique \ Hydraulique
 Cooling \ Hydraulic Diagram

Dessine: CTO
 Date: 16.06.08



261467 9/11

