

**LENNOX****DIRECT MULTIZONE SYSTEM—DMS1-275****Heating—Cooling—Ventilating with Multizone Control**

100,000 to 700,000 Btuh Heating—Gas, Electric or Hot Water Options  
 \*93,000 to 281,000 Btuh Cooling—Direct Expansion  
 5,000 to 13,500 Cfm Air Volume—Adjustable Belt Drive Blowers

\*At ARI standard 210 test conditions.

**COMBINATION UNITS**  
**DIRECT MULTIZONE**  
**SYSTEMS**

Page 1

April 1, 1967

- Maximum Flexibility
- All Controls Furnished
- Factory Assembled & Wired
- Beige Aluminum Cabinet
- Many Cooling Options

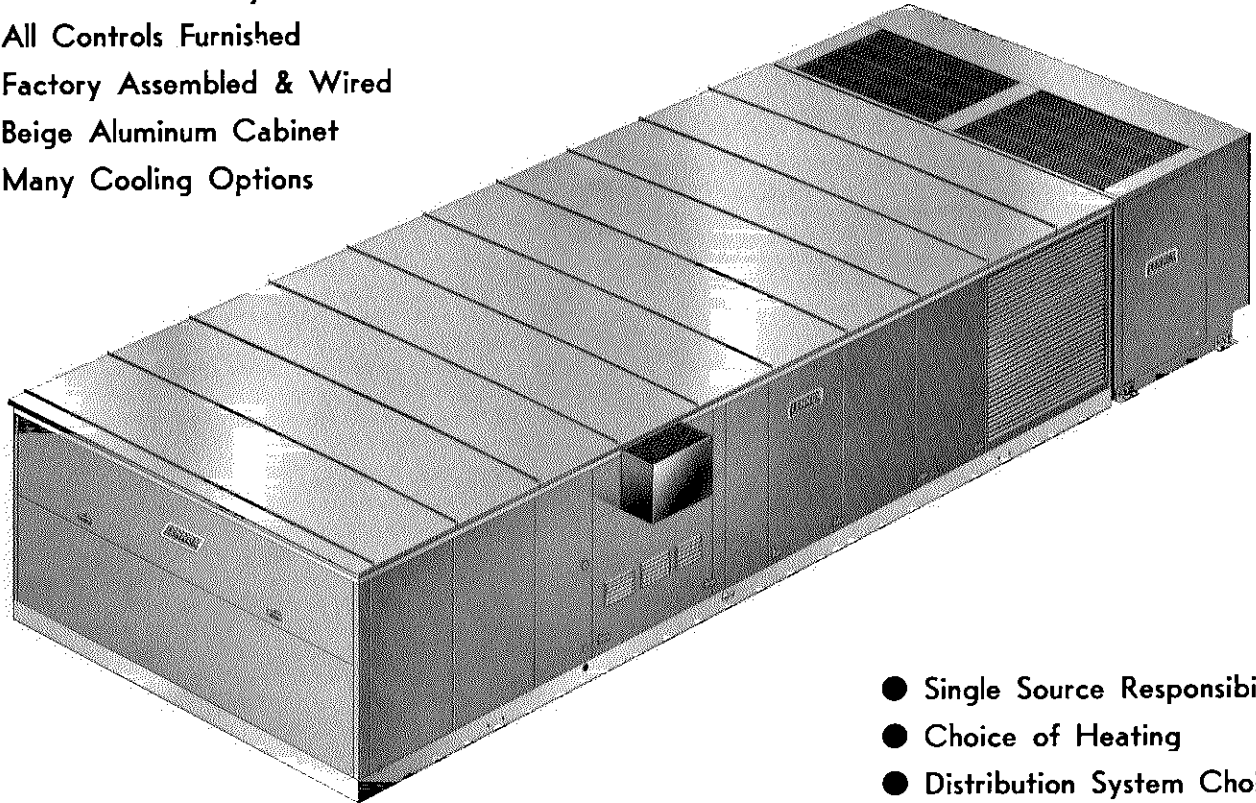

- Single Source Responsibility
- Choice of Heating
- Distribution System Choice
- 100% Weatherproof

### THE NEW CONCEPT IN MULTIZONE COMFORT CONTROL

Heretofore, in commercial buildings requiring multiple zones of simultaneous heating and/or cooling control, engineers have been forced to use hot and chilled water Multizone air handlers, large central station built-up systems consisting of components manufactured by several different companies, and controls for these individual components supplied by yet another manufacturer. Danger of freezing the hot and chilled water coils has eliminated easy methods of utilizing adequate quantities of fresh air for ventilation purposes in cold climates. Further, most central station units have water cooled condensers and in cold climates water towers must be drained to avoid freezing—thus forcing shutdown of the refrigerated cooling system during all of the winter months even though there are extensive periods of time during the winter when refrigerated cooling is needed to maintain proper temperature control in the building. The Lennox Direct Multizone System uses direct-fired heat exchangers in parallel with direct expansion, air cooled refrigeration to provide

precise individual zone control the full year around, simultaneously, in as many separate and individual zones as can be handled with the capacity of the DMS unit. The absence of water in the system eliminates completely the danger of costly freezeups and allows Lennox engineers to make the maximum use of the cooling power available in the outside air to minimize the operating costs involved in cooling the structure.

The Lennox DMS unit is a complete factory assembly of highly engineered, integrated components in a weatherproof, attractive, low silhouette "package" including all necessary controls factory installed, factory tested, and approved by appropriate approval agencies. All internal wiring is completed including a disconnect switch and the necessary wiring harness for the adjacent condensing unit. In addition to the controls factory installed in the DMS unit, Lennox offers two thoroughly tested Zone Control Systems for the Lennox mixing dampers.

### SINGLE SOURCE FOR COMFORT RESPONSIBILITY

Thus, for the first time in the history of commercial Multizone work, it is possible for the engineer to specify and the customer to purchase an entire Multizone Comfort System from one manufacturing source. Never before has it been possible for the customer through his engineer to turn to a single source for quick, efficient and economical servicing of his mechanical equipment. All too often in the past the

customer and the engineer have had to involve themselves in attempting to determine just who, of the many manufacturers contributing parts and pieces to a mechanical system, was responsible for the comfort result. Unfortunately, in most cases no one would accept this responsibility. With DMS, Lennox, and the Lennox-trained installer are and want to be totally responsible for the end comfort result.

### SELECTED OVER COMPETITION

So successful has the Lennox DMS unit's ability to produce accurate year-round control of simultaneous heating and/or cooling in individual zones been that it was selected over industry-wide competition for

exclusive use in 2,400,000 square feet of California school space bid under the auspices of the Ford Foundation sponsored School Construction Systems Development Group in Palo Alto, Calif.

NOTE—Specifications, ratings and dimensions subject to change without notice.

## MAXIMUM FLEXIBILITY IN A COMPLETELY FACTORY-TESTED PACKAGE

The concept of a complete factory assembled, wired, controlled, and tested package by no means limits design flexibility.

**HEATING**—Choices of gas-fired heat exchangers, straight electric heating elements, or hot water coils are available.

**Gas Heating**—New Lennox DURATUBE heat exchangers give top efficiency and handle 100% outdoor air without condensate problems due to self elimination. Tube and drum construction permit normal heat element expansion and contraction without metal fatigue. True power burner principle gives smooth operation regardless of outdoor wind or atmospheric pressure. All heat exchanger surfaces are DURAGLASS coated. Two stage control approximately 50% to 100% is standard. 6,000 volt spark ignition with "electronic" controls. Flame rod flame detection, pre-purge and post-purge is standard. Three capacities available—250,000, 350,000 or 500,000 Btuh maximum input. AGA approval on all sizes. All controls are factory installed, wired and piped. In addition, the unit is factory fire tested.

**Hot Water Heating**—Factory installed hot water coils have either straight three-way modulating valve control or primary-secondary control with a factory installed wired and piped pump to give a possible range of 100,000 to 700,000 Btuh. Continuous pump operation on primary-secondary systems, total control of the three-way valve with a long element discharge controller immediately downstream from the coil and a spring return outdoor air damper motor all add up to positive coil freeze-up protection.

**Electric Heating**—Electric resistance elements are available in 15 kw increments from 45 kw to 105 kw. Electric elements carry U. L. Approval, and are controlled by a modulating sequencer. Elements are available for 240, 480 or 600V, 3 $\phi$  use.

**POWER SAVER TO MINIMIZE COOLING COSTS**—The Standard Lennox control systems factory installed in the DMS unit minimize the operating costs involved in cooling the structure by automatically utilizing fresh outdoor air to do all of the cooling any time the temperature drops below 58°F. Above 58°F., but below 65°F. outdoor air is used to do as much cooling as possible in conjunction with running the refrigeration equipment. Above 65° the refrigeration equipment does all of the cooling. However, a substantial portion of the cooling season in commercial structures exists while outdoor temperatures are below 65°, resulting in a great saving in operating costs (as much as 70% in some cases) over the old-fashioned central station system that ran 100% of the time.

**COOLING**—Air cooled DX system of 8, 11, 15 or 22 nominal tons is available. 15 and 22 ton models only have all of the refrigeration piping and wiring harnesses furnished, field connection is required. Installer must furnish refrigeration piping and wiring for 8 and 11 ton models. Refrigeration connections are mechanical—either rotalock or flare.

**Prepared For Air Conditioning**—The DMS unit may also be ordered less cooling, but prepared for future air conditioning. A perforated

pressure plate is substituted for the direct expansion evaporator and all of the necessary controls, and refrigeration piping will be installed in the DMS unit during its construction. Cooling can then be added at a later date by simple removal of the pressure plate, installation of the direct expansion cooling coil, and connection to the companion condensing unit. Thus, it is possible for a school district, a commercial building, hospital, clinic, etc. to enjoy sophisticated heating and ventilating during initial use and later easily upgrade the system to include cooling for a true year-round comfort system.

**ZONE DAMPERS WHERE DESIRED**—A choice of 8 or 12 zone dampers mounted in the DMS unit is available. These may be used in any combination—for instance one damper motor driving 4 zone mixing dampers feeding one zone. Full capacity of the DMS unit can be handled through as few as 9 of the 12-damper set and as few as 6 of the 8-damper set if so desired. The mixing dampers incorporate an adjustable bypass whereby 0 to 30% of the air can be bypassed through the cold duct side of the unit. Further sophisticated construction and tight sealing reduce leakage to less than 1% through the closed warm air dampers.

For applications where more than 12 zones per DMS unit exist or where it becomes more practical and economical to run dual hot and cold ducts the length of a building, mixing boxes are available for application in or near each zone requiring individual room control. These mixing boxes handle from 150 cfm to a maximum 2200 cfm each. CAUTION: Lennox mixing boxes for dual duct application and mixing dampers mounted in the unit are carefully sized to cooperate with the internal air handling characteristics of the DMS unit and, therefore, for optimum, service-free application, the Lennox DMS unit should not be used with other, job-constructed mixing dampers.

**AIR FILTERING**—Generous filter area consisting of 1 inch, 20 pores per inch Scottfoam in rugged, individual galvanized metal frames with face velocities below 300 ft. per minute in most applications is supplied as standard with the Lennox DMS unit. The upstream face is exposed (not confined by wire fencing) for convenient vacuum cleaning in place utilizing the 120V convenience outlet inside the DMS unit. The multiple metal framed filters are sized for convenient removal if it is desired to clean the filters some place else. Filter media is oiled at the factory for increased efficiency. When reoiling after cleaning use RP products #418 heavy duty filter coating. Further, the high holding capacity and large face area of the DMS filters mean less frequent servicing than is required with filters in other commercial installations. The DMS filter racks are 3" thick providing room for 2" of additional filtering material—such as activated charcoal—down-stream from the standard filters.

**CHOICE OF BLOWER DRIVES**—A wide range of blower motor horsepower and drives for the two 15 x 15 blowers is available to provide a cfm range varying from 5,000 cfm to 10,500 cfm against external static pressures varying from 0 to 1.0" water gauge.

## TYPICAL APPLICATIONS

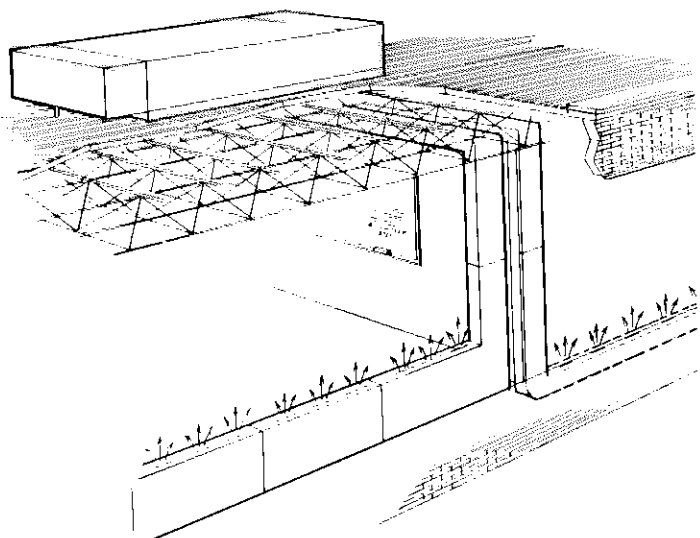

Floor diffusers or Lennox COMFORT CURTAIN duct distribution system.

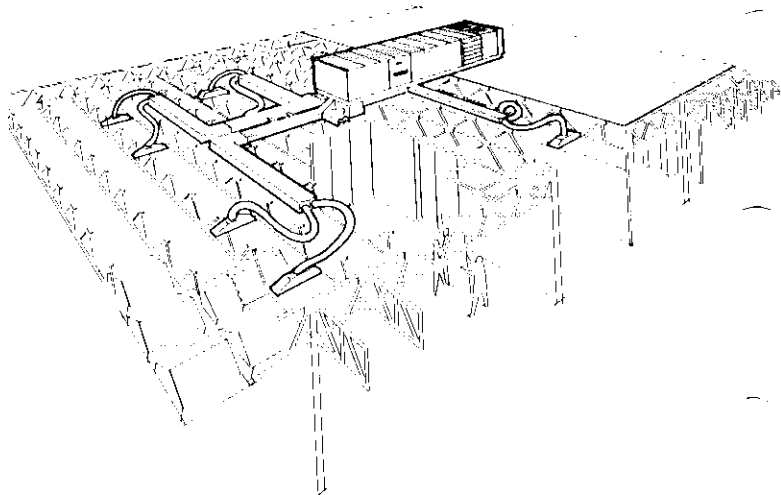

Ceiling distribution system

# DMS1-275 CUTAWAY SHOWING AIR PATTERN

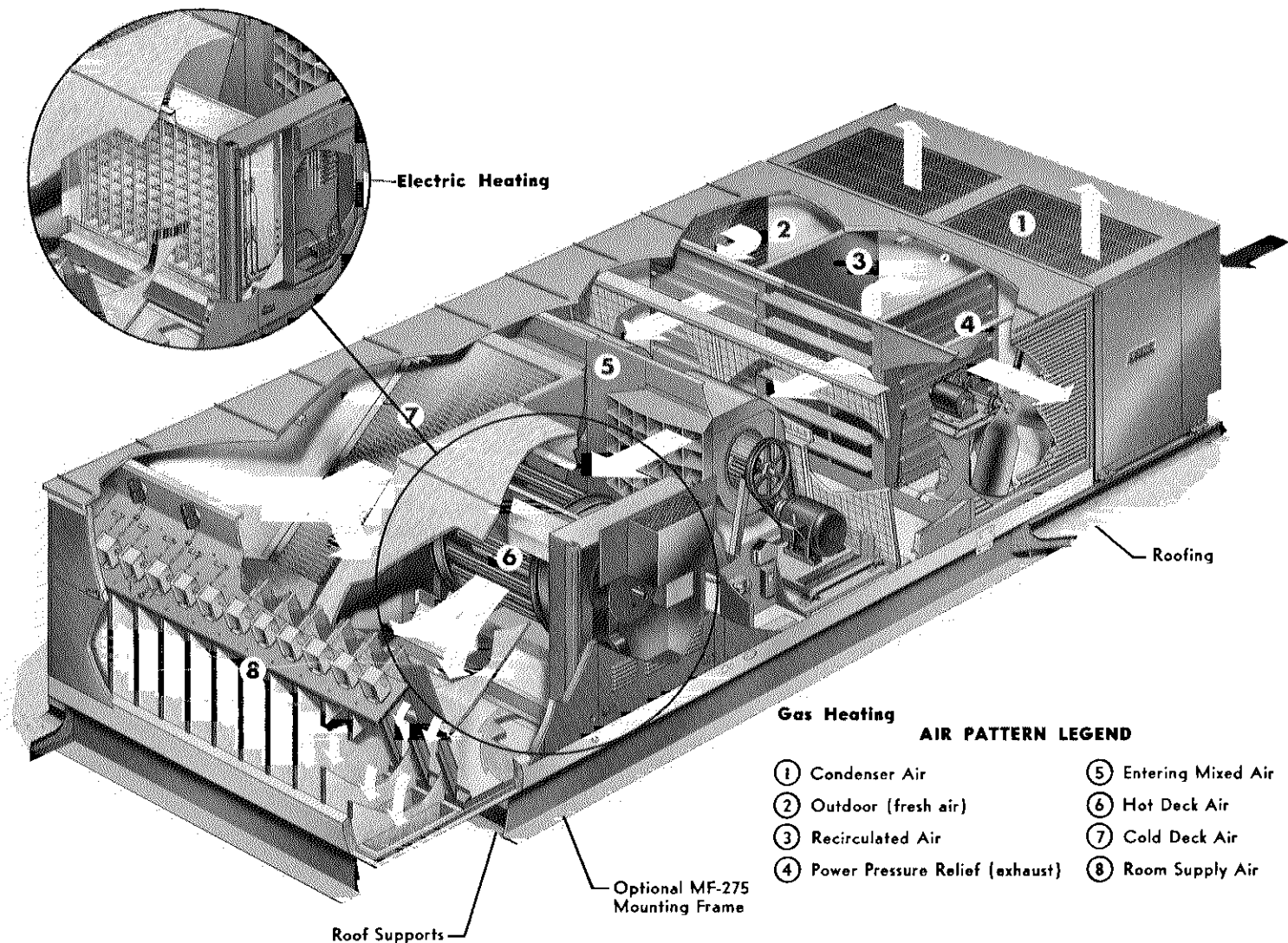

## DETAILED ENGINEERING DESCRIPTION

**FEATHERWEIGHT WEATHERPROOF CABINET**—Although designed for installation anywhere outdoors, the 42" high, low silhouette, light weight aluminum construction of the DMS unit makes it ideal for rooftop application with a roof loading factor in its heaviest configuration of less than 25 lbs. per square foot. Rugged highly specialized aluminum extrusions used for the base frame, transverse members, filter rack, etc. are MIG welded into an extremely rugged basic structure. The "roof" and sides of the structure are aluminum panels carefully formed and assembled with standing seams, built in flashing and counter-flashing to provide complete weather sealing. These aluminum side panels are mill finished with an accurately roller coated, high-grade, baked enamel beige finish of the highest quality commercially available today. The result is a most durable outside material which is capable of withstanding any kind of outdoor atmosphere.

The aluminum roof of the DMS is bowed slightly to prevent water puddling and the welded extruded aluminum structure provides strength enough to carry a load equivalent to 8.2 ft. of snow at 20°F.

**NONHYGROSCOPIC POLYURETHANE INSULATION**—All of the aluminum side panels are insulated with 1 inch foamed in place, Freon filled, foil lined polyurethane foam which gives an over-all "U" factor of .10 Btuh per sq. ft. per 1° TD. This foam aluminum sandwich gives a complete vapor barrier against moisture either on the inside or outside of the unit. In addition it very effectively "deadens" all panels contributing substantially to the extreme quietness of the unit. The urethane foam insulation on the bottom is sandwiched between two layers of aluminum sheet and shaped to provide auxiliary drain pans for the evaporator and so that snow or water pulled in the fresh air opening will drain away. The aluminum foam sandwich is 1½" thick.

**MINIMUM INSTALLATION LABOR**—Installation labor has been reduced to a minimum. An optional steel roof mounting frame which exactly fits the perimeter of the DMS unit is available. This can be

easily flashed into the roof before the DMS equipment arrives on the job. The base frame extrusion on the DMS unit incorporates a neoprene sponge gasket which, when the DMS unit is set on the optional roof mounting frame, provides a weather seal in addition to resilient isolation. No extra labor required for flashing. Supply and return air openings are out the bottom of the DMS unit inside the weather sealed mounting frame, and, consequently, no costly flashing of multiple duct openings through the roof is necessary. Control wiring in the field is limited to running low voltage wires from the zone thermostats to the zone mixing dampers. In some cases it may be necessary to mount the zone damper motors in pre-punched, factory located holes in the mixing damper section of the DMS unit, but the only necessary field control wiring is 3 wire, 24 volt. Blower motor and starter furnished. The electrician must pull 120V and 3 $\phi$  power to factory-supplied disconnect switches in the DMS unit, and make electrical connections to condensing unit. The unit must, of course, have gas piping or hot water piping run to the heating section.

**TOTAL SERVICEABILITY**—Total serviceability has been one of the important design criteria for the DMS unit. All exterior panels which must be removed during normal servicing (filter cleaning, for instance) are easily removable with rugged Lennox quarter-turn access handles. A 120V convenience outlet is located inside the unit next to the filter rack to allow the filters to be vacuumed in place. A control center is conveniently located on the side of the unit for all electrical makeup work, overload resetting or system shutdown which might be required.

**FOUR FACTORY-SUPPLIED INTEGRATED CONTROL SYSTEMS**—The standard factory assembled DMS unit includes three separate, but carefully integrated control systems—the Hot Deck Control System, the Cold Deck Control System and the Inlet Return Air-Fresh Air Control System. Due to varying building and zone requirements the Zone Control Systems must be ordered separately.

**THE INLET FRESH AIR, RETURN AIR CONTROL SYSTEM**

The inlet end of the DMS unit has three separate sets of fresh air, return air, and exhaust dampers mechanically interconnected and actuated by an electric Honeywell series 90 modulating damper motor. The damper motor is commanded by an air temperature controller set to maintain 58°F mixed air temperature downstream from the blowers whenever the outdoor temperature is 58°F. As the outdoor temperature rises toward 58°F, the fresh air dampers modulate open and the return dampers close. When the fresh air dampers open to the 30% position, the exhaust dampers start to open and the Power Pressure Relief fan starts to exhaust return air from the building. The exact position at which the exhaust dampers open and the Power Pressure Relief fan starts is field adjustable and should be set to maintain a slight positive pressure in the building.

When the outdoor temperature is between 60° and 65° the control system introduces 100% fresh air into the system. At temperatures above 65° the temperature controller returns the modulating damper motor to the minimum air position required for proper ventilation (this position is adjustable in the field).

**HEATING CONTROLS**—The function of these controls is to have warm air available on the warm side of the system whenever needed and at a temperature appropriate for the outside weather conditions. This is accomplished with an adjustable outside reset ductstat which has a 120 inch long capillary sensing element. The element is serpentine across the warm duct section downstream from the heating element and senses the average air temperature within the warm duct. The adjustable ductstat is factory set to control a warm duct temperature of 80F when the outdoor air temperature is 70F. At an outdoor air temperature of 30F, it controls the warm duct temperature at 113F and at 0 degrees F outdoor air temperature, it controls a warm duct temperature of 136F. If the outdoor air temperature rises to 80F, the ductstat resets to 75F and if the outdoor temperature continues to rise, the ductstat will of course shut off the heat source. Morning warm-up and day-nite control clock timer is available.

**GAS HEAT CONTROL**—For gas direct-fired heat exchangers this ductstat is 2-stage with the stages about 3° apart. The heater will cycle on and off the 50% low stage fire very frequently until this 50% rate is not enough to maintain the average warm air temperature called for. At this point the second, 100% high fire rate begins to cycle. The net effect is to produce modulation in warm air temperature without the problems involved in modulating a gas fired heat exchanger. When gas fired heat exchangers are modulated much below the 50% rate, excessive condensation sometimes develops inside the heat exchanger. Other type heat exchangers have a problem, especially in freezing temperatures, in draining away this condensation. The Lennox GX2 heat section eliminates condensate, therefore no drainage problem.

**HOT WATER CONTROL**—For hot water heat, the ductstat is of the modulating type commanding a Series 90 Honeywell modulating 3-way water valve regardless of whether straight valve control or primary-secondary pumping control is used.

**ELECTRIC HEAT CONTROL**—For electric heat the same modulating reset ductstat used for hot water commands a Series 90 Honeywell modulating sequencer to bring on just the number of electric stages required to maintain the average warm air temperature called for. Some of the electric heat sections are locked out at outdoor air temperatures higher than the adjustable setting (usually 58F) on the compressor monitor. This prevents the entire cooling and heating load coming on the line at the same time.

**COOLING CONTROL**—The Lennox control system is carefully engineered to provide accurate control for the direct expansion evaporator and its air cooled condensing unit operating in ambient varying from 58° to well above 115°F and with air volumes varying from a minimum of 30% of the total air to a maximum of 100% of the total air circulated by the system.

The Lennox condensing units used with DMS are designed specifically for that use and use two L2 series Lennox compressors in separate refrigeration circuits. The high stage compressor cycles on and off but is protected against too frequent cycling with the exclusive Lennox timed off cycle control. 8 & 11 ton units have single compressor.

Refrigeration suction pressure in the low stage refrigeration circuit is the major influence in commanding compressor activity. The high stage compressor cycles on and off under timed off cycle protection to maintain suction pressure no lower than 35°. In the case of the single compressor condensing unit it cycles on and off to maintain a suction temperature no lower than 35°. If there is so little air or so little load on the evaporator that even the low stage compressor will cause suction temperature to drop below 35°, a modulating valve will begin to open, sending discharge gas into the distributor downstream

from the expansion valve to thoroughly modulate refrigeration capacity to exactly fit the needs of the system. In addition, an adjustable outside reset ductstat with a 240 inch long element senses cold duct air temperature upstream from the cooling coil, outdoor air temperature and controls the mixing dampers. It is factory set at 58F and keeps a cold duct air temperature appropriate to the cooling demand by diluting cold outdoor air with room return air. Below 58F (adjustable) the cooling system is deactivated by a compressor monitor which shuts off the condensing unit. The entire cooling load is then handled by the outdoor air. The ductstat will control the cold duct air temperature appropriate to the outdoor air temperature. At 58F outdoor air temperature, it keeps the cold duct air temperature at 58F using 100% outdoor air. At other outdoor air temperatures, the cold duct air temperature will increase 1 degree F for every 10F drop in outdoor air temperature. Example: At 48F outdoor air temperature, the cold duct temperature is 59F, at 18F outdoor temperature the cold duct air temperature is 62F. This is accomplished by precise control of the outdoor air and recirculated air mixing dampers.

**ANY CONTROL CHOICE?**—Fully 90% of the total control function complexity is covered by the factory installed, wired, and tested inlet, Heating, and Cooling Control Systems. The full complement of factory installed heating, cooling, and ventilating controls are accurately described in the A.G.A. and/or U. L. Approvals covering the DMS unit and hence Lennox cannot offer any change, substitution, or modification of its control systems without voiding the appropriate approval.

**ZONE TEMPERATURE CONTROLS**—This fourth DMS control system, the Zone Control System, is not electrically interconnected with the unit, and is the only control system which requires any field wiring. The DMS unit and its three integrated control systems continuously provide to the zone mixing dampers a supply of warm air and cool air at levels automatically modulated in accordance with outdoor ambient and internal loads. The zone control system then has the simple task of mixing these two air supplies to provide a constant volume of air with temperature adjusted for the particular zone.

**STANDARD ZONE CONTROL SYSTEM**—The standard Lennox Zone Control System consists of a special Honeywell 2-mercury bulb, wall mounted thermostat and a Lennox 3-position, 24V damper motor which produces 3-stage operation—full heating, 50-50 mix of warm and cold air, or full cooling. The Lennox damper motor is an extremely rugged 3-position, spring return highly durable motor with the entire gear train and motor submerged in nontemperature sensitive oil sealed in the die cast case. It provides simple, understandable and almost completely noiseless operation. Internal switches enable slaving of a second damper motor with one thermostat, with a third motor slaved to the second, etc. Of the Zone Control Systems tested in the Lennox Laboratory, this combination of thermostat and damper motor gave the most accurate and constant control of zone temperature and accommodated itself to changes in loads quicker than any other type.

**OPTIONAL ZONE CONTROL SYSTEM**—For those who insist on modulating zone controls, Lennox has available a Honeywell Series 90 modulating damper motor with the appropriate "slide wire" type of wall mount thermostat to actuate it. This type of thermostat and its modulating motor gives reasonably accurate temperature control but does not follow rapid changes in load, which can occur in almost all commercial buildings, as well as the standard Lennox control system.

**OTHER ZONE CONTROL SYSTEMS TESTED**—Pneumatic and solid state modulating control systems have also been tested, but found seriously lacking in several important respects. The solid state modulating control has the serious defect of being extremely complicated to understand and hence difficult to service and adjust in the field. Pneumatic controls are not available to Lennox or any manufacturer on an O.E.M. basis, and, hence, Lennox is unable to sell or supervise installation of them. If pneumatic controls are used with DMS units, Lennox cannot accept responsibility for the end comfort result.

**INTERNAL AIR HANDLING**—Careful attention to detail, thorough isolation of all internal moving parts and maintaining relatively low internal air velocities has allowed Lennox to create the quietest Multi-zone air handler on the market. External vibration measurement showed that the amplitude effect of moderate breezes was greater than the vibratory amplitudes of the DMS and its companion condensing unit which were transmitted to the roof and building structure.

Highly sophisticated and detailed engineering allows the Lennox DMS unit to handle maximum cfm at exceedingly low internal resistances regardless of the position of the mixing dampers. The normal external duct system used with the DMS system will have a relatively much higher static drop than the internal resistance of the DMS unit and, hence, the small changes in static drop produced by the different positions of the mixing damper becomes a negligible part of the total static pressure experienced by the air movers. Hence, an almost constant cfm is supplied to each zone regardless of the position of the Lennox supplied mixing dampers.

**VELOCITY PRESSURE CONVERTERS**—Lennox developed, patent applied for, Velocity Pressure Converters, which are essentially highly sophisticated diverging nozzles, in front of each blower, convert the kinetic energy of the high velocity blower discharge to static pressure to produce nearly laminar air flow within the unit. Laminar air flow not only saves power but also insures excellent air distribution over the evaporator which eliminates erratic hunting of the expansion valves. Also, when Velocity Pressure Converters are not used high velocity air impingement forces air partially through the heat exchanger which then recirculates back to the cooling side adding substantially to the cooling load.

**INTERNAL VIBRATION ISOLATION**—All moving parts within the DMS unit—the motor, blower wheels, shafting, and drive are mounted in a rugged steel subassembly which is then resiliently suspended in the structure of the cabinet. This is the most complete and efficient method of isolating the energy of the blower assembly that has ever been used in the air conditioning industry. Belt tension is easily adjusted by loosening one nut and jacking the hinged motor mounting

base up or down and locking it again with the one nut. The foamed-in-place insulation in the cabinet contributes to deadening the panels producing an extremely quiet unit. All dampers are mounted in self lubricating, non rattling nylon bearings. Lennox compressors are the quietest in the industry. Moving parts are thoroughly floated within the hermetic shell. The condenser fans are floated. There is practically no vibration on the roof.

**HUMIDITY CONTROL**—A surprising amount of humidity control has been designed into the standard DMS control systems. The cool side bypasses a minimum of 0 to 30% which means that even if every zone is calling for full heating some of the air will go through the heating section and from 0 to 30% through the cooling section. Below 58° the compressors are off. Even though the outdoor air is saturated at this temperature it will be comparatively dry when raised to indoor temperatures of around 75°. Above 58° compressors function to maintain a cold coil constantly on the cool side and, with a minimum of 0 to 30% over this coil, you dehumidify this air and then reheat it by mixing it with warm air for those zones calling for heating.

## ACCESSORIES

**ROOF MOUNTING FRAME**—An optional roof mounting frame which exactly fits the perimeter of the DMS unit is also available. This simplifies installation making it easier for the roofer to flash in the frame. The DMS unit then sits on top of this frame and a neoprene sponge gasket in the extruded aluminum base completes the sealing and weather-proofing job. Mounting frame is not insulated.

**NIGHT OPERATION**—In mild climates a "system switch" turns off the entire unit at night. For colder climates a "night protection thermostat" located in an average zone is used. If the night temperature drops below the setting of this thermostat, the system will operate normally until the temperature is satisfied and the system again turns off completely. A practical and attractive plastic dual purpose wall mounting plate is furnished with the night thermostat. It mounts to four standard electrical switch boxes located within the wall. In order to receive the plate, edges of the switch boxes must have at least 3 1/2 inches of clearance to any door or window trimming. The plate itself is finished on both sides for dual mounting purposes. One side is for manual day-nite control, the other side serves automatic day-nite control. Toggle switch and complete mounting instructions are included. A skip-day clock to program this unit automatically is also available. A spring powered carry over feature keeps this timer going in spite of power interruptions of reasonable duration.

**MORNING WARMUP**—In some applications it may be desirable to have morning warmup operation. Lennox has available a simple adjustable thermostat with remote sensing bulb which mounts in the return air stream. If the return air temperature is too cold it closes the outdoor air damper thus heating the conditioned area faster and with less cost. It also closes the outdoor air damper, if the system is ever out of control.

**COMBUSTIBLE ROOF**—When DMS is installed on a combustible curbing use AF3-275-1 adaptor between DMS unit and curbing. When extending supply air plenums (8 zone, 12 zone or double duct) through combustible material adaptor frame AF3-275 must be installed around perimeter of opening.

**IS SPECIAL DUCTWORK REQUIRED?**—Principles of duct design applied to DMS units are exactly the same as principles used with any other air conditioning system. Distribution of the supply air from the DMS should be designed on the basis of good engineering principles applied with any commercial system. If the climate is fairly warm, so that the major work is cooling, ceiling or high side wall supplies should suffice. If the climate is cold and/or the building construction poor, perimeter distribution is preferred.

**STEP DOWN TRANSFORMER**—In areas where 120 volt power is not readily available a special transformer is available to step down the power supply to obtain 120 volt control power.

## APPROVALS

When equipped with our Lennox GX2 Duratube-Duraglass direct-fired gas heat exchanger, the entire DMS unit carries an A.G.A. approval for outdoor use. A.G.A. approved for down-flo installation on combustible material when installed with special AF3-275 base. Special horizontal discharge unit (DMSI-275H) is A.G.A. approved for installation on combustible material.

Electric heat and hot water models will be U. L. listed (listing pending).

All electrical components have a general (white card) listing. The appropriate condensing units carry U. L. listing.

All of the internal wiring is in strict compliance with the National Electric Code, including the local interpretations of which Lennox is aware.

In addition to the wiring requirements by A.G.A. covered in the A.G.A. approval, the following Underwriters Laboratories standards are adhered to:

- Air Conditioners, central cooling (UL-465)
- Condensing Units, refrigeration (UL-303)
- Gas Heating Equipment, commercial-industrial (UL-795)
- Temperature Indicating and Regulating Equipment (UL-873)

## TYPICAL DOUBLE DUCT APPLICATION

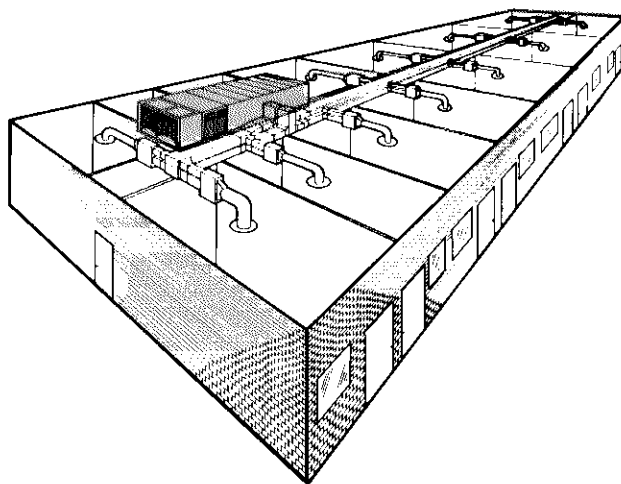

## DMS1 RATINGS AND SPECIFICATIONS

Model Number		➔	DMS1-275
Cooling capacity (Btuh) /S/T Ratio/Compressor watts At ARI standard 210 test conditions	EYMS1-95V evaporator—HS6-953V Condensing unit		‡93,000/.71/9,850
	EYMS1-135V evaporator—HS6-953V Condensing unit		‡100,000/.76/10,300
	EYMS1-135V evaporator—HS6-1353V Condensing unit		‡128,000/.75/13,550
	EYMS1-185V evaporator—HSMI-1853V Condensing unit		201,000/.75/19,400
	EYMS1-275V evaporator—HSMI-1853V Condensing unit		213,000/.79/19,900
	EYMS1-275V evaporator—HSMI-2753V Condensing unit		281,000/.78/27,500
*Gas heating capacity (Btuh)	GX2-250	Minimum input/output	125,000/93,750
		Maximum input/output	250,000/187,500
	GX2-350	Minimum input/output	175,000/131,250
		Maximum input/output	350,000/262,500
	GX2-500	Minimum input/output	250,000/187,500
		Maximum input/output	500,000/375,000
*Electric heating capacity (Btuh) At 240 volts input	EX1-1543—45 Kw—3 steps		153,500
	EX1-2053—60 Kw—4 steps		205,000
	EX1-2563—75 Kw—5 steps		256,000
	EX1-3073—90 Kw—6 steps		307,000
	EX1-3583—105 Kw—7 steps		358,000
*WX1-275 Hot water coil heating capacity (Btuh)	Minimum		100,000
	Maximum		700,000
Gas piping connection (in.)	Natural		1
	LPG		3/4
‡Recommended gas supply pressure WC (in.)			6
Hot water coil connection (o.d. in. copper)	Inlet		see water valve selection curve
	Outlet		
Evaporator Coil	EYMS1-95V (3 row) EYMS1-135V (4 row)	Net face area (sq. ft.)	10.2
		Tube diameter (in.)	1/2
		Fins per inch	10
	EYMS1-185V (4 row) EYMS1-275V (6 row)	Net face area (sq. ft.)	14.1
		Tube diameter (in.)	1/2
		Fins per inch	13
Hot Water Coil	WX1-275 (3 row)	Net face area (sq. ft.)	10.2
		Tube diameter (in.)	1/2
		Fins per inch	10
Blower motor horsepower	Minimum		2
	Maximum		7 1/2
Blower wheel nominal diameter x width (in.)			(2) 15 x 15
Air volume range (cfm)			5000-10,500
Condensate drain connections I.P.M. (in.)			1 1/4
Electrical characteristics			208 to 600V/60cy/3φ

\*Heat source options ‡ARI Certified ratings.

NOTE—Hot water coil capacity ranges shown are possible with varying flow rate, water temperature and air volume. See coil capacity curve.

NOTE—Complete specifications on HSMI condensing units are on page 29 of this section. HS6 specifications are indexed in section COOLING UNITS—Condensing Units.

### NET WEIGHT (lbs.)

DMS1-275 Without Coils Heating Sections or Blower Drives	To arrive at gross weight of a complete DMS unit, total the weights of the required components listed below and add this weight to the DMS1-275 weight in left hand column.																	
	Gas Heat Section		Electric Heat Section					WX1-275 3 row Hot Water Coil	EYMS1- 95V DX Coil	EYMS1- 135V DX Coil	EYMS1- 185V DX Coil	EYMS1- 275V DX Coil	Motor & Drives			Distribution System		
	GX2-250 & GX2-350	GX2-500	45 Kw	60 Kw	75 Kw	90 Kw	105 Kw						2 Hp	3 Hp	5 Hp	8 Zone	12 Zone	Double Duct
1458	285	310	173	182	192	200	211	147	166	196	233	268	74		110	*360	*415	46

\*Based on one damper motor per each zone. NOTE—See condensing unit specifications for condensing unit weight.

## GUIDE SPECS

Prepared for the guidance of architects, consulting engineers and mechanical contractors.

**General**—Furnish and install a multizone heating-cooling unit with all controls, ducts and zone dampers.

The Multizone system shall be a standard product of a firm regularly engaged in the manufacture of heating-cooling equipment. The manufacturer shall have dealers and service available throughout the United States.

The installed equipment including condensing unit shall have a roof loading no greater than 27 lbs per sq ft. The total installed weight less ducts shall not be more than ..... lbs.

**Roof Mounting Frame**—A steel mounting frame shall be furnished. It shall conform exactly to the shape of the system and be contoured to accept the base of the equipment. The flashing shall be the responsibility of a bonded roofing contractor.

**Air Distribution**—Shall be either (double duct or zone dampers located at the unit).

All air distribution ducts shall be insulated with ..... inch thick ..... lb density fiberglass or equivalent.

**DX Cooling System**—The total certified cooling capacity shall not be less than ..... Btuh with an evaporator air volume of ..... cfm, an entering wet bulb air temperature of ..... F and outdoor air temperature of ..... F. The compressor power input shall not exceed ..... kw at the above conditions.

The coils shall be non-ferrous construction with aluminum fins mechanically bonded to seamless copper tubes.

The 16 and 22 ton evaporator coil shall be 50/50 split with each section having an expansion valve. The condenser coil shall have sub-cooling rows. All coils shall be factory pressure leak tested at 450-500 psi.

Condensing unit shall have spring mounted compressor(s). Compressor(s) shall have built in 3 mode crankshaft lubrication, crankcase heater, discharge temperature limiter, current and temperature sensing motor overloads and be guaranteed for five years.

**Gas Heating System**—The certified total heating capacity output shall be ..... Btuh with a gas input of ..... Btuh. Automatic controls furnished shall give 50/50 two stage operation.

Cylindrical tube and drum heat exchanger shall be constructed of aluminized steel. Heat exchanger shall be capable of handling 100% outdoor air at any temperature and have a 10 year warranty when handling uncontaminated air. Stainless steel power burner shall have intermittent spark ignition, 100% safety shutoff controls and electronic flame sensing controls.

**Hot Water Heating System**—The certified total heating capacity output shall be ..... Btuh, at a water entering temperature of ..... F and a flow rate of ..... gpm.

A three way modulating water valve (with-without) primary pump shall be factory installed.

The coil shall be of non-ferrous construction with aluminum fins mechanically bonded to seamless copper tubes.

**Electric Heating System**—The certified total heating capacity output shall be ..... Btuh with ..... kw input at ..... volts power supply.

Heating elements shall be nichrome bare wire exposed directly to the air stream and be equipped with fusible links. They shall be controlled by a (modulating sequencer or two stage controller).

**Controls**—All controls shall be the sole responsibility of the mechanical equipment manufacturer and shall be installed, wired and tested.

**Fresh Air Control**—Shall include an outside reset ductstat with 240 inch long element which shall be provided upstream from the cooling coil. It shall command a modulating damper motor which has an adjustable potentiometer for minimum position. An adjustable outdoor air thermostat shall return the damper motor to the minimum position at the outdoor air temperature setting on the control (usually 65F).

**DX Cold Deck Controls**—Shall include an adjustable outdoor air temperature controller which senses outdoor air temperature and deactivates the cooling system at the adjustable setting on the control (usually 60F).

16 and 22 Ton Two stage compressor operation shall have modulated capacity control of the first stage system. Both DX cooling stages and unloading shall be controlled by suction temperature.

8 and 11 Ton—Single stage compressor operation shall have capacity reduction controlled by the suction temperature.

**Gas Heat Hot Deck Controls**—Shall include an adjustable outside reset ductstat which two stage controls the heat section to maintain a hot deck air temperature appropriate to the outdoor air temperature.

**Electric Heat Hot Deck Controls**—Shall include an adjustable outside reset ductstat which (two stage or modulates) the heat section to maintain a hot deck air temperature appropriate to the outdoor air temperature.

**Hot Water Heat Hot Deck Controls**—Shall include an adjustable outside reset ductstat which modulates a three way water valve to maintain a hot deck air temperature appropriate to the outdoor air temperature.

**Zone Controls**—Shall be either a (three position or modulating) zone damper motor which is controlled by a two mercury bulb, wall mounted thermostat.

**Air Mover**—Twin supply air blowers shall have permanently lubricated ball bearings, have adjustable belt drives and be capable of delivering ..... cfm at an external static pressure of ..... inches water gauge requiring ..... bhp and ..... rpm.

**Mixing Damper and Filter**—Damper blades shall be edge lined with urethane foam and ride in nylon bearings. Damper motor shall be full modulating with adjustable potentiometer for minimum position. Washable-vacuum cleanable filter shall be one inch thick with a total free filter area of ..... sq ft.

**Frame and Casing**—Base frame shall be of aluminum extrusions shaped to mate with the roof mounting frame. Interior support members shall be 16 ga. steel painted with outdoor acrylic enamel. Casing shall be of .040 color weld aluminum. All access panels shall have locking door handles. Panels shall be lined with 1" thick close cell foil covered insulation. The bottom of unit shall be able to serve as a safety water pan.

**Approvals**—All models shall be A.G.A. Certified or U.L. Listed whichever applies to heat source used. The (condensing units or water chillers) shall be U.L. Listed. All wiring shall be in compliance with NEC. The following Underwriters' Laboratories Standards shall apply:

Air Conditioners, central cooling (UL-465)

Condensing Units, refrigeration (UL-303)

Gas Heating Equipment, commercial-industrial (UL-795)

Temperature Indicating and Regulating Equipment (UL-873)

## DMS1-275 ELECTRICAL DATA

Voltage <span style="font-size: small;">→</span>			208	220/240	440/480	550/600
DMS1-275 Blower Motor	2hp	Full load amps	6.6	6.2	3.1	2.5
		Locked rotor amps	43.5	41.0	20.5	15.0
	3hp	Full load amps	9.9	9.0	4.5	3.6
		Locked rotor amps	55.0	50.0	25.0	20.0
	5hp	Full load amps	16.5	15.0	7.5	6.0
		Locked rotor amps	83.6	76.0	38.0	32.0
	7½	Full load amps	25.4	23.0	11.5	9.2
		Locked rotor amps	155.0	140.0	70.0	56.0
Step down control transformer (amps)			9.6	8.3	4.2	3.3
*Pressure relief fan		Full load amps	*7.8	*7.8	*7.8	*7.8
		Locked rotor amps	33.4	33.4	33.4	33.4
*GX2 gas heat (amps)			*4.11	*4.11	*4.11	*4.11
*Hot water heat		Valve (amps)	*.32	*.32	*.32	*.32
		Pump (amps)	*.26	*.26	*.26	*.26
Electric Heat (amps)		EXI-1543	93.5	99/108	49.5/54	39.7/43.3
		EXI-2053	124.7	132/144	66/72	52.9/57.7
		EXI-2563	156.0	165/180	82.5/90	66.2/72.2
		EXI-3073	187.2	198/216	99/108	79.4/86.6
		EXI-3853	218.3	231/252	115.5/126	92.5/101.0

\*Rated at 115V (part of step down control transformer if used). Separate 115V power source is required if transformer is not used, it must be sized for not less than 15.0 amps load.

## FIELD WIRING

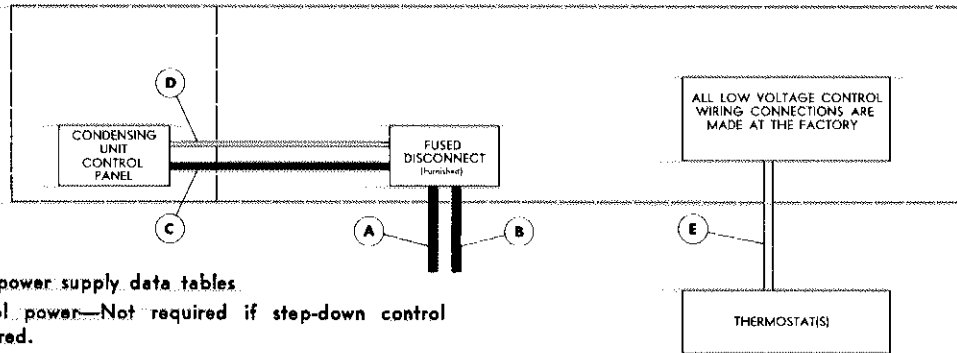

- A—3 wire power—See power supply data tables.
- B—2 wire 115V control power—Not required if step-down control transformer is ordered.
- C—3 wire condensing unit power—Furnished for HSM1 models, field connection required. Not furnished for HS6 models, see following table for HS6 wire sizes.

Model No.	Wire Size AWG at Available Voltages			
	208V	220/240V	440/480V	550/600V
HS6-953V	6	6	10	12
HS6-1353V	4	4	10	10

- D—2 wire low voltage—Furnished for HSM1 models, field connection required. Not furnished for HS6 models, 18 ga. minimum required.
- E—18 ga. low voltage control wiring furnished 18 inches external to DMS1 unit—Installer must furnish 3 wire low voltage thermostat cable to each thermostat.

NOTE—All wiring must conform to NEC and local codes.

## POWER SUPPLY DATA

### GAS OR HOT WATER HEATING AND AIR CONDITIONING POWER SUPPLY DATA

(Amps include step down control transformer for 120V control power. Wire sizes include 125% of the largest motor amp draw.)

Voltage	Amps Wire Size (AWG) Disconnect (Amps)	Gas or Hot Water Heating and Air Conditioning															
		Gas or Hot Water Heating Only				Gas or Hot Water Heating and Air Conditioning											
		Blower Motor Hp				HS6-953V		HS6-1353V		HSM1-1853V				HSM1-2753V			
		2	3	5	7½	2	3	2	3	2	3	5	7½	2	3	5	7½
208 Volts 60 cy - 3φ	Amps	16.2	19.5	26.1	35.0	54.0	57.3	64.3	67.6	85.8	89.1	95.7	104.6	111.2	114.5	121.1	130.0
	Wire Size	12	10	8	6	4	4	3	2	2	1	1	0	0	00	00	00
	*Disconnect	60	60	60	60	60	100	100	100	100	100	100	200	200	200	200	200
220/240v 60 cy - 3φ	Amps	14.5	17.3	23.3	31.3	49.5	52.4	60.2	63.0	78.7	81.5	87.5	95.5	104.7	107.5	113.5	121.5
	Wire Size	12	12	10	8	4	4	3	3	2	2	1	1	0	0	0	00
	*Disconnect	60	60	60	60	60	100	100	100	100	100	100	200	200	200	200	200
440/480v 60 cy - 3φ	Amps	7.3	8.7	11.7	15.7	24.9	26.3	30.2	31.6	39.5	40.9	43.9	47.9	52.3	53.7	56.7	60.7
	Wire Size	14	14	14	12	8	8	8	8	6	6	6	6	4	4	4	4
	*Disconnect	60	60	60	60	60	60	60	60	60	60	60	60	100	100	100	100
550/600v 60 cy - 3φ	Amps	5.8	6.9	9.3	12.5	19.9	21.0	24.6	25.7	31.6	32.7	35.1	38.3	41.8	42.9	45.3	48.5
	Wire Size	14	14	14	12	10	10	8	8	8	8	8	6	6	6	6	6
	*Disconnect	60	60	60	60	60	60	60	60	60	60	60	60	60	60	60	60

\*Furnished and factory installed. Sized according to its Hp. rating.  
 NOTE—Wire is sized for 1' to 100' of run. For runs of 101' to 200' use next size larger wire.  
 NOTE—Local codes take precedence



# POWER SUPPLY DATA

## ELECTRIC HEATING AND AIR CONDITIONING POWER SUPPLY DATA

(Amps include step down control transformer for 120V control power. Wire sizes include 125% of the largest motor amp draw)

Voltage		ELECTRIC HEAT RATINGS					POWER SUPPLY DATA																	
		EX1 Model Number	Kw Input	No. of Steps	Total Heating Capacity (Btuh)	Max Unit Amps Wire Size (AWG) *Disconnect (amps)	Electric Heat Only or with Air Conditioning HS6-953V or HS6-1353V					Electric Heat with Air Conditioning HSM1-1853V					HSM1-2753V							
							Blower Motor Hp		Blower Motor Hp		Blower Motor Hp		Blower Motor Hp		Blower Motor Hp		Blower Motor Hp		Blower Motor Hp					
2	3	5	2	3	5	2	3	5	2	3	5	2	3	5	2	3	5	2	3	5	7 1/2			
208V, 60 cy - 3φ	EX1-1543	33.75	3	110,500	Amps Wire Size	109.7 0	113.0 0	119.6 0	117.0 0	120.3 0	126.9 0	135.8 0	142.4 0	145.7 0	152.3 0	161.2 0	0000 0000	0000 0000	0000 0000	0000 0000	0000 0000	0000 0000	0000 0000	
	EX1-2053	45	4	153,500	Amps Wire Size	140.9 0	144.2 0	150.8 0	140.9 0	144.2 0	150.8 0	159.7 0	142.4 0	145.7 0	152.3 0	161.2 0	0000 0000	0000 0000	0000 0000	0000 0000	0000 0000	0000 0000	0000 0000	
	EX1-2563	56.25	5	194,500	Amps Wire Size	172.2 0000	0000 0000	0000 0000	172.2 0000	0000 0000	0000 0000	0000 0000	0000 0000	0000 0000	0000 0000	0000 0000	0000 0000	0000 0000	0000 0000	0000 0000	0000 0000	0000 0000	0000 0000	
	EX1-1543	37.8/45	3	129,000/153,500	Amps Wire Size	122.5 0	125.3 0	131.3 0	122.5 0	125.3 0	131.3 0	139.3 0	140.7 0	143.5 0	149.5 0	157.5 0	0000 0000	0000 0000	0000 0000	0000 0000	0000 0000	0000 0000	0000 0000	0000 0000
	EX1-2053	50.5/60	4	172,000/205,000	Amps Wire Size	158.5 0	161.3 0	167.3 0	158.5 0	161.3 0	167.3 0	175.3 0	158.5 0	161.3 0	167.3 0	175.3 0	0000 0000	0000 0000	0000 0000	0000 0000	0000 0000	0000 0000	0000 0000	0000 0000
440/480V, 60 cy - 3φ	EX1-1543	37.8/45	3	129,000/153,500	Amps Wire Size	61.3 4	62.7 4	65.7 4	61.3 4	62.7 4	65.7 4	69.7 3	70.3 3	71.7 3	74.7 2	78.7 2	0000 0000	0000 0000	0000 0000	0000 0000	0000 0000	0000 0000	0000 0000	0000 0000
	EX1-2053	50.5/60	4	172,000/205,000	Amps Wire Size	79.3 2	80.7 2	83.7 2	79.3 2	80.7 2	83.7 2	87.7 2	79.3 2	80.7 2	83.7 2	87.7 2	0000 0000	0000 0000	0000 0000	0000 0000	0000 0000	0000 0000	0000 0000	0000 0000
	EX1-2563	63/75	5	215,000/256,000	Amps Wire Size	97.3 1	98.7 1	101.7 1	97.3 1	98.7 1	101.7 1	105.7 1	97.3 1	98.7 1	101.7 1	105.7 1	0000 0000	0000 0000	0000 0000	0000 0000	0000 0000	0000 0000	0000 0000	0000 0000
	EX1-3073	75.5/90	6	260,000/308,000	Amps Wire Size	115.3 0	116.7 0	119.7 0	115.3 0	116.7 0	119.7 0	123.7 0	115.3 0	116.7 0	119.7 0	123.7 0	0000 0000	0000 0000	0000 0000	0000 0000	0000 0000	0000 0000	0000 0000	0000 0000
	EX1-3583	88/105	7	302,500/359,000	Amps Wire Size	133.3 0	134.7 0	137.7 0	133.3 0	134.7 0	137.7 0	141.7 0	133.3 0	134.7 0	137.7 0	141.7 0	0000 0000	0000 0000	0000 0000	0000 0000	0000 0000	0000 0000	0000 0000	0000 0000
550/600V, 60 cy - 3φ	EX1-1543	37.8/45	3	129,000/153,500	Amps Wire Size	60 6	60 6	60 6	60 6	60 6	60 6	60 6	60 6	60 6	60 6	60 6	0000 0000	0000 0000	0000 0000	0000 0000	0000 0000	0000 0000	0000 0000	0000 0000
	EX1-2053	50.5/60	4	172,000/205,000	Amps Wire Size	63.5 4	64.6 4	67.0 4	63.5 4	64.6 4	67.0 4	70.2 3	63.5 4	64.6 4	67.0 4	70.2 3	0000 0000	0000 0000	0000 0000	0000 0000	0000 0000	0000 0000	0000 0000	0000 0000
	EX1-2563	63/75	5	215,000/256,000	Amps Wire Size	78.0 3	79.1 2	81.5 2	78.0 3	79.1 2	81.5 2	84.7 2	78.0 3	79.1 2	81.5 2	84.7 2	0000 0000	0000 0000	0000 0000	0000 0000	0000 0000	0000 0000	0000 0000	0000 0000
	EX1-3073	75.5/90	6	260,000/308,000	Amps Wire Size	92.4 2	93.5 1	95.9 1	92.4 2	93.5 1	95.9 1	99.1 1	92.4 2	93.5 1	95.9 1	99.1 1	0000 0000	0000 0000	0000 0000	0000 0000	0000 0000	0000 0000	0000 0000	0000 0000
	EX1-3583	88/105	7	302,500/359,000	Amps Wire Size	106.8 1	107.9 1	110.3 0	106.8 1	107.9 1	110.3 0	113.5 0	106.8 1	107.9 1	110.3 0	113.5 0	0000 0000	0000 0000	0000 0000	0000 0000	0000 0000	0000 0000	0000 0000	0000 0000

\*Furnished and factory installed. Sized according to its Hp rating.  
 Note—Wire is sized for 1' to 100' of run. For runs of 101' to 200' use next largest wire size. Local codes take precedence.

# DIMENSIONS (in.)

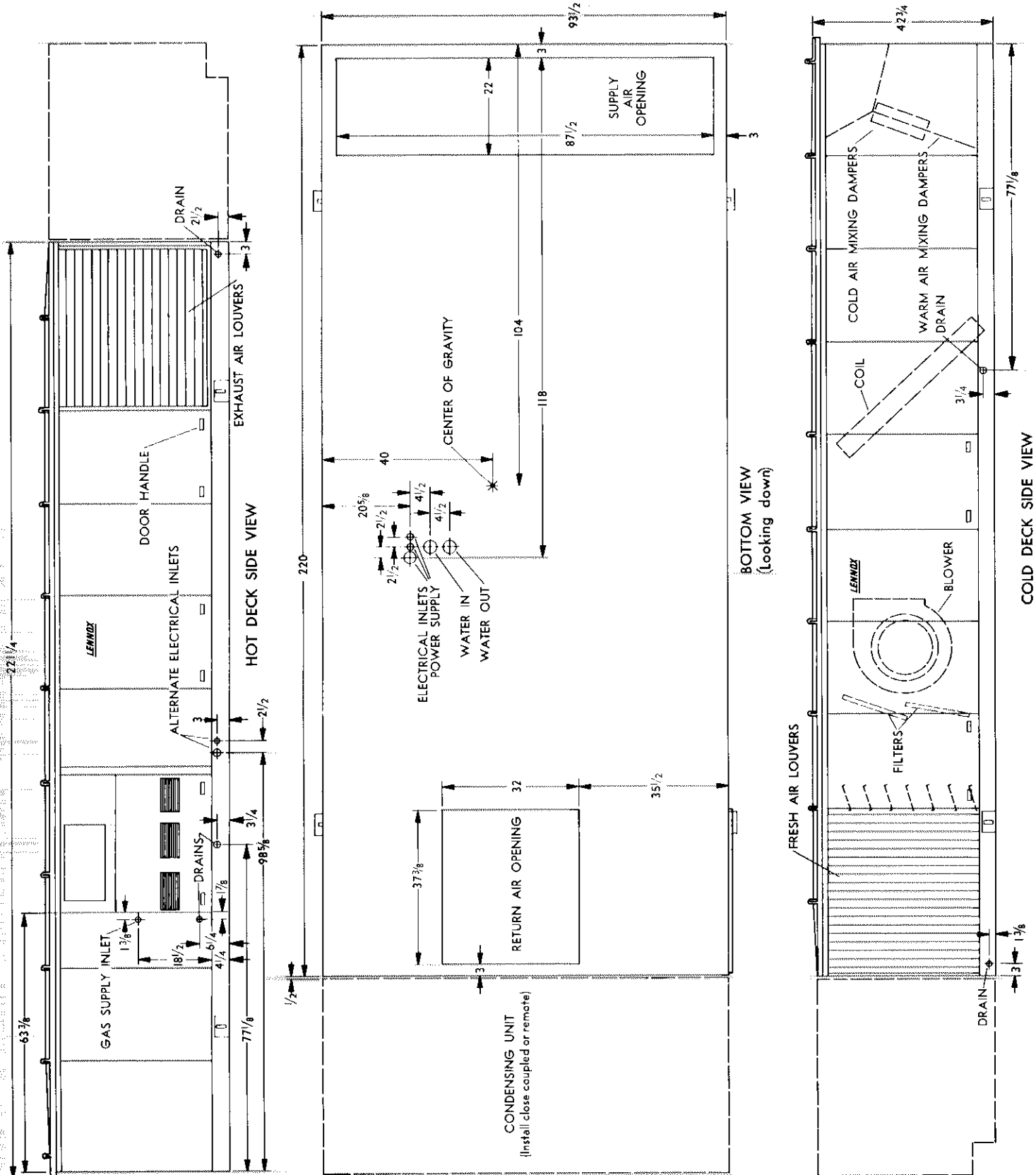

# DIMENSIONS (in.)

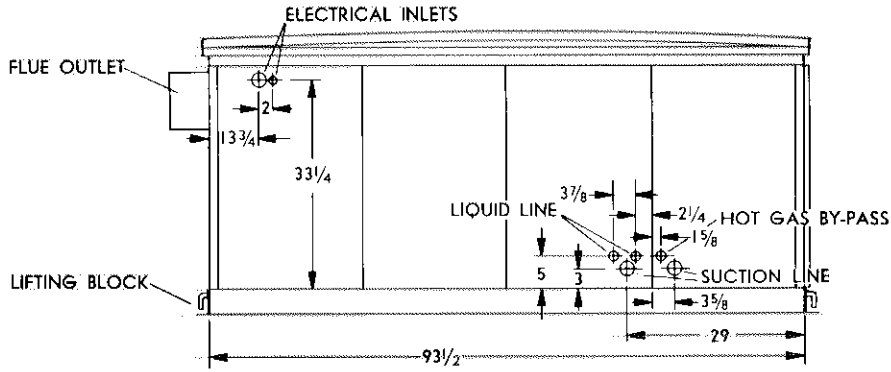

## RETURN AIR END

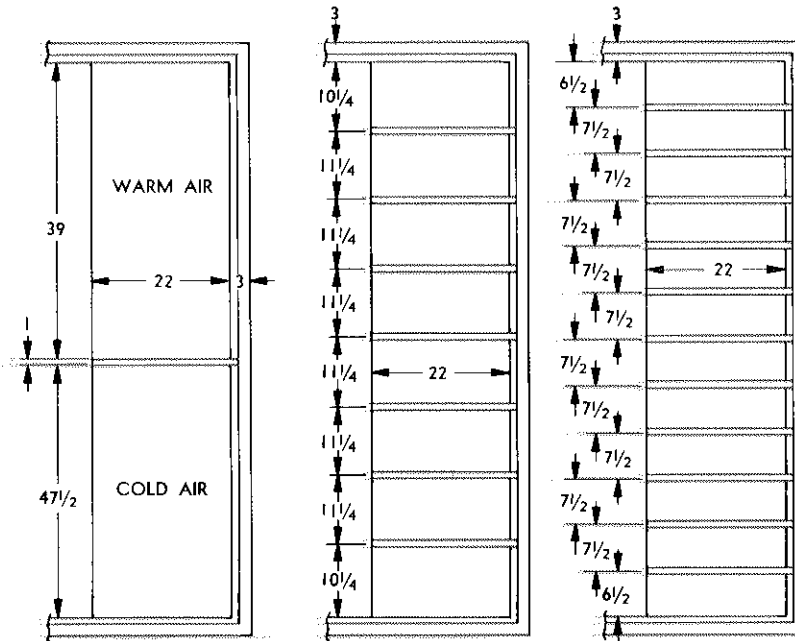

SUPPLY AIR CONNECTIONS FOR DOUBLE DUCT APPLICATIONS

SUPPLY AIR CONNECTIONS FOR 8 OR LESS ZONES

SUPPLY AIR CONNECTIONS FOR 12 OR LESS ZONES

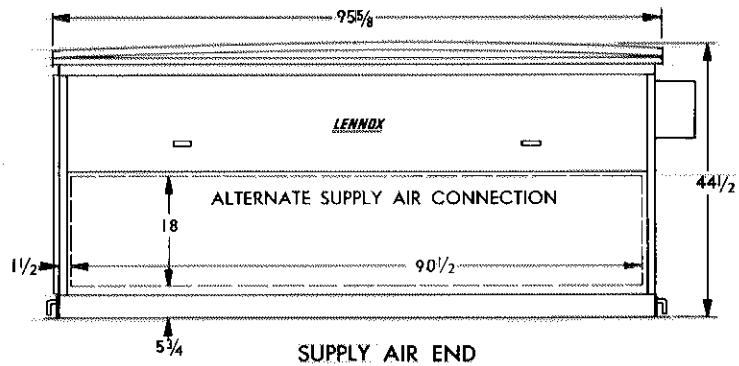

## ZONE DAMPER AIR VOLUME (cfm)

No. of Zones	Minimum	Nominal	Maximum
8 zone	550	1200	1550
12 zone	350	800	950

## BLOWER DATA

NOTE—Performance shown is with 50% of zones calling for cooling and 50% for heating or with dampers in the intermediate position and with 20% outdoor air entry. This condition has the greatest hp requirement.

### DMS1-275 BLOWER PERFORMANCE—EVMS1-95V OR EVMS1-135V EVAPORATOR COIL (With Multizone Distribution Plenum)

Air Volume (cfm)	STATIC PRESSURE EXTERNAL TO UNIT (Inches Water Gauge)											
	0	.10	.20	.30	.40	.50	.60	.70	.80	.90	1.00	
	RPM BHP	RPM BHP	RPM BHP	RPM BHP	RPM BHP	RPM BHP	RPM BHP	RPM BHP	RPM BHP	RPM BHP	RPM BHP	
3500	320 0.1	330 0.1	390 0.1	430 0.2	470 0.3	510 0.4	540 0.5	570 0.6	600 0.7	625 0.8	650 0.9	
4000	335 0.1	365 0.1	415 0.2	450 0.3	500 0.4	535 0.5	560 0.6	590 0.7	620 0.8	650 0.9	670 1.0	
4500	360 0.1	400 0.2	440 0.3	480 0.4	520 0.5	555 0.6	585 0.7	620 0.8	640 0.9	670 1.0	695 1.1	
5000	390 0.4	430 0.5	470 0.6	510 0.7	540 0.8	575 0.9	610 1.0	635 1.1	665 1.2	690 1.3	720 1.4	
5500	410 0.6	455 0.7	500 0.8	535 0.9	565 1.0	600 1.1	630 1.2	660 1.3	690 1.4	720 1.5	745 1.6	
6000	445 0.9	495 1.0	525 1.1	565 1.2	600 1.3	630 1.4	655 1.5	685 1.6	715 1.8	740 1.9	770 2.0	
6500	490 1.1	525 1.2	565 1.4	600 1.5	630 1.6	655 1.7	685 1.9	715 2.0	740 2.1	770 2.2	800 2.4	
7000	520 1.4	560 1.5	600 1.7	630 1.9	660 2.0	690 2.1	715 2.2	745 2.3	770 2.5	800 2.7	825 2.8	
7500	560 1.7	600 1.8	630 2.0	660 2.1	685 2.3	720 2.5	745 2.7	775 2.8	800 2.9	825 3.1	845 3.2	

### DMS1-275 BLOWER PERFORMANCE—EVMS1-95V OR EVMS1-135V EVAPORATOR COIL (With Double Duct Plenum)

Air Volume (cfm)	STATIC PRESSURE EXTERNAL TO UNIT (Inches Water Gauge)											
	0	.10	.20	.30	.40	.50	.60	.70	.80	.90	1.00	
	RPM BHP	RPM BHP	RPM BHP	RPM BHP	RPM BHP	RPM BHP	RPM BHP	RPM BHP	RPM BHP	RPM BHP	RPM BHP	
3500	315 0.1	365 0.1	390 0.1	425 0.1	460 0.2	495 0.3	530 0.4	565 0.5	600 0.6	630 0.7	655 0.8	
4000	340 0.1	380 0.1	410 0.2	445 0.3	480 0.4	515 0.5	550 0.6	585 0.7	615 0.8	640 0.9	675 1.0	
4500	365 0.2	390 0.3	430 0.4	465 0.5	500 0.6	535 0.7	570 0.8	600 0.9	635 1.0	660 1.1	690 1.2	
5000	380 0.3	420 0.4	455 0.5	490 0.6	525 0.7	560 0.8	590 0.9	625 1.0	655 1.1	685 1.2	710 1.3	
5500	410 0.6	440 0.7	475 0.8	510 0.9	545 1.0	580 1.1	615 1.2	645 1.3	670 1.4	700 1.5	725 1.6	
6000	435 0.8	465 0.9	500 1.0	535 1.1	575 1.2	600 1.3	630 1.4	660 1.5	695 1.6	720 1.7	745 1.8	
6500	460 1.1	490 1.2	525 1.3	565 1.4	600 1.5	630 1.6	655 1.7	685 1.8	710 2.0	735 2.1	760 2.2	
7000	485 1.3	520 1.4	555 1.5	590 1.6	625 1.8	655 1.9	685 2.0	710 2.2	735 2.3	765 2.4	790 2.6	
7500	510 1.6	550 1.7	590 1.8	615 2.0	645 2.1	675 2.3	710 2.4	735 2.5	760 2.7	785 2.8	810 3.0	

### DMS1-275 BLOWER PERFORMANCE—EVMS1-185V OR EVMS1-275V EVAPORATOR COIL (With Multizone Distribution System)

Air Volume (cfm)	STATIC PRESSURE EXTERNAL TO UNIT—Inches Water Gauge											
	0	.10	.20	.30	.40	.50	.60	.70	.80	.90	1.00	
	RPM BHP	RPM BHP	RPM BHP	RPM BHP	RPM BHP	RPM BHP	RPM BHP	RPM BHP	RPM BHP	RPM BHP	RPM BHP	
5000	340 0.6	390 0.7	435 0.8	475 0.9	520 1.0	550 1.1	585 1.2	625 1.3	650 1.4	675 1.5	710 1.6	
5500	380 0.7	430 0.8	475 0.9	510 1.0	545 1.1	575 1.3	620 1.4	645 1.5	675 1.6	700 1.7	735 1.8	
6000	430 0.9	475 1.1	510 1.2	540 1.3	575 1.4	615 1.5	640 1.6	670 1.7	700 1.8	725 1.9	760 2.0	
6500	465 1.2	515 1.3	540 1.4	570 1.6	615 1.7	640 1.7	660 1.8	695 1.9	720 2.1	750 2.1	780 2.2	
7000	510 1.4	540 1.6	570 1.7	610 1.8	640 1.9	660 1.9	690 2.1	725 2.2	750 2.4	775 2.4	800 2.6	
7500	550 1.7	580 1.8	610 1.9	640 2.1	660 2.2	690 2.2	725 2.5	750 2.6	775 2.7	800 2.8	820 3.1	
8000	575 2.0	610 2.1	640 2.3	670 2.4	690 2.5	725 2.7	750 2.9	775 3.0	800 3.2	825 3.3	850 3.6	
8500	620 2.4	640 2.5	670 2.6	700 2.8	725 3.0	750 3.2	780 3.4	805 3.5	825 3.7	850 3.8	875 4.1	
9000	645 2.7	670 2.8	700 3.1	735 3.3	760 3.4	780 3.6	815 3.9	830 4.1	850 4.2	875 4.3	900 4.6	
9500	680 3.2	705 3.4	735 3.6	760 3.8	780 3.8	815 4.3	840 4.4	855 4.6	880 4.7	900 4.9	925 5.2	
10,000	715 3.7	745 3.9	775 4.2	790 4.3	825 4.5	840 4.7	870 5.0	885 5.2	905 5.4	930 5.6		
10,500	750 4.3	775 4.6	810 4.9	830 5.1	850 5.2	870 5.4	890 5.5	910 5.7				

## BLOWER DATA

### DMS1-275 BLOWER PERFORMANCE—EVMS1-185V OR EVMS1-275V EVAPORATOR COIL (With Double Duct Plenum)

Air Volume (cfm)	STATIC PRESSURE EXTERNAL TO UNIT (Inches Water Gauge)																					
	0		.10		.20		.30		.40		.50		.60		.70		.80		.90		1.00	
	RPM	BHP	RPM	BHP	RPM	BHP	RPM	BHP	RPM	BHP	RPM	BHP	RPM	BHP	RPM	BHP	RPM	BHP	RPM	BHP	RPM	BHP
5000	380	0.3	400	0.4	435	0.5	470	0.6	510	0.7	540	0.8	575	0.9	610	1.0	635	1.1	665	1.2	695	1.3
5500	390	0.4	420	0.5	460	0.7	500	0.9	530	1.0	565	1.1	600	1.2	630	1.3	655	1.4	685	1.5	710	1.6
6000	410	0.7	445	0.8	480	0.9	520	1.1	555	1.2	590	1.3	615	1.4	650	1.5	680	1.6	710	1.8	730	1.9
6500	440	1.0	475	1.1	510	1.2	540	1.3	575	1.4	610	1.5	640	1.6	670	1.8	700	1.9	725	2.0	745	2.1
7000	465	1.2	500	1.3	535	1.5	565	1.6	600	1.7	630	1.8	660	1.9	690	2.1	720	2.2	745	2.3	770	2.5
7500	490	1.4	525	1.6	565	1.7	600	1.9	625	2.0	650	2.1	685	2.3	715	2.4	740	2.6	760	2.7	790	2.9
8000	520	1.7	555	1.9	590	2.0	625	2.2	650	2.3	685	2.5	710	2.6	735	2.7	760	2.9	785	3.0	810	3.2
8500	550	2.1	585	2.2	615	2.3	645	2.5	675	2.7	710	2.9	735	3.0	760	3.2	785	3.3	810	3.5	835	3.7
9000	580	2.5	615	2.6	645	2.7	675	2.9	710	3.1	735	3.3	760	3.4	785	3.5	810	3.8	835	4.0	855	4.2
9500	615	2.8	650	3.0	680	3.2	710	3.4	735	3.6	760	3.8	785	3.9	810	4.1	835	4.4	855	4.6	875	4.7
10,000	650	3.3	685	3.5	710	3.7	735	3.9	760	4.1	785	4.3	810	4.5	835	4.7	855	4.9	875	5.1	900	5.3
10,500	685	3.7	715	3.9	740	4.2	765	4.4	790	4.6	810	4.8	835	5.0	860	5.2	880	5.4	900	5.7		

## DRIVE SELECTION

Using total Air Volume (cfm) and system Static Pressure External to Unit (inches water gauge) requirements determine from Blower Performance Chart Rpm and Bhp required for job. Specify Bhp, exact Rpm

and power characteristics required when ordering. The correct motor and pulleys will be factory installed. The following table lists Motor hp and Rpm range of the drive setups available with each motor.

Nominal Motor Hp	Maximum Usable Hp	*Rpm Range Of All Available Drive Setups @ 1720 RPM Motor Speed
2	2.30	400-803
3	3.45	659-879
5	5.75	745-960
7 1/2	8.63	765-970

\*Specify exact Bhp, Rpm and power characteristics required when ordering unit.  
NOTE: The maximum usable hp of motors furnished by Lennox are shown in table. If other motors of comparable hp are used be sure to keep within the service factor limitations outlined on the motor name plate.

## WATER VALVE SELECTION AND WATER COIL PRESSURE DROP

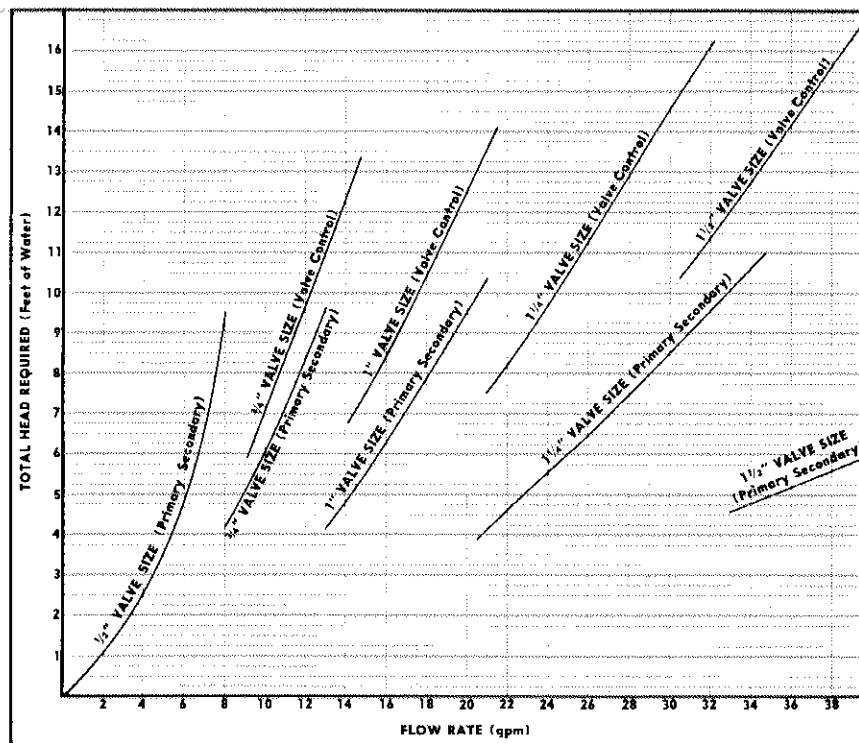

# MOUNTING DETAILS

## MF-275 MOUNTING FRAME

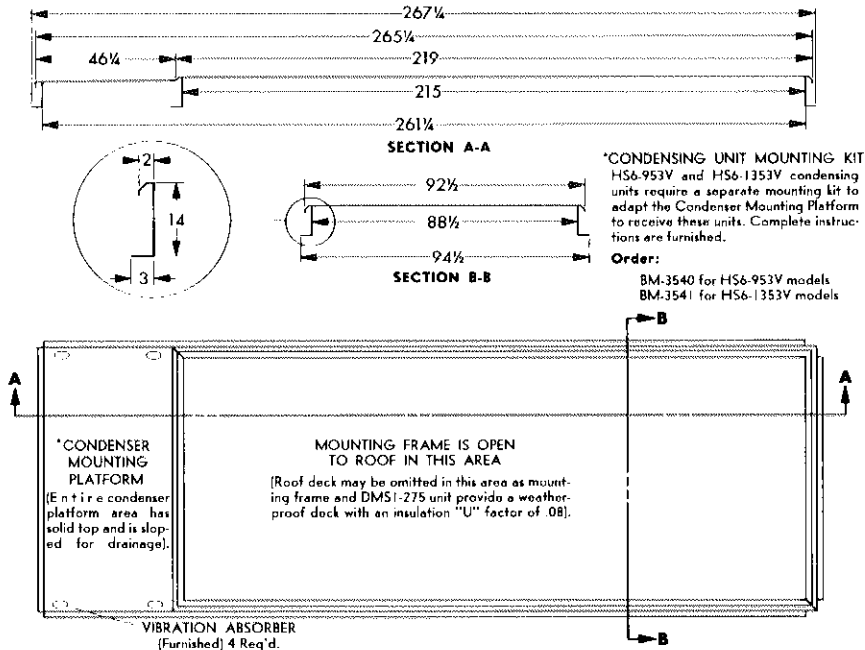

### RUGGED AND PRACTICAL

Makes a perfect mounting curb to receive the direct multizone unit. It is built into the roof structure during building construction. When installed as recommended below it is completely weatherproof and water proof. No additional curbing materials are required.

SEE MOUNTING  
DETAIL BELOW

NOTE—Mounting frame flashing is provided by roofing contractor.

### RECOMMENDED FLASHING FOR MF-275 MOUNTING FRAME

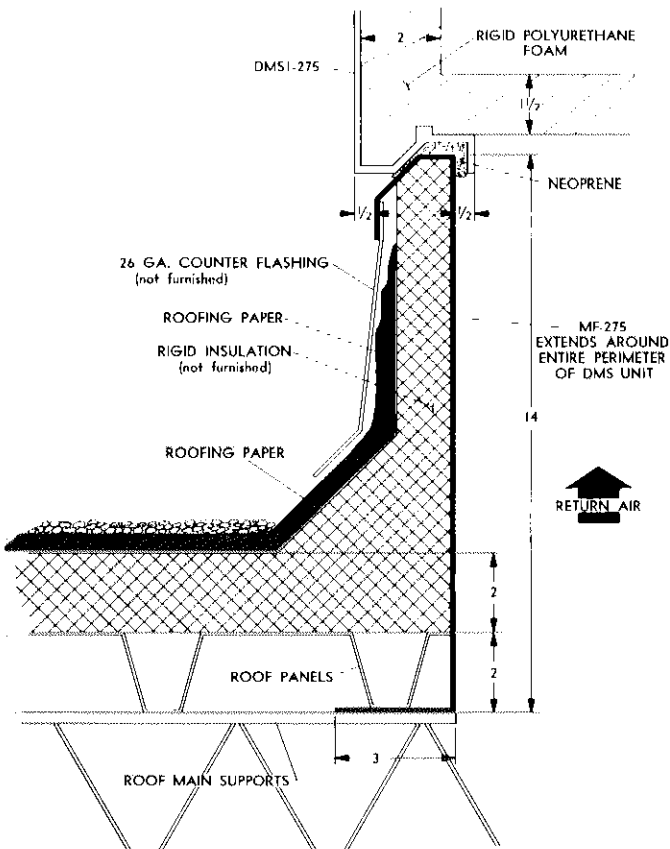

### DOUBLE DUCT PLENUM

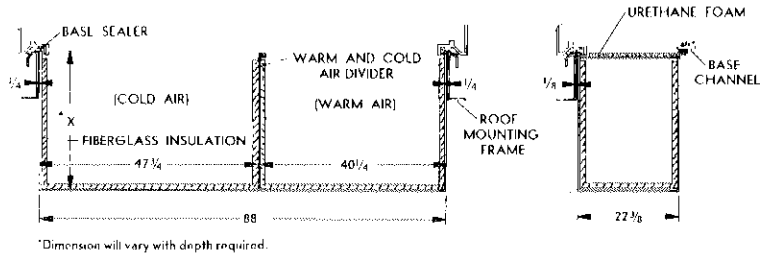

### ZONE DAMPER ASSEMBLY

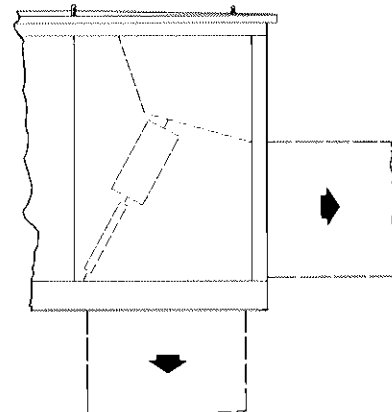

Supply ducts connect to end or bottom of zone damper assembly

## MIXING BOXES

Compact mixing damper boxes for double duct applications easily fit into false ceiling space, tunnel in a slab or any convenient indoor location that lends itself to proper air distribution. Damper motor and linkage are factory installed for horizontal applications. If up-flo or down-flo air pattern is desired, the damper motor must be repositioned, keeping the motor shaft horizontal. (See drawings below). ZDI Series mixing boxes use the Len-

nox 3-position damper motor. The ZD2 Series boxes use an M-H modulating damper motor. Damper blades ride in Delrin bearings. Cold deck damper has built in bypass. Interior of damper box is lined with 1/2" thick neoprene coated fiberglass insulation. Supply duct connections can be made in several different locations. See dimension drawings. Flanges are provided for hot and cold deck duct connections.

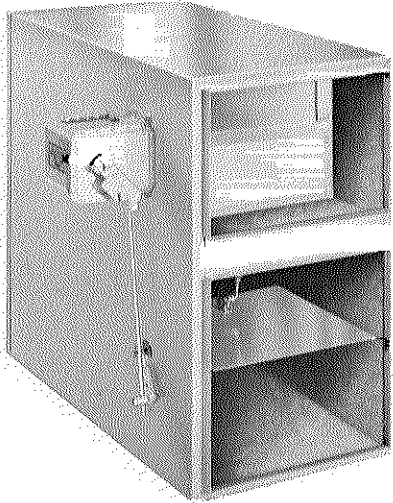

### SPECIFICATIONS

Model No.	Air Volume Range (cfm)	Resistance (in. w.g.)		Approx. Shipping Weight (lbs)
		Min (cfm)	Max (cfm)	
ZD1-250	150-250	.10	.22	36
ZD2-250	150-250	.10	.22	38
ZD1-400	250-400	.10	.22	39
ZD2-400	250-400	.10	.22	41
ZD1-700	400-700	.07	.21	42
ZD2-700	400-700	.07	.21	44
ZD1-1000	700-1000	.11	.22	49
ZD2-1000	700-1000	.11	.22	51
ZD1-1500	1000-1500	.09	.21	64
ZD2-1500	1000-1500	.09	.21	66
ZD1-2200	1500-2200	.11	.24	79
ZD2-2200	1500-2200	.11	.24	81

### DIMENSIONS (in.)

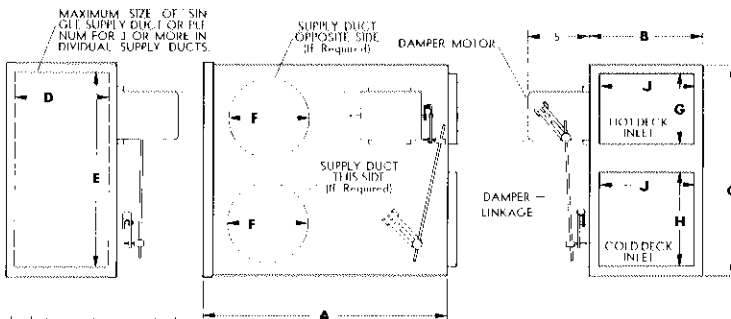

Supply duct connections can also be made at top or bottom of damper box.

### ALTERNATE MOTOR POSITION

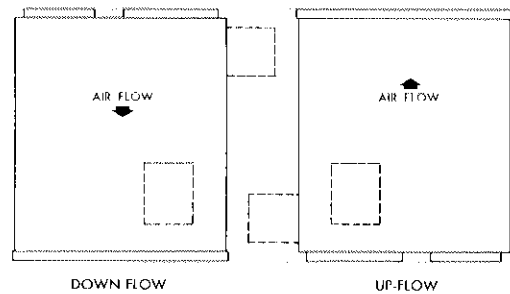

### AIR PATTERN DETAIL

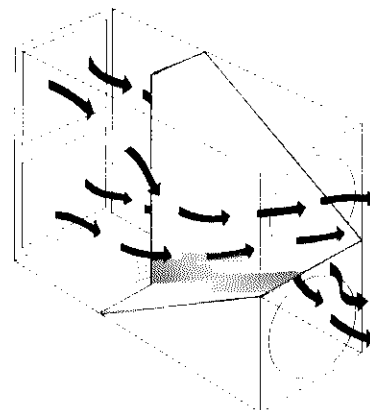

Model No.	A	B	C	D	E	F	G	H	J
ZD1 & ZD2-250	16	8 1/4	15 3/4	7	14 1/2	6	5 1/2	7	7
ZD1 & ZD2-400	20	9 1/4	17 1/4	8	16	7	6	8	8
ZD1 & ZD2-700	24	11 1/4	20 3/4	10	18	9	7 1/2	10	10
ZD1 & ZD2-1000	27 1/2	13 1/4	23 3/4	12	22	10	8 1/2	12	12
ZD1 & ZD2-1500	31 1/2	15 1/4	27 1/4	14	26	12	10	14	14
ZD1 & ZD2-2200	36	17 1/4	31 1/4	16	30	14	12	16	16

# SCHEMATIC REFRIGERANT LINE ARRANGEMENT

**DMS1-275 WITH EVMS1-95V & HS6-953V or  
DMS1-275 WITH EVMS1-135V & HS6-953V or  
DMS1-275 WITH EVMS1-135V & HS6-1353V**

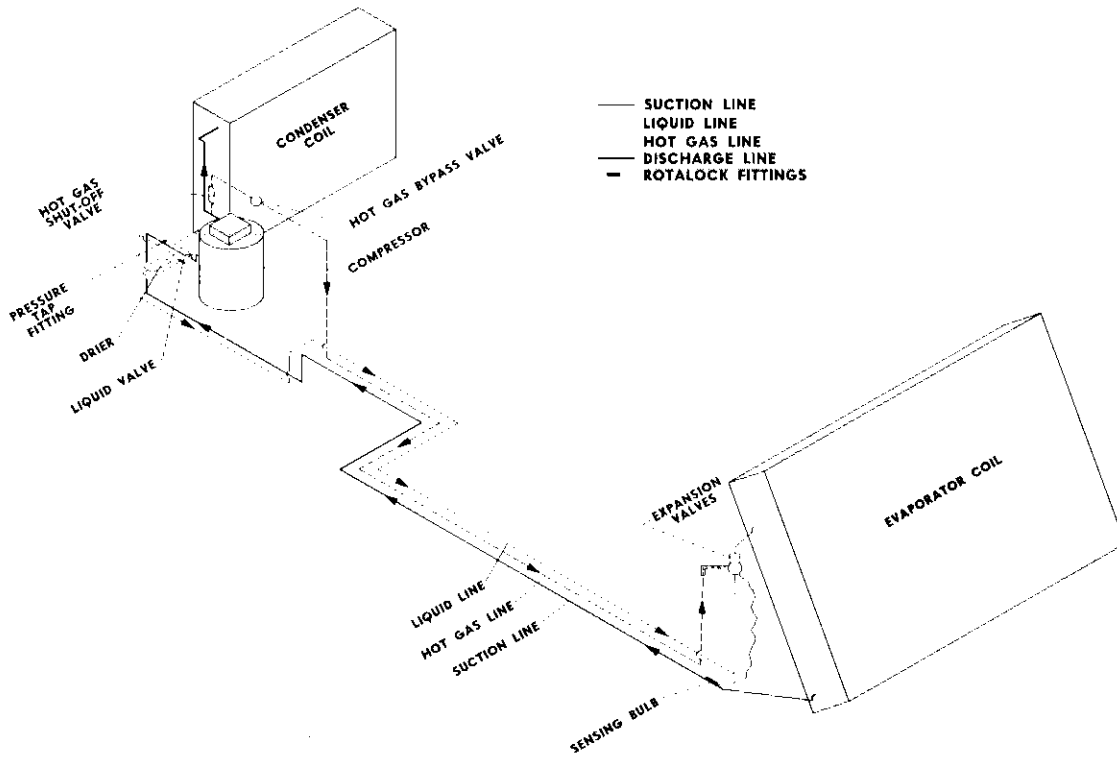

**DMS1-275 WITH EVMS1-185V & HSM1-1853V or  
DMS1-275 WITH EVMS1-275V & HSM1-1853V or  
DMS1-275 WITH EVMS1-275V & HSM1-2753V-1**

