

HONEYWELL SINGLE ZONE SOLID STATE CONTROL SYSTEM USED ON CHA11, CHP11 AND GCS11 UNITS

I - INTRODUCTION

The "Honeywell" Single Zone Solid State Control System is being incorporated into the CHA11, CHP11 and GCS11 lines of single zone equipment. This is an expansion to the "Lennox Electronic Energy Saving Systems". Like the "Lodapt" control system used in DMS4, RVZ1 and DSS1, the Honeywell system is demand oriented to match unit operation and energy consumption accurately to the actual load requirements.

II - SYSTEM OPERATION

The basic control system consists of the room controller, a discharge sensor and the logic panel which is the heart of the system. See Figure 1. If the unit includes the power saver option, an additional motor is included. The room controller field installs in the conditioned space. The discharge sensor, logic panel and power saver motor are located in the unit.

A - Basic Operation

Both the room controller and the discharge sensor contain

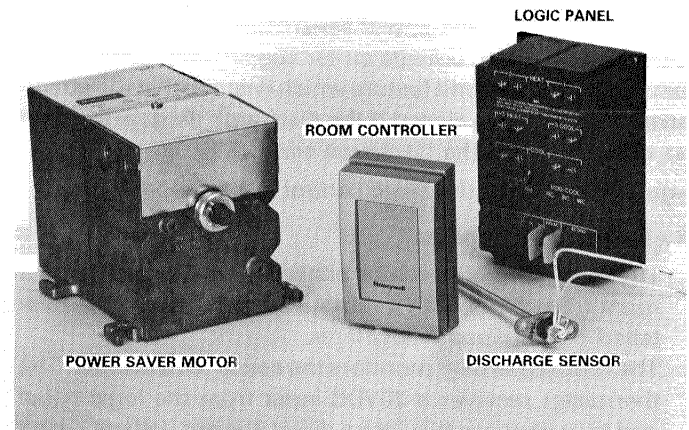

FIGURE 1

thermistors which change electrical resistance in response to a temperature change. This electrical resistance is directly proportional to the actual temperature at the thermistor. The field installed room controller monitors the space tempera-

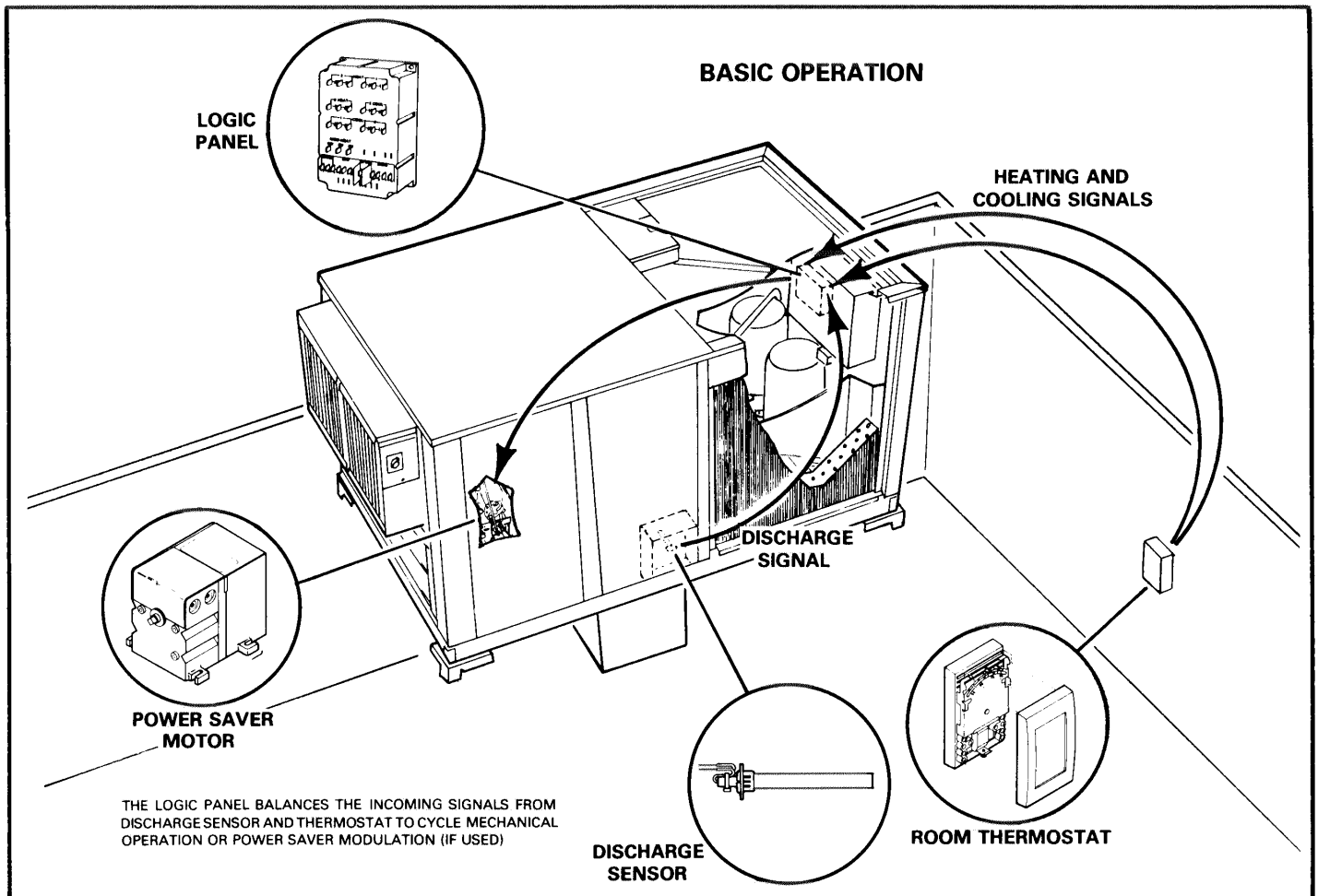

FIGURE 2

ture. The discharge sensor, located in the unit discharge air stream, monitors the machine's output.

In simple terminology, the Honeywell control system compares the space demand to the machine's output and then logically cycles the unit to satisfy the demand with minimum energy consumption.

If the unit includes the power saver option, the control system utilizes suitable outside air for cooling. The control system includes a low limit feature which ensures that the power saver will modulate closed if the discharge air gets too cold (as determined by the discharge sensor).

Figure 2 illustrates the basic control system operation.

B - Room Controller

- 1 - The room controller can be either a room thermostat or a room transmitter with a remote sensor (thermistor). Detailed descriptions follow later.
- 2 - The room controller monitors the space temperature. The thermistor receives a 20VDC input from the logic panel and then changes this into a direct current voltage which is directly equivalent to the temperature deviation from room controller's heating or cooling setpoints. The thermostat or transmitter sends out either a heating or cooling DC ramp signal back to the logic panel.
- 3 - The heating and cooling ramp signals both increase approximately 2.5 VDC for every 1°F from setpoint.

C - Discharge Sensor

- 1 - Figure 3 shows the discharge sensor location in a typical CHP11 unit.
- 2 - The discharge sensor adjusts the heating or cooling ramp signal in anticipation of the effect the supply air will have on room temperature. It reduces undershoot or overshoot. The discharge sensor has a 25 to 1 authority ratio. A 25°F temperature rise at the discharge sensor is equivalent to a 1°F rise in temperature at the room controller.
- 3 - The logic panel uses the discharge sensor as a positive modulating low limit for the optional power saver. If the

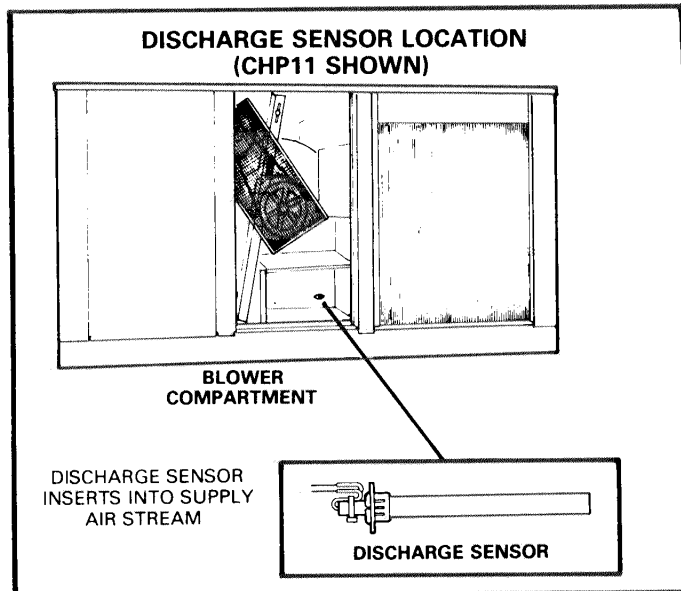

FIGURE 3

discharge air temperature drops below 62°F, the outdoor air dampers begin to close. At 50°F the dampers will be in minimum position.

D - Logic Panel

- 1 - The logic panel responds to the heating or cooling ramp signals to cycle the equipment through progressive switching.
- 2 - The electric heat, gas heat and heat pump options cycle through the "H" contacts, while the hot water option modulates in direct response to the heating ramp signal.
- 3 - The mechanical cooling cycles through the "C" contacts, while the power saver option modulates in direct response to the cooling ramp signal.
- 4 - Different logic panels are used for the necessary switching as determined by the application. Figure 4 identifies all the switches and terminals used on logic panels. All logic panels perform to the heating and cooling ramp charts.

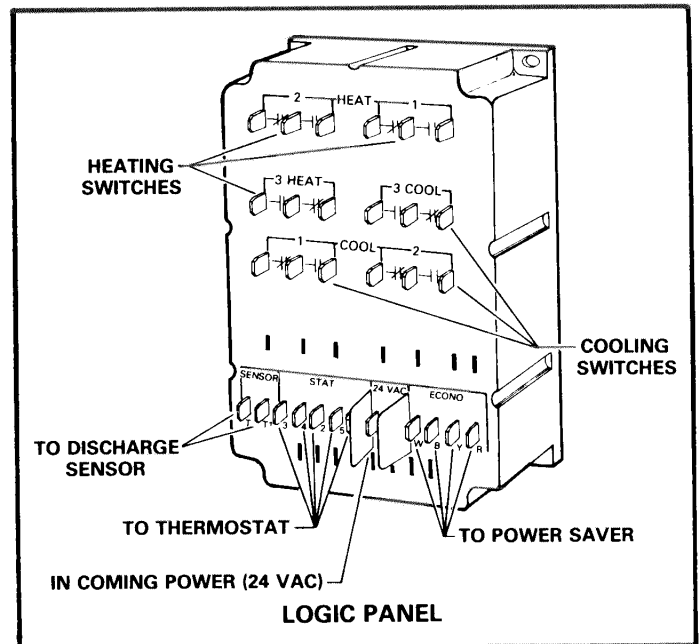

FIGURE 4

E - Heating And Cooling Ramp Charts

- 1 - As previously noted, the heating and cooling ramp signals increase approximately 2.5 VDC for each 1°F deviation of space temperature from room controller setpoint. The discharge sensor adjusts the heating or cooling ramp signal in anticipation of the effects of the supply air temperature. The discharge sensor has a 25 to 1 authority ratio.
- 2 - The heating or cooling ramp signal is transmitted from the room controller to the logic panel. The logic panel cycles the equipment through progressive switching. The correlation between the ramp signals and unit sequence of operation is illustrated in chart form. See Figure 5.
- 3 - The actual heating ramp signal can be read with a DC voltmeter between terminals 1 and 5 at either the room controller or at the logic panel. This heating signal ranges between 1 - 16 VDC as generated by the heating demand and the effects of discharge temperature. The signal will

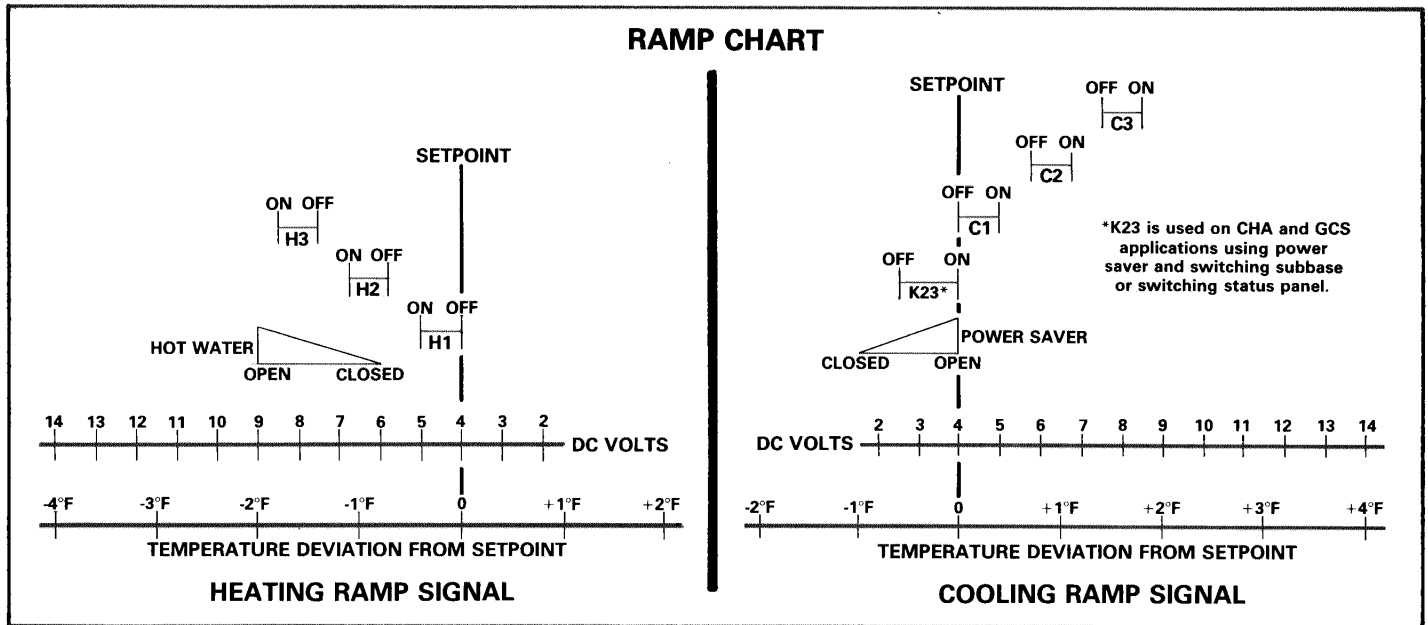

FIGURE 5

be 4 VDC or lower at no load and increase approximately 2.5 VDC with each 1°F drop below the heat lever setpoint.

- 4 - The "H" contacts progressively make to cycle the gas, electric heat or heat pump options. As the heating demand is satisfied and the space temperature approaches setpoint, the switches cycle off in reverse order.
- 5 - The cooling ramp signal can be read with a DC voltmeter between terminals 1 and 4 at either the room controller or at the logic panel. The cooling signal ranges between 1 - 16 VDC as generated by the cooling demand and the effects of discharge temperature. Between the 1.5 and 4 VDC no load condition on the cooling ramp, the logic panel energizes the power saver motor (if used) to modulate dampers open depending on discharge temperature, enthalpy control and blower operation.
- 6 - The "C" contacts progressively make to cycle the mechanical cooling. As the cooling demand is satisfied and the space temperature approaches setpoint, the switches cycle off in reverse order.

III - CONTROL OPTION CHART

The room controller must be ordered separately. Lennox offers a variety of performance options and accessories when selecting the room controller. Figure 6 illustrates the compatible control options and lists the corresponding ordering numbers.

- 1 - The room thermostat includes the thermistor and heating-cooling setpoint levers.
- 2 - The room transmitter contains only the heating-cooling setpoint levers and installs separately from the sensor (transmitter). This remote sensor is available in two styles; one for duct mounting and one for wall mounting. The wall sensor is used with intermittent blower operation.

NOTE - Both the thermostat and transmitter are sent with a standard non-switching subbase. With this subbase, the thermostat or transmitter automatically switches from heating-cooling modes and blower operation is continuous.

- 3 - The optional switching subbase allows a choice of intermittent blower operation and the selection of the system operating mode. The switching subbase installs with either the thermostat or transmitter.

A separate switching subbase is used for heat pumps. If a subbase is used in conjunction with a CHA11 or GCS11 unit that has Power Saver, a voltage control relay (K23) is also required.

- 4 - The optional SP11 status panel accessory allows remote monitoring of system operation. On electric heat applications, a current sensing relay kit (K20) must be field installed. On hot water applications, a hot water proving relay kit (K24) must be field installed. A filter switch kit must also be ordered to utilize the dirty filter indication.
- 5 - The optional SSP11 switching status panel combines the switching subbase and status panel functions. The SSP11 also includes a night setback override feature which bypasses the unit's night setback function when used. The same SP11 kit options apply to the SSP11. If the SSP11 is installed with a CHA11 or GCS11 unit that has a Power Saver, the voltage control relay (K23) must be used.

IV - ROOM CONTROLLER OPTIONS AND ACCESSORIES

A - Room Thermostat (25C5201)

- 1 - Temperature changes in the space are measured by a thermistor. As the room temperature changes, the resistance of the thermistor changes. The logic panel provides the 20 VDC power to the thermostat.

CONTROL OPTION CHART

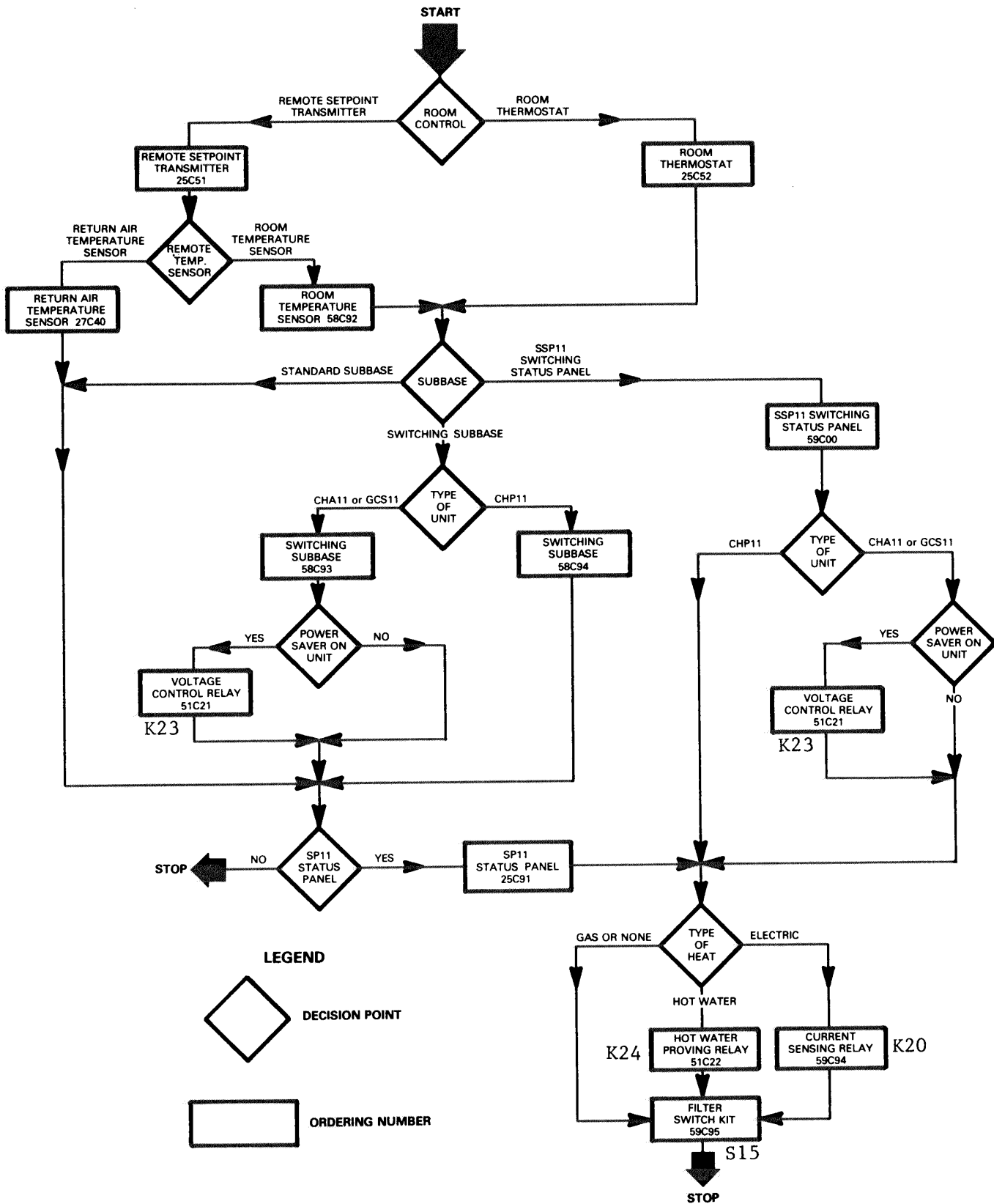

FIGURE 6

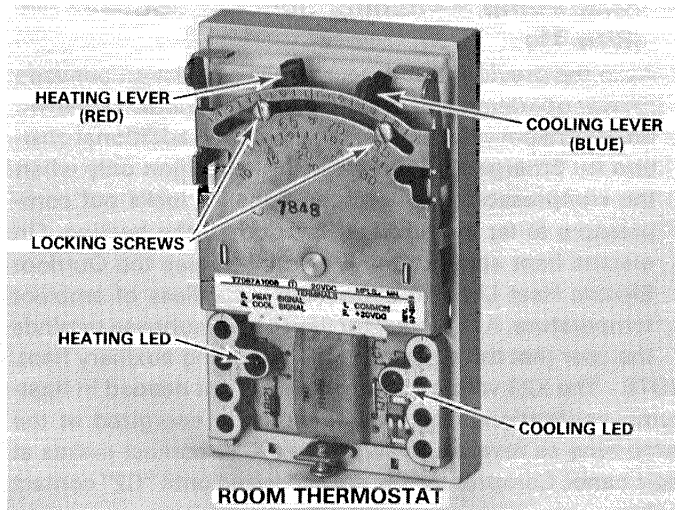

FIGURE 7

- 2 - Thermostat output consists of two voltage ramp signals, one for heating and one for cooling. A change in the thermistor resistance causes the thermostat to generate a DC ramp signal which is proportional to the temperature deviation from setpoint. The discharge sensor adjusts the signal in anticipation of the effects of discharge temperature. The heating or cooling ramp signal is sent to the logic panel which energizes the heating or cooling stages.
- 3 - Load reactive time delays are built into the thermostat to provide system stability and to provide a time delay between restart of stages after a power failure. The length of time delay varies with the temperature difference between the thermistor sensor and the thermostat setpoint. As the difference increases, the delay becomes shorter. As the difference decreases, the delay becomes longer.
- 4 - Setpoint adjustment range is from 55° to 85°F. The thermostat has individually adjustable heating and cooling setpoints. See Figure 7. The temperature gap between the setpoint levers represents the "no load" band where unit does not operate. With levers together the no load band is 3°F. Adjustment of no load is done by spreading set point levers apart. The maximum band is 30°F.
- 5 - Diagnostic indicator lights, located under cover, allow fast visual checkout of thermostat output. See Figure 7. Two LED's (heat and cool) brighten in response to increased heating and cooling demand.
- 6 - A non-switching subbase is sent with the thermostat. When installed together, the thermostat automatically changes between heating and cooling. It also provides continuous blower operation, except during periods of night setback (if used).
- 7 - The room thermostat mounts on a standard 2 x 4 inch handy box as shown in Figure 8. Locate thermostat approximately 5 feet above floor in an area with good air circulation at average temperature.

If an optional switching subbase is used, identify the 2 low voltage AC wires at thermostat. These wires connect to fan switch option and wire to terminals 9 and 10 of subbase. **Do not interconnect AC and DC wires.**

Run separate harnesses for AC and DC currents. AC voltage interferes with DC signals.

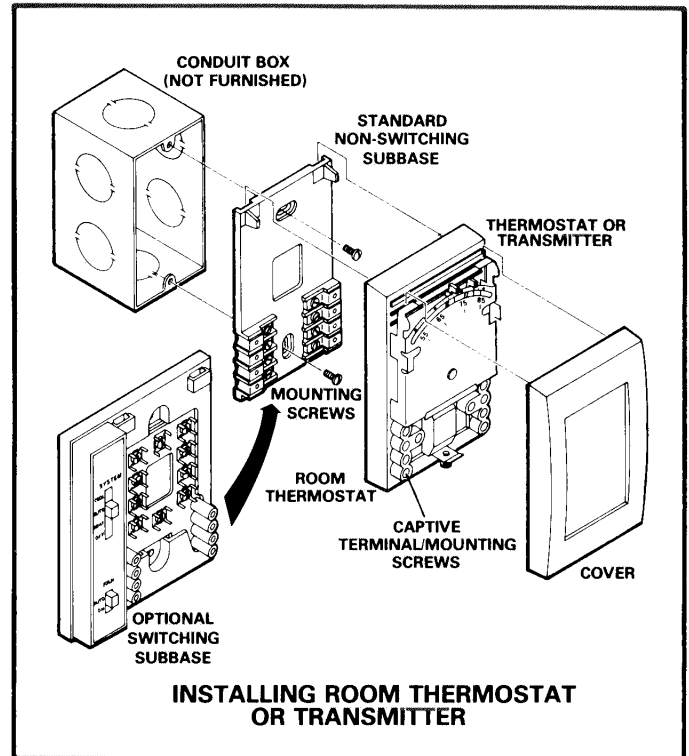

FIGURE 8

B - Transmitter (25C5101) And Remote Duct Sensor (27C4001) Or Remote Wall Sensor (58C9201)

- 1 - The transmitter functions the same as the thermostat, except that it only contains the heating-cooling set point levers and must be used with a remote sensor (thermistor). Figure 9 shows transmitter with a remote duct sensor.
- 2 - The transmitter and remote sensor install in separate locations. Either a remote duct sensor or a remote wall sensor may be used. The wall sensor is used with intermittent blower operation. The transmitter can be located

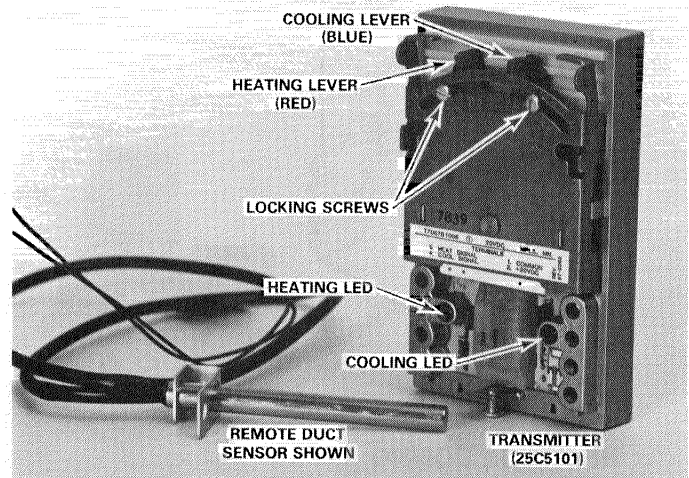

FIGURE 9

at a central station where the set point settings will not be subject to unauthorized adjustment.

- 3 - The transmitter also mounts on a 2 x 4 inch handy box as shown in Figure 8. If an optional switching subbase is used, identify the 2 low voltage AC wires at transmitter. These wires connect to fan switch option and wire to subbase terminals 9 and 10.

On CHA11 and CHP11 units, run 2 DC wires between the remote sensor and the transmitter. On GCS11 units, run the 2 DC wires from the remote sensor to the low voltage junction box.

Run separate harnesses for AC and DC currents. AC voltage interferes with DC signals.

C - Heating/Cooling Switching Subbase 58C9301 And K23 Voltage Control Relay 51C2101 (Figure 10)

- 1 - The switching subbase allows a selection between blower operation and system operating mode. Simply substitute this subbase in place of the one sent with thermostat or transmitter.
- 2 - If the application includes power saver, a K23 voltage controlled relay must be field installed. When the subbase is set at "Auto", this relay picks up the blower for power saver operation. The blower comes on at 4 VDC (cooling ramp signal) and cycles off at 2.5 - 3 VDC.
- 3 - The fan switch is manually set to desired position:
 AUTO - Blower operates to demand.
 ON - Blower operates continuously.
- 4 - The system switch can be manually positioned for:
 HEAT - Heat operation only.
 COOL - Cooling operation only.
 AUTO - System automatically provides heating or cooling on demand.
 OFF - System off.

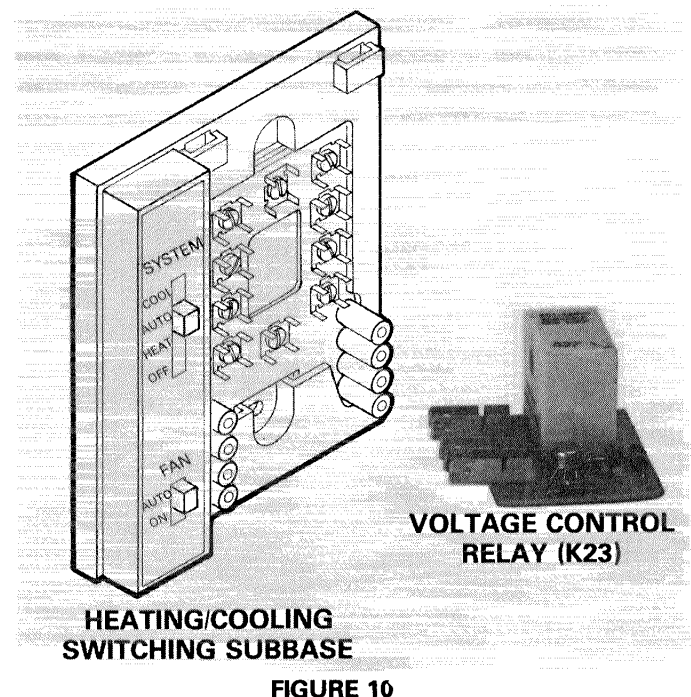

D - Heat Pump Switching Subbase 58C9401 (Figure 11)

- 1 - As in the previous subbase, there is a selection between blower operation and system operating mode. However, on the system selection switch there is an additional position for Emergency Heat. Select this position only when the compressors are not operational. It locks out compressors to let the auxiliary heat do all the heating. On electric heat applications it also by-passes the Outdoor Electric Heat Limit to allow heat regardless of ambient temperature. A red indicator light on the subbase reminds the user that the system is only providing auxiliary heat.
 NOTE - The K23 voltage control relay is not needed in heat-pump applications. The blower motor is energized at the same time as reversing valve when "C1" contact makes at logic panel. Compressor 1 is not energized until "C2" contact makes.
- 2 - The fan switch is manually set to desired position:
 AUTO - Blower operates to demand.
 ON - Blower operates continuously.
 OFF - System off.
- 3 - The system switch can be manually positioned for:
 HEAT - Heat operation only.
 COOL - Cooling operation only.
 AUTO - System automatically provides heating or cooling on demand.
 EM. HEAT - Shuts off compressor(s) and cycles auxiliary heat.

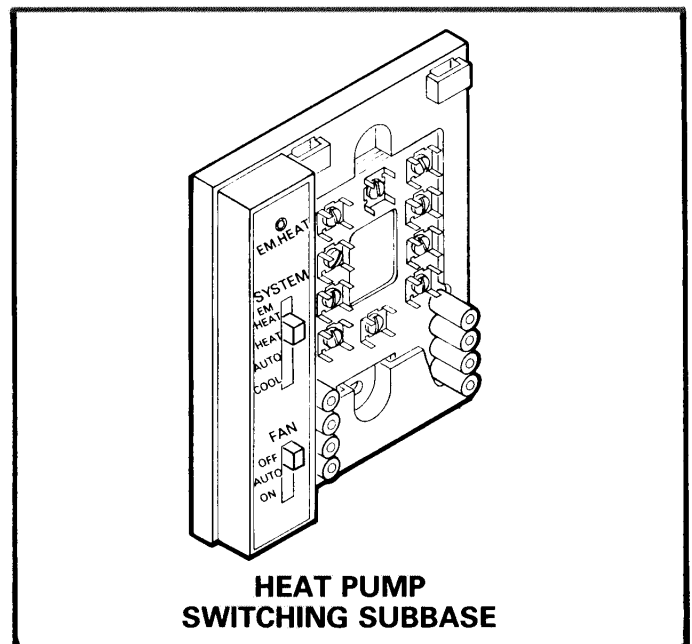

FIGURE 11

E - Status Panel Options

- 1 - The status panel allows remote monitoring of system operation. Two types of panels are available. The SP11 provides system readout only. The SSP11 switching status panel combines the switching subbase and status panel functions together. In addition, the SSP11 has a night setback override. Figures 12 and 13 show both models.

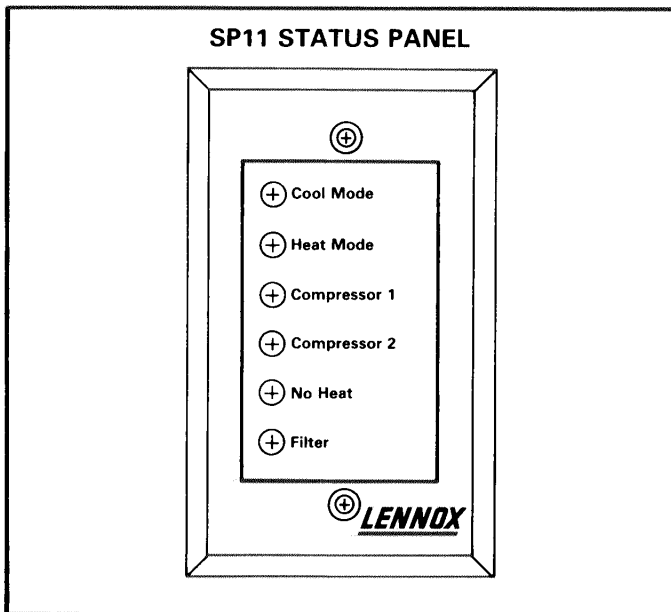

FIGURE 12

- 2 - The "Cool Mode" LED is green when lit. It indicates Power Saver operation when unit is so equipped. Otherwise, the LED indicates DX cooling operation.
- 3 - The "Heat Mode" LED lights green during heating operation. The system switch on the SSP11 switching status panel includes an emergency heat position. This function is only applicable to the CHP11. This LED switches red whenever the SSP11 system switch is placed to Emergency Heat. To avoid confusion on CHA11 and GCS11 units, cut out the yellow wire at SSP11. This prevents light from changing to red.
- 4 - The "Compressor 1" and "Compressor 2" LED's are green when the respective compressors are running. Either light will turn red if a compressor safety switch opens during a compressor demand.
- 5 - The "No Heat" LED lights red on a loss of auxiliary heat. When applied to an ECH11 heater, a field installed current sensing relay (K20) detects current flow to the first element. On hot water applications, a sensing circuit consisting of an electronic relay (K24), a sensing thermostat (S21) and a hot water delay (DL6) detects a no heat situation. On GCS11 units, a circuit consisting of a no heat relay and a no heat delay within the GCS11 detects a no heat situation.
- 6 - The "System" switch on the SSP11 has five positions to indicate the following modes.
 - OFF - System off.
 - HEAT - Heating only.
 - AUTO - System automatically provides heating or cooling on demand.
 - COOL - Cooling only.
 - EMERGENCY HEAT - Heat pump only.
- 7 - The "Fan" switch on the SSP11 has two positions to indicate the following modes:
 - AUTO - Blower cycles with demand.
 - ON - Blower runs continuously.

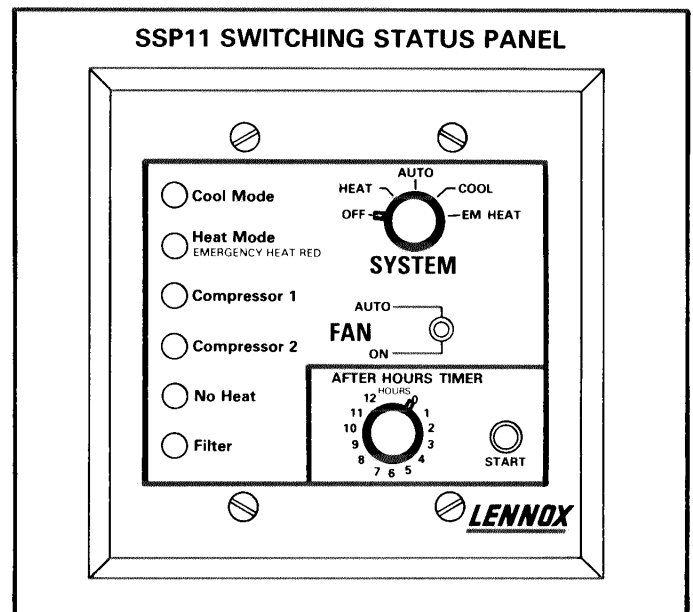

FIGURE 13

- 8 - The "After Hours" timer on the SSP11 provides an override of night setback from 0 to 12 hours. A push button switch initiates the time period.

V - POWER SAVER OPTION

A - Operation

The power saver consists of outdoor and return dampers which open and close in reverse relationship to each other. The power saver motor drives the dampers. Figure 14 shows the power saver option in a CHP11.

The logic panel energizes the power saver motor to modulate the outdoor dampers. The power saver is held at minimum position unless a call for cooling exists and the outdoor air is

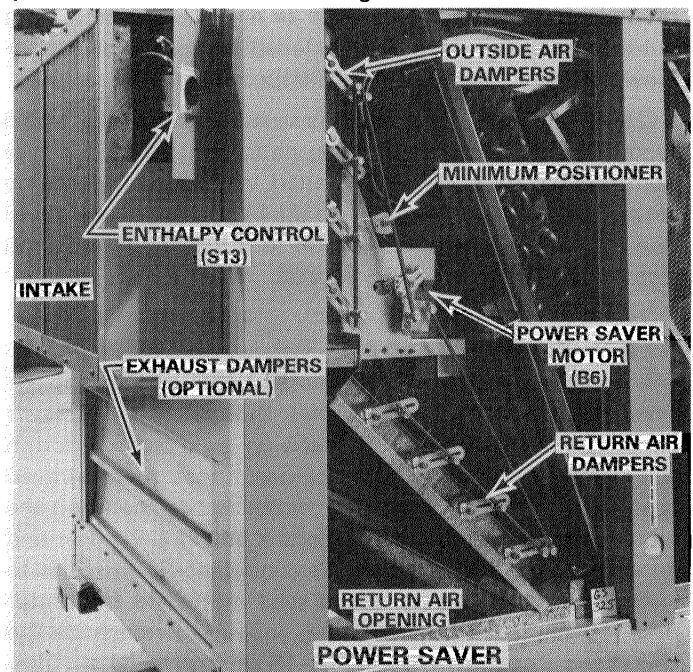

FIGURE 14

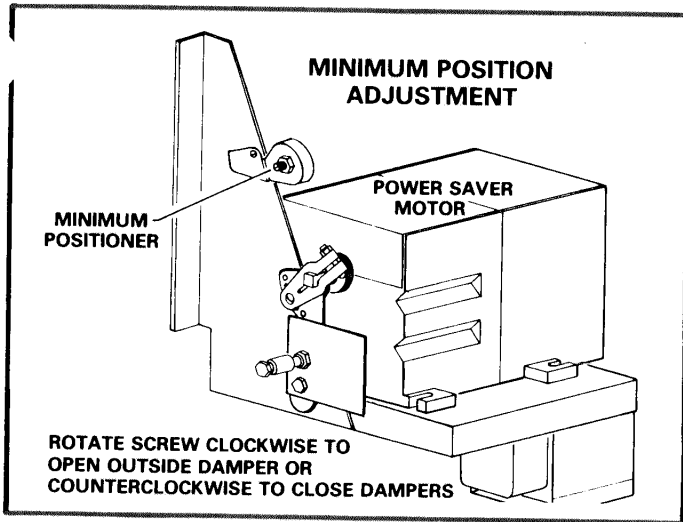

FIGURE 16

D - Enthalpy Control

The enthalpy control senses the heat content of the air. If heat content rises above control setpoint, the power saver dampers drive to minimum position. The recommended set point is "A". If power saver is allowing air which is too warm or humid to enter system, set control to a lower setpoint. Figure 17 shows the enthalpy control, mounting plate and a chart listing the control range at "A" and "D" settings.

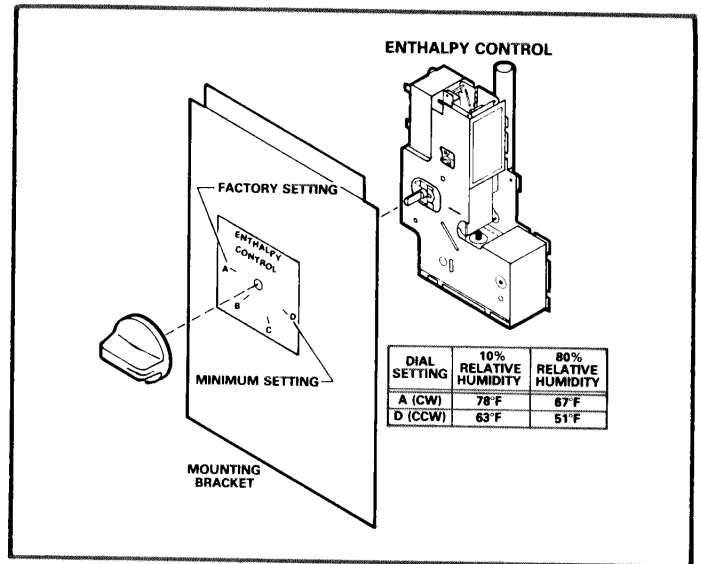

FIGURE 17

Ideally the system would use power saver under favorable conditions, but during high humidity it would cycle the blower and outside air dampers to compressor demand. This can be accomplished with the use of a switching subbase or switching status panel and the field installation of a special relay. Refer to unit service manual for hook-up and explanation of operating sequence.

E - Humid Climate Option

In very humid regions normal power saver operation creates a humidity control problem. During periods of excessive humidity, the outside dampers should be held closed and blower motor de-energized unless there is compressor operation. This assures that damp air will not be drawn into the building without being dehumidified at the evaporator. It also prevents conditioned air from absorbing moisture from a wet evaporator at the end of a compressor cycle.

VI - NIGHT SETBACK OPTION

The "Honeywell" control system may be interfaced with a time clock (16C1701) to put the unit into the unoccupied mode (night setback). Time clock settings automatically activate and deactivate unit controls affecting heating & cooling setpoints, power saver and blower operation.

The outdoor air dampers are held closed during heating setback to prevent heating unneeded ventilation air.

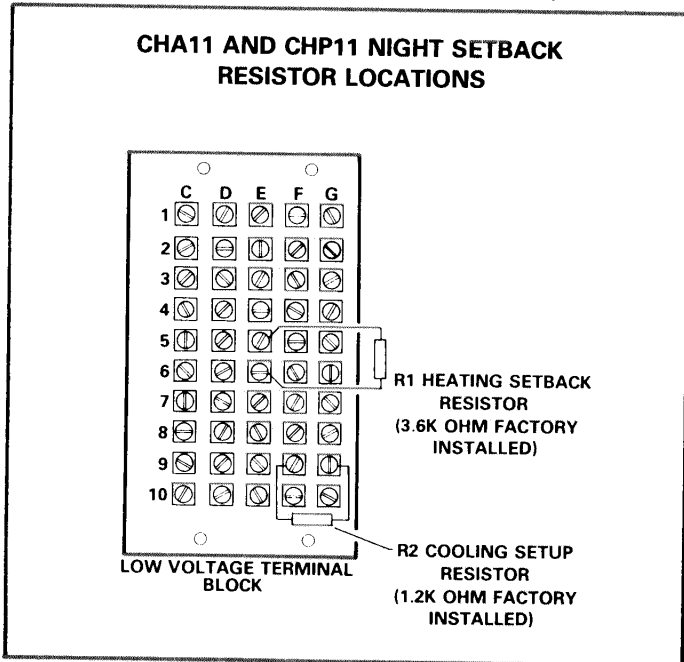

FIGURE 18

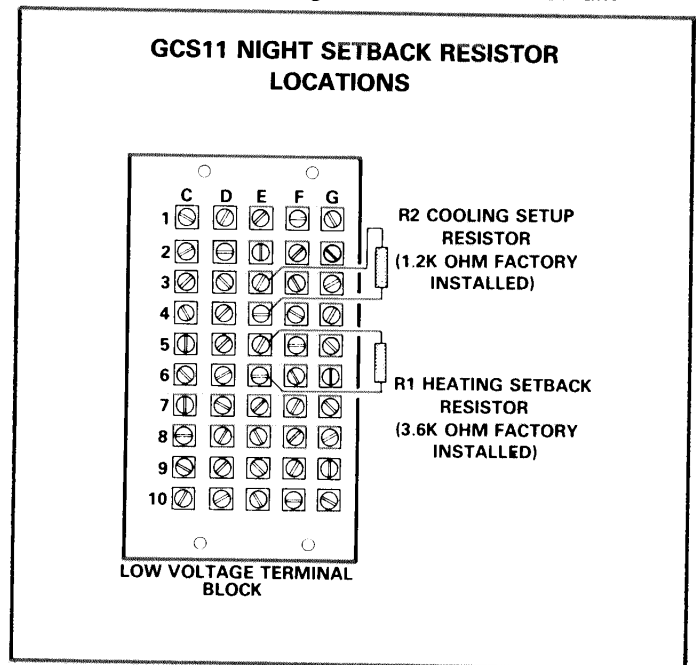

FIGURE 19

The outdoor dampers are held closed during cooling setup. The blower cycles with demand from "C1" on logic panel. Mechanical cooling is used to satisfy the demand. If cooling lockout is chosen, the equipment is shut down and the outdoor air dampers are held closed.

The degree of heating setback or cooling setup is determined by separate resistors at the low voltage terminal block. Units are sent with a 3.6K ohm heating resistor which corresponds to a 10°F heating setback and a 1.2K ohm cooling resistor for cooling lockout. Figures 18 and 19 show the resistor locations for CHA11/CHP11 and GCS11 units.

A field selectable amount of heating setback or cooling setup is available. If another setting is desired for heating setback or cooling setup, substitute for the correct size resistor shown in Table 1.

TABLE 1

°F	Night Setback (R1)	Cool Setup (R2)
5	7.5K	20K
7	----	18K
9	----	16K
10	3.6K*	15K
13	----	13K
15	2K	12K
Cool Lockout	----	1.2K**

*This resistor is factory installed for heating. There is a 7.5K resistor taped to side of low voltage junction box.

**This resistor is factory installed for cooling. Establishing a cooling setup value with a resistor of less than 1.2K ohm resistance will limit the maximum heat setback value to 12°F.

NOTE - Establishing a cooling setup value of less than 1.2K will limit the maximum heat setback value to 12°F.

VII - OUTDOOR DAMPER POSITIONS (Figure 20)

1 - Minimum Position

- Heating
- Cooling demand and outside air temperature above enthalpy control setting.
- Cooling demand with discharge temperature below 50°F.

2 - Open position

- Cooling demand and outside air temperature below enthalpy control setting with:
- Discharge temperatures above 62°F.

3 - Modulating Position

- Initial cooling demand (between 1.5 and 4 VDC cooling ramp signal).
- Discharge temperatures between 62°F and 50°F.

4 - Closed Position

- Power failure.
- During night setback conditions.
- During the blower off cycle when using intermittent blower operation.

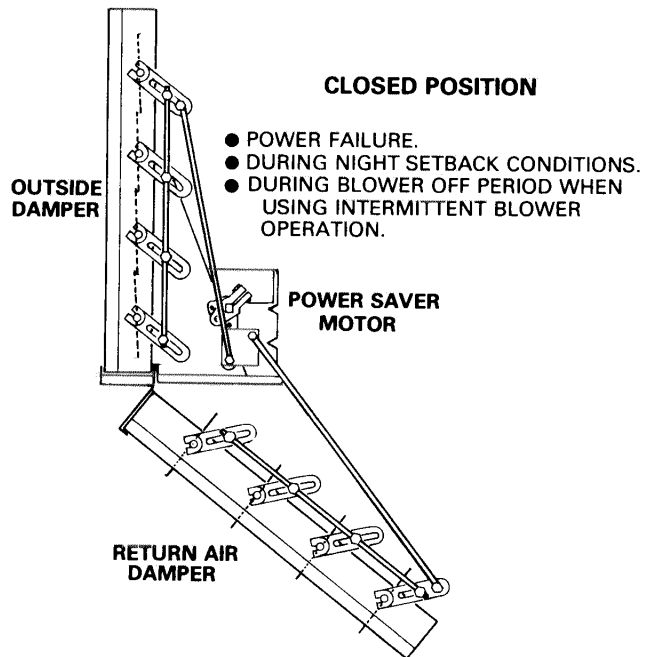
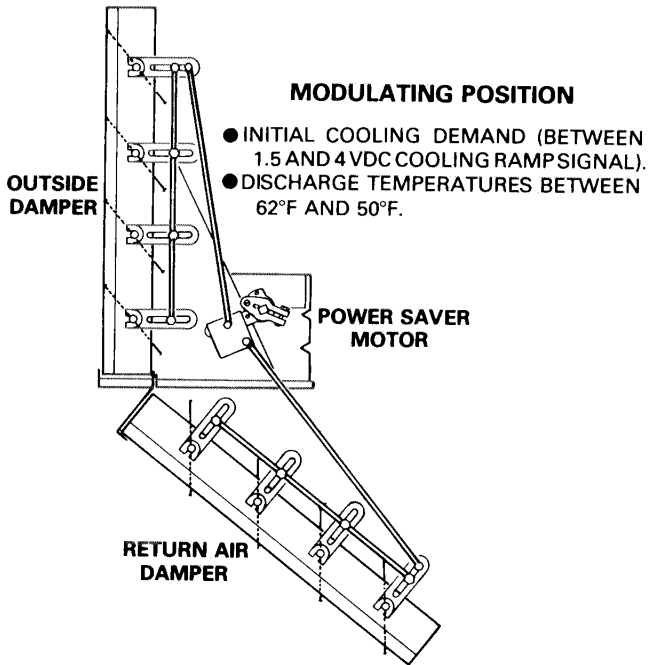
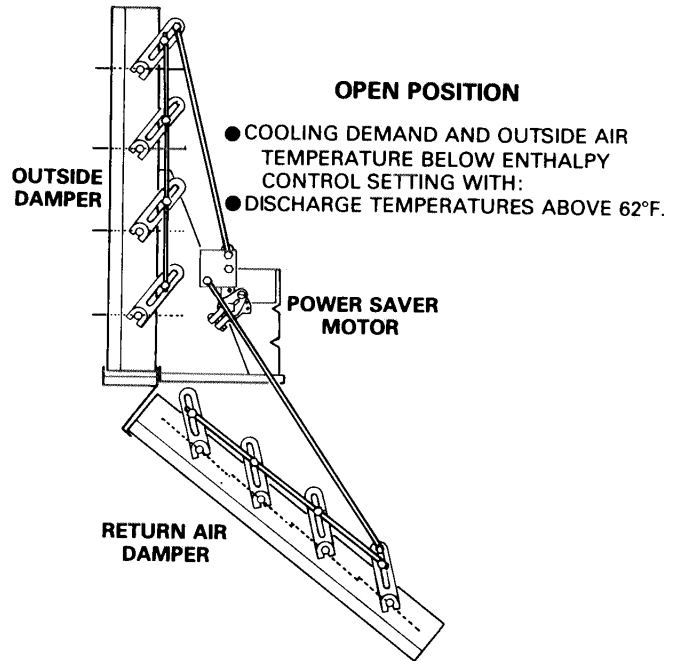
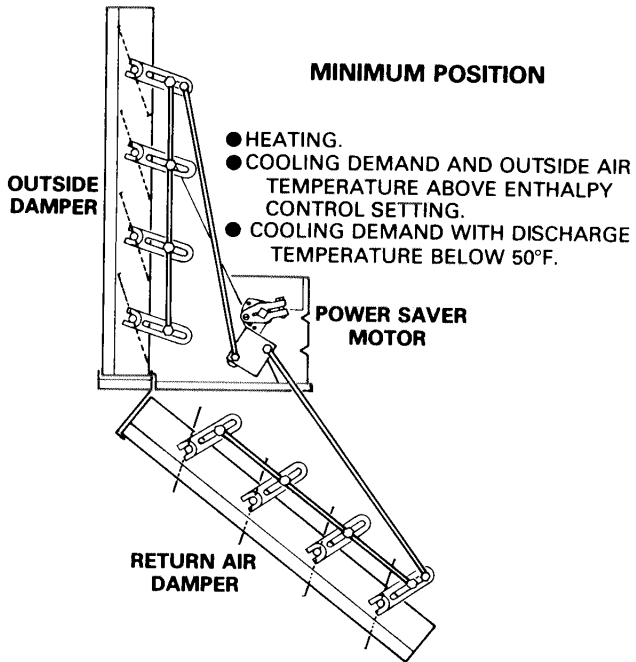

DAMPER POSITIONS

FIGURE 20

VIII - TROUBLESHOOTING

Before checking out this solid state control system, make sure that all other components affecting system operation are working properly. Refer to the troubleshooting section in the unit service manual.

Be extremely careful when making checks on a solid state control system. **Do not mix the different voltages.** It is generally fatal to the control and the only remedy is to replace the burned out components.

A - Preliminary Checks

The following checkout procedure isolates problems to the electronic control system or to the unit itself.

- 1 - If the control system places the machine into full heating without a demand, check the discharge sensor. If a discharge sensor leg is open, the logic panel will cycle the unit into full heating.
- 2 - Make sure power is available at logic panel and that the time clock (if used) is in the occupied mode. Check that compressor ambient lockout and any limit controls are closed. If optional switching subbase is used, set system and fan switches to "Auto".
- 3 - Remove cover from room thermostat; note red diagnostic light emitting diodes (LED's).
- 4 - Move thermostat cooling setpoint (blue lever) below room temperature to call for cooling. Cooling LED on the right side of the sensor should begin to glow. Then observe cooling equipment. If the enthalpy of the outdoor air is below the setpoint, the power saver dampers will modulate open as the first stage of cooling. The low limit feature within the logic panel will modulate dampers closed if discharge temperature drops below 62°F. The dampers will drive to minimum position as the discharge temperature drops to 50°F.

If the mechanical cooling does not come on, jumper cooling stages at logic panel in equipment. If the compressors do not come on, the problem is not with the logic panel.

- 5 - Move thermostat cooling set point above room temperature. Cooling equipment should cycle off and cooling LED intensity should decrease to a faint glow or go off completely. Power saver dampers should drive to minimum position or closed if blower is intermittent.
- 6 - Move thermostat heating set point (red lever) above room temperature. Heating LED on the left side of the sensor should begin to glow. Heating equipment should cycle on. If heating equipment does not cycle on, jumper heating stages at logic panel in equipment. If heating still does not come on, the problem is not with the logic panel.
- 7 - Move heating set point below room temperature. Heating stages should cycle off, and heating LED intensity should decrease to a faint glow or go off completely. Return heating and cooling set point to desired setting, lock set points as desired. Return subbase switches, if used, to desired positions.

- 8 - If the electronic control system is not operating properly, perform the following component checks.

B - Room Thermostat Or Transmitter

- 1 - Use a DC voltmeter set for 20V scale.
- 2 - Check for power to the room sensor. Connect negative (-) lead to terminal 1 and the positive (+) lead to terminal 2. Meter should read 20 VDC. See Figure 21.
- 3 - Connect the negative (-) lead to terminal 1 and the positive (+) lead to terminal 4.
- 4 - Slowly move the cooling lever below room temperature to simulate a call for cooling. The meter reading should gradually increase to about 16 VDC.
- 5 - Move the cooling lever above room temperature. The meter should drop to less than 2 VDC.
- 6 - Remove the (+) meter lead from terminal 4 and connect it to terminal 5.
- 7 - Slowly move the heating lever above room temperature to simulate a call for heating. The meter reading should gradually increase to about 16 VDC.
- 8 - Move the heating lever below room temperature. The meter should drop to less than 2 VDC.

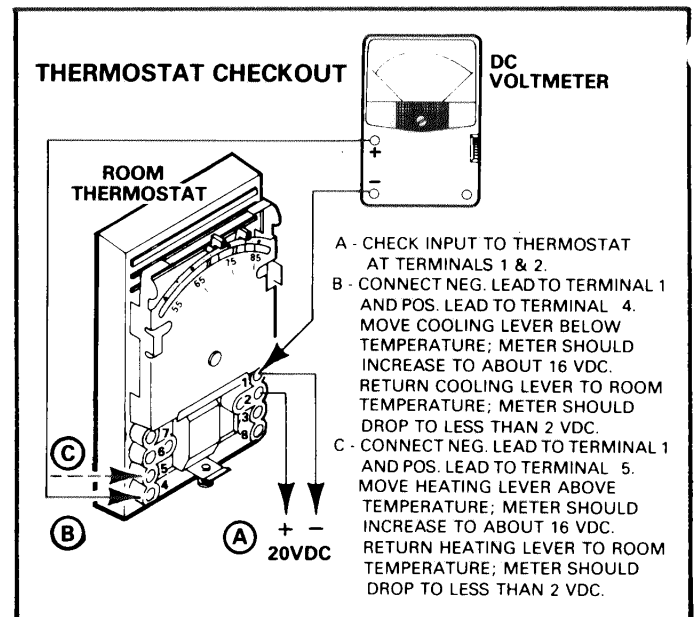

FIGURE 21

C - Discharge Sensor

- 1 - If the discharge sensor thermistor has opened or if a discharge sensor leg is disconnected, the logic panel will place the machine into full heating.
- 2 - Use an ohm meter set to scale R x 100.
- 3 - Disconnect the lead from sensor terminal T1 on logic panel. Connect one lead to terminal T and the other meter lead to loose lead wire from the sensor. See Figure 22. Record temperature at discharge sensor.

- 4 - Meter reading depends on the temperature at the sensor. Discharge sensor resistance should be between 1500 to 4500 ohms. For resistance readings at different temperatures, see Figure 23.

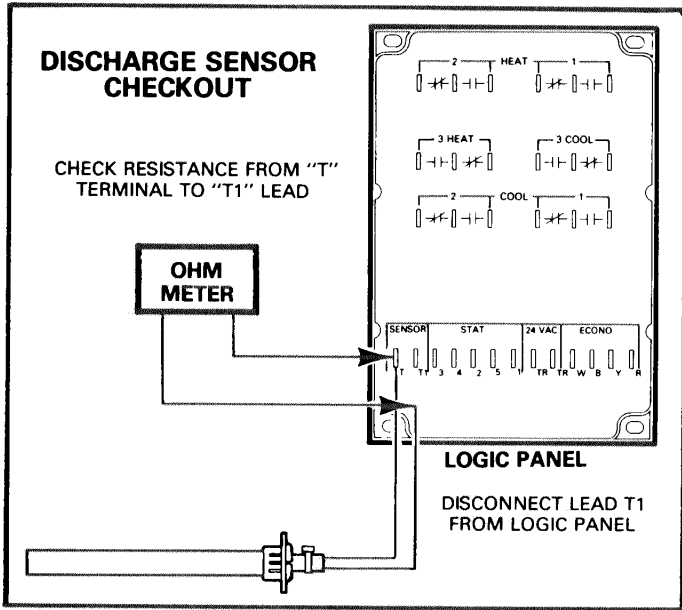

FIGURE 22

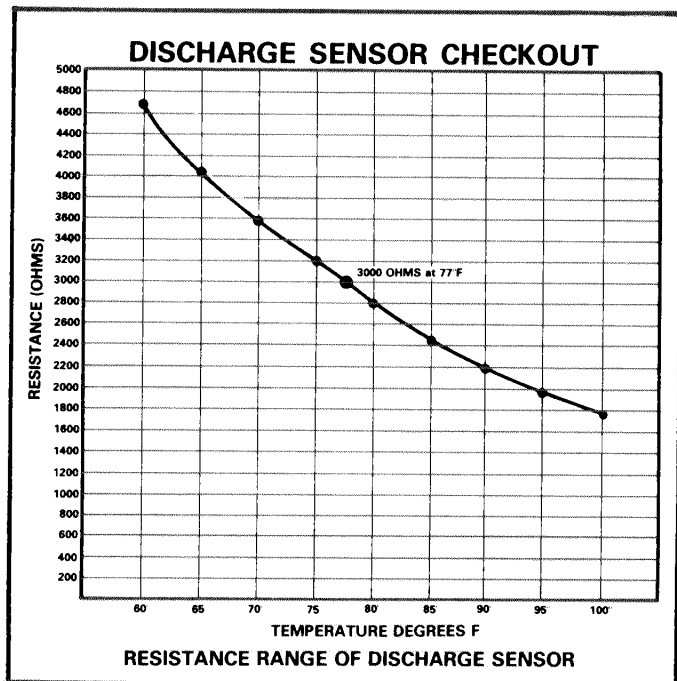

FIGURE 23

D - Logic Panel

- CAUTION - 1. The logic panel must be powered when making these checks.
 2. Line voltage is present on controls near logic panel.
 3. Disconnect power before making any wiring changes. Use care to avoid electrical shock.

Power Supply Check

- 1 - Hook DC voltmeter to terminals 1 and 2 as shown in Figure 24.
- 2 - With 24 VAC to "TR" terminals, voltmeter should read 19 to 20 VDC.

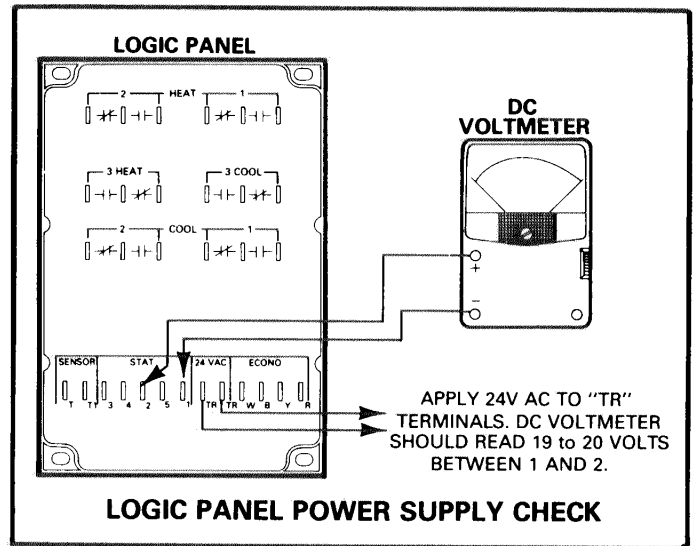

FIGURE 24

Quick Relay Check

- Note - Compressors and electric heat elements will be activated during these checks.
- 1 - Remove the thermostat leads from terminals 1 through 5. Label leads to avoid later miswiring. Apply 24 VAC to "TR" terminals.
 - 2 - Connect jumper from terminals 2 to 5. See Figure 25. All heat stages should activate.
 - 3 - Now connect jumper from terminals 2 to 4. All cool stages should activate.

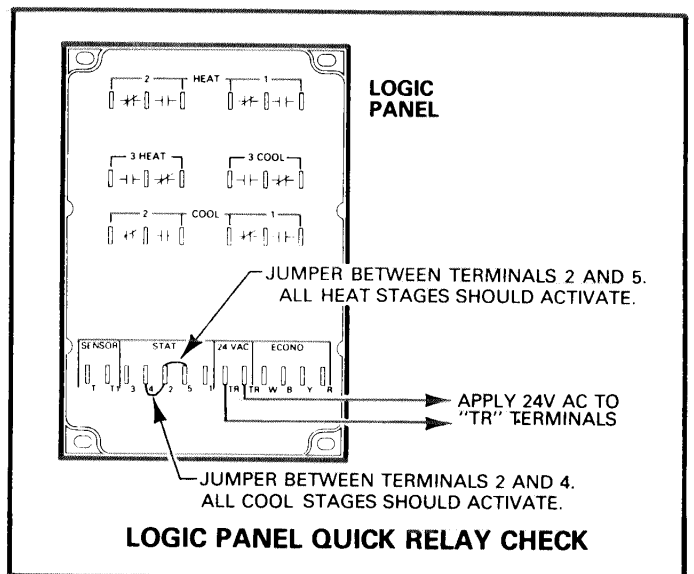

FIGURE 25

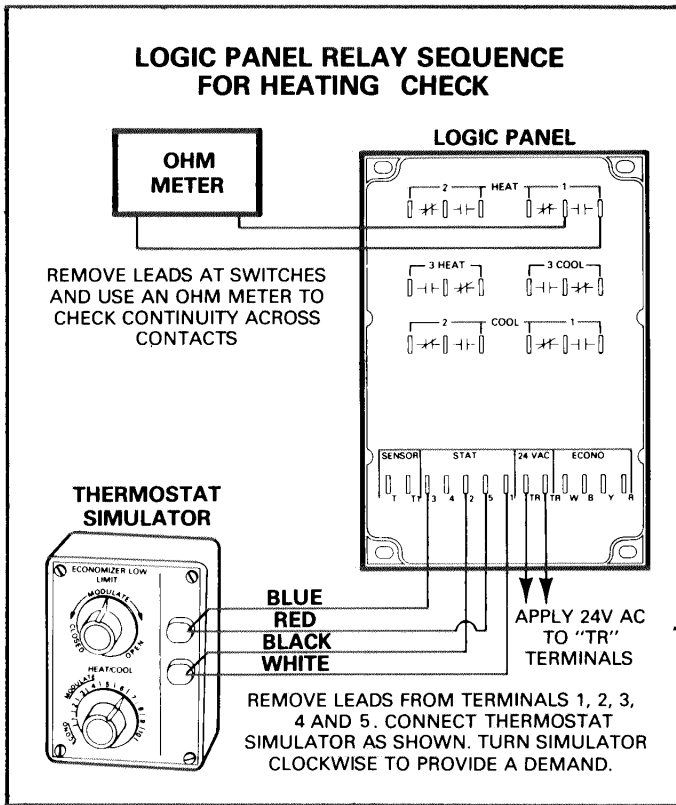

FIGURE 26

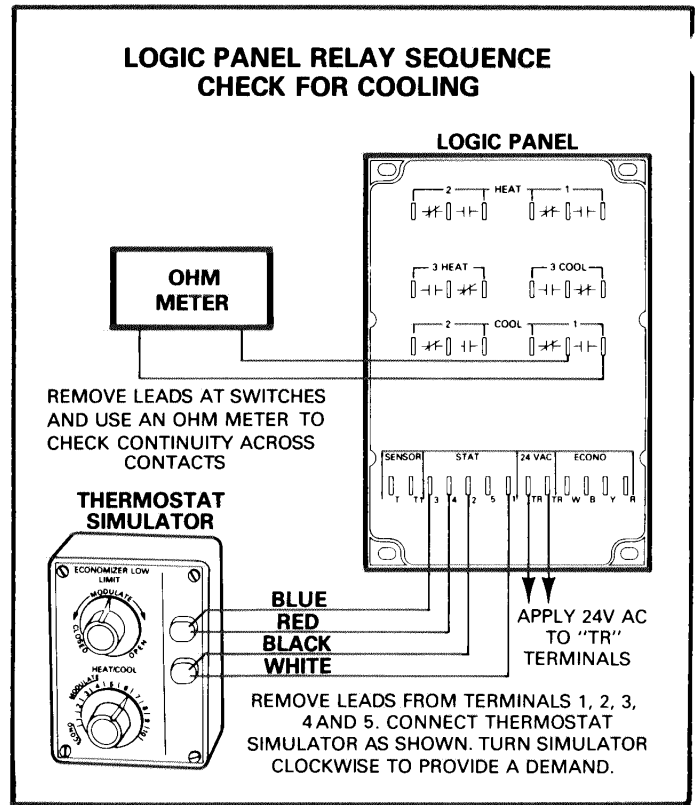

FIGURE 27

Relay Sequence Check

NOTE - The following checkout requires the use of a Thermostat Simulator (58C9501). Remove the thermostat from terminals 1, 2, 3, 4 and 5 on logic panel. Be sure each lead is labeled. Connect simulator as shown in Figures 26 and 27.

- 1 - Slowly turn heat/cool knob on simulator clockwise to provide an increasing demand. The stages should activate in sequence per ramp chart.
- 2 - Slowly turn back the knob counterclockwise to simulate a decreasing demand. The stages should deactivate in reverse sequence per ramp chart.
- 3 - In noisy areas it may be impossible to hear the logic panel relays pull in. Remove the leads at logic panel switches and tape the ends. Use an ohm meter to check continuity across the contacts while simulating a demand. The ohm meter will read zero when the contacts are open and will read infinity when they are closed.

NOTE - Most portable voltmeters are accurate to ± 1 volt. Any variation in starting points should be consistent on voltmeter.

Modulating Heating Output (HoT Water Systems)

The valve motor operates directly off the heating signal from terminals 5 and 1.

- 1 - Connect a DV voltmeter with positive lead to terminal 5 and negative lead to terminal 1. See Figure 28.
- 2 - Slowly turn the heat/cool knob on simulator clockwise to provide a heating demand.
- 3 - The valve motor range is 6 - 9 VDC. At 9 VDC the valve should be completely open.

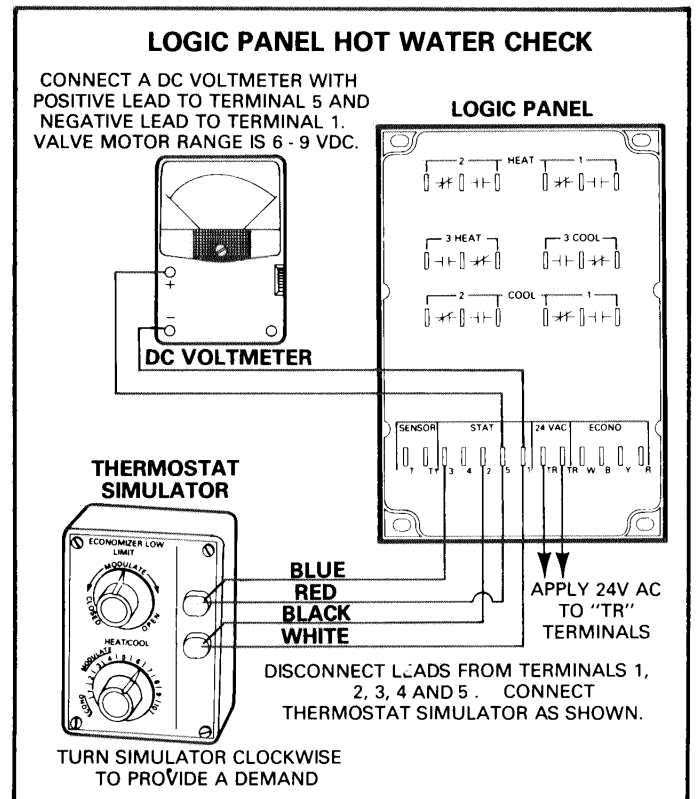

FIGURE 28

- 4 - If the motor does not respond to the heating call, check the system wiring. Make sure all limits and relay contacts are closed in the motor valve circuit. Be sure system selector switch is in the "Heat" or "Auto" position (if used).

- 5 - If wiring is correct and motor does not operate, check the unit service manual for valve motor checkout.
- 6 - Slowly turn heat/cool knob counter-clockwise to simulate a decreasing heating demand. The motor should close.

Power Saver Checkout (Voltmeter)

- 1 - Disconnect the power saver lead to terminal W on the logic panel and connect simulator as shown in Figure 29. Also connect a DC voltmeter (set to 2.5 volt scale) with negative lead to R and positive lead to W.
- 2 - Turn power saver low limit knob fully clockwise to simulate a rise in discharge temperature. Slowly turn the heat/cool knob clockwise to provide a cooling demand.
- 3 - The meter should rise from 0 to approximately 1.5 VDC.
- 4 - Slowly turn the power saver low limit knob counter-clockwise to simulate a decrease in discharge temperature. The voltage should fall from 1.5 VDC to 0.

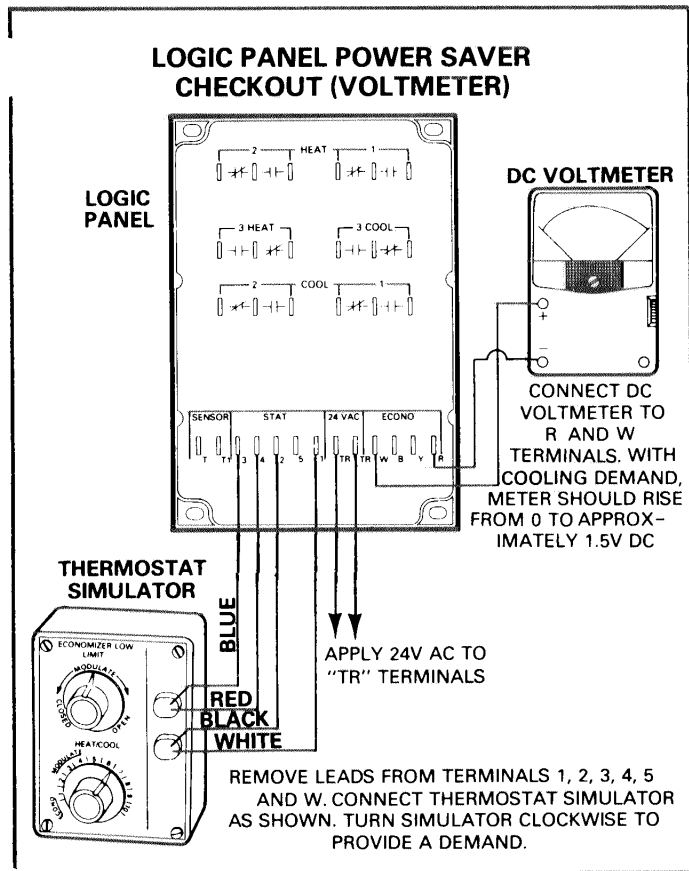

FIGURE 29

- 5 - Turn the power saver low limit knob fully clockwise to simulate a rise in discharge temperature. The voltage should rise to approximately 1.5 VDC.
- 6 - Slowly turn the heat/cool knob counter-clockwise to simulate a decreased cooling demand. The power saver motor should close.
- 7 - Connect the motor lead back to "W". Again turn the knob clockwise to simulate a cooling demand.
- 8 - If the motor does not respond to the signal, check the system wiring. Make sure that the Night Relay and Blower Relay contacts are open and that the enthalpy control is below its setting. If motor still does not operate, proceed to power saver motor checkout.
- 9 - Slowly turn heat/cool knob counter-clockwise to simulate a decreasing cooling demand. The voltage should return to 0.

Power Saver Checkout (Ohm Meter)

- 1 - Disconnect 24 VAC connections at "TR" terminals. Also disconnect power saver motor connections from terminals W, B, Y and R.
- 2 - Using an ohm meter make the resistance measurements called out in Figure 30.

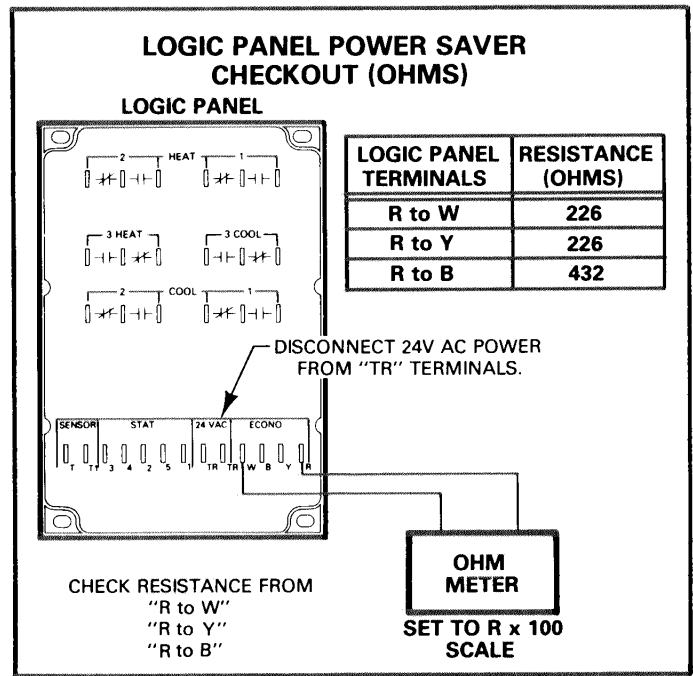

FIGURE 30

E - Power Saver Motor

- 1 - Remove wires from terminals R, W and B on motor.
- 2 - Apply 24 VAC to "TR" terminals at motor.
- 3 - Connect jumper wire to terminals R and W as shown in Figure 31. Outside dampers should drive closed.
- 4 - Now connect jumper wire to terminals R and B. Outside dampers should open.

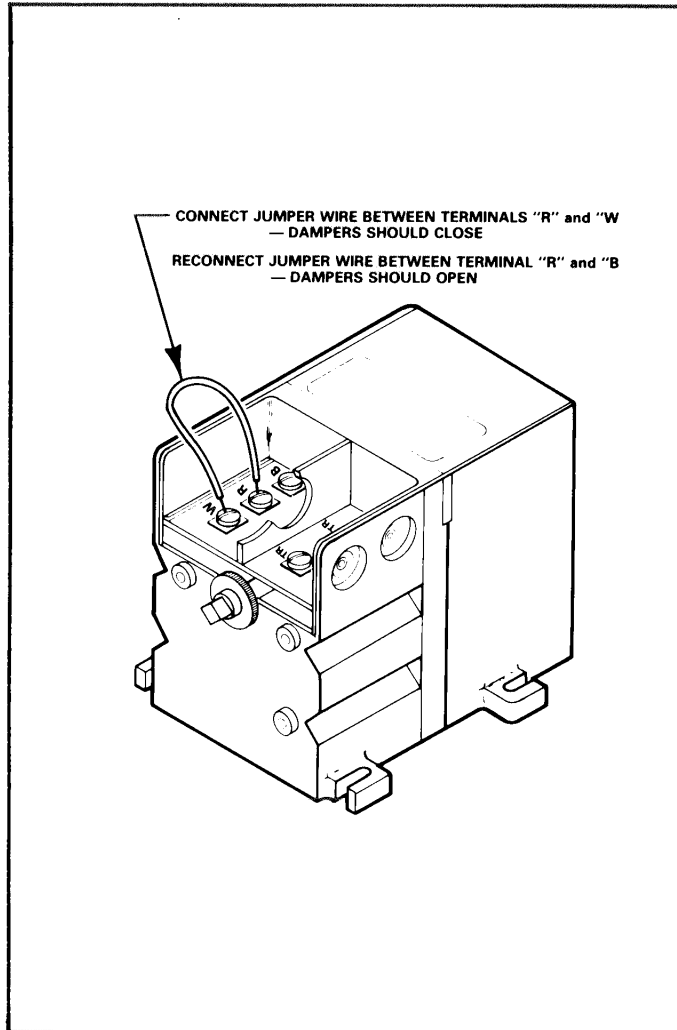

FIGURE 31

F - K23 Voltage Control Relay (Used With Switching Subbase or Switching Status Panel or CHA11 or GCS11 Units)

This relay is not needed on heat pumps.

- 1 - Connect the simulator as shown in Figure 32. Also connect a DC voltmeter with the positive lead to terminal 4 and negative lead to terminal 1 on logic panel.
- 2 - Set fan switch to "Auto". The blower motor will be de-energized with the heat/cool knob turned counter-clockwise.
- 3 - Slowly turn knob clockwise to simulate a cooling demand. At approximately 4VDC the relay should make to energize the blower relay and consequently the blower motor.
- 4 - Slowly turn the knob counter-clockwise to decrease the demand. The blower motor should de-energize at 2.5 - 3 VDC.

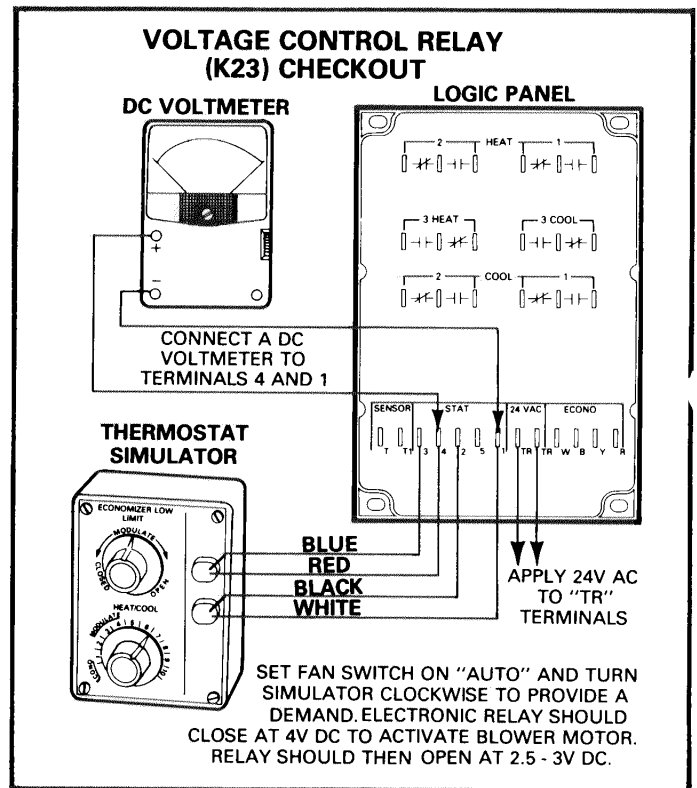

FIGURE 32

G - Upon Completion of Checkouts

Turn off power and remove thermostat simulator. Replace thermostat and discharge sensor leads and restore power.