

- BM 50

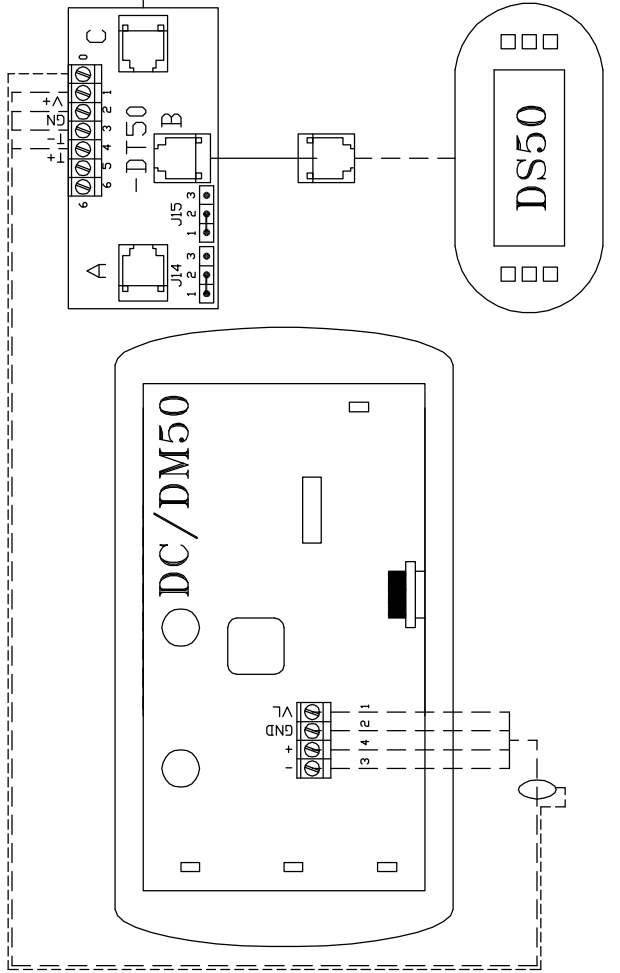
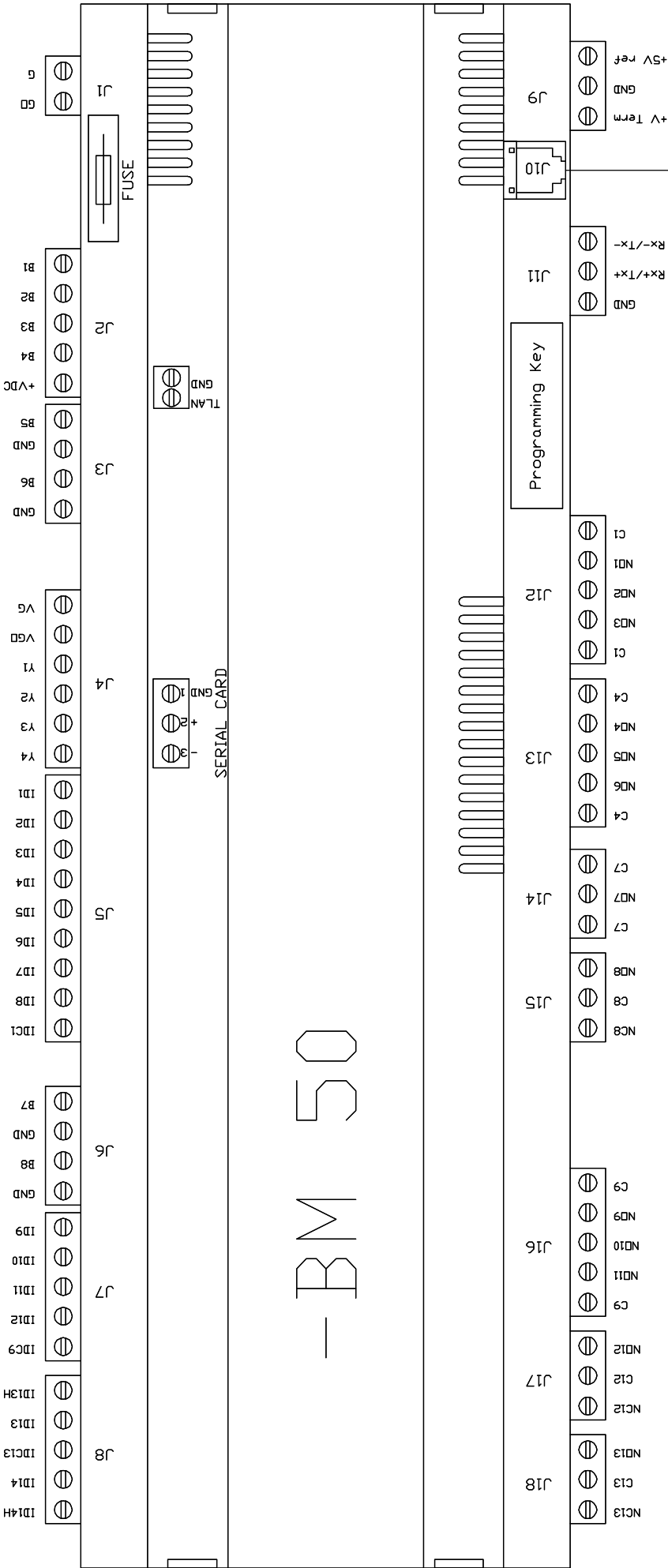

Input B1-B2-B3-B4

	1	Input
OFF	OFF	0/1V
DN	DN	NTC
		0/20mA
		0/5V

Input B5-B6

Input	digital input	NTC
DN	DN	OFF
OFF	OFF	NTC

Input B1-B2-B3-B4

	1	Input
OFF	OFF	0/1V
DN	DN	NTC
		0/20mA
		0/5V

Input B5-B6

Input	digital input	NTC
DN	DN	OFF
OFF	OFF	NTC

AVEC TCB SANS CARTE EXTENSION
WITHOUT EXTENSIONBOARD BE50

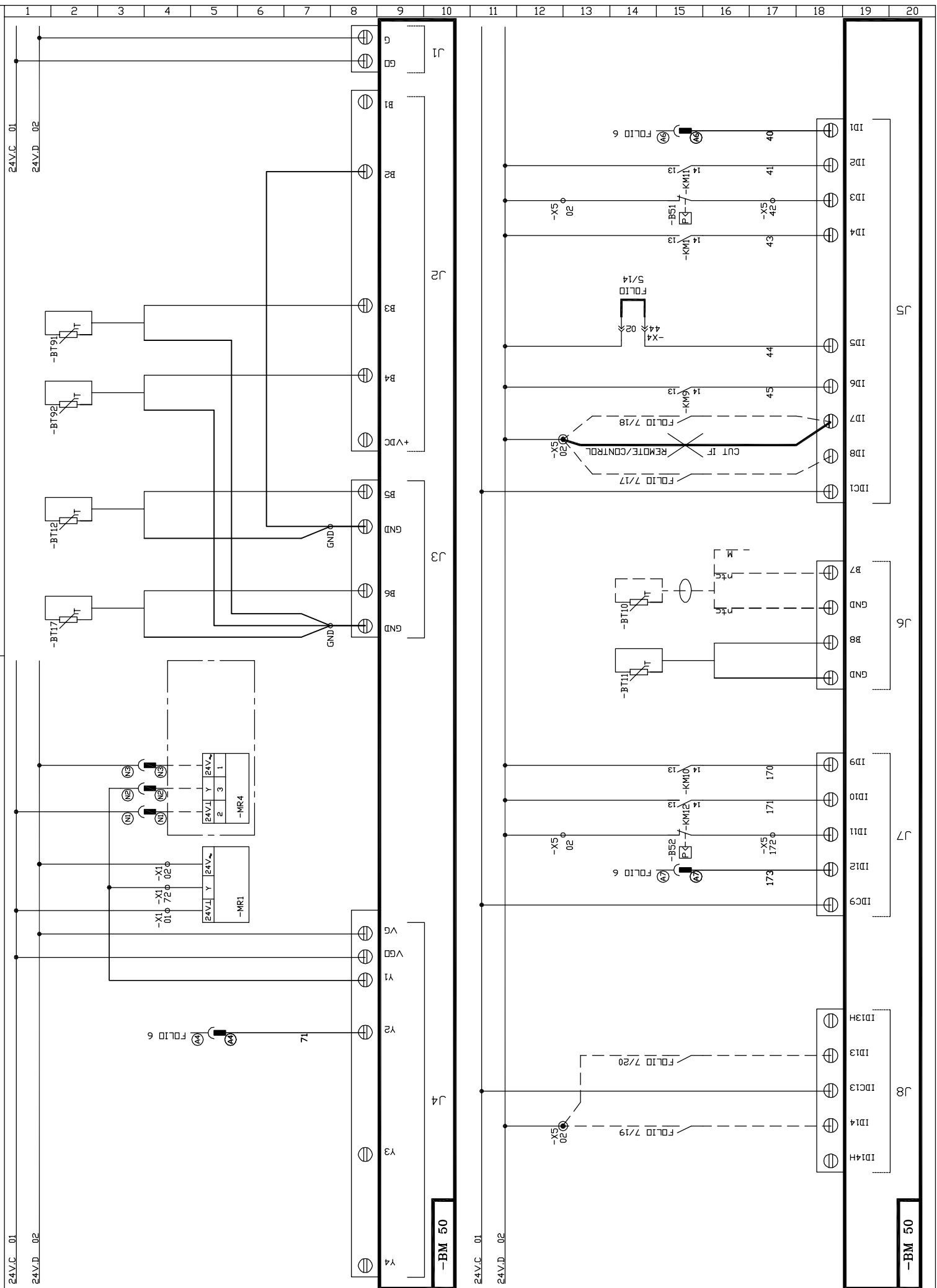

Indice	DATE	NOM	MODIFICATIONS

(1) BHK 040 ND
Entrées Automate CLIMATIC 50
Climatic 50 Controller Input

Dessine: CTO
Date: 31.01.07



253180 3/11

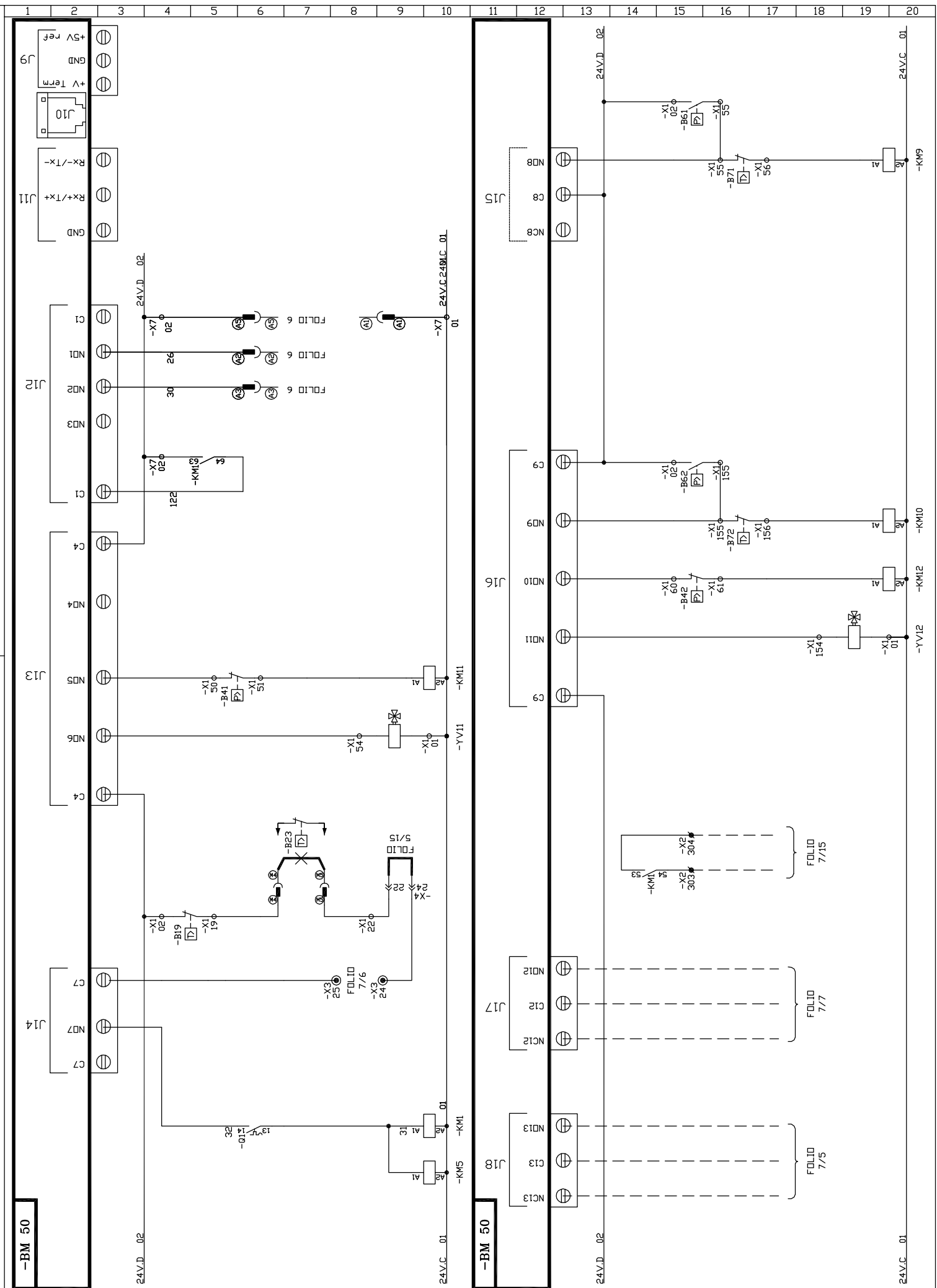

Indice	DATE	NOM	MODIFICATIONS

(1) BHK 040 ND
Sorties Automate CLIMATIC 50
Climatic 50 Controller Outputs

Dessine: CTO
Date: 31.01.07



253180 4/11

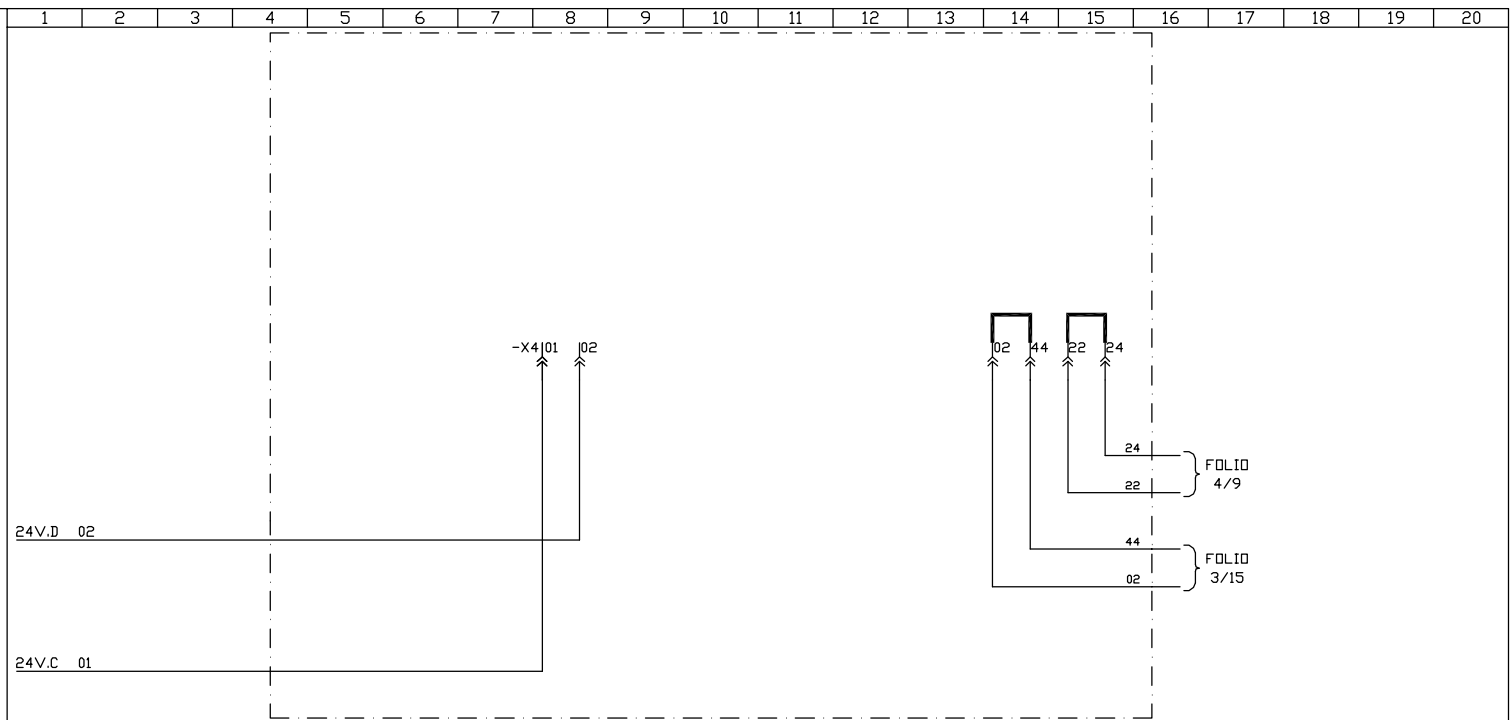

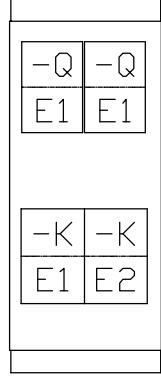
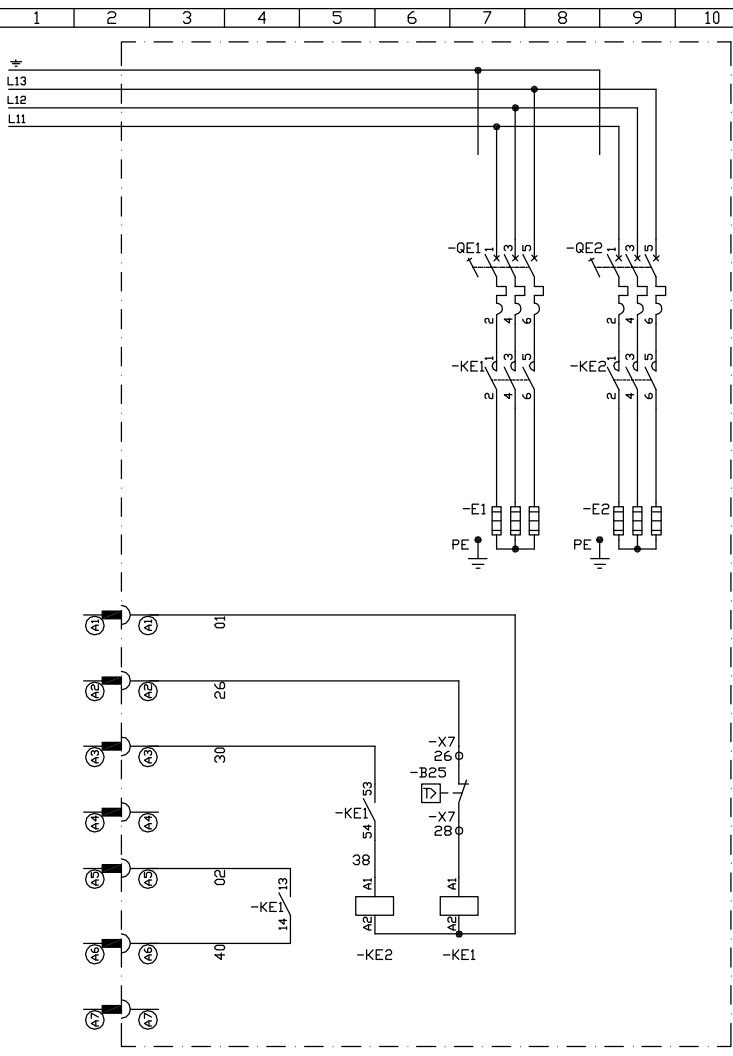

REPERE	REFERENCE	CODE	Nb
-QE1	C60N 20A TRIPOL COURBE C	4480513R	1
-QE2	C60N 32A TRIPOL COURBE C	4480515V	1
-KE1	LC1 D0910 B7	4410650A	1
-KE1	LA1 DN11	5410082F	1
-KE2	LC1 D1810 B7	4410652F	1

Indice	DATE	NOM	MODIFICATIONS

(1) BHK 040 ND
Kit chauffage
GAS

Dessine: CTO
Date: 31.01.07



253180 6/11

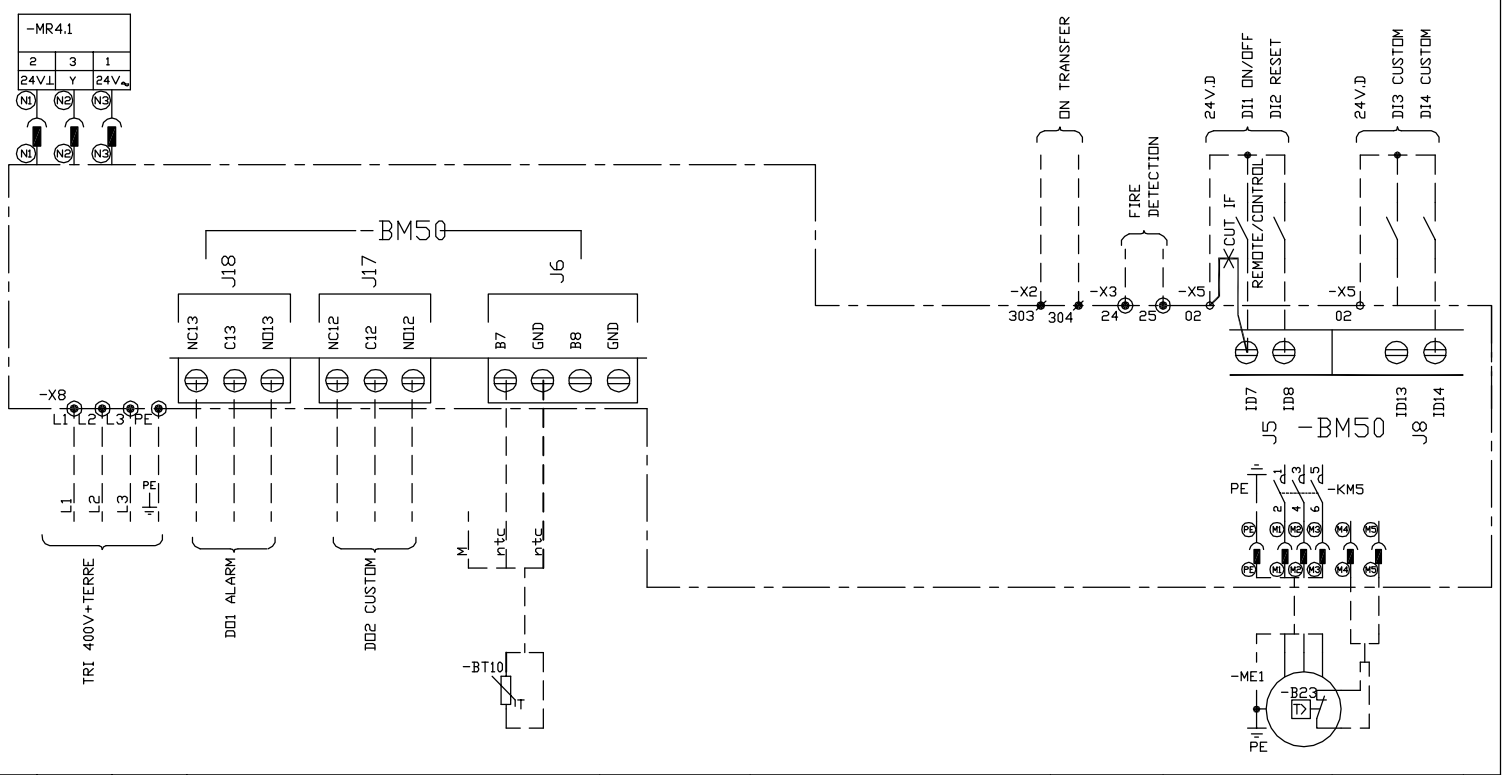
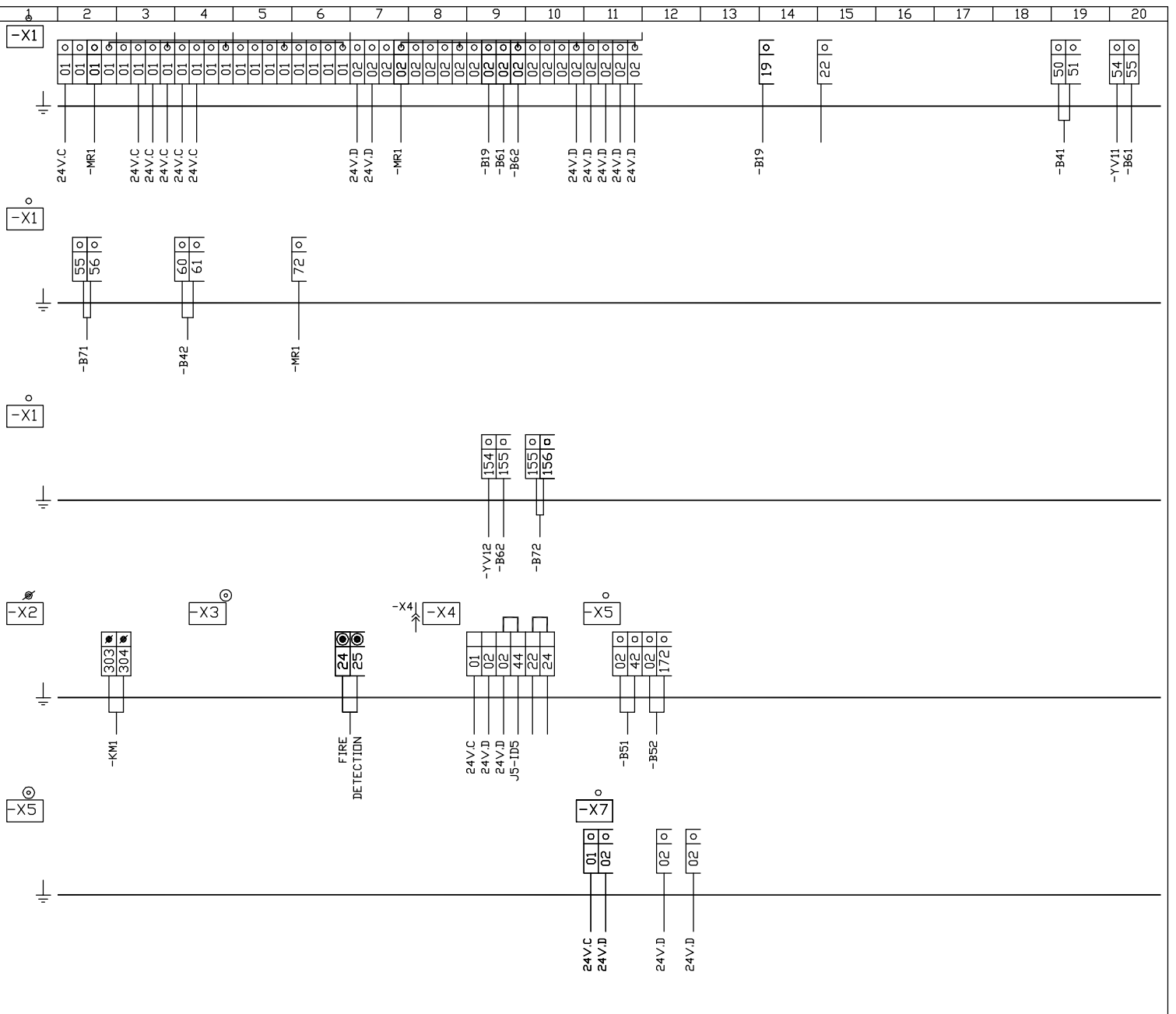

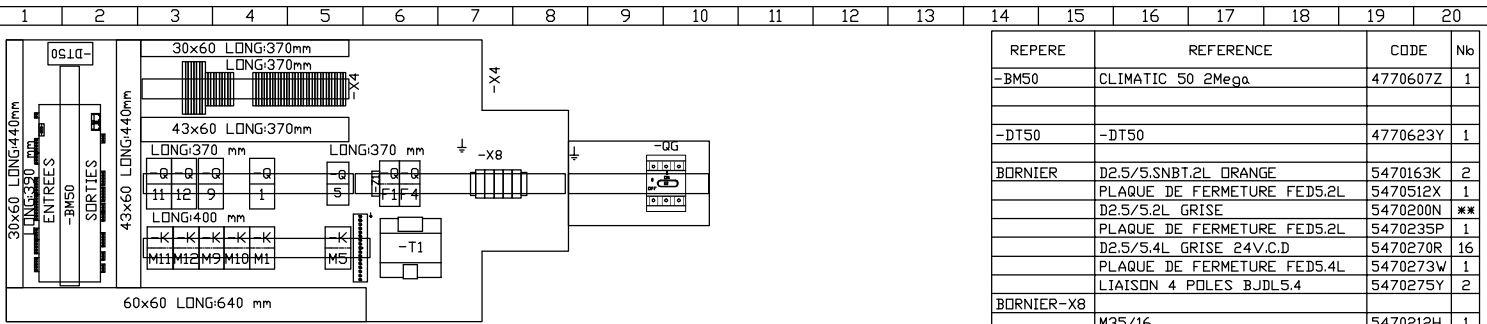

REPERE	REFERENCE	CODE	Nb
-QG	INTER DT 100 E3	448068P	1
-QG	POIGNEE DE MANOEUVRE DHY2AJ	448066L	1
-QG	ARBRE DE MANOEUVRE DX330	4480660J	1
PRDFIL	OMEGA 35x7.5x1.5 LONG:160mm	5740142E	1
BARRETTE	TYPE MG 14979	5470186T	1
-QF1	C60N 24583 4A BIPOL COURBE D	4480591H	1
-QF4	C60N 24584 6A BIPOL COURBE D	4480592J	1
-T1	160VA PRIMAIRE 400V /24V	4430121L	1
-Z1	LRC V2-0.22-220/400V	4770010X	1
-Q5	GV2 M08 2.5/4 A	4410846P	1
-KM5	LC1 D09 B7	4410650A	1

REPERE	REFERENCE	CODE	Nb
-Q1	GV2 M20 13/18 A	4410850W	1
-Q1	GV2 AE 113	4410891J	1
-KM1	LC1 D12 B7	4410651E	1
-KM1	LA DN403	5410092V	1
-Q11-Q12	GV2 M203 13/18 A	4410883W	2
-KM11-KM12	LC1 D123 B7	4410651E	2
-Q9	GV2 M14 6/10A	4410848T	1
-KM9	LC1 D09 B7	4410650A	1
-KM10	LC1 D09 B7	4410650A	1

REPERE	REFERENCE	CODE	Nb
-BM50	CLIMATIC 50 2Mega	4770607Z	1
-DT50	-DT50	4770623Y	1
BORNIER	D2.5/5.SNBT.2L DRANGE	5470163K	2
	PLAQUE DE FERMETURE FED5.2L	5470512X	1
	D2.5/5.2L GRISE	5470200N	**
	PLAQUE DE FERMETURE FED5.2L	5470235P	1
	D2.5/5.4L GRISE 24V.C.D	5470270R	16
	PLAQUE DE FERMETURE FED5.4L	5470273W	1
	LIAISON 4 POLES BJDLS.4	5470275Y	2
BORNIER-X8			
	M35/16	5470212H	1
	M35/16	5470204V	3
	PLAQUE DE FERMETURE	5470237T	1
BUTEE	103 002 26	5470240X	2
-Q11-Q12	GV2 M203 13/18 A	4410883W	2
-KM11-KM12	LC1 D123 B7	4410651E	2
-Q9	GV2 M14 6/10A	4410848T	1
-KM9	LC1 D09 B7	4410650A	1
-KM10	LC1 D09 B7	4410650A	1

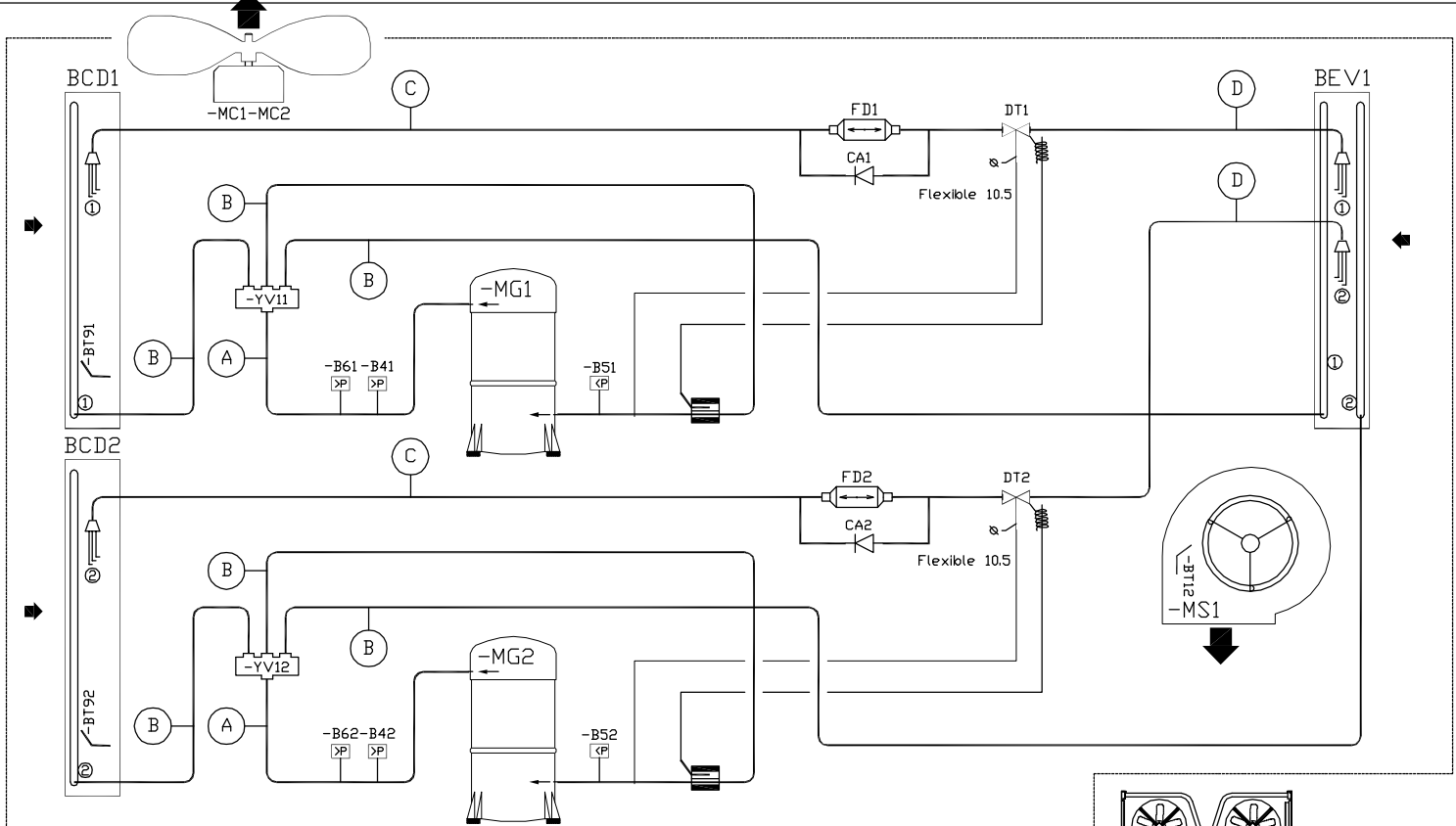

BDX	30/35	40	-MG1	45	-MG2	50	60	70
D	5/8"	5/8"	5/8"	7/8"	7/8"	7/8"	7/8"	7/8"
C	1/2"	1/2"	1/2"	5/8"	5/8"	5/8"	5/8"	5/8"
B	7/8"	1 1/8"	1 1/8"	1 1/8"	1 1/8"	1 1/8"	1 1/8"	1 3/8"
A	5/8"	7/8"	7/8"	7/8"	7/8"	7/8"	7/8"	7/8"

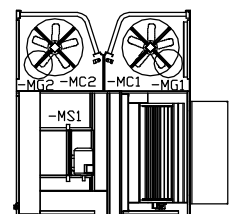

Indice	DATE	NOM	MODIFICATIONS

(1) BHK 040 ND
 Schéma Frigorifique \ Hydraulique
 Cooling \ Hydraulic Diagram

Dessine: CTO
 Date: 31.01.07



253180 9/11
 USINE DE LONGVIC

