

- BM 50

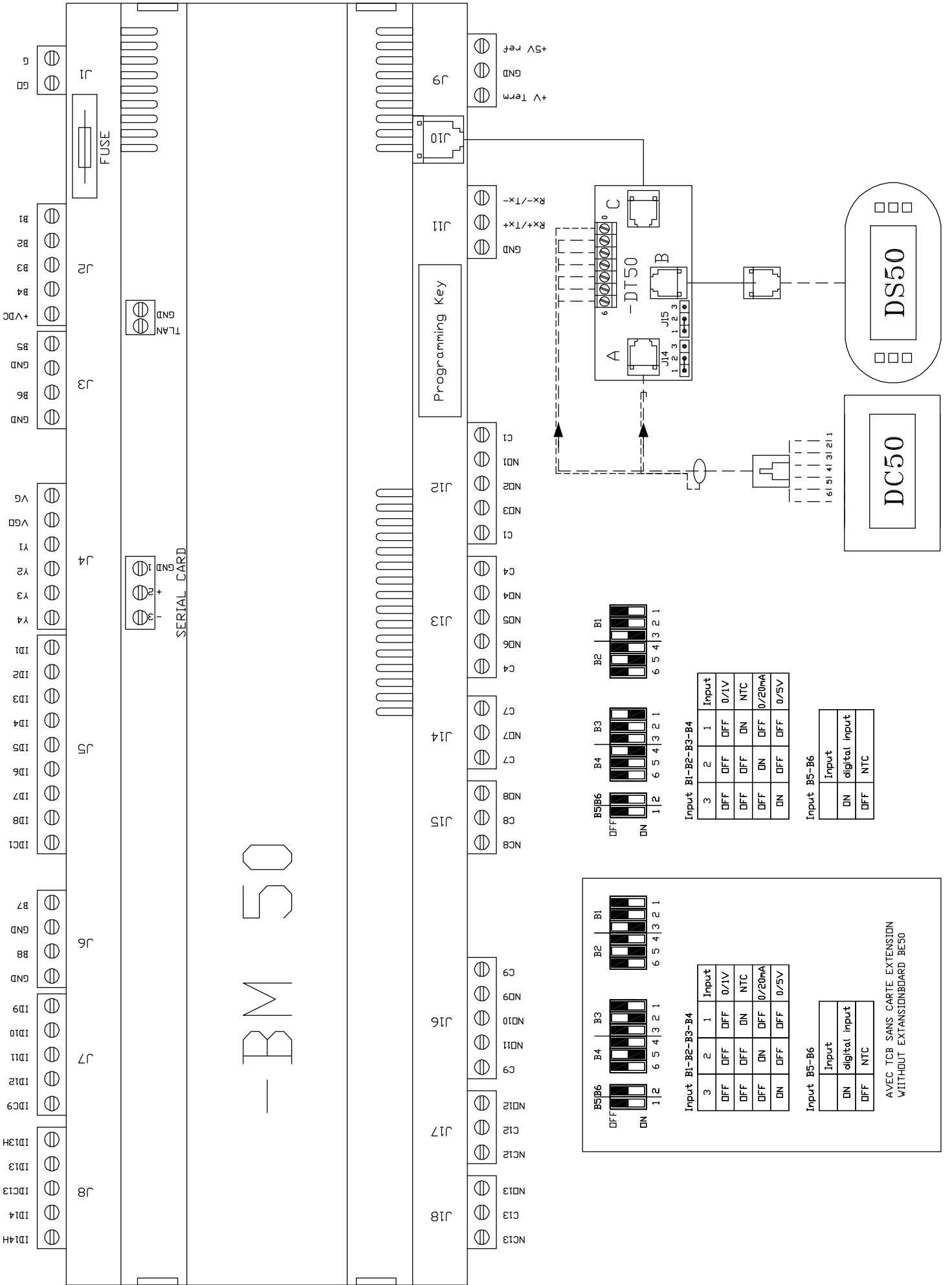

Input B1-B2-B3-B4

| Input | 1 | 2 | 3 |
|--------|-----|-----|-----|
| 0/1V | OFF | OFF | OFF |
| NTC | DN | OFF | OFF |
| 0/20mA | OFF | DN | OFF |
| 0/5V | OFF | OFF | DN |

Input B5-B6

| Input | digital input | NTC |
|-------|---------------|-----|
| DN | OFF | OFF |

Input B1-B2-B3-B4

| Input | 1 | 2 | 3 |
|--------|-----|-----|-----|
| 0/1V | OFF | OFF | OFF |
| NTC | DN | OFF | OFF |
| 0/20mA | OFF | DN | OFF |
| 0/5V | OFF | OFF | DN |

Input B5-B6

| Input | digital input | NTC |
|-------|---------------|-----|
| DN | OFF | OFF |

AVEC TCB SANS CARTE EXTENSION
WITHOUT EXTENSIONBOARD BE50

(1) BHK 030 ND
Automate CLIMATIC 50
Climatic 50 Controller

Dessine: T/Y
Date: 09.02.06



246798 2/11

| Indice | DATE | NOM | MODIFICATIONS |
|--------|------|-----|---------------|
| | | | |

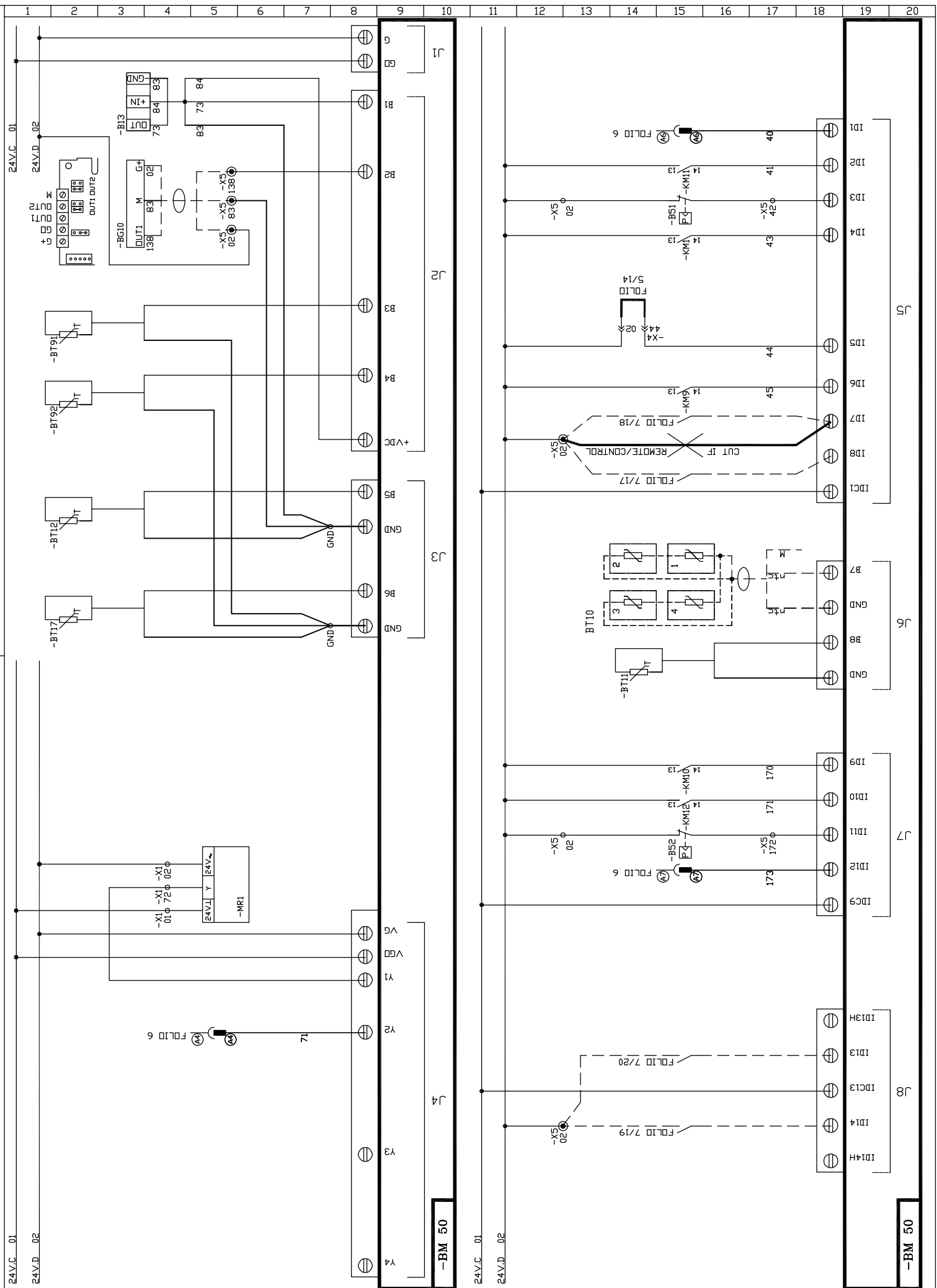

| Indice | DATE | NOM | MODIFICATIONS |
|--------|------|-----|---------------|
| | | | |

(1) BHK 030 ND
Entrées Automate CLIMATIC 50
Climatic 50 Controller Input

Dessine: T/Y
Date: 09.02.06



246798 3/11

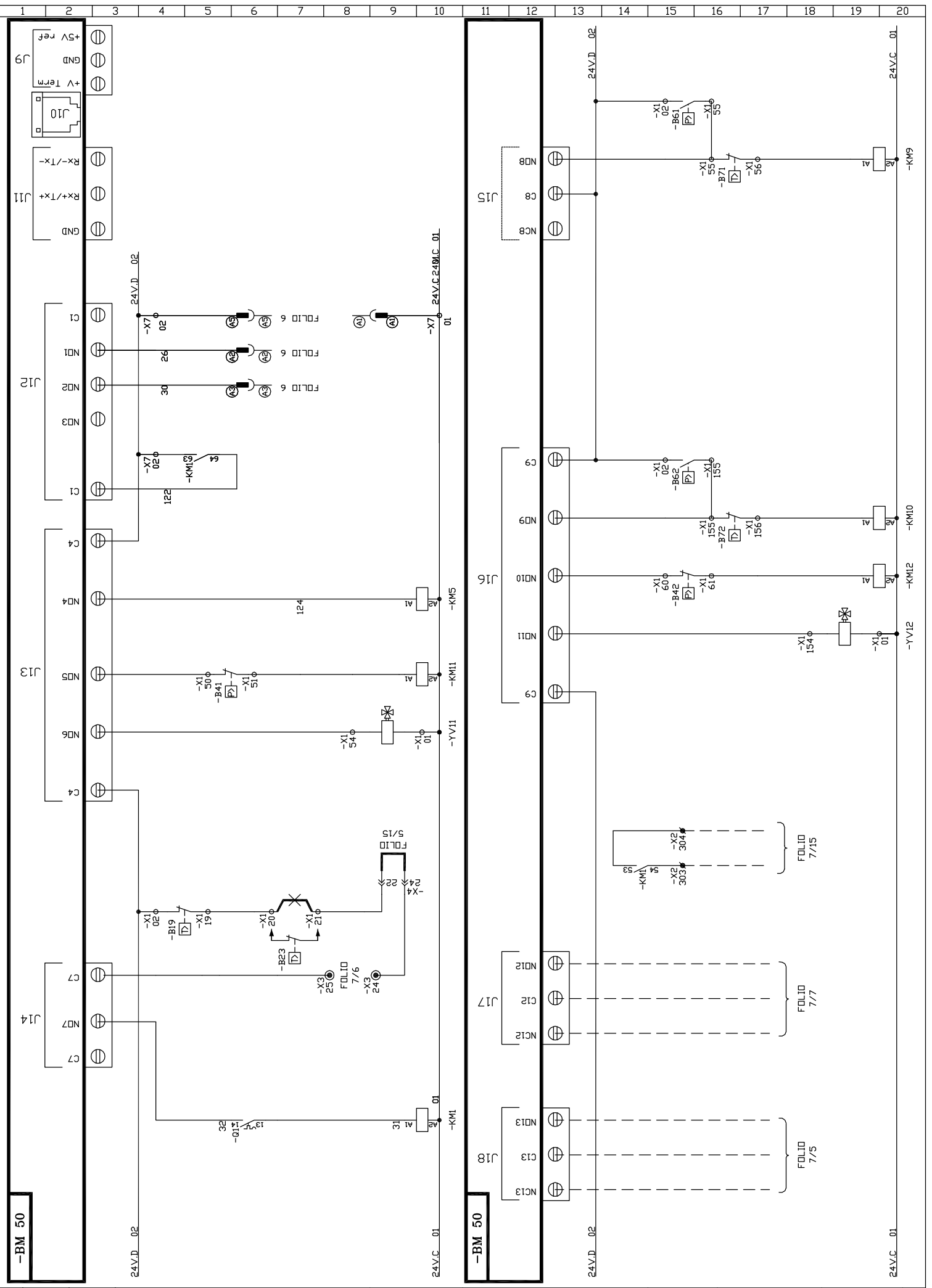

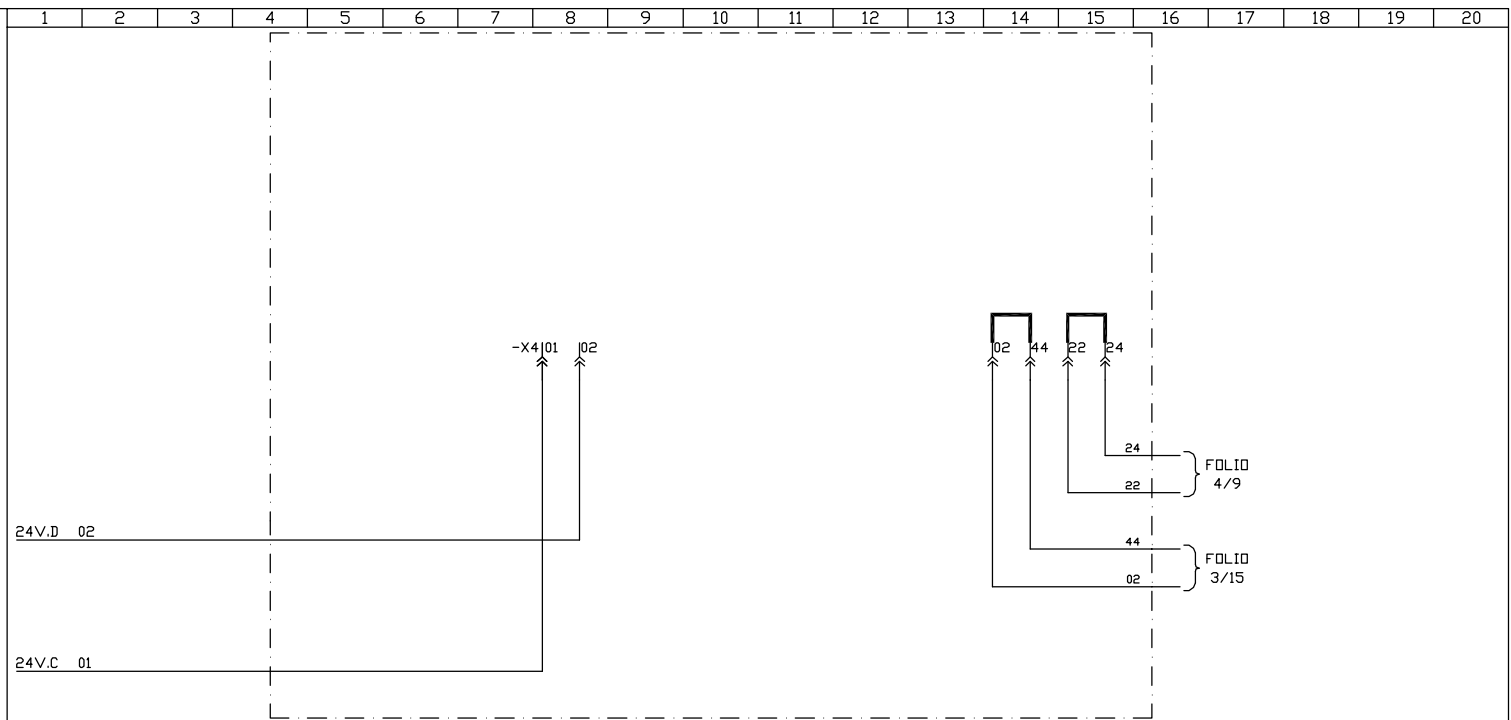

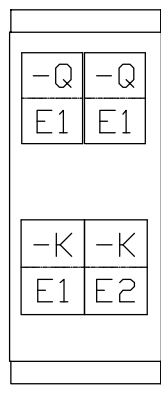
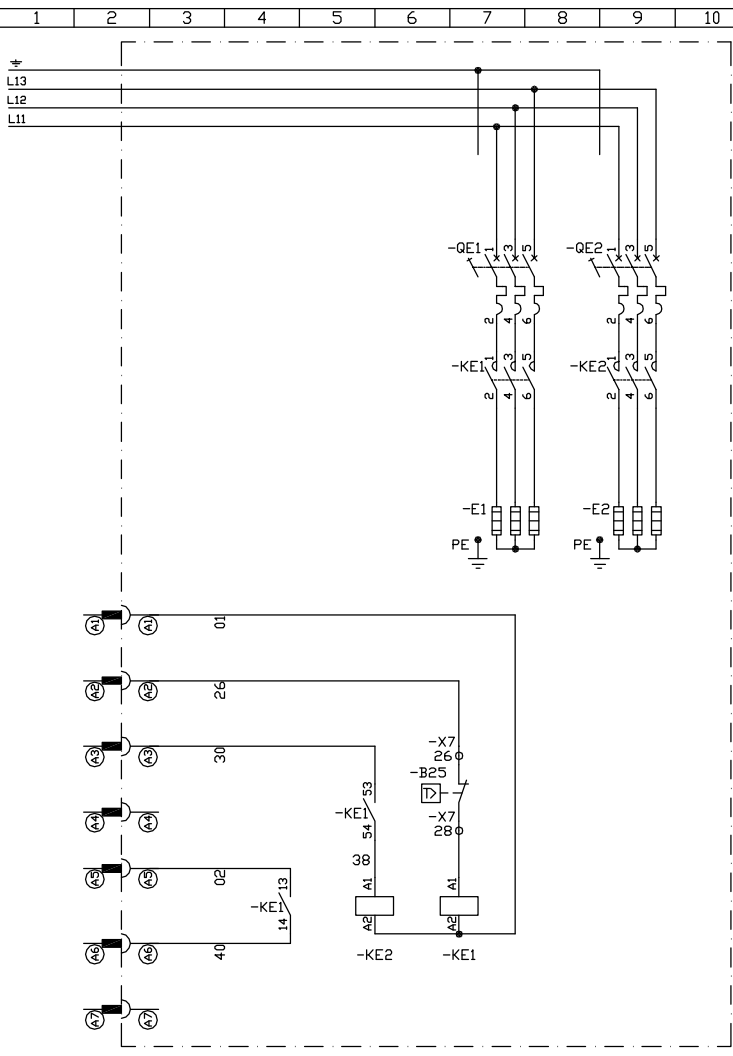

| REPERE | REFERENCE | CODE | Nb |
|--------|--------------------------|----------|----|
| -QE1 | C60N 20A TRIPOL COURBE C | 4480513R | 1 |
| -QE2 | C60N 20A TRIPOL COURBE C | 4480513R | 1 |
| -KE1 | LC1 D0910 B7 | 4410650A | 1 |
| -KE1 | LA1 DN11 | 5410082F | 1 |
| -KE2 | LC1 D0910 B7 | 4410650A | 1 |

| Indice | DATE | NOM | MODIFICATIONS |
|--------|------|-----|---------------|
| | | | |

(1) BHK 030 ND
Kit chauffage
GAS

Dessine: T/Y
Date: 09.02.06



246798 6/11

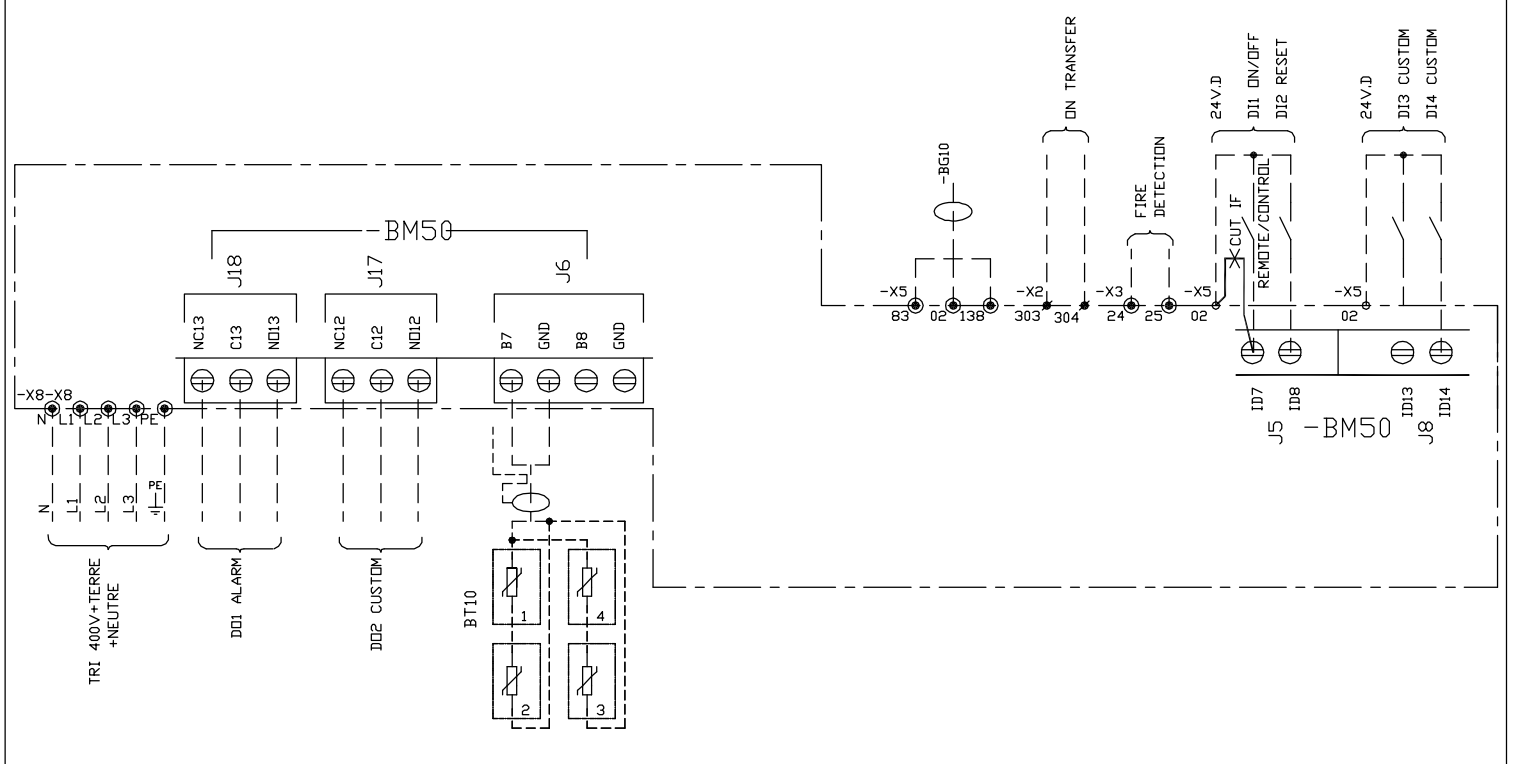
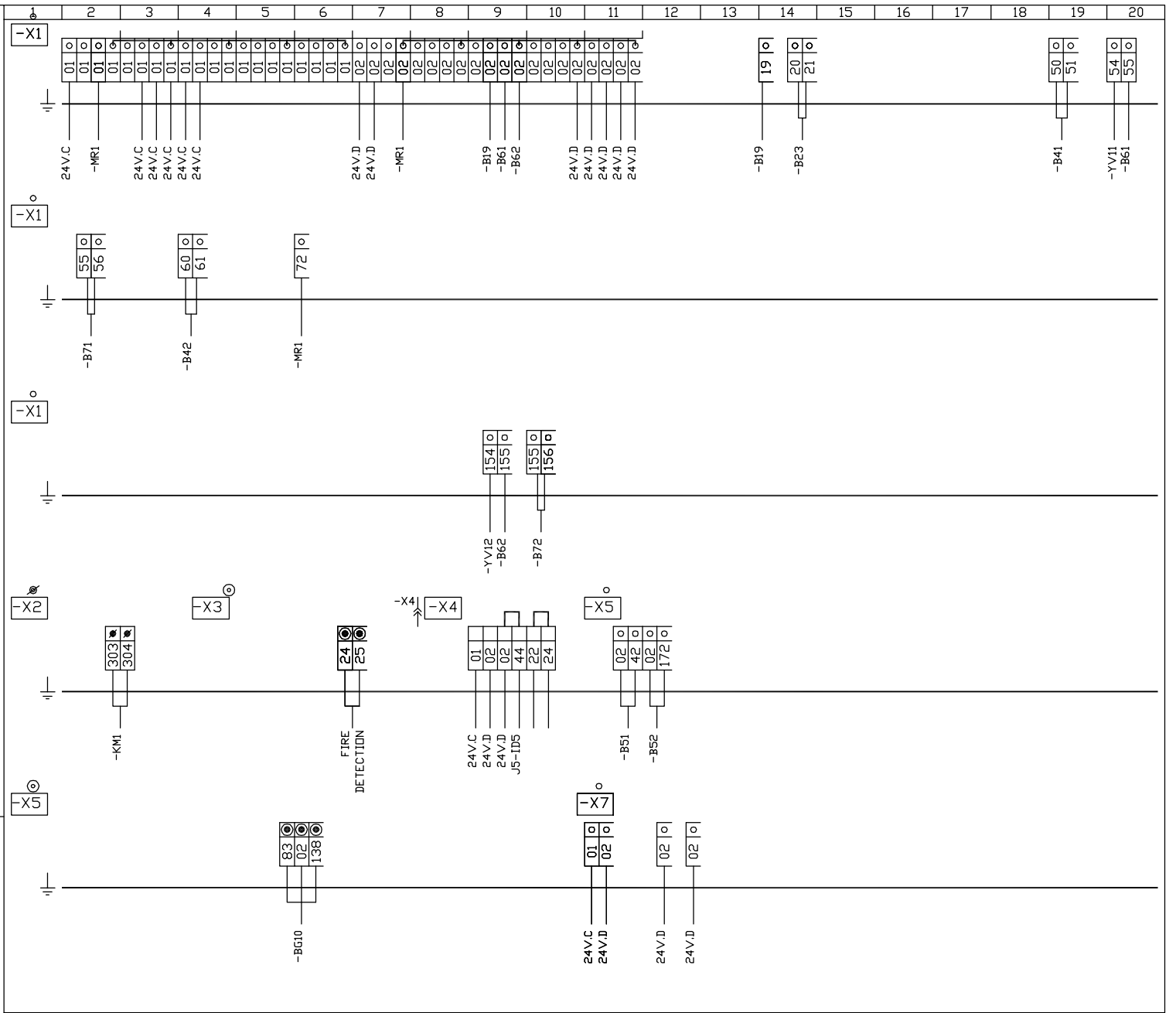

| Indice | DATE | NOM | MODIFICATIONS |
|--------|------|-----|---------------|
| | | | |

(1) BHK 030 ND
 Borniers \ Raccordement Client
 Terminal Strip \ Customer

Dessine: T/Y
 Date: 09.02.06



246798 7/11

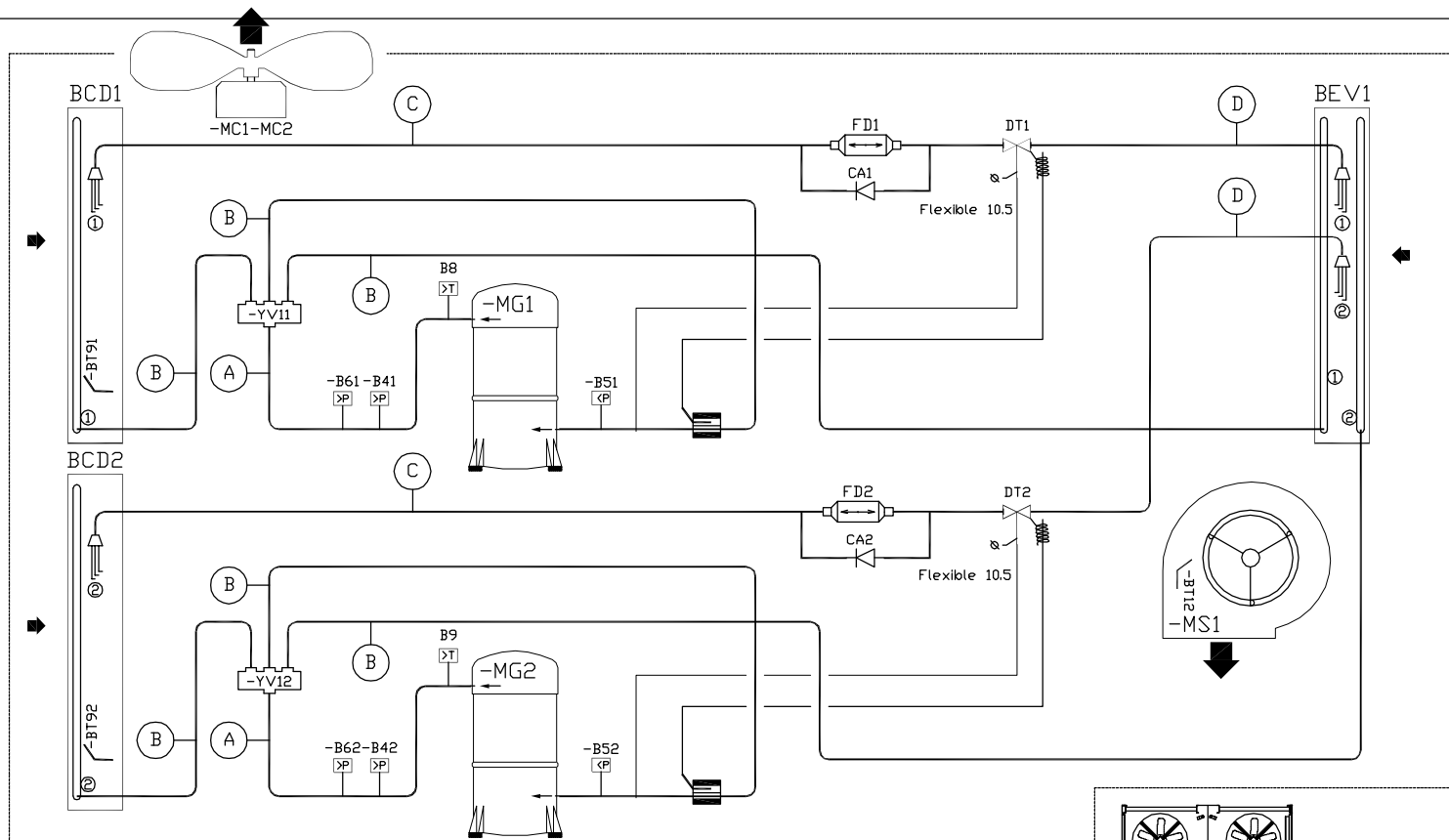

| BDX | 30/35 | 40 | -MG1 | 45 | -MG2 | 50 | 60 | 70 |
|-----|-------|--------|--------|--------|--------|--------|--------|--------|
| D | 5/8" | 5/8" | 5/8" | 7/8" | 7/8" | 7/8" | 7/8" | 7/8" |
| C | 1/2" | 1/2" | 1/2" | 5/8" | 5/8" | 5/8" | 5/8" | 5/8" |
| B | 7/8" | 1 1/8" | 1 1/8" | 1 1/8" | 1 1/8" | 1 1/8" | 1 1/8" | 1 3/8" |
| A | 5/8" | 7/8" | 7/8" | 7/8" | 7/8" | 7/8" | 7/8" | 7/8" |

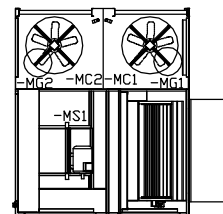

| Indice | DATE | NOM | MODIFICATIONS |
|--------|------|-----|---------------|
| | | | |

(1) BHK 030 ND
 Schéma Frigorifique \ Hydraulique
 Cooling \ Hydraulic Diagram

Dessine: T/Y
 Date: 09.02.06



246798

9/11

