

Indice	DATE	NOM	MODIFICATIONS
			
<i>Waltham Abbey</i>			
(1) BHK 020 NS LENNOX UK		Dessine: T/Y Date: 16.10.06	PAGE DE GARDE <div style="border: 1px solid black; padding: 2px;">251030</div> <div style="border: 1px solid black; padding: 2px;">0 / 11</div>

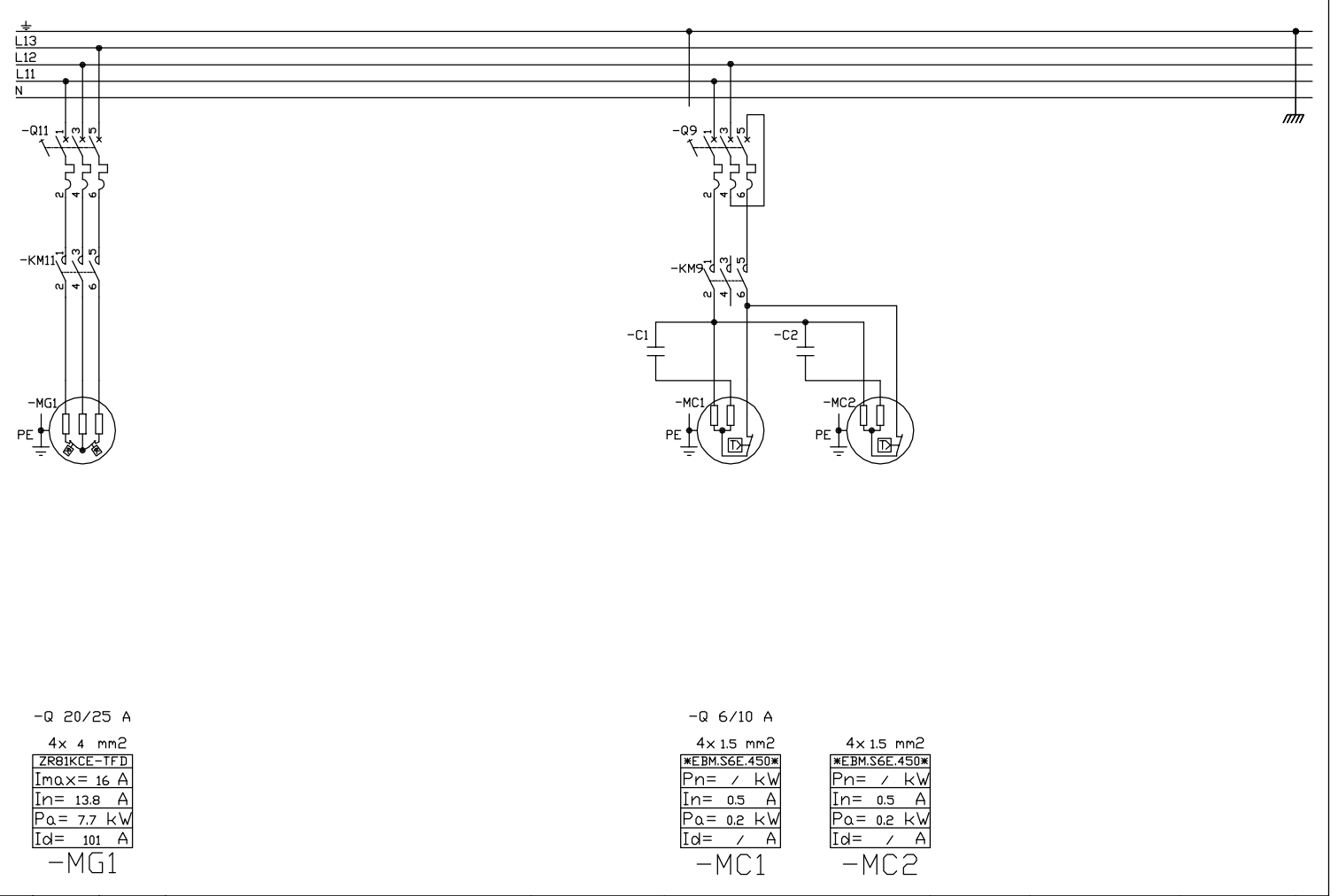

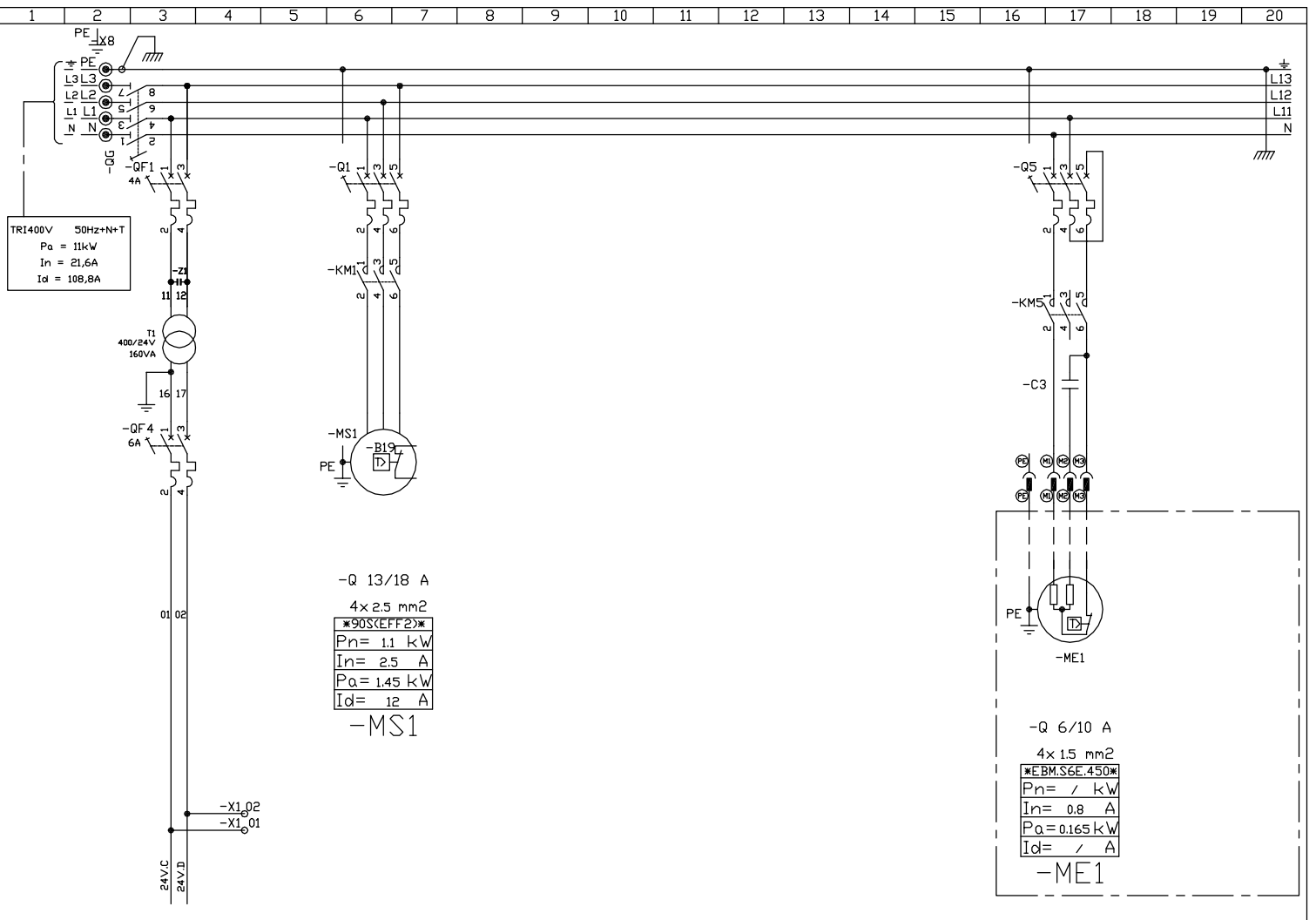

- BM 50

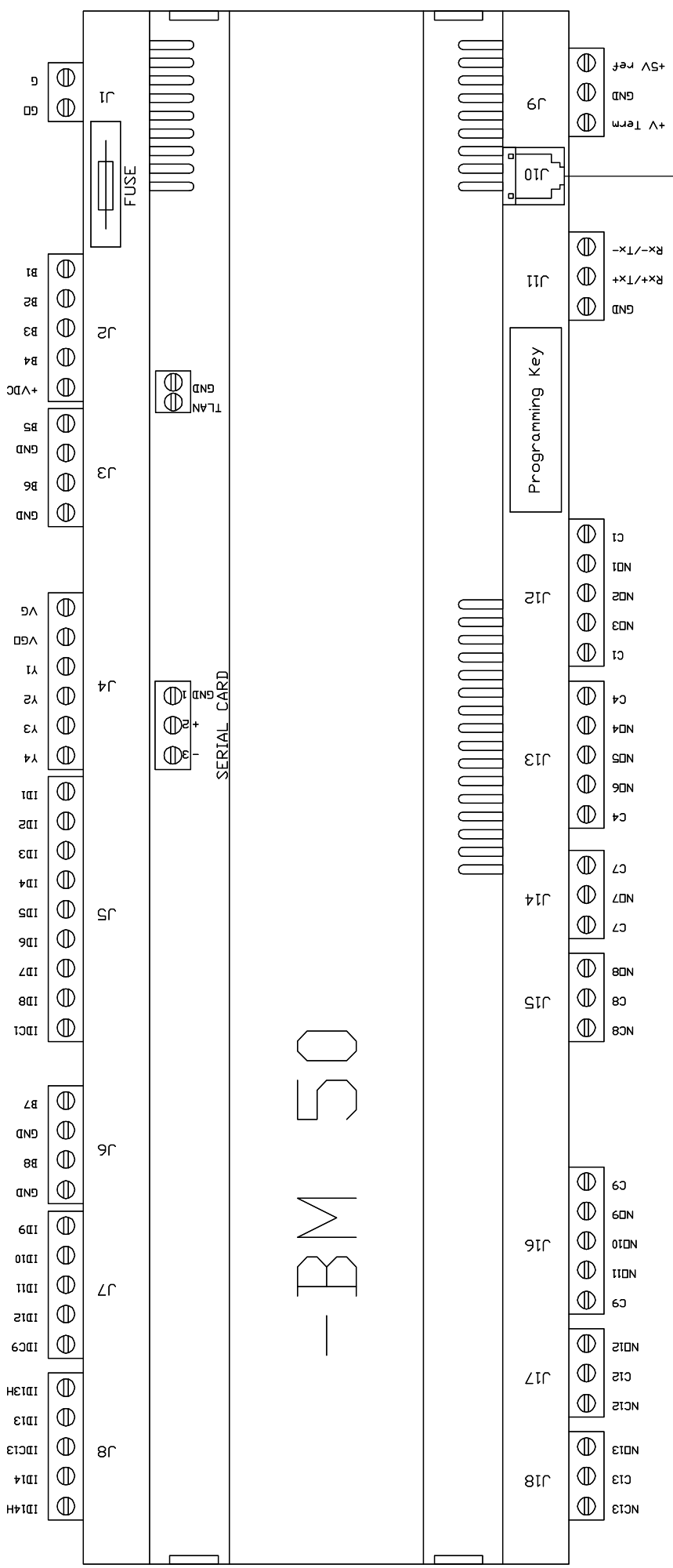
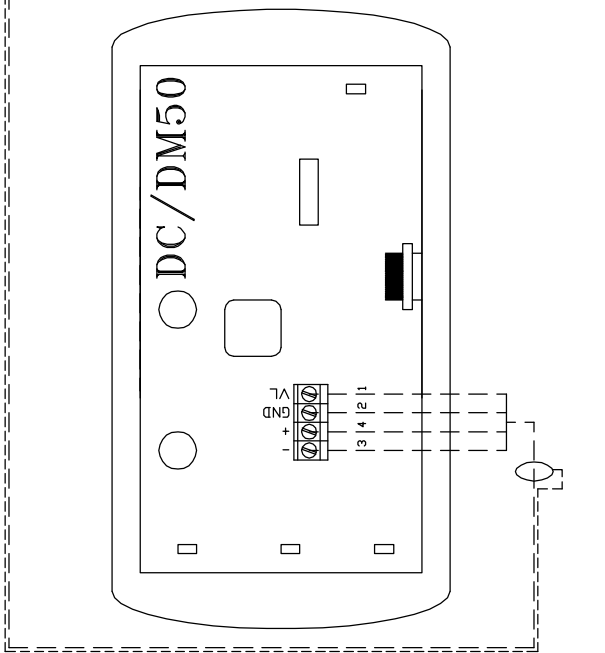
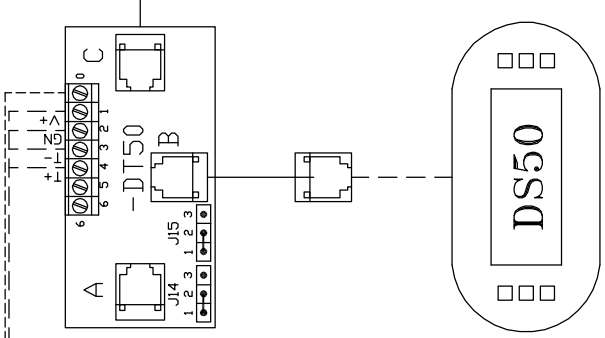

Input B1-B2-B3-B4

	1	Input
OFF	OFF	0/1V
DN	DN	NTC
DN	DN	0/20mA
DN	DN	0/5V

Input B5-B6

Input	digital input	NTC
DN	DN	OFF

Input B1-B2-B3-B4

	1	Input
OFF	OFF	0/1V
DN	DN	NTC
DN	DN	0/20mA
DN	DN	0/5V

Input B5-B6

Input	digital input	NTC
DN	DN	OFF

AVEC TCB SANS CARTE EXTENSION
WITHOUT EXTENSIONBOARD BE50

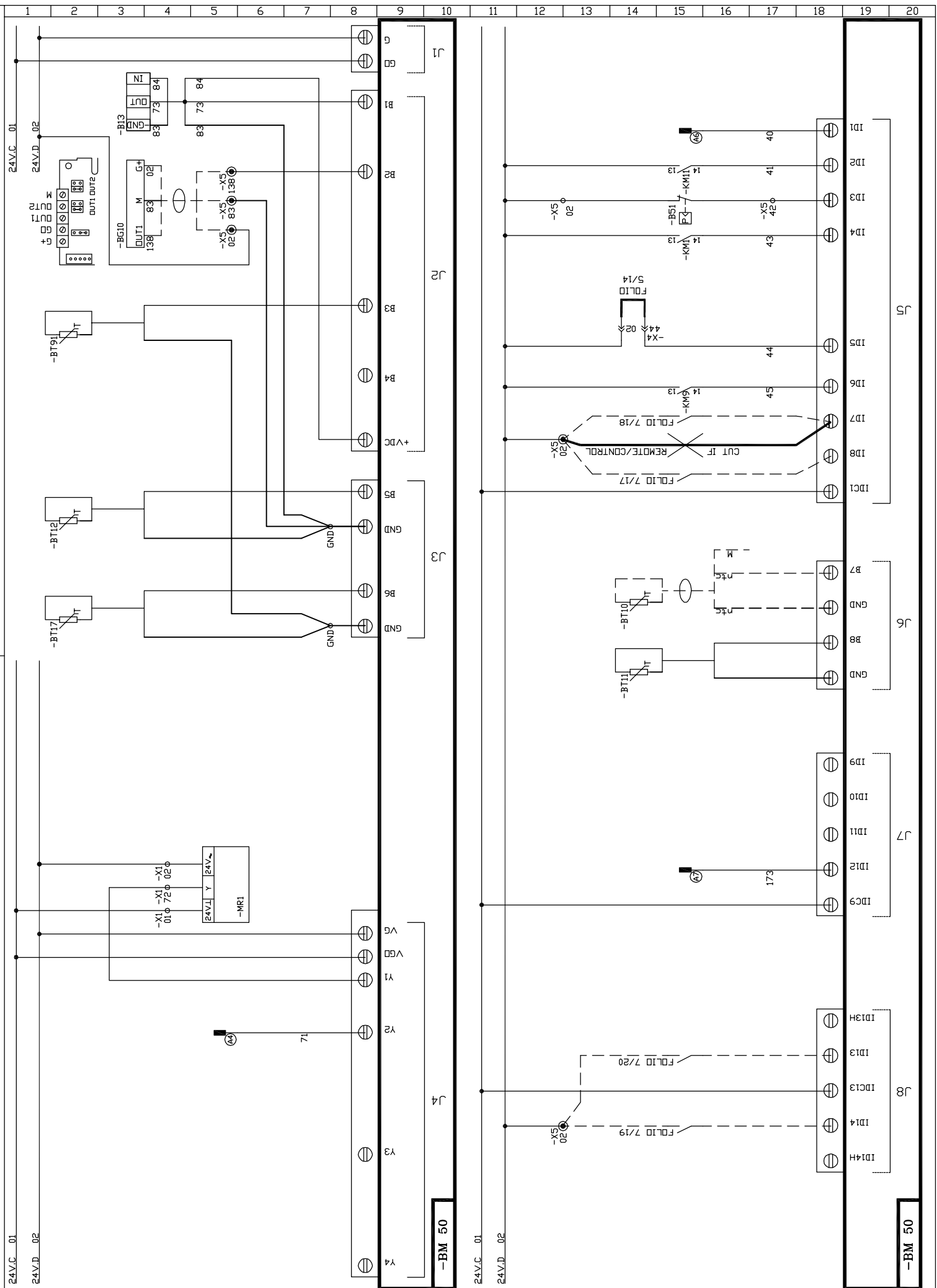

Indice	DATE	NOM	MODIFICATIONS

(1) BHK 020 NS
Entrées Automate CLIMATIC 50
Climatic 50 Controller Input

Dessine: T/Y
Date: 16.10.06



251030 3/11

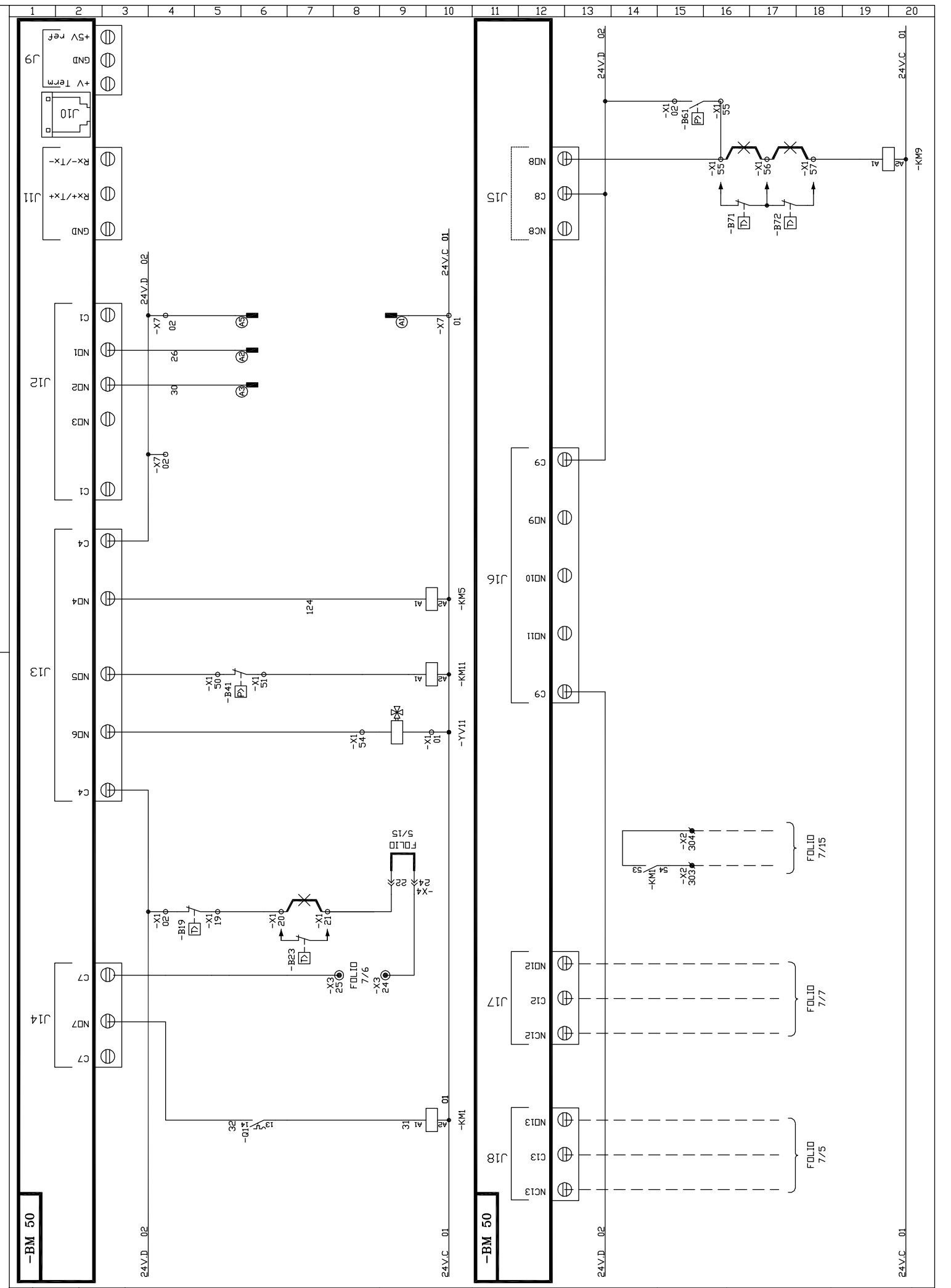

-BM 50

-BM 50

(1) BHK 020 NS
Sorties Automate CLIMATIC 50
Climatic 50 Controller Outputs

Dessine: T/Y
Date: 16.10.06



251030 4/11

Indice	DATE	NOM	MODIFICATIONS

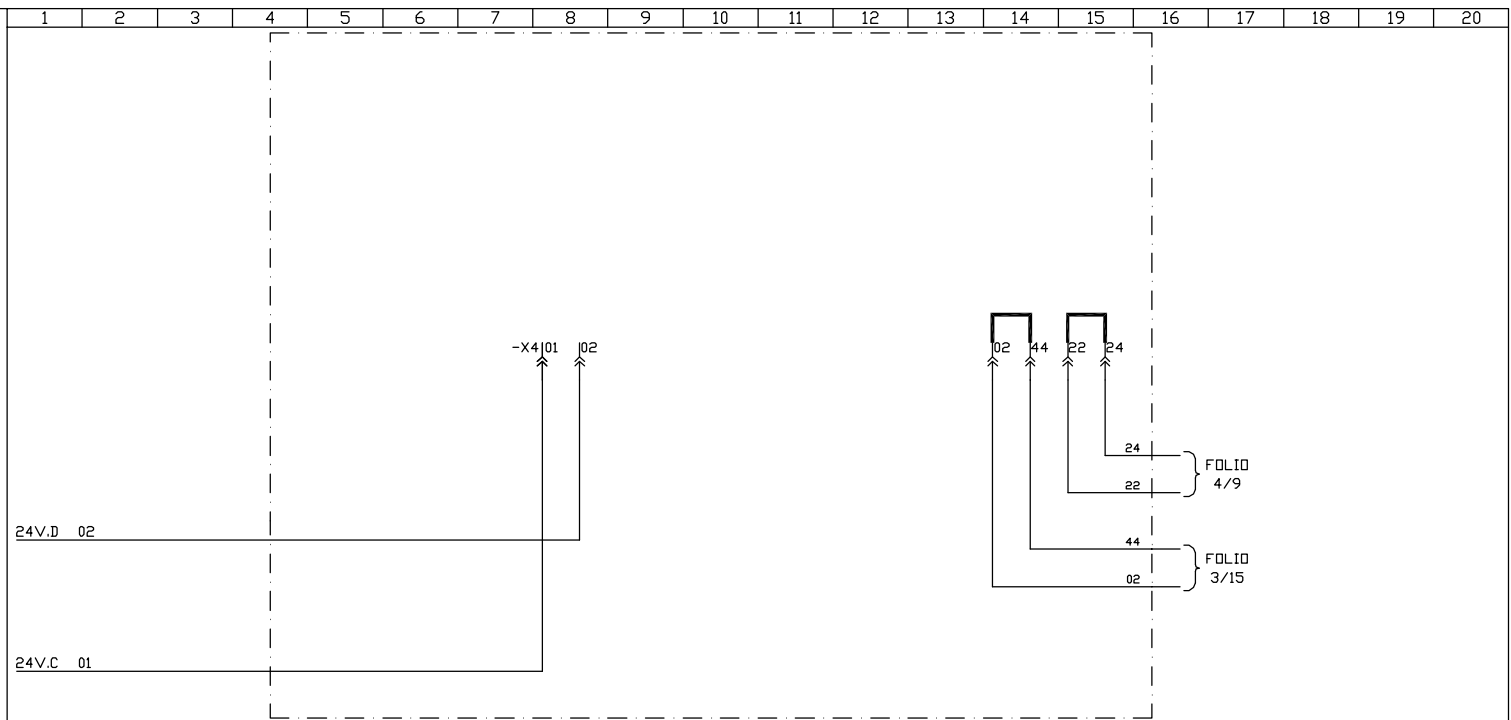



					(1) BHK 020 NS Kit chauffage GAS	Dessine: T/Y	 USINE DE LONGVIC	251030	6 / 11
Indice	DATE	NOM	MODIFICATIONS			Date: 16.10.06			

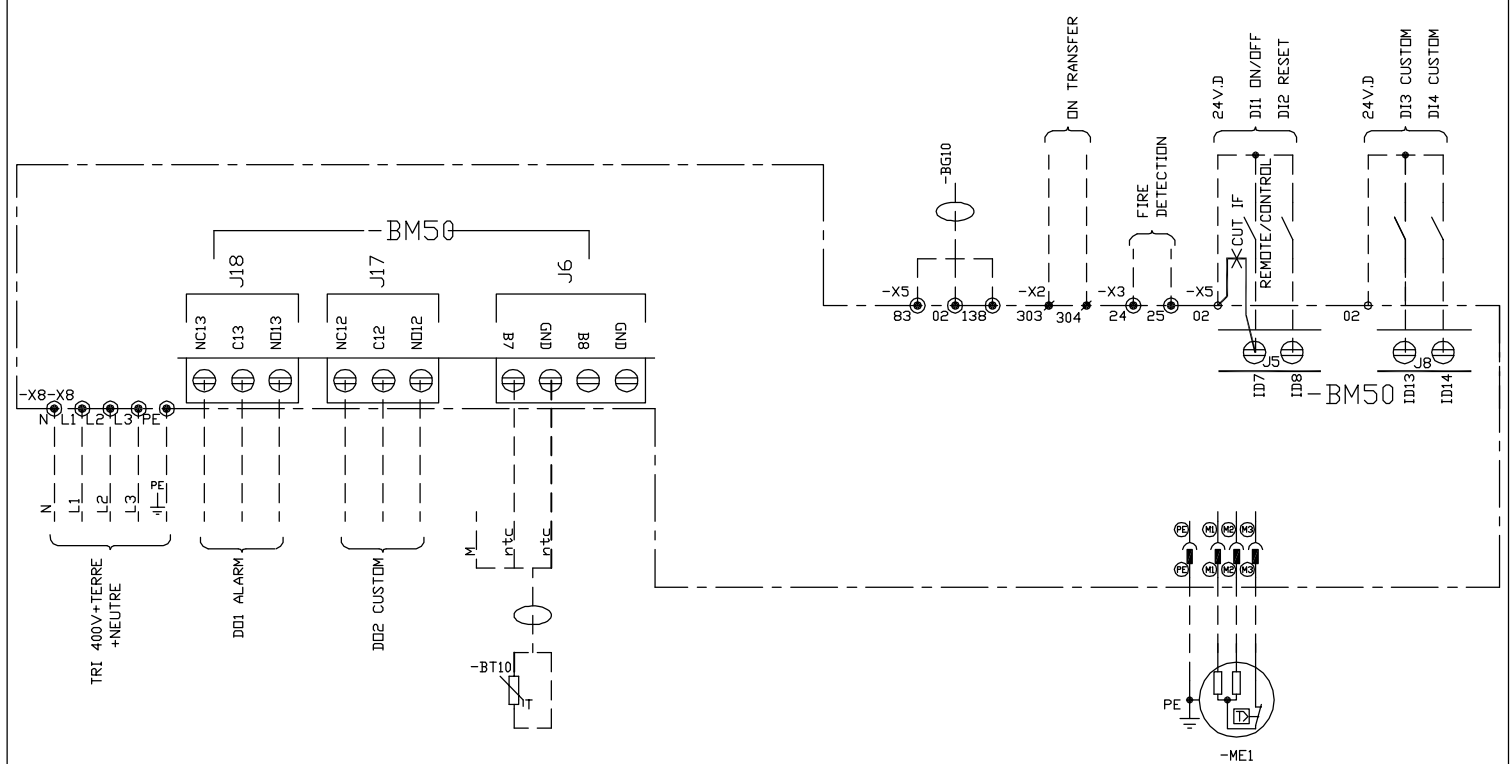
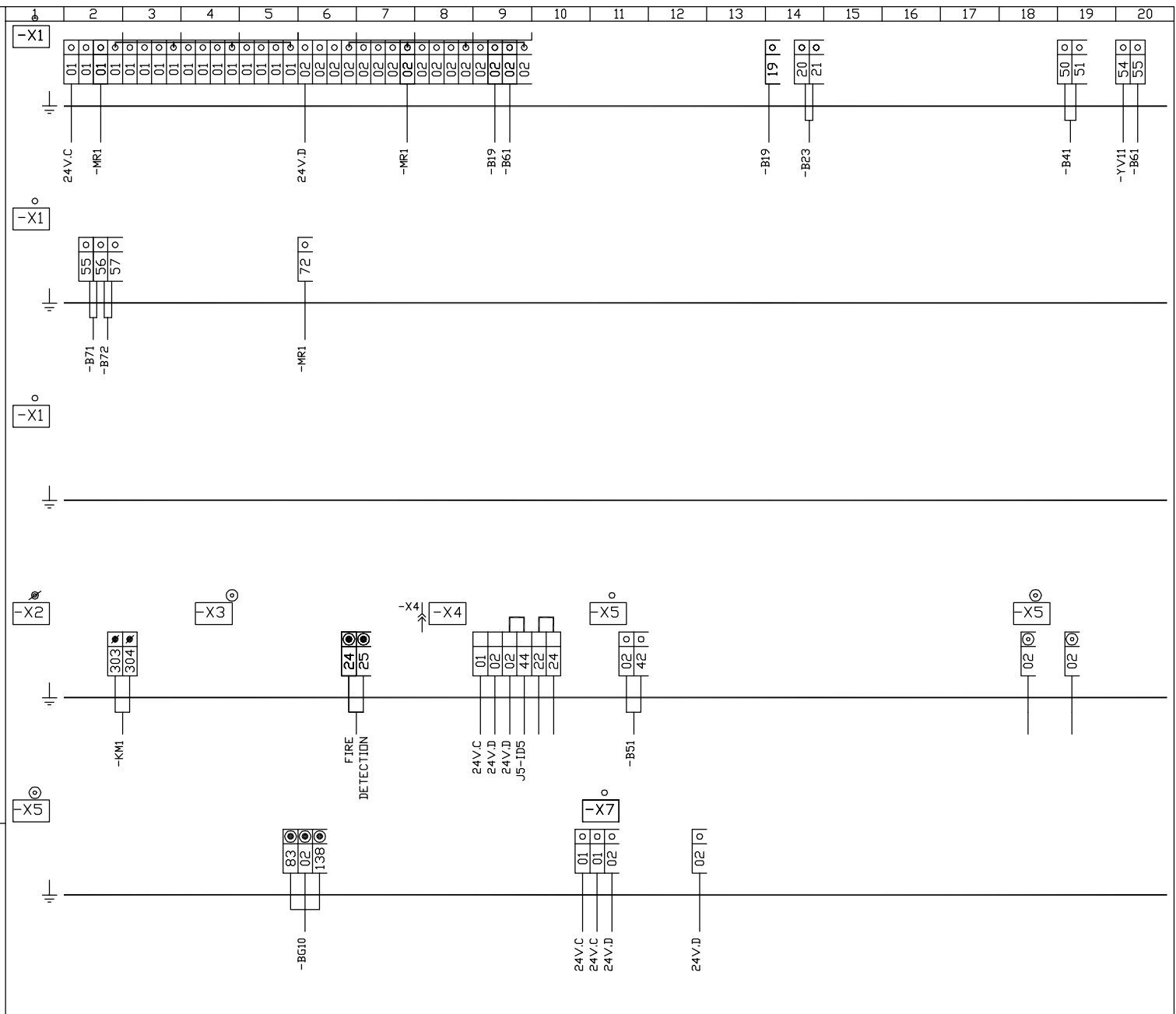

Indice	DATE	NOM	MODIFICATIONS

(1) BHK 020 NS
 Borniers \ Raccordement Client
 Terminal Strip \ Customer

Dessine: T/Y
 Date: 16.10.06



251030 7/11

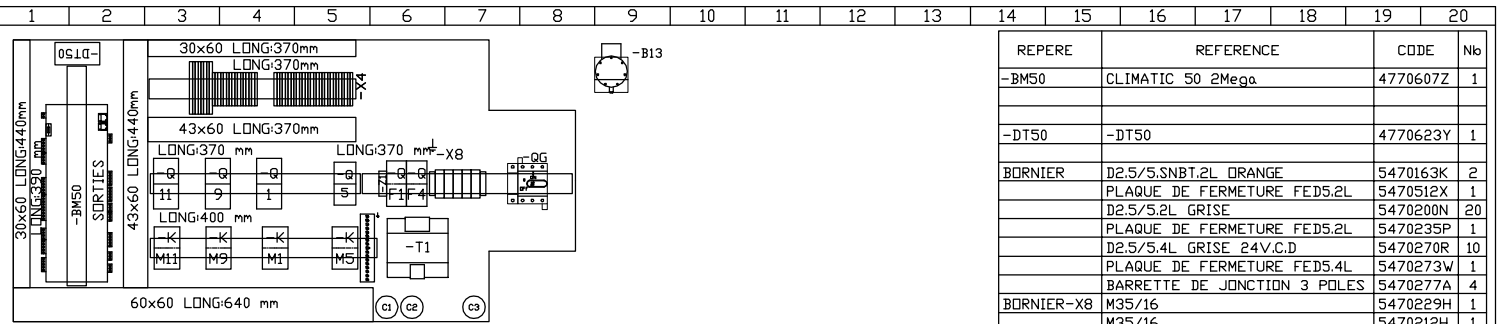

REPERE	REFERENCE	CODE	Nb
-QG	INTER DT 63 E3	4480657E	1
-QG	POLE NEUTRE DTPL 63 EP	4480677K	1
-QG	POIGNEE DE MANOEUVRE DHY2AJ	4480661L	1
-QG	ARBRE DE MANOEUVRE DXS 5x330	4480660J	1
PRDFIL	OMEGA 35x7.5x1.5 LONG:160mm	5740142E	1
BARRETTE	TYPE MG 14979	5470186T	1
-QF1	C60N 24583 4A BIPOL COURBE D	4480591H	1
-QF4	C60N 24584 6A BIPOL COURBE D	4480592J	1
-T1	160VA PRIMAIRE 400V /24V	4430121L	1
-B13	697 9500010A	4730097A	1
-B13	SUPPRT PLAN N 3172211A	4148197R	1
-Z1	LRC V2-0.22-220/400V	4770010X	1
-Q5	GV2 M14 6/10A	4410848T	1
-KM5	LC1 D09 B7	4410650A	1

REPERE	REFERENCE	CODE	Nb
-Q1	GV2 M20 13/18 A	4410850W	1
-Q1	GV2 AE 113	4410891J	1
-KM1	LC1 D12 B7	4410651E	1
-KM1	LA DN403	5410092V	1

REPERE	REFERENCE	CODE	Nb
-BM50	CLIMATIC 50 2Mega	4770607Z	1
-DT50	-DT50	4770623Y	1
BORNIER	D2.5/5.SNBT.2L DRANGE	5470163K	2
	PLAQUE DE FERMETURE FED5.2L	5470512X	1
	D2.5/5.2L GRISE	5470200N	20
	PLAQUE DE FERMETURE FED5.2L	5470235P	1
	D2.5/5.4L GRISE 24V.C.D	5470270R	10
	PLAQUE DE FERMETURE FED5.4L	5470273W	1
	BARRETTE DE JONCTION 3 POLES	5470277A	4
BORNIER-X8	M35/16	5470229H	1
	M35/16	5470212H	1
	M35/16	5470204V	3
	PLAQUE DE FERMETURE	5470237T	1
BUTEE	BARRETTE BUTEE JONCTION 2 POLES	5470276X	2
-Q11	GV2 M22 20/25 A	4410852Y	1
-KM11	LC1 D18 B7	4410652F	1
-Q9	GV2 M14 6/10A	4410848T	1
-C1-2	7micro farad	4921048M	2
-KM9	LC1 D09 B7	4410650A	1

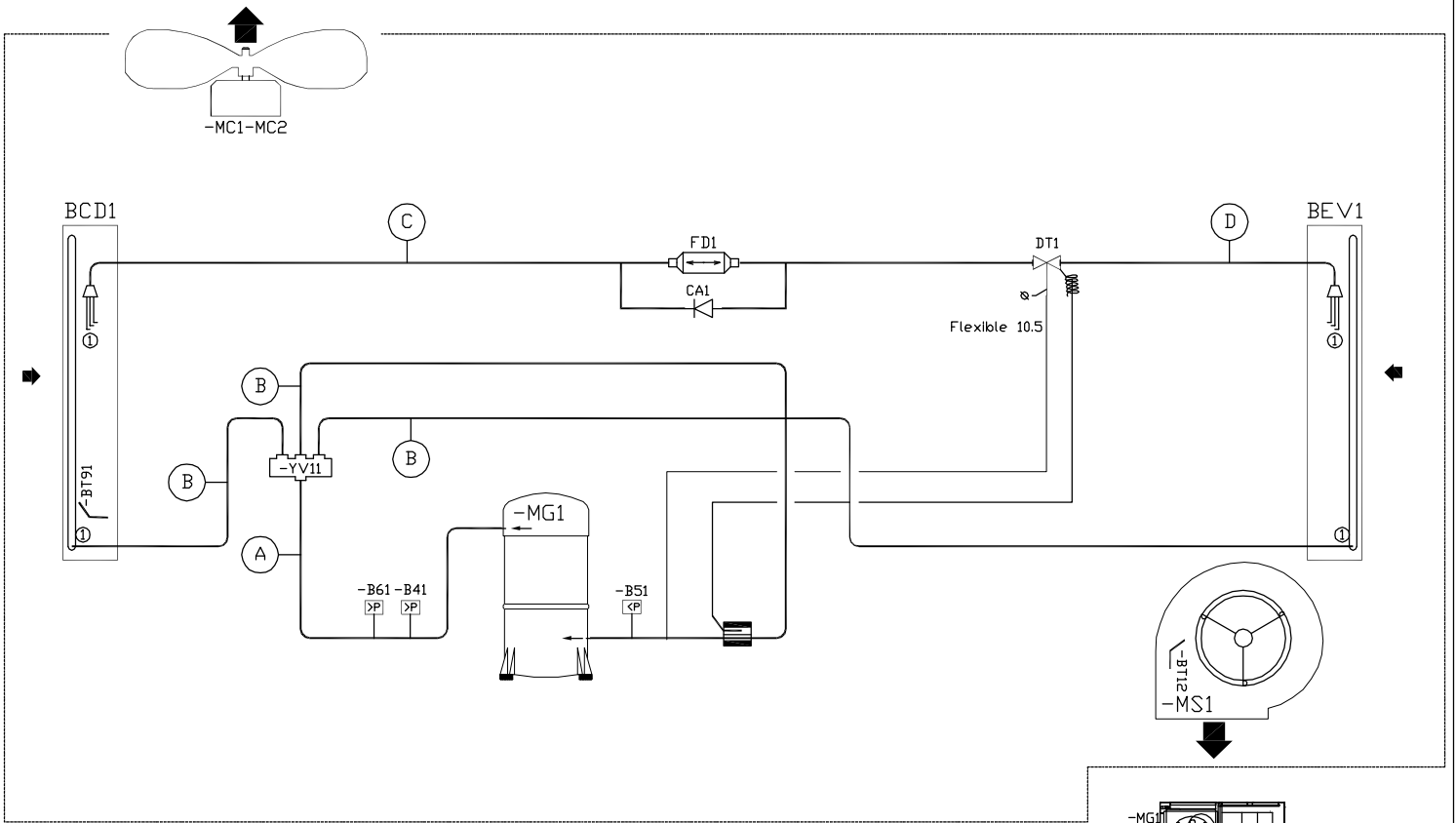

BOX	20/25
D	5/8"
C	1/2"
B	1 1/8"
A	7/8"

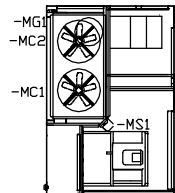

(1) BHK 020 NS
 Schéma Frigorifique \ Hydraulique
 Cooling \ Hydraulic Diagram

Dessine: T/Y
 Date: 16.10.06

LENNOX
 USINE DE LONGVIC

251030 9/11

Indice	DATE	NOM	MODIFICATIONS

