

Indice	DATE	NOM	MODIFICATIONS
			
Meeting Hall - Swindon			
(1) BGK 060 HD LENNOX UK	Dessine: CTO Date: 06.11.07	PAGE DE GARDE	138023 0/11

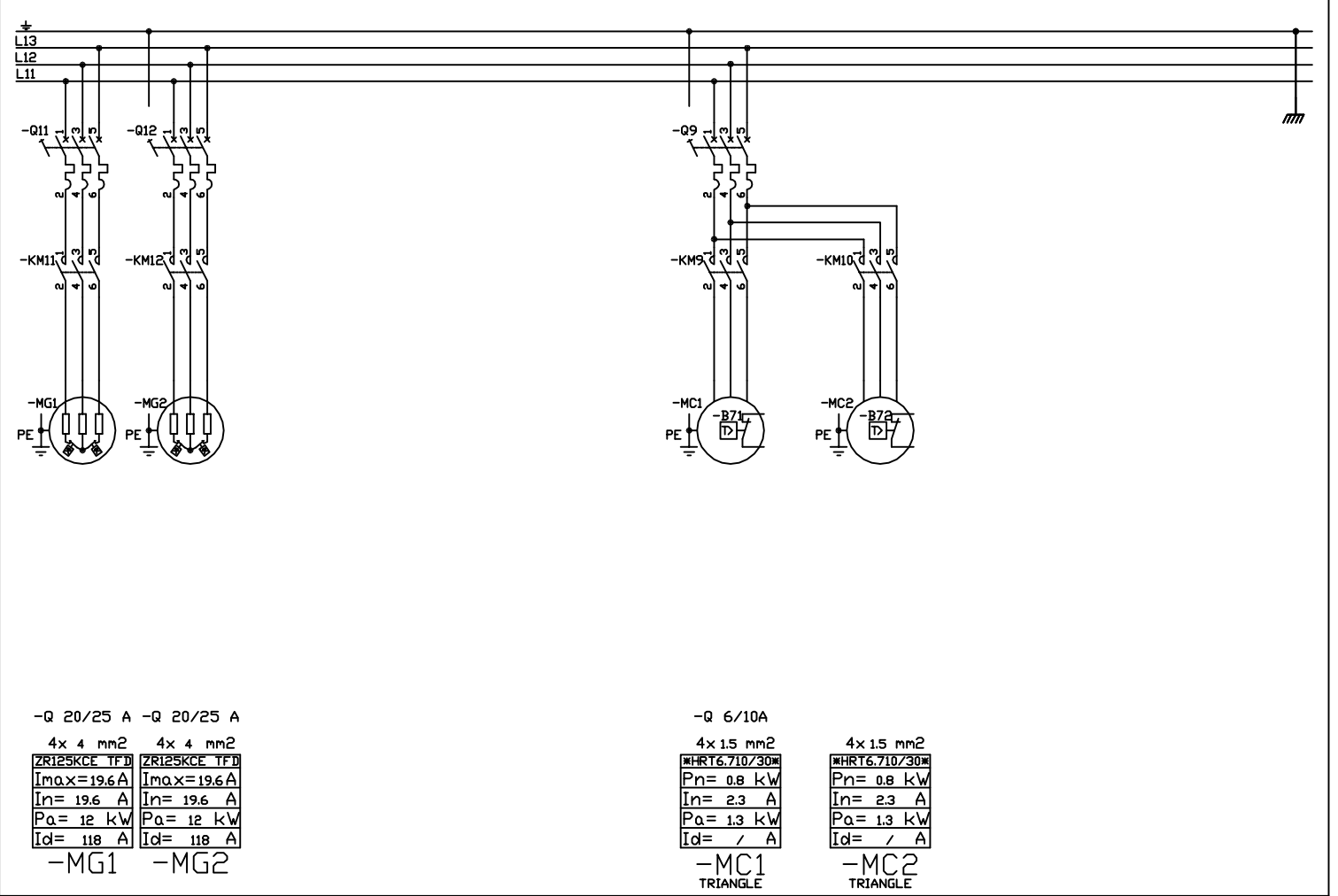

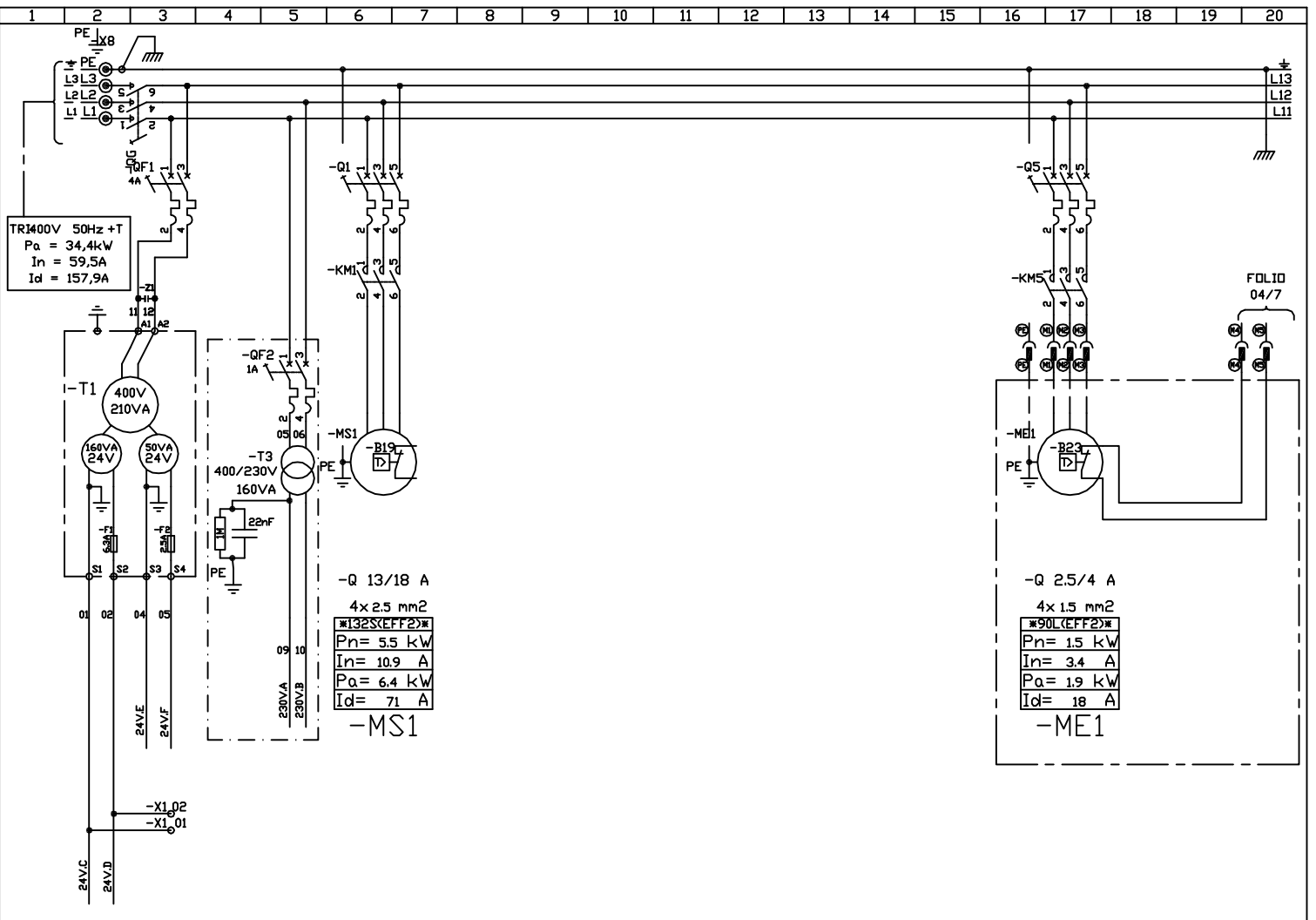

- BM 50

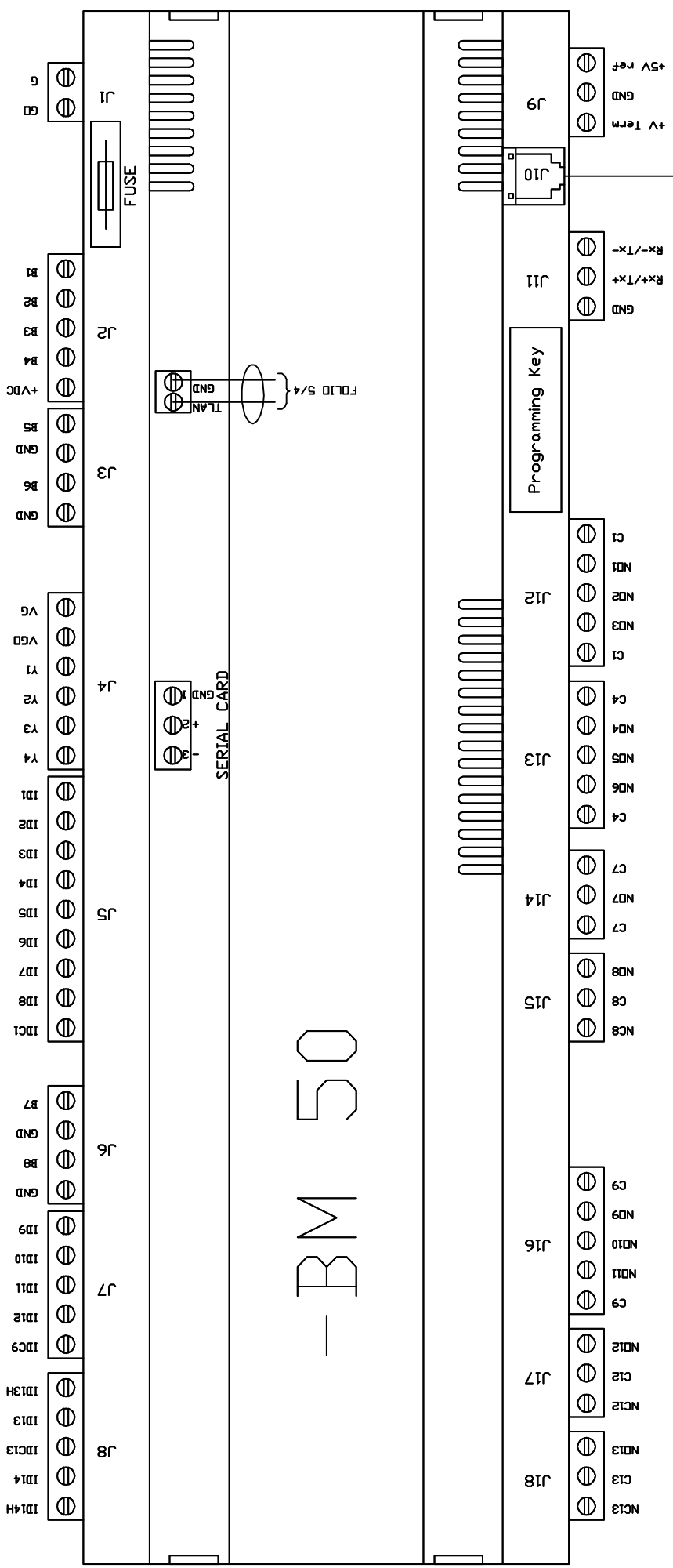
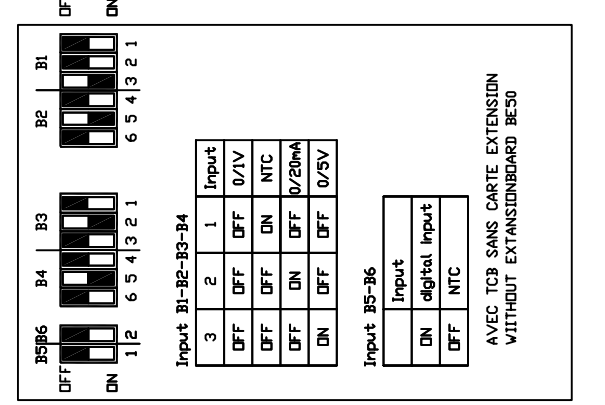
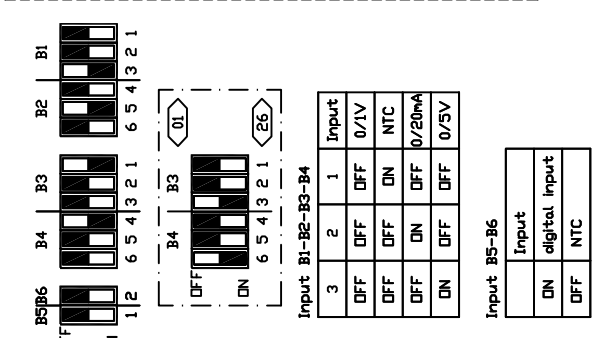
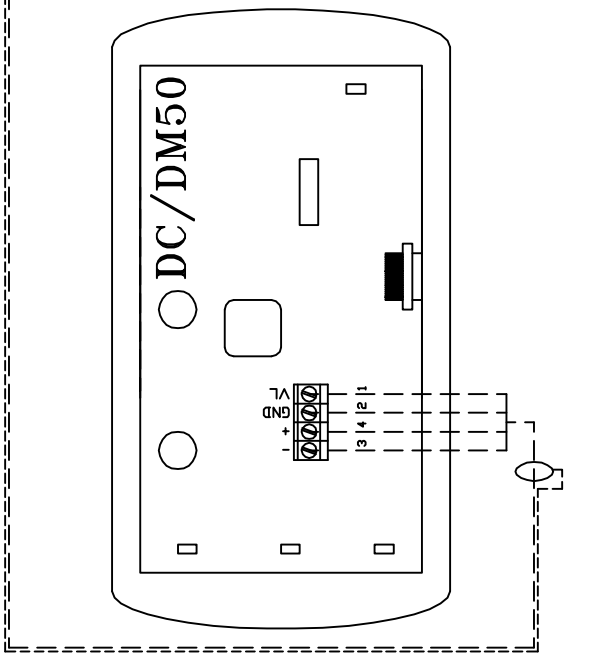
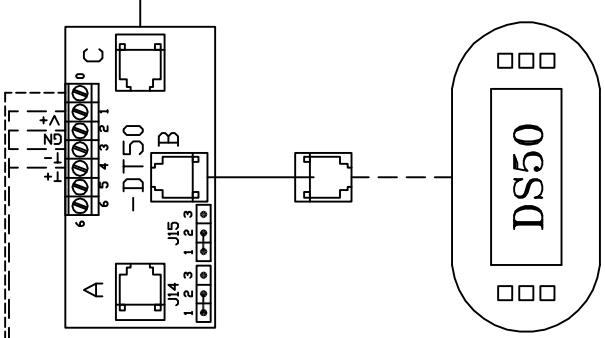

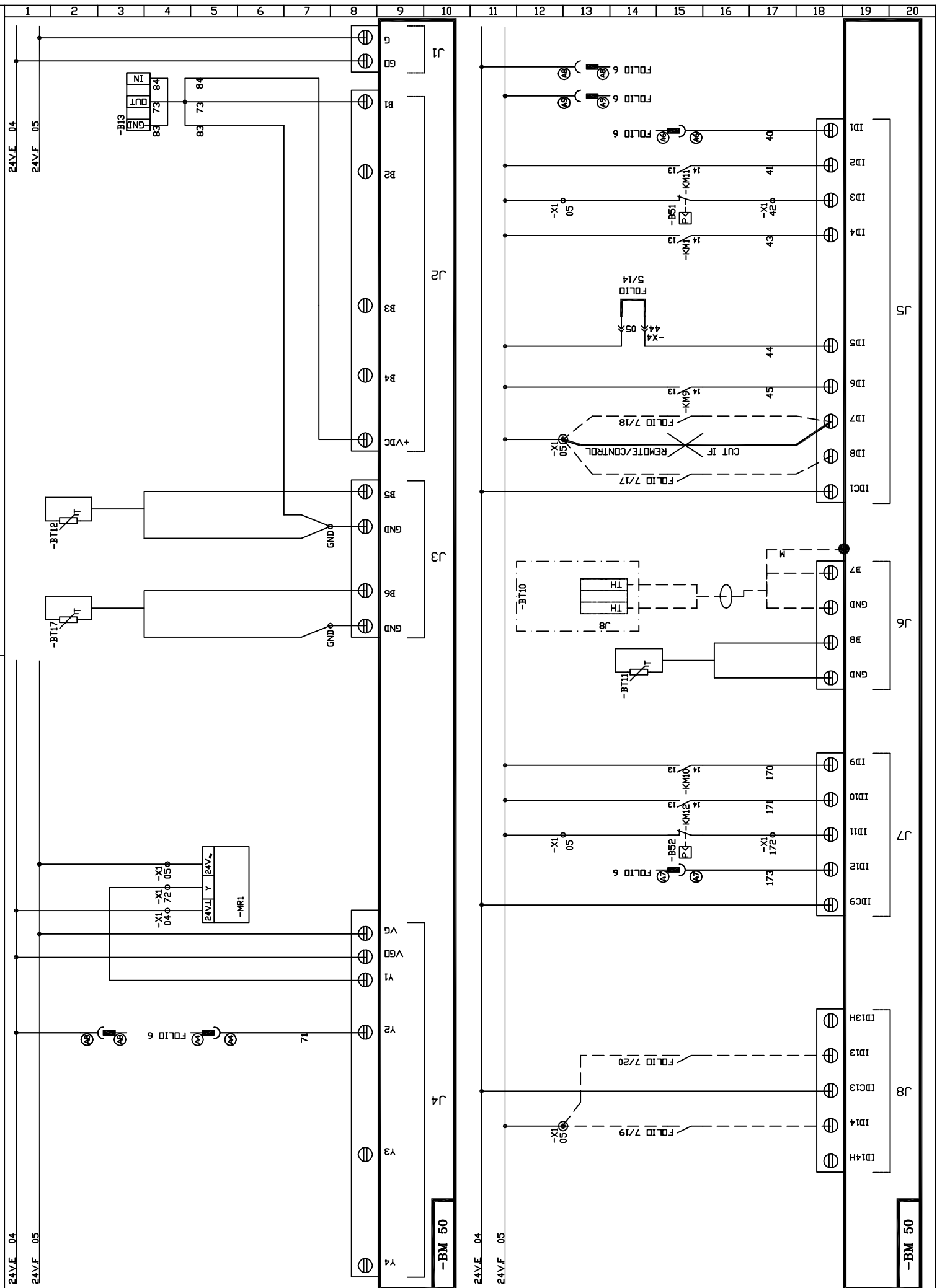

Indice	DATE	NOM	MODIFICATIONS

(1) BCK 060 HD
Entrées Automate CLIMATIC 50
Climatic 50 Controller Input

Dessine: CTO
Date: 06.11.07



138023 3/11

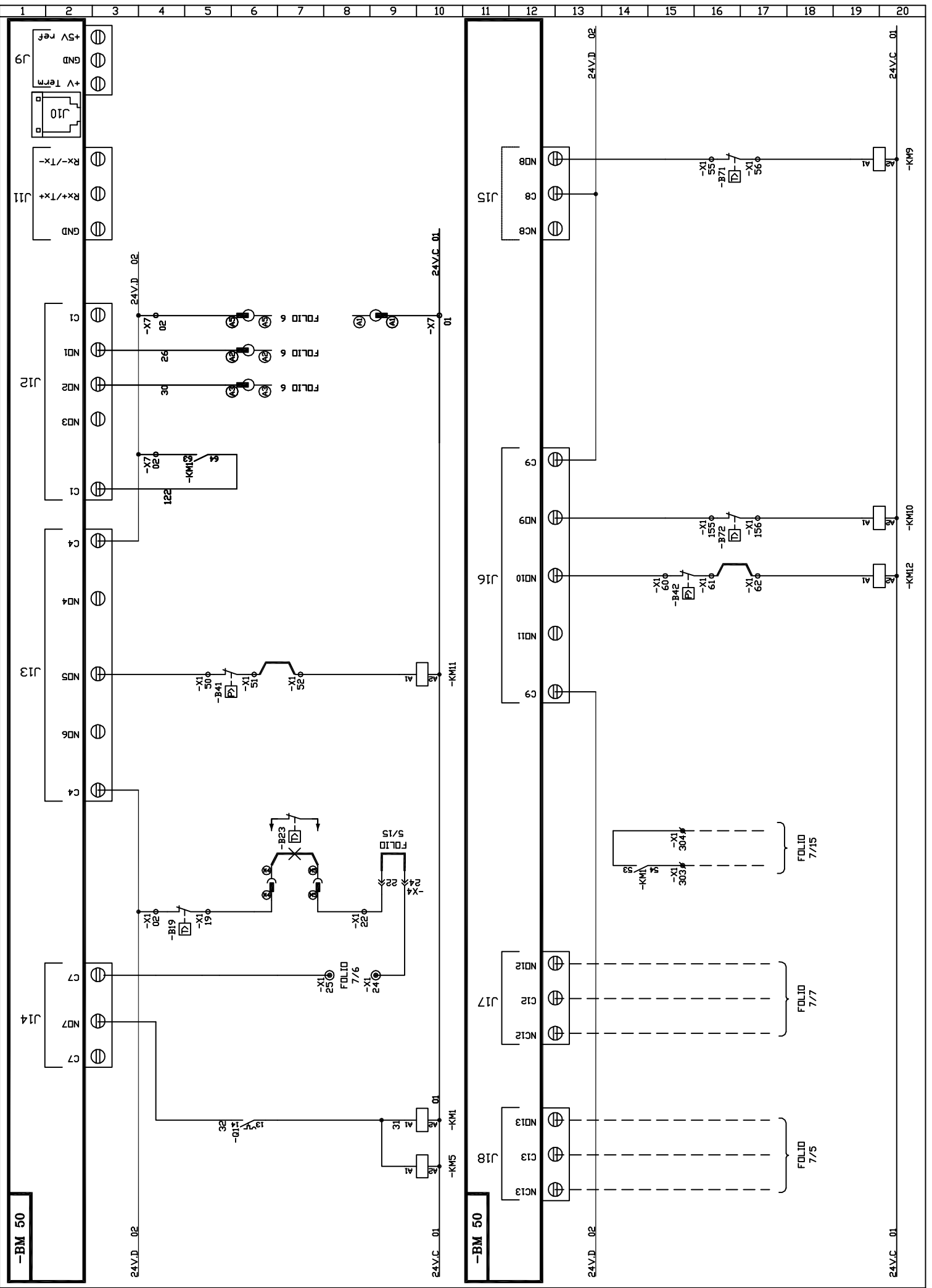

Indice	DATE	NOM	MODIFICATIONS

(1) BCK 060 HD
Sorties Automate CLIMATIC 50
Climatic 50 Controller Outputs

Dessine: CTO
Date: 06.11.07



138023 4/11

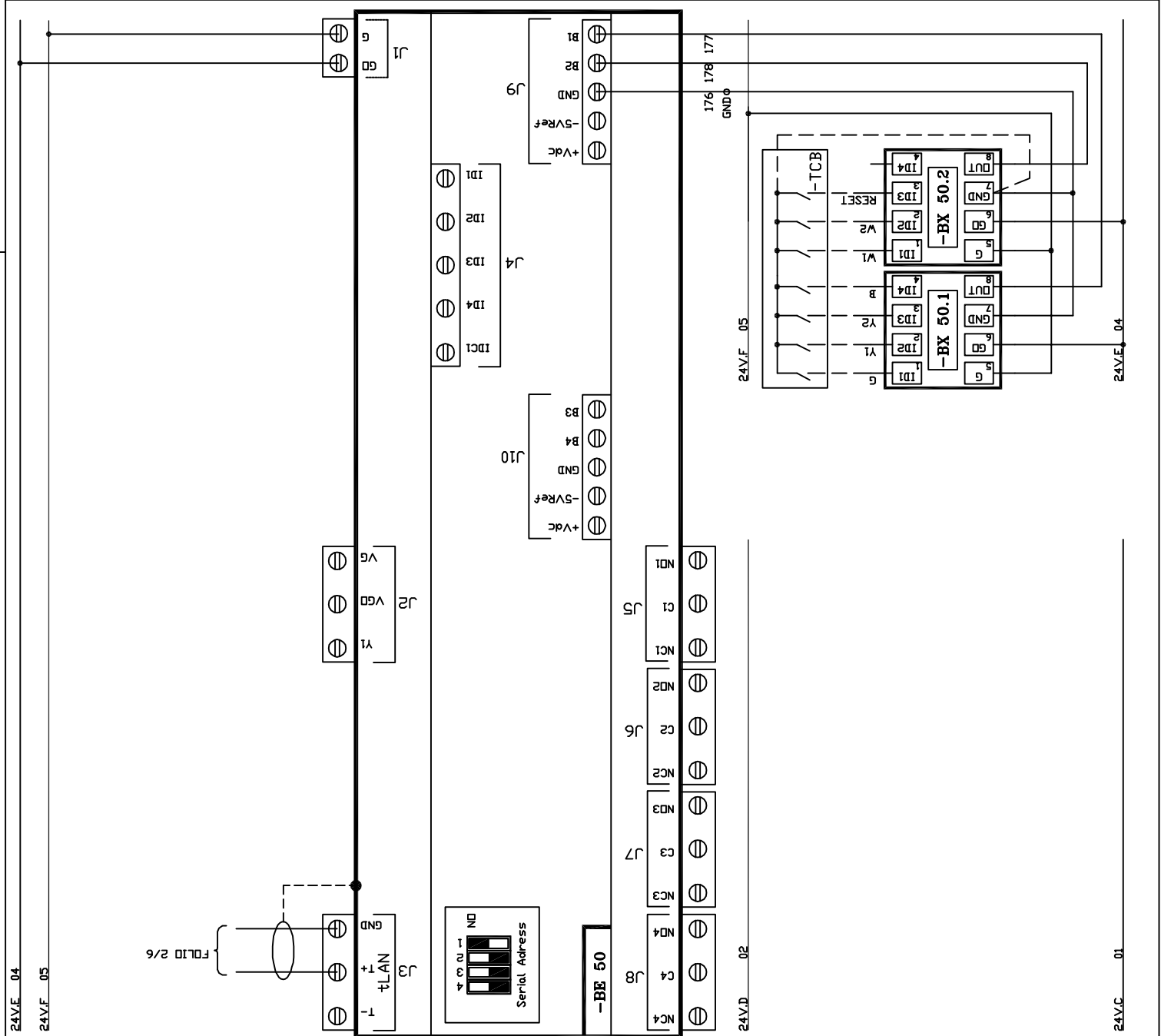
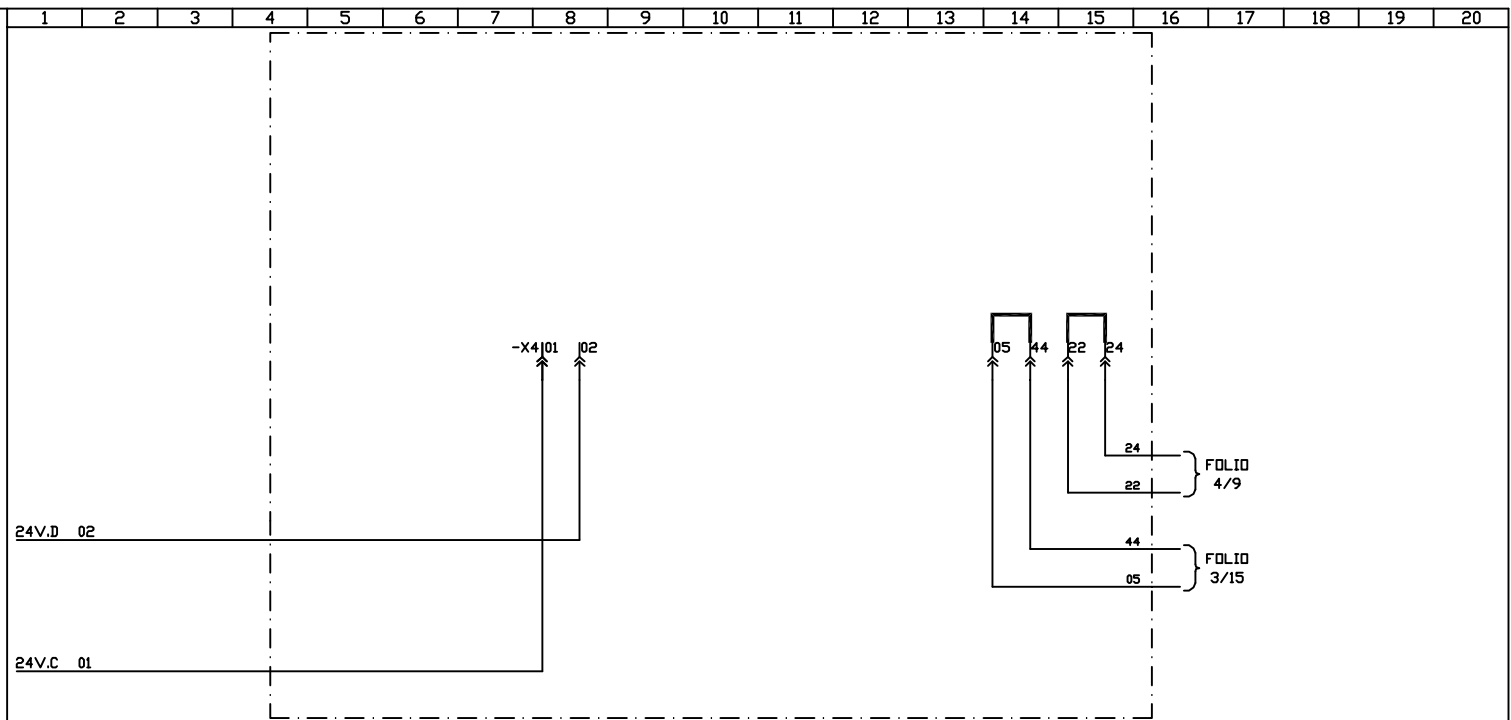

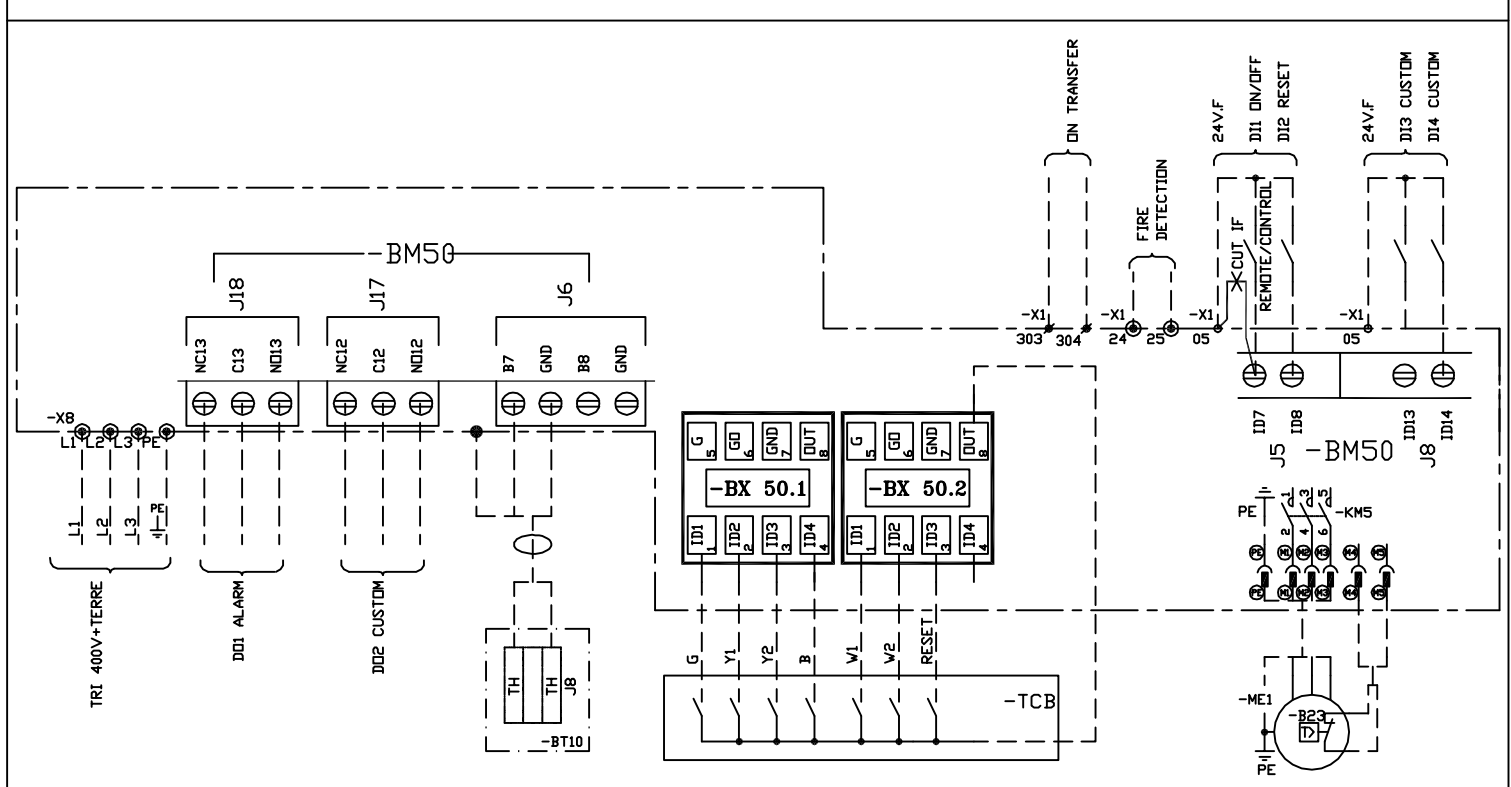
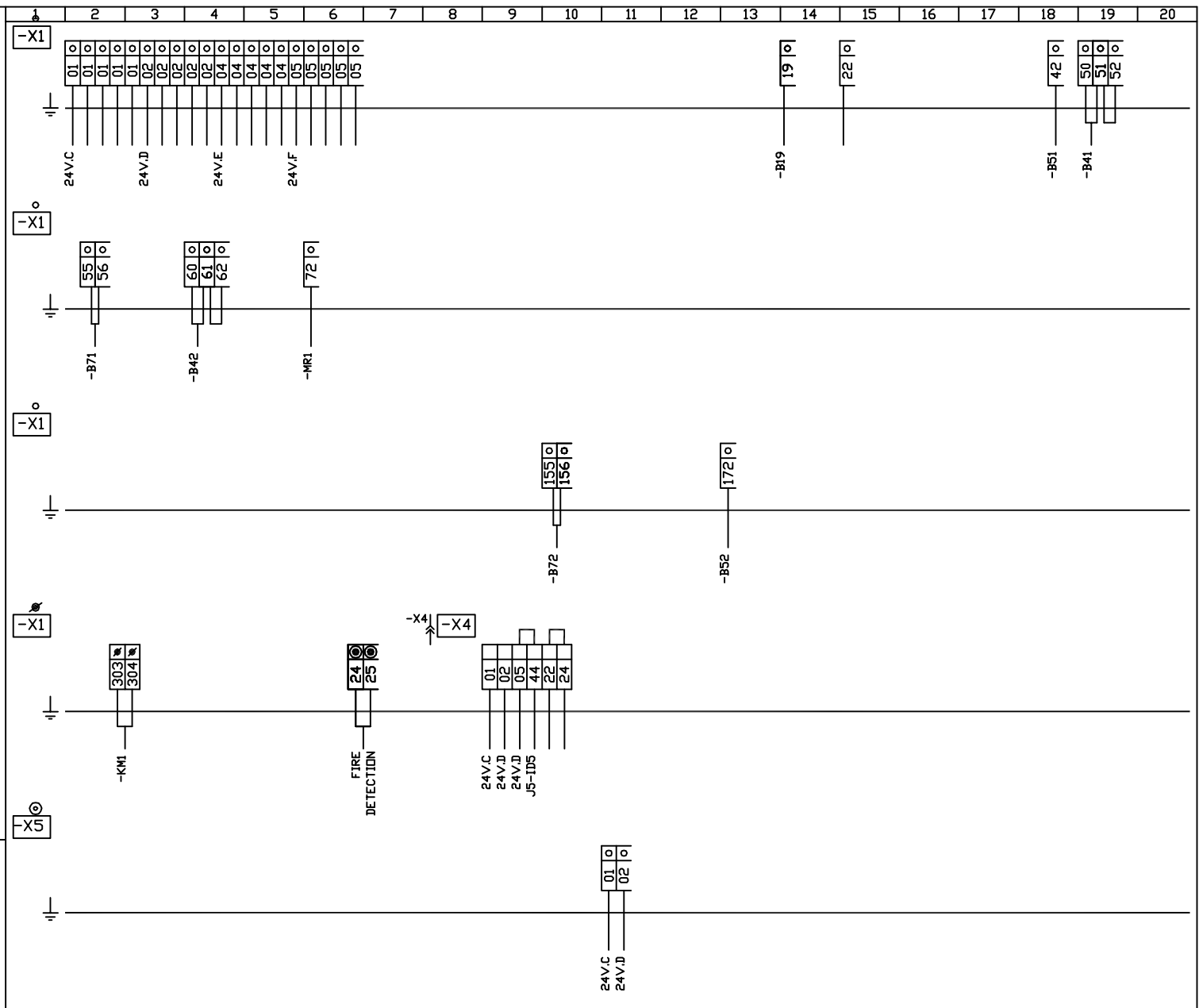

Indice	DATE	NOM	MODIFICATIONS

(1) BCK 060 HD
 Borniers \ Raccordement Client
 Terminal Strip \ Customer

Dessine: CTO
 Date: 06.11.07



138023 7/11

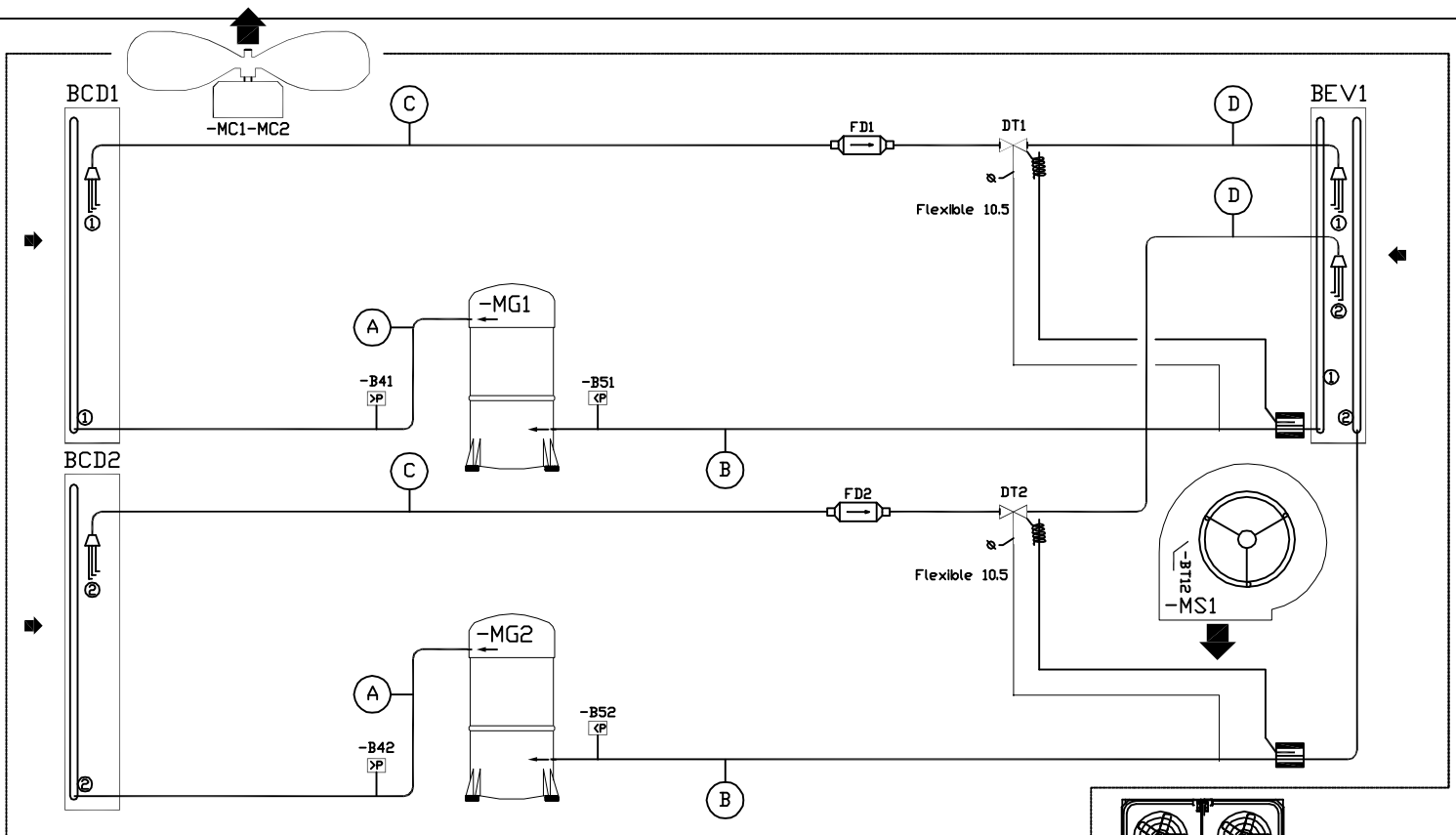

BOX	30/35	40	-MG1	45	-MG2	50	60	70
D	5/8"	5/8"	5/8"	7/8"	7/8"	7/8"	7/8"	7/8"
C	1/2"	1/2"	1/2"	5/8"	5/8"	5/8"	5/8"	5/8"
B	7/8"	1 1/8"	1 1/8"	1 1/8"	1 1/8"	1 3/8"	1 3/8"	1 3/8"
A	5/8"	7/8"	7/8"	7/8"	7/8"	7/8"	7/8"	7/8"

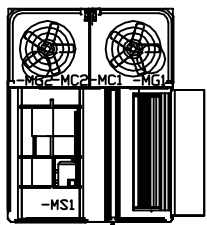

Indice	DATE	NOM	MODIFICATIONS

(1) BCK 060 HD
 Schéma Frigorifique \ Hydraulique
 Cooling \ Hydraulic Diagram

Dessine: CTO
 Date: 06.11.07



138023 9/11

