

ELEMENTOS OPCIONALES / OPTIONAL ELEMENTS

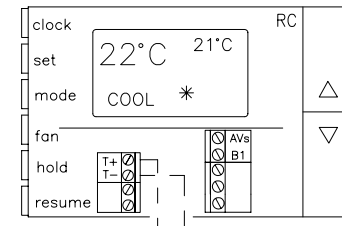

Nota1: Eliminar puente cuando se instale el opcional
 Note1: Remove jumper when installing the optional
 Note1: Enlevez le pont en cas d'installer optional
 Notiz1: Entfernen sie die jumper falls optional angebrochen ist

CONEXIONES ELECTRICAS / ELECTRICAL CONNECTIONS

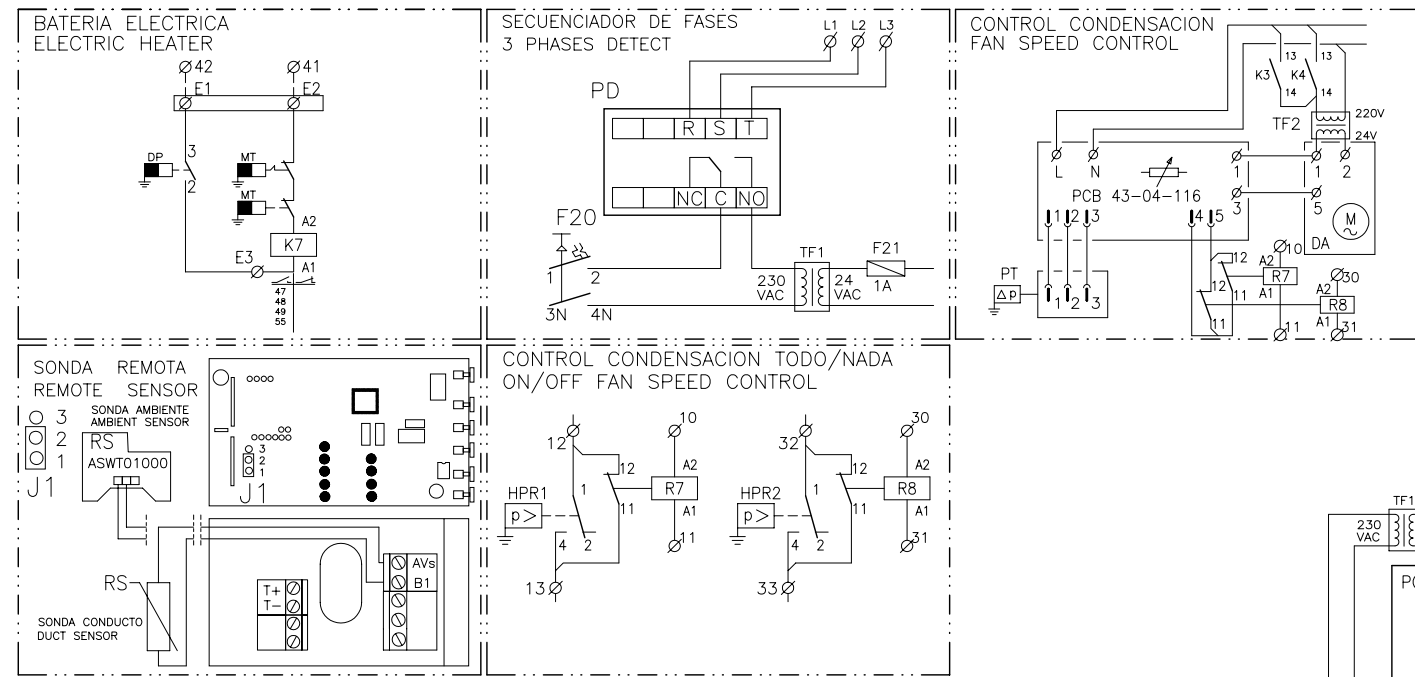
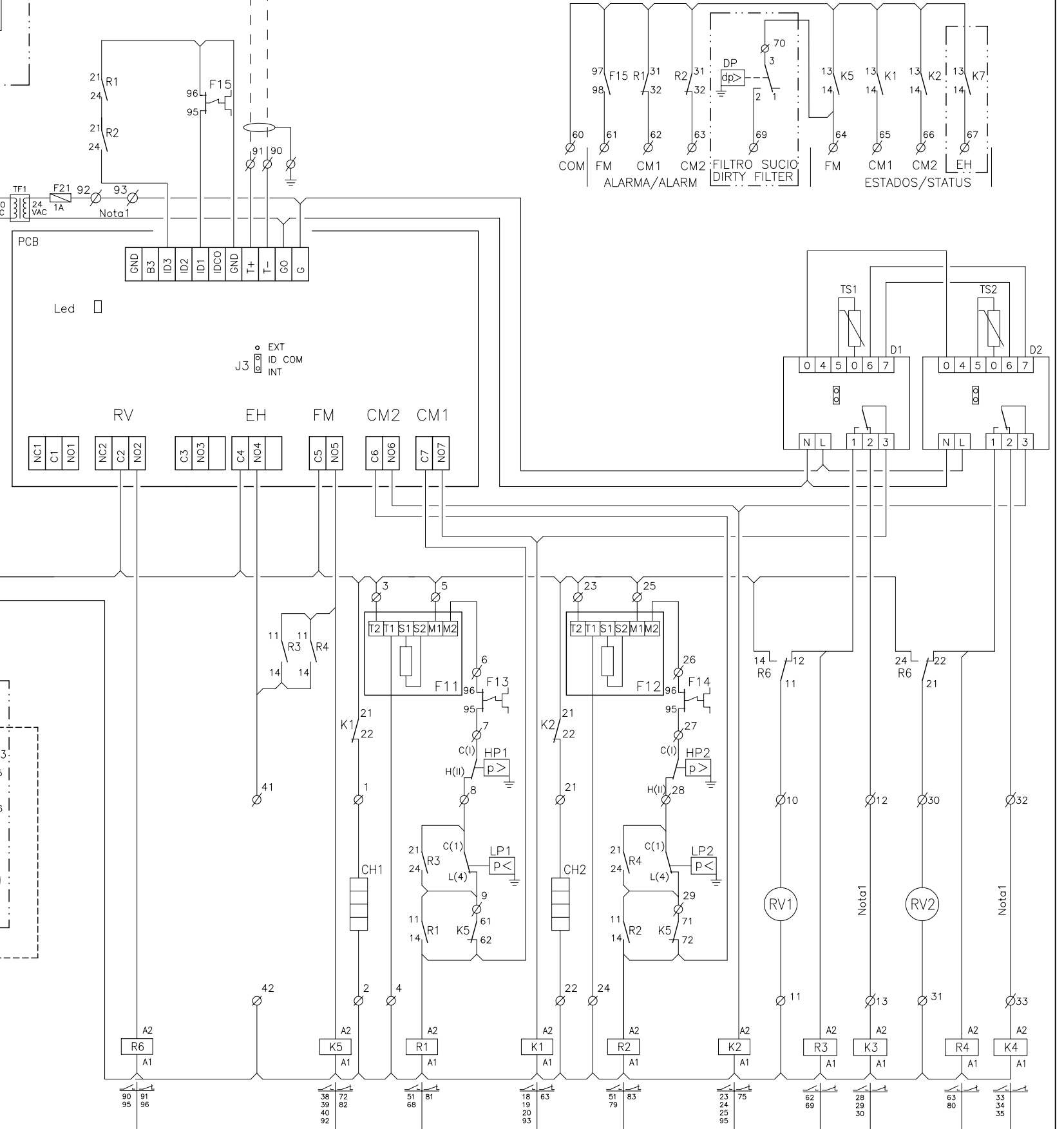
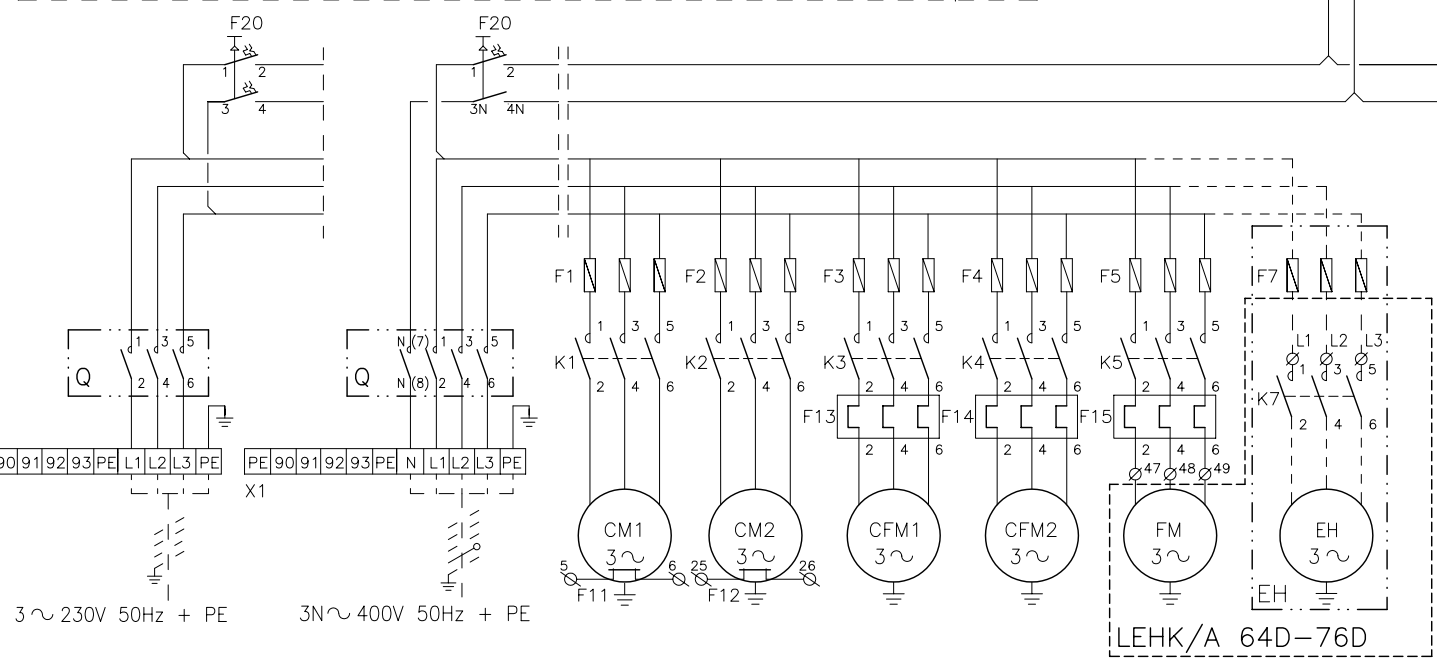
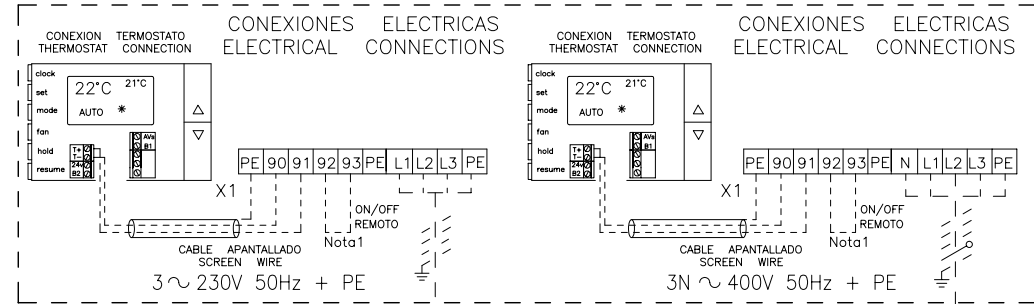

Elemento Opcional / Optional Element	-----
A Realizar por el Instalador / To Wire by the Installer	-----
Fusibles / Fuses size	F1 - F2 / F3-F4-F5
230/3/50	2x 3 x 50A / 2x 3 x 63A / 3x 3 x 16A
400/3/50	2x 3 x 25A / 2x 3 x 32A / 3x 3 x 10A