

ELEMENTOS OPCIONALES / OPTIONAL ELEMENTS

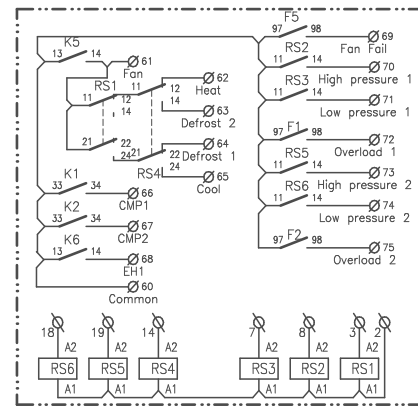

- CFM Motor Ventilador Exterior Condenser Fan Motor
- CH Calentador de C?rter Crank Case Heater
- CM Motor del Compresor Compressor Motor
- EH Bater?a El?ctrica Electric Heater
- F Protecci?n T?rmica Thermal Protection
- F6 Magnetot?rmico Circuitbreaker
- FM Motor Ventilador Interior Internal Fan Motor
- HP Presostato de Alta High Pressure Pressostat
- IP Placa Indicadores Indicators Plate
- K Contactor Contactor
- LP Presostato de Baja Low Pressure Pressostat
- MT Termostato de Seguridad Security Thermostat
- PCB Placa Circuito Impreso Printed Circuit Board
- RC Control Remoto Remote Control
- RV V?lvula Inversora Reverse Valve
- SC Cambio de Secuencia Sequence Change
- TD Temporizador de Desescarche Timer Defrost
- TR Temporizador Timer Delay

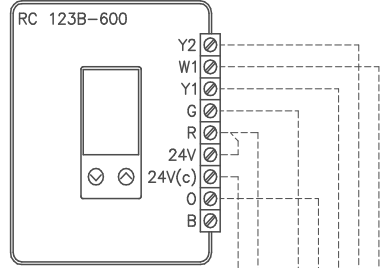
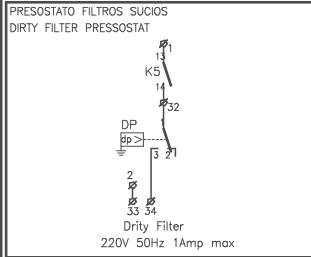
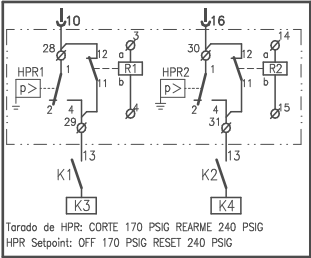
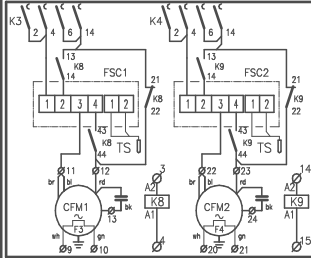
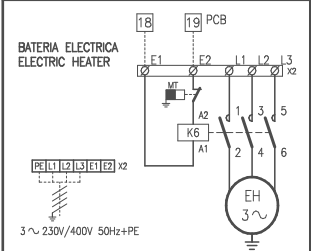
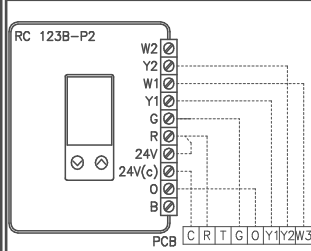

KAB 15D-17D-20D-30D

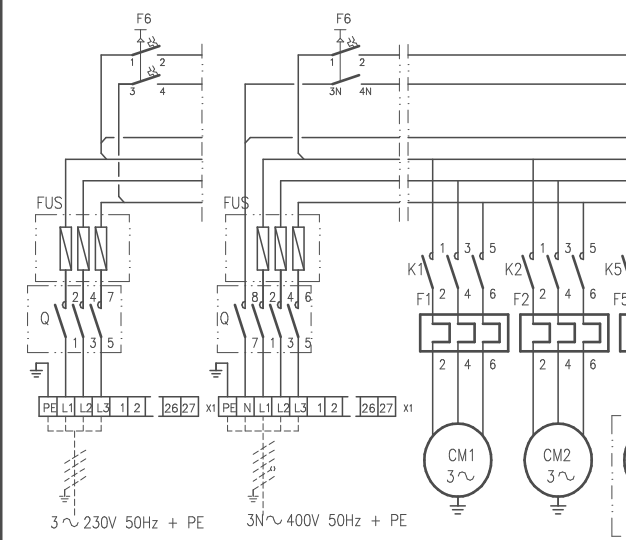
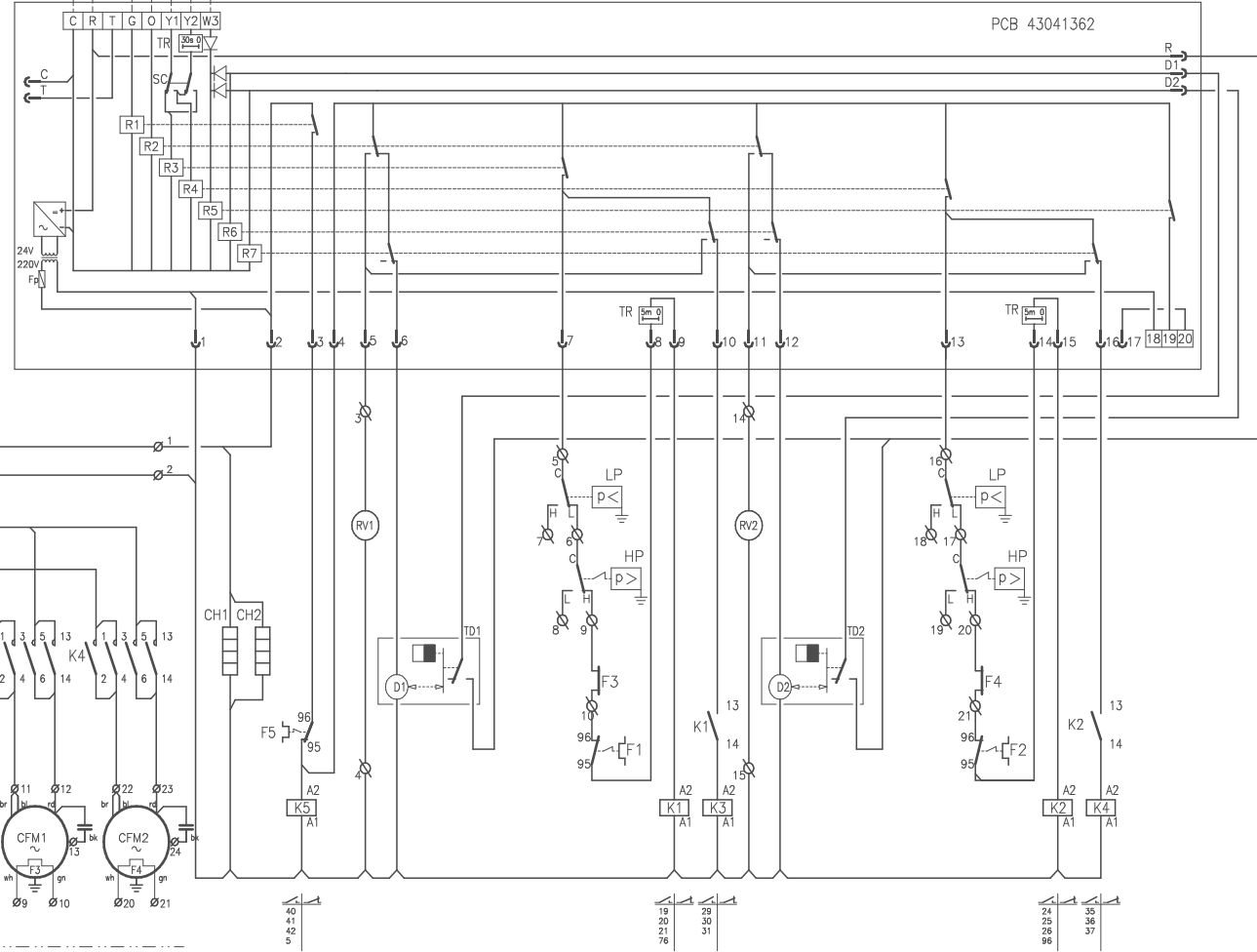

Elemento Opcional
Optional Element
A Realizar por el Instalador
To Wire by the Installer