

ELEMENTOS OPCIONALES / OPTIONAL ELEMENTS

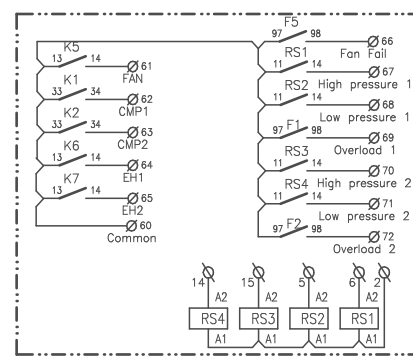

- | | | |
|-----|---------------------------------|--------------------------|
| CFM | Motor Ventilador Exterior | Condenser Fan Motor |
| CH | Calentador de C?rter | Crank Case Heater |
| CM | Motor del Compresor | Compressor Motor |
| EH | Bater?a El?ctrica | Electric Heater |
| F | Protecci?n T?rmica | Thermal Protection |
| F6 | Magnetol?rmico | Circuitbreaker |
| FM | Motor Ventilador Interior | Internal Fan Motor |
| HP | Presostato de Alta | High Pressure Pressostat |
| HPR | Presostato Control Condensaci?n | High Pressure Regulator |
| K | Contacto | Contact |
| LP | Presostato de Baja | Low Pressure Pressostat |
| MT | Termostato de Seguridad | Security Thermostat |
| PCB | Placa Circuito Impreso | Printed Circuit Board |
| RC | Control Remoto | Remote Control |
| SC | Cambio de Secuencia | Sequence Change |
| TR | Temporizador | Timer Delay |
| RS | Rel? de sealizaci?n | Signal Relay |
| FUS | Fusibles | Fuses |
| Q | Interruptor general | Main switch |

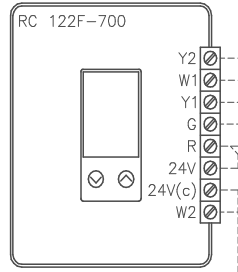
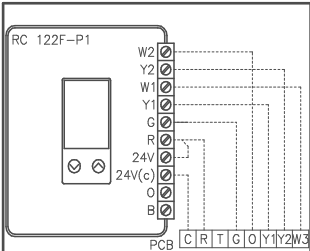
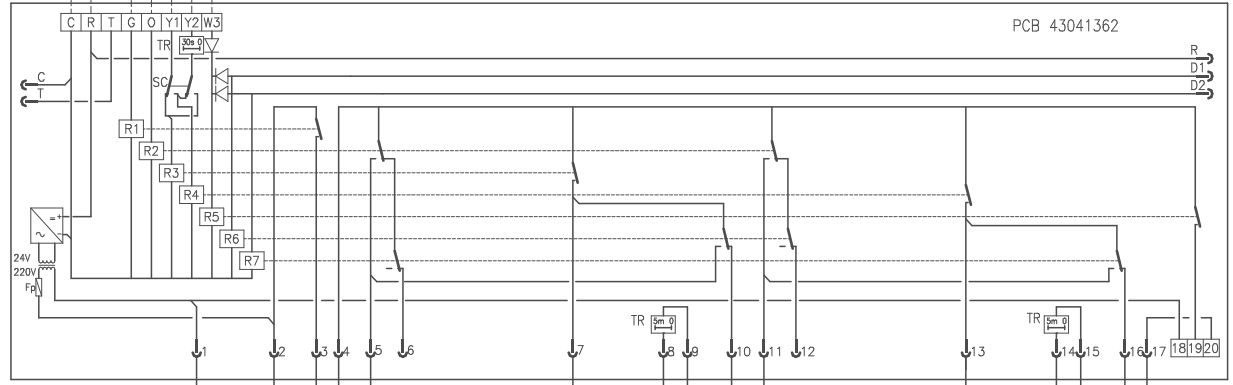
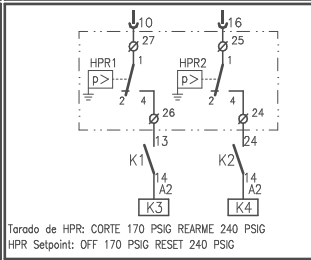
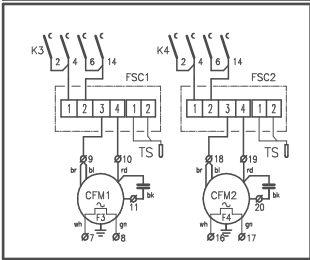
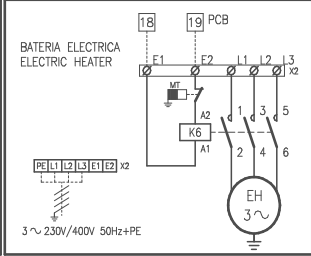
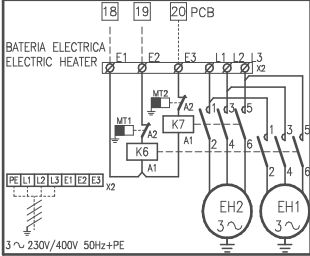

KNA 15D-17D-20D-30D

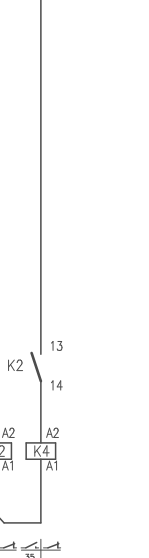
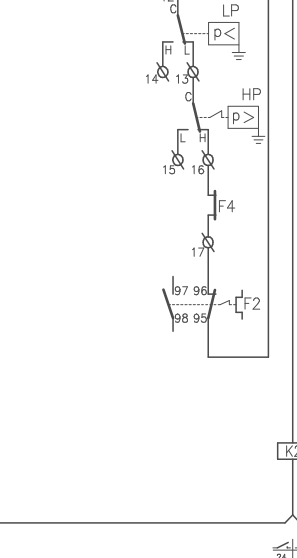
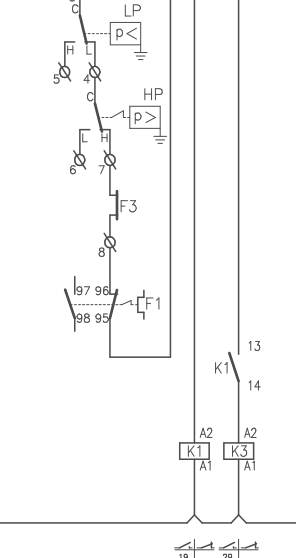
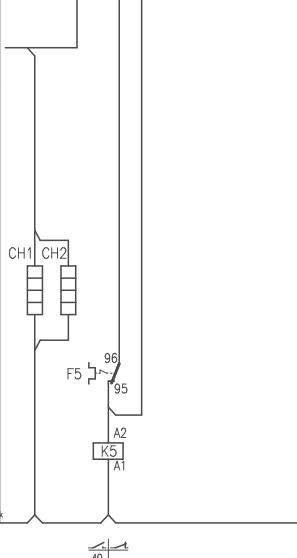
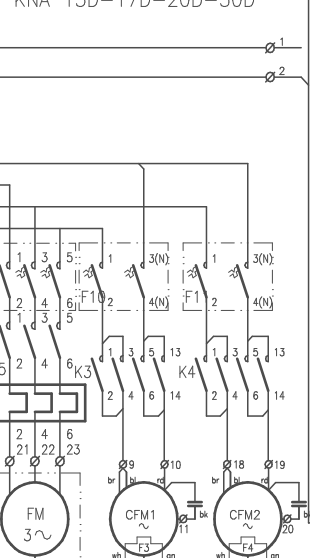
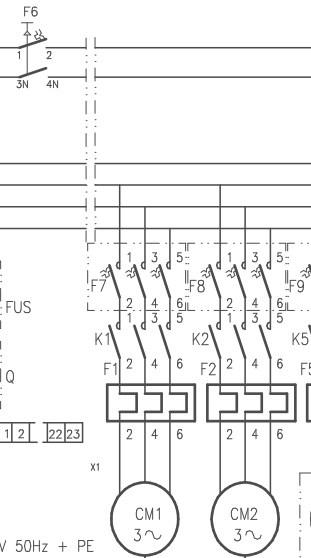
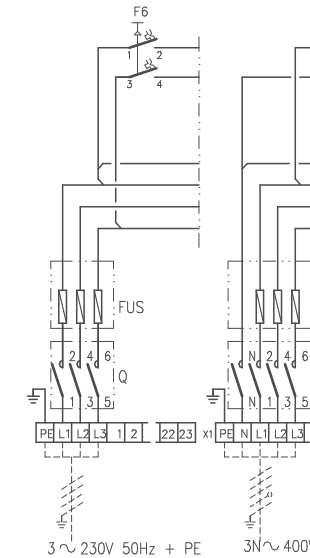

Elemento Opcional
Optional Element
A Realizar por el Instalador
To Wire by the Installer

Lennox Refac S.A.

ESQUEMA ELECTRICO
ELECTRIC DIAGRAM

ANA 15D-17D-20D-30D

3Z-33-888-204 070
3N 400V 50HZ + PE
3 ~ 230V 50HZ + PE