

LENNOX[®]

**INSTALLATION
OPERATING &
MAINTENANCE MANUAL**



PROVIDING **GLOBAL SYSTEM SOLUTIONS**

**Comfair
HD**

ENGLISH
MARCH 04

WALL FANCOIL UNITS

INDEX

Safety measures	1
Wall fancoil units installation	2
Name and functions of the parts	4
Preparation	7
Automatic operation	8
Mode of operation (COOLING, DEHUMIDIFYING, FAN, HEATING)	9
Adjusting the airflow	10
TIMER operation	11
SLEEP function	12
Air cleaning function	13
Cure and maintenance	13
Troubleshooting	14

SAFETY MEASURES

All the information in this manual must be read carefully and understood.

Pay particular attention to the operation standards with "DANGEROUS" or "WARNING!" signals as their disrespect can cause damage to the machine and/or persons or object..

If any malfunctions are not included in this manual, contact the Aftersales Service immediately.

Eden S.r.l. declines all responsibility for any damage whatsoever caused by improper use of the machine, and a partial or superficial acquaintance with the information contained in this manual.

Safety symbols



- Don't install this fancoil yourself: call the dealer authorized to carry out installation
- Avoid prolonged direct contact with the cooler airflow.
- Don't insert your fingers or objects into the outlet vent or the front cover grille.
- Don't start or stop the fancoil by means of the mains ON/OFF switch.
- Don't place objects on the fancoil.
- Don't allow water to come into direct contact with the fancoil.
- Don't direct the airflow into a fireplace or heating appliance.
- Don't touch the fins of the heat exchanger.
- Don't lock or cover the front panel or the outlet vent



- Contact authorised aftersales service personnel for any repair work.
- When moving house, call the authorised aftersales service for disconnecting and re-installing the unit.
- In the event of malfunctioning (burning smell, etc.), stop the appliance immediately and contact the authorised aftersales service.
- Disconnect the unit from the electric supply when it won't be used for a long time.
- Take precautions to prevent children from accidentally swallowing the batteries of the remote control.
- Always switch off the fancoil and remove the plug from the socket when cleaning the appliance or changing air filter.
- Remove the batteries from the remote control when it isn't going to be used for a long time.
- Always operate the unit with the air filter installed.
- Install the fancoil and the remote control at least one metre from any television or radio.
- Take all necessary precautions to prevent acces to children during installation.
- Make sure the the front panel has been firmly secured.

WALL FAN COIL UNITS INSTALLATION

AS follows we supply installation instruction for **HD** wall fancoil units.

Please consider that:

- Looking the unit frontally, the feeding pipes have direction right-left.
- the outside system pipes have to come from the left side.

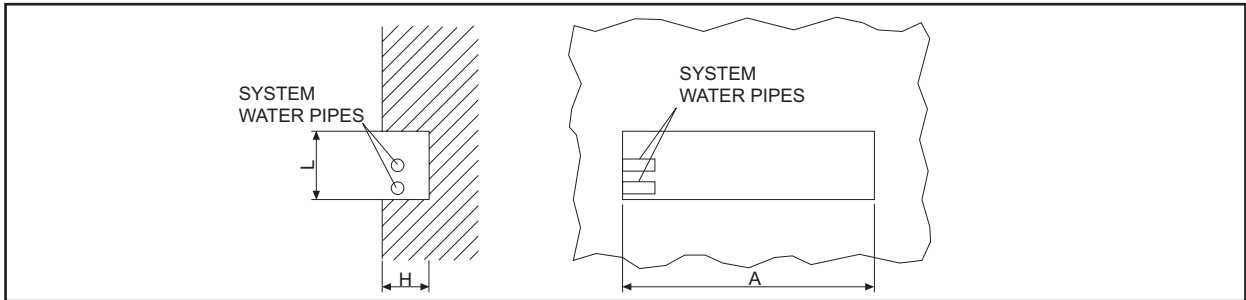

Provide a hole on the wall with the following dimensions. From the hole the system water pipes are coming out.:

A= 500

B= 80

H= 60

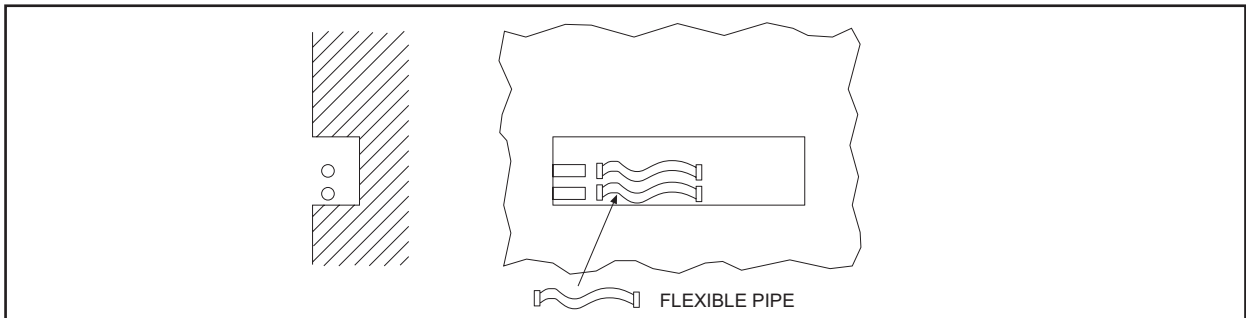

Provide 2 flexible pipes, connection 1/2" and make the connection to the system pipes.

Please isolate system pipes.

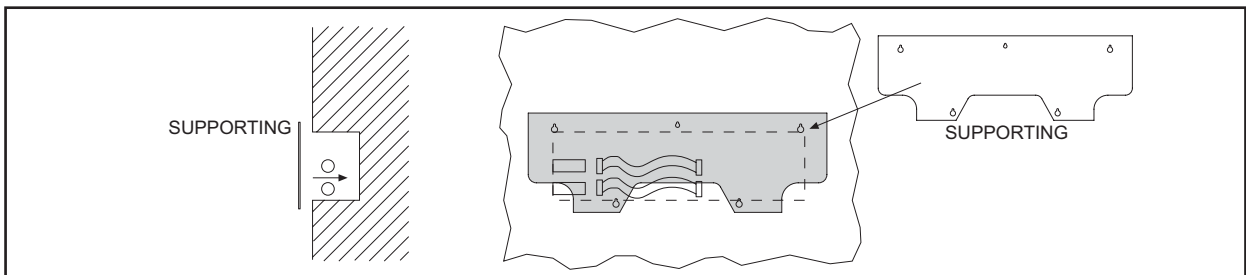

Provide fancoil supporting template fixing to the wall.

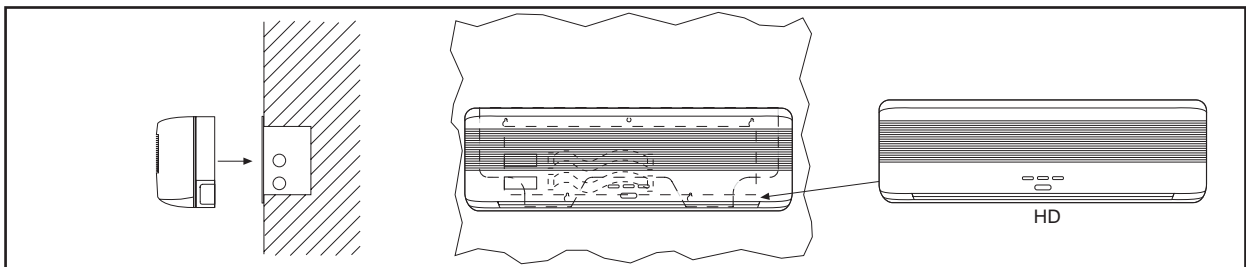

Fix the fancoil on the template

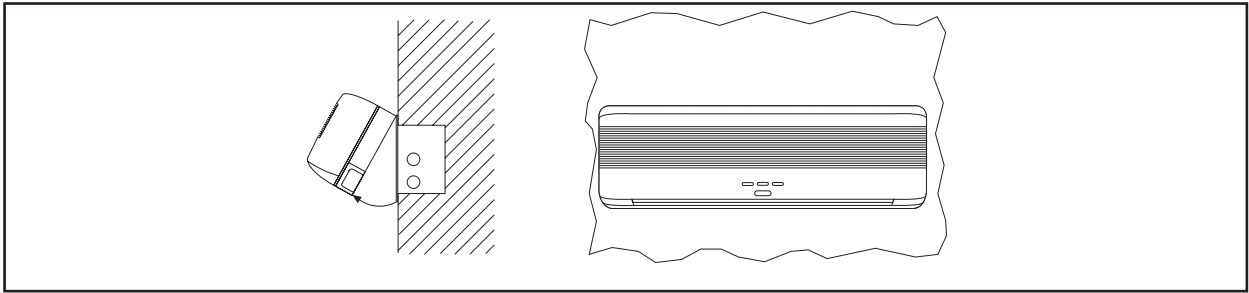

Elevate the fancoil from the lower part and provide hydraulic connections.

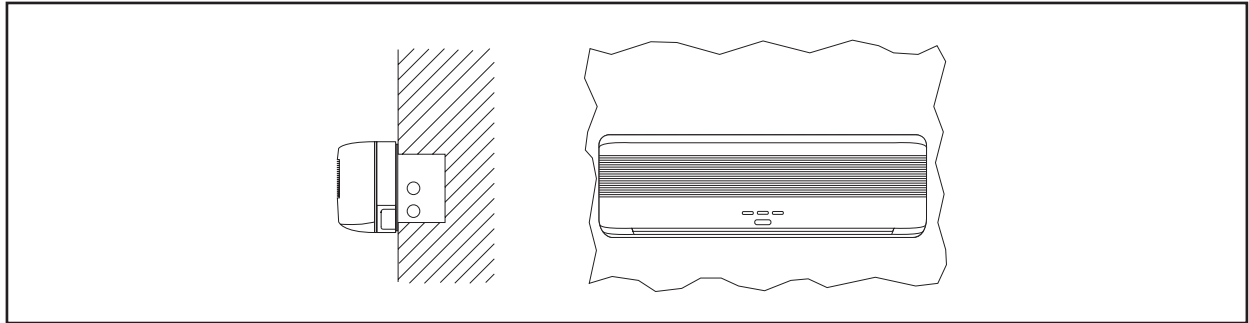

Locate the unit in the right operating position.

Hydraulic connections and condensate drain pipe dimension

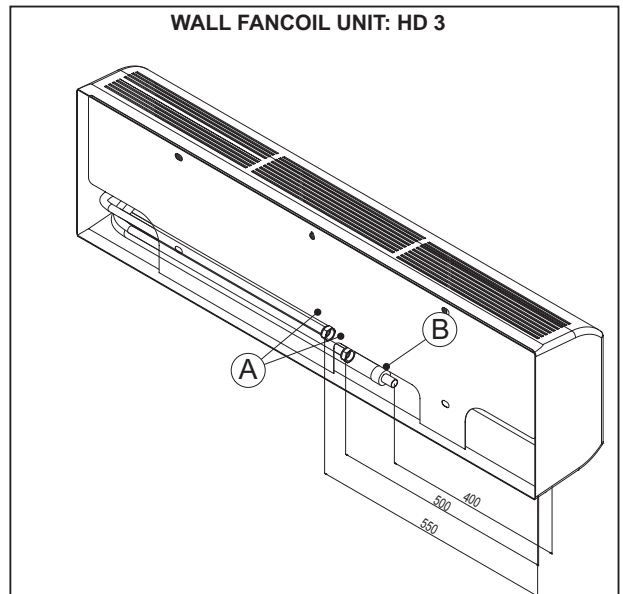
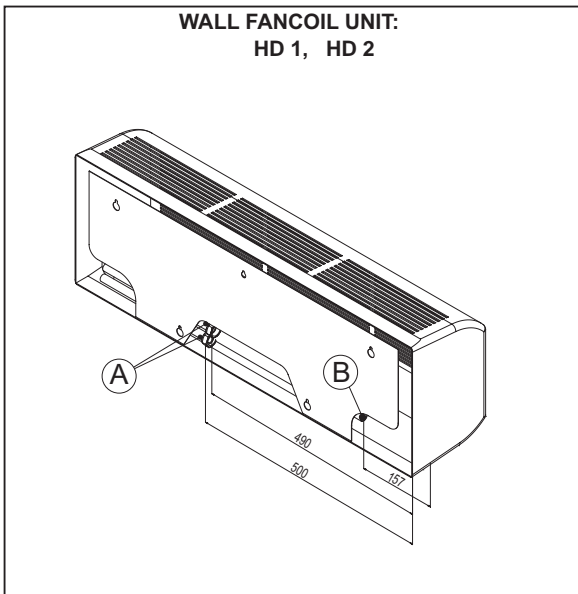

Caption

A Ø 1/2" water connection flexible pipes.

B Ø 16,5 mm condensate drain pipe.

NAMES AND FUNCTIONS OF THE PARTS

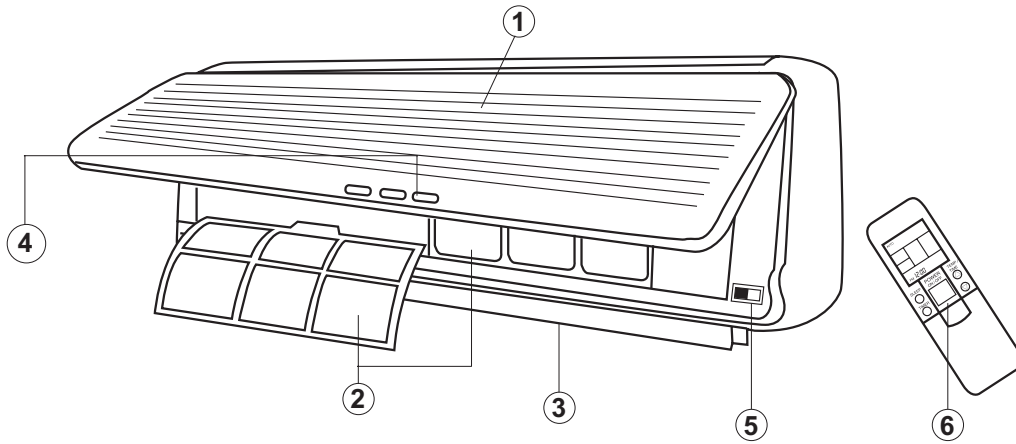

LEGEND:

- 1 Front cover
- 2 Air filter
- 3 Airflow direction flaps
- 4 Control panel
- 5 Power switch
- 6 Remot control

SIGNALINGS AND AUXILIARY KEYS OF CONTROL

1 NIGHT AND CLEAN AIR FUNCTION INDICATOR LIGHT (RED)

- This light comes on when the appliance is in the night function or the generator of negative ions mode.

2 OPERATION INDICATOR LIGHT (GREEN)

- This comes on when the unit is operating
 - It blinks for approx. twenty seconds when the power supply is switched on again.

3 TIMER INDICATOR LIGHT (YELLOW)

- This comes on when the timer is operating
 - It blinks when the protection system is operating.

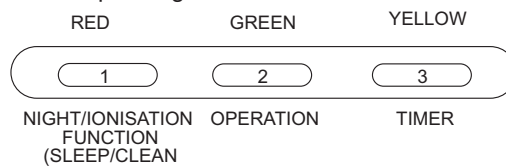

FUNCTIONS CONTROL PANEL

1 EMERGENCY BUTTON

- The emergency button may be used to activate the fancoil when the remote control si broken or lost. Operation in this case is in the fully automatic mode as follows:
 - Temperature control;
 - Fan control;
 - Airflow direction control

2 POWER SWITCH

ON: Put this position to start the units.
 OFF: Put to this position when the unit won't be used for a long time.

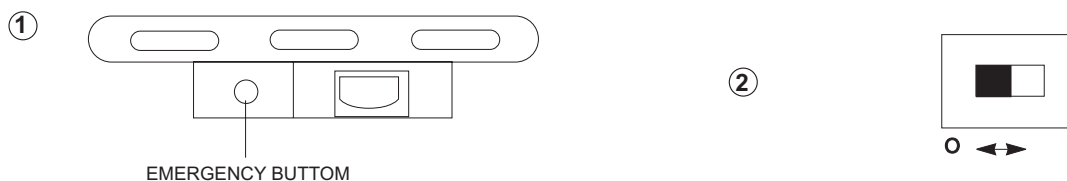

NAMES AND FUNCTIONS OF THE PARTS

REMOTE CONTROL

The remote control enables the user to set all unit operating parameters; these parameters are shown on a display to facilitate programming. The remote control runs on two 1,5 V batteries, monopole type R 03 AAA and optimal operation is guaranteed up to 7 meters from the unit

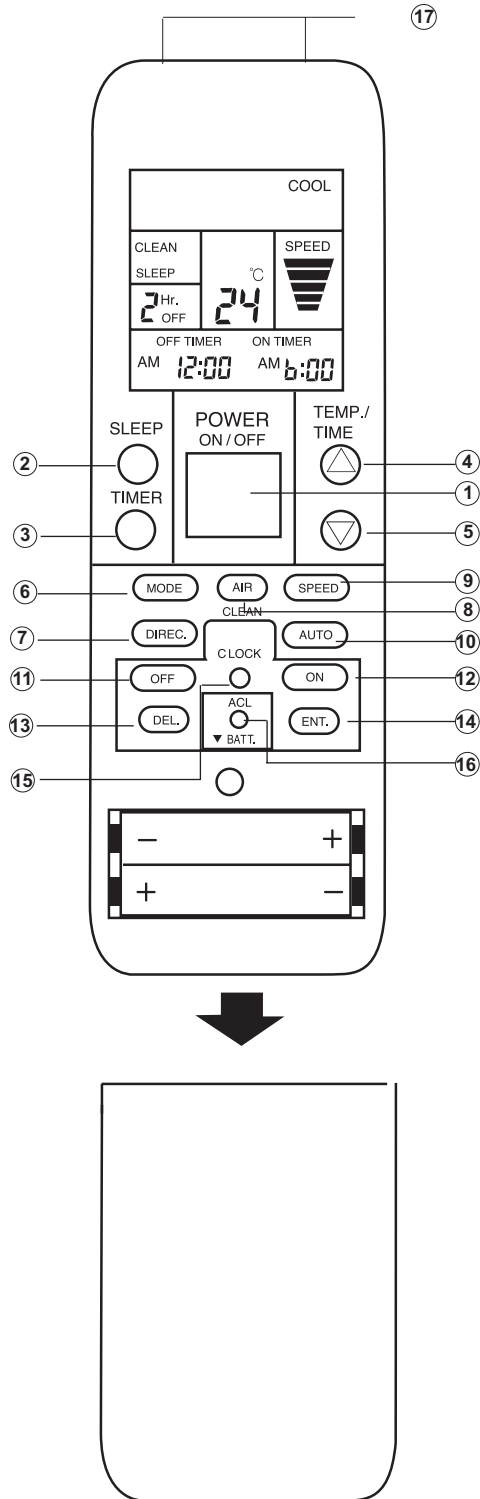

- 1 POWER ON/OFF**
- 2 SLEEP**
Press this button for the night mode operation. The temperature setting is changed automatically in conformity with the set time.
- 3 TIMER**
Press this button for adjusting the timer (1 ÷ 9 ore). Use this button for quick setting of the operating time.
- 4 TEMP/TIME**
Press this button to set the temperature and time (increase)
- 5 TEMP/TIME**
Press this button to set the temperature and time (decrease)
- 6 MODE**
Press this button to set the various modes of operation (automatic, cooling/heating, dehumidifying and fan).
- 7 DIREC.**
Use this button to adjust the airflow in a vertical direction (automatic, direction 1, direction 2, direction 3, direction 4, direction 5).
- 8 AIR CLEAN**
Press this button to generate negative ions and to clean the air in the room.
- 9 SPEED**
Press this button to select the fan speed (automatic, low, medium, high).
- 10 AUTO**
Press this button to set the airflow direction in the automatic mode.
- 11 OFF (timer)**
Set the time for when fancoil operation should stop.
- 12 ON (timer)**
Set the time for when fancoil operation should start.
- 13 DEL (timer)**
Use this button to delete the timer setting.
- 14 ENT (timer)**
Use this button to enter the timer setting.
- 15 CLOCK**
Use this button to set the current time.
- 16 ACL**
Use this button to erase all the settings made by the user in order to return to original setting.
- 17 SIGNAL TRANSMITTER**
The control signals are sent to the fancoil from this transmitter.

NAMES AND FUNCTIONS OF THE PARTS

REMOTE CONTROL DISPLAY

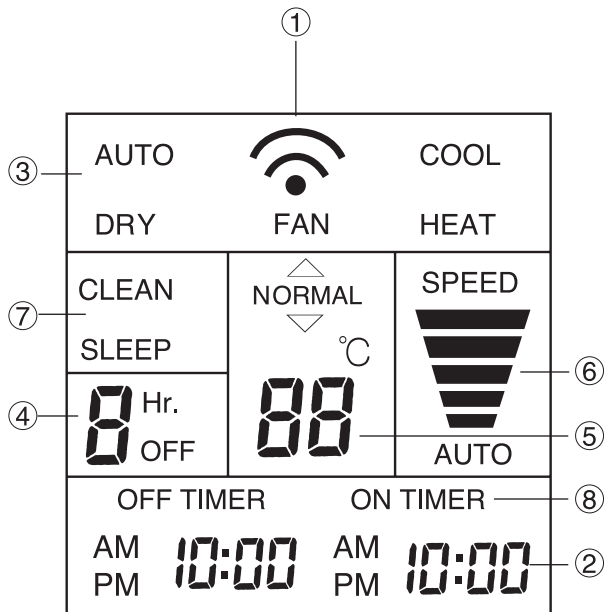

- 1 TRANSMISSION INDICATOR LIGHT**
This indicator light shows when a command has been sent to the appliance.
- 2 TIME DISPLAY**
This indicates both the current and the set time (AM, PM, from 1:00 a 12:59).
- 3 OPERATING MODE DISPLAY**
This shows the mode of operation (cooling, dehumidifying, etc.).
- 4 TIME SETTING DISPLAY**
This shows the time which the appliance should start operating.
- 5 TEMPERATURE SETTING DISPLAY**
This shows the thermostat setting.
- 6 FAN SPEED DISPLAY**
This shows the current fan speed.
- 7 NIGHT AND AIR CLEANING FUNCTION DISPLAY**
This shows that the night and negative ion generation functions have been set.
- 8 TIMER MODE DISPLAY**
This shows the current time, timer off, timer on.

The illustration shows the control display with all the indicator lights lit; only the currently request indicator lights, however, displayed upon actual use.

⚠ ATTENTION!

- The signals will not be transmitted correctly if a wall, curtain or other objects are situated between the FAN COIL and the remote control.
- The fancoil could operate incorrectly if strong light falls directly on the signal receiver. Use a curtain to protect from direct sunlight and place any lamp with a strong light far from the signal receiver.
- If there is another electronic appliance operating by remote control, move it or contact the authorised after-sales service.
- Do not put the remote control in a place where it could be exposed to direct sunlight or near heating appliances.
- Protect the remote control against heavy impact and do not allow water or other liquids to be sprayed onto it.
- When the remote control is used in rooms where there are quick start lamps, the FAN COIL may not receive the signals correctly.

PREPARATION

POWER SUPPLY

- 1 Make sure that the unit is connected to the electricity supply.**
- 2 Open the front cover**
- 3 Put the power switch to on**
- 4 Close the front cover**

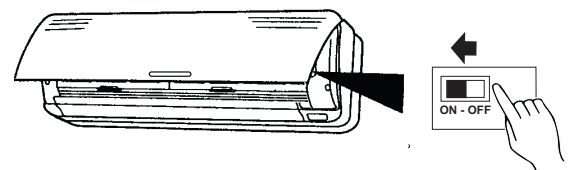

OPENING AND CLOSING THE FRONT COVER

- 1** Use both hands to pull the button edge of the front cover forwards by 30°
- 2** Use both hands to push the front cover upwards, raising it.

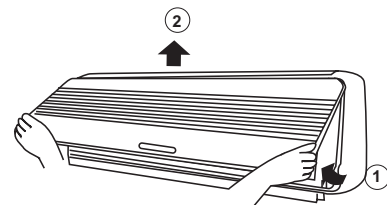

⚠ Don't operate the unit with the front cover open, since malfunctioning could occur.

Fit the hooks located at the top of the base unit into the holes in the top of the front cover grille and then press the bottom of the cover on both sides to lock it into place.

PREPARATION

PREPARING THE REMOTE CONTROL

INSERTING THE BATTERIES

- 1 **Press and slide the battery cover downwards.**
Gently press on the marked place and slide the cover in the direction of the arrow.
- 2 **Insert the batteries.**
Ensure that the battery poles are correctly positioned.
- 3 **Close the battery cover**

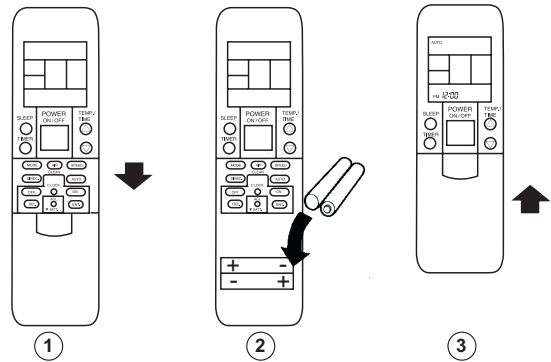

⚠ CAUTION!

- Take precautions to prevent children from accidentally.
- When the remote control won't be used for a long time, remove the batteries.
- The batteries should last approx. one year if used correctly. When the remote control range becomes notably reduced, replace the batteries and press the ACL button with the tip of a biro or another small pointed object.

SETTING THE CURRENT TIME

- 1 **Press the CLOCK button.**
- 2 **Use the ▲/▼ buttons to set the clock to the current time.**
Button ▲ : press this button to put the time forward.
Button ▼ : press this button to put the time back.
Each time the button are pressed, the time is put forward or back in steps of one minute; keep the buttons pressed to change time quickly with an increase/decrease of one minute every 0,1 second).
- 3 **Press the CLOCK button too.**
This confirm the time.
The symbol AM or PM stops flashing on display.

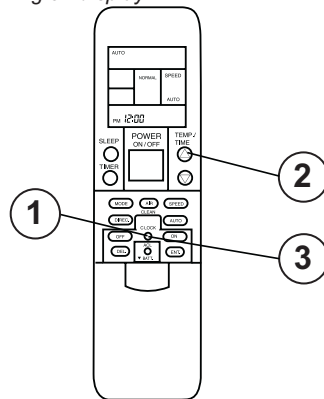

E.g.: when the clock is set to 11:30

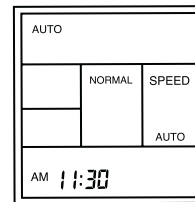

USING THE REMOTE CONTROL

The remote control should be pointed at the signal receiver in order to function directly:

- When a signal is correctly received by the fancoil, high-pitched beep is heard.
- If there's no beep, press the remote control again.

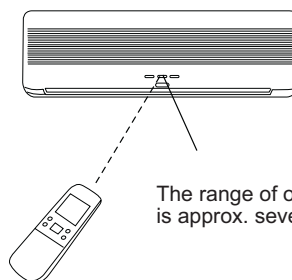

The range of operation is approx. seven metres.

AUTOMATIC OPERATION

SELECTING AUTOMATIC OPERATION

1 Press the POWER ON/OFF button (on/off control)

The fancoil starts operating upon pressing this button.

2 Press the MODE button and select AUTO (automatic).

The word AUTO appears on its own on the display. The transmission indicator light starts blinking, indicating that the commands have been sent and the signals will be transmitted after the button has been released. While AUTO is being set, the control unit may choose the mode of operation according to the room temperature. The modes of operation have been set as described below.

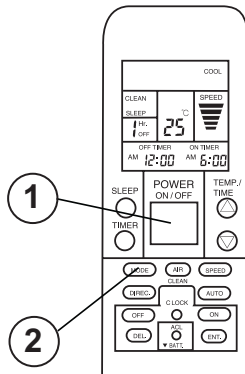

Cooling above 25°C
Dehumidifying 20°C-25°C
Heat pump below 20°C

25°C — Cooling
Dehumidifying
(only with solenoid valve installed)
20°C — Heat pump (heating)

Notes of automatic operation

The selected mode of operation will be automatically started, depending on the room temperature at the time of activation. Furthermore, depending on the mode of operation, the room temperature setting should take into account the set-point temperature (as indicated above).

Once the mode of operation has been selected, it will no longer be changed even if the room temperature changes. In the dehumidifying mode operation, the fan turns slowly to maximise dehumidification and the fan stops periodically.

CHANGING THE FAN SPEED

Press the SPEED button.

Each time the button is pressed the fan speed changes in the following order:

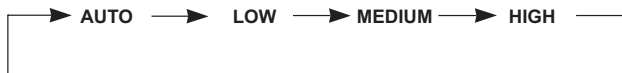

N.B.: After approx. 0,5 seconds the entire display reappears

When the speed is set in AUTO:

The fan speed changes according to the difference between the room and the set temperature. When this difference in temperature has been decreased, the fan speed decreased too.

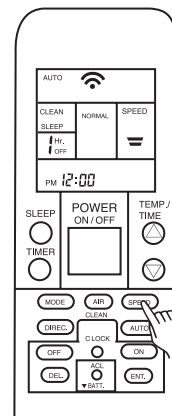

Display 0,5 second

Flash on time second

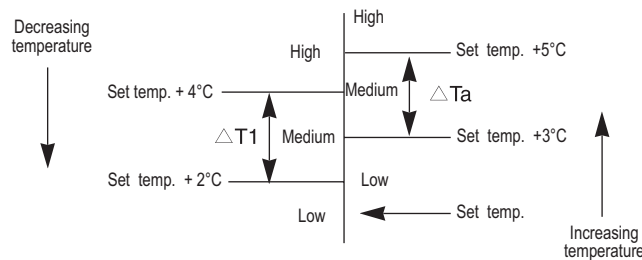

Difference in temperature: $\Delta T = \Delta T_a = 2,0^\circ\text{C} \pm 0,5^\circ\text{C}$

STOPPING OPERATION

Press the POWER ON/OFF button.

MODES OF OPERATION (COOLING, DEHUMIDIFYING, HEATING, FAN)

- 1 Press the **POWER ON/OFF** button
The fancoil starts to operate.

- 2 Press the **MODE** button and select the required mode.
Each time the button is pressed, the mode changes in the following order:

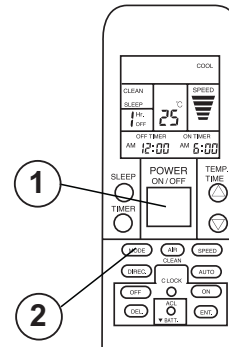
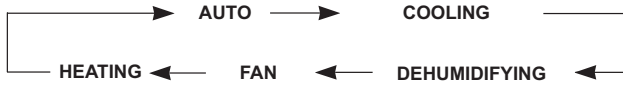

Modes of operation

Cooling mode

- Use this mode to cool the room.

Heating mode

- Use this mode to heat the room.
- Set the temperature on the thermostat; this should be higher than the current in the room. The heating functions does not activate if a lower temperature than that in the room is set on the thermostat.

Dehumidifying mode (only if the solenoid valve is installed).

- Use this mode for gentle cooling while dehumidifying the room..
- The room does not heat up during this function.
- The fan speed cannot be changed manually when the dehumidifying mode has been selected.

COOLING MODE

- 1 When the fan speed is set on **AUTO**, cooling operation is as follows

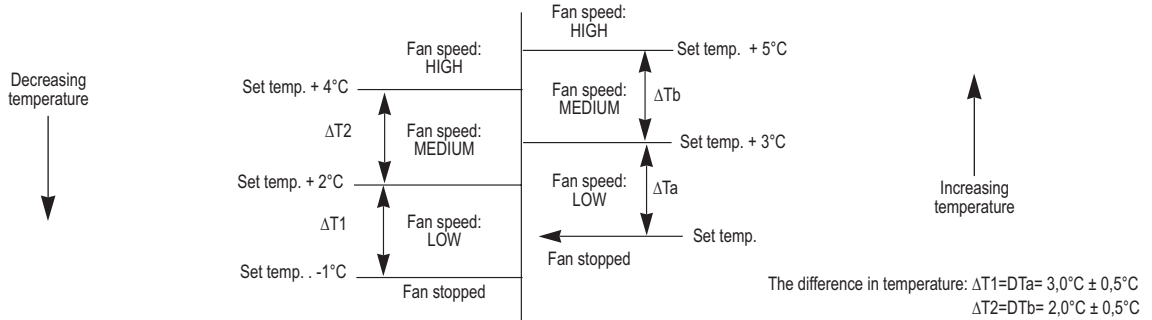

- 2 When the fan speed isn't set on **AUTO**, the cooling mode of operation is as follows:

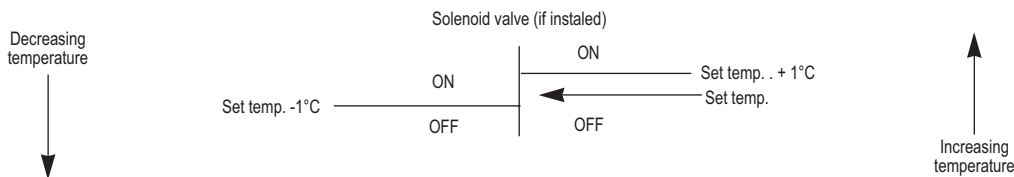

HEATING MODE

- 1 When the automatic fan speed function is set, the heating mode is as follows:

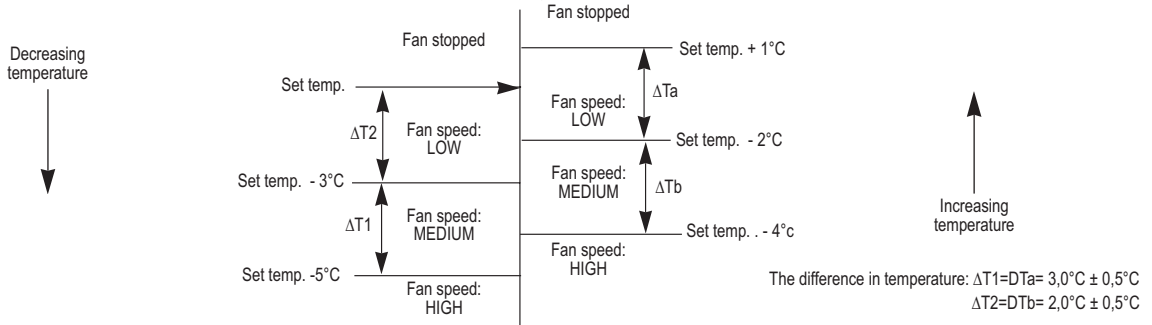

MODES OF OPERATION (COOLING, DEHUMIDIFYING, HEATING, FAN)

2 When the automatic fan speed isn't set, the heating mode is as follows:

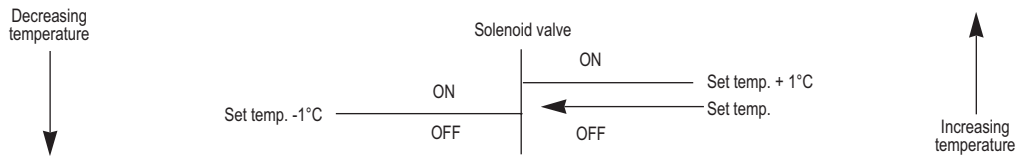

FAN MODE

When fan speed operation is activated, various levels are available for selection: high, medium, low, automatic

DEHUMIDIFYING MODE

When the fancoil is set to this operation mode, the control system checks operation of all components automatically to reduce air humidity. On start-up the fancoil operates in cooling mode until the set temperature is reached after which the ON/OFF cycles are activated.

1 PRESS THE ON/OFF button.

Fancoil is switched on and green lamp illuminates.

2 PRESS THE MODE button

Press the MODE button several times until the word DRY is displayed.

3 ADJUST THE TEMPERATURE AS REQUIRED (16°C - 30°C)

- to increase the value;
- to decrease the value;



ADJUSTING THE AIRFLOW DIRECTION

Use the DIREC button (airflow direction) on the remote control to adjust the direction of airflow up or down (the right-left direction is changed by moving the flaps by hand).

WARNING

- Don't introduce fingers or other objects into the flaps, since there is high-speed fan inside the unit, which could cause injury to persons or damage to property.
- Don't start the fancoil with the flaps locked as this could lead to malfunction.
- Don't try to set the motorised flaps by hand.

AUTOMATIC AIRFLOW DIRECTION ADJUSTMENT

PRESS AUTO button

The deflector oscillates automatically, between the minimum and maximum, opening to avoid stratification effects in heating and cooling operation modes. To interrupt automatic positioning press DIREC.

PRESS DIREC BUTTON

Press DIREC repeatedly; the deflector moves each time the button is pressed though the five set positions. If the DIREC button is pressed and held, the settings change continuously until the button is released. After pressing DIREC there may be short pause before the deflectors are moved to the new direction.

NOTES

- Always use the DIREC (airflow direction) button on the remote control to change the up and down position of the flaps. Do not try to set the flaps by hand, since this could cause malfunction. In the event of malfunction, switch off the FAN COIL momentarily and then switch on again to allow the flaps to return to the correct position.
- In the cooling and dehumidifying modes, condensate could form around the unit and drip from the air outlets if the flaps have been set in an unsuitable position for such modes. It is recommended that this position only be used for a short time.
- When the fan coil functions are not activated, the up and down flaps automatically close the air outlets.

ADJUSTING THE AIRFLOW DIRECTION

ADJUSTING THE DEGREE OF FLAP SWING

- 1 When the appliance is switched on or off, the flaps should swing fully upwards and then return to cover the entire air outlet.

- 2 **When the "Auto" button is pressed:**
 - a. The flaps swing downwards and then open fully. This action restores the set angle of opening.
 - b. The flaps swing 35° upwards in the cooling mode and 10° in the heating mode.
 - c. The flaps swing 45° downwards in the cooling mode. In the heating mode the flaps go back 10° in relation to the angle initially established after the first 5 swings.

- 3 **When the DIREC button is pressed, the flaps swing by 10°.**
 - a. The flaps swing downwards and then open fully. This action restores the set angle.
 - b. The flaps swing 35° upwards in the cooling mode and 10° in the heating mode.
 - c. The flaps swing 10° each time the DIREC button is pressed (from 35° until 75° when in the cooling mode, from 10° until 50° in the heating mode).
 - d. If this button is kept pressed, the flaps move continuously; the direction of airflow may be set by releasing the button when the flap is in the desired position.

ADJUSTING THE RIGHT-LEFT DIRECTION

Adjust the direction of the right-left flaps by hand as required.

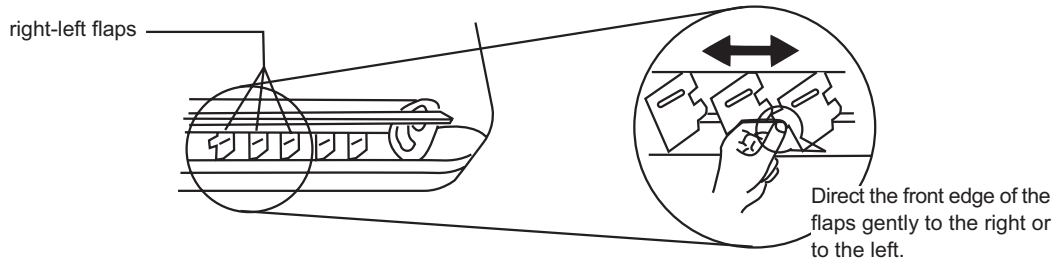

TIMER (CLOCK) FUNCTIONS

Before using the timer function, ensure that the remote control has been set to the current time.

ON TIMER

- 1 **PRESS THE ON BUTTON**
The message ON TIMER flashes on display and the start-up time below.
- 2 **SET THE START-UP TIME AS REQUIRED**
- 3 **PRESS ENT TO CONFIRM**
Once the start-up time is set, press ENT to confirm the setting. The message ON TIMER stops flashing. The fancoil will now start-up automatically at the set time.
- 4 **PRESS DEL TO CANCEL**
Press the DEL button to delete the selection.
Notes: to verify whether the timer is on that yellow lamp is lit.

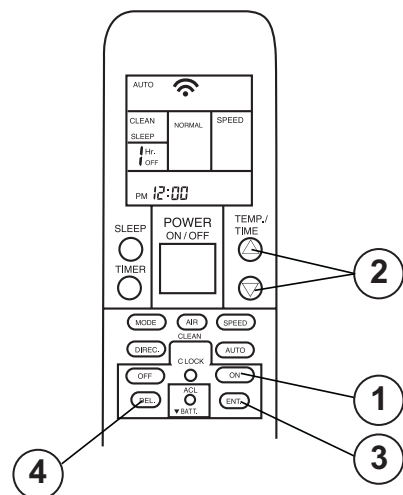

TIMER START UP

Before enabling this function ensure that the set time is correct.



TIMER SHUTDOWN

1 PRESS THE OFF KEY

The message OFF TIMER flashes on display and the start-up time below.

2 SET THE SHUTDOWN TIME AS REQUIRED

To change setting use the following button:

-  to decrease the value;
-  to increase the value.

Each time one of the above button pressed the time increases or decreases by 10 minutes. The display shows the set value.

3 PRESS ENT TO CONFIRM

Once the shutdown time is set, press ENT to confirm the setting. The message OFF TIMER stops flashing. The fancoil will now start up automatically at the set time.

4 PRESS DEL TO CANCEL

Press DEL button to delete the selection .

Notes: to verify whether the timer is on that yellow lamp is lit.

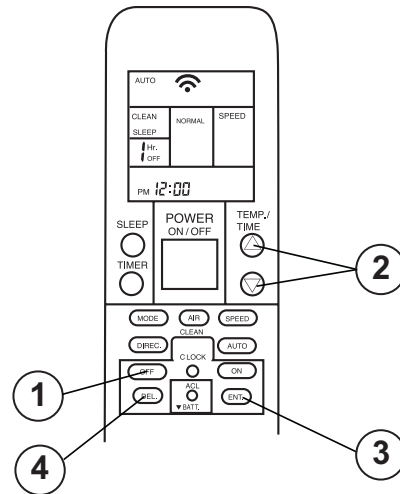

TIMER

For rapid operation time settings as required use the TIMER button. Press TIMER once to enable the function and the fancoil will run for one hour; for longer settings (up to 9 hours) press TIMER as many times as required to enter the set time.

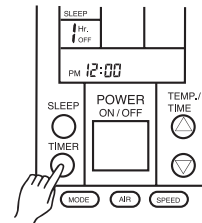

SLEEP FUNCTION

USING THE SLEEP FUNCTION

When the FAN COIL is operating or in standby, press the SLEEP button; a red light on the indoor unit comes on.

COOLING OR DEHUMIDIFYING MODE

When the fancoil is set to cooling or dehumidifying mode operation is as follow:

- one hour after start-up the set temperature is increased by 1°C
- two hours after start-up the set temperature is increased by 1°C. Then it's maintained until manual shutdown or until the set shutdown time.

HEATING MODE

- one hour after start-up the set temperature is decreased by 1°C
- two hours after start-up the set temperature is decreased by 1°C. Then it's maintained until manual shutdown or \ until the set shutdown time.

Notes: The temperature increase per hour (first two hours) by 1°C (cooling mode) and temperature decrease per hour (first two hours) by 1°C (heating mode) cannot be modified.

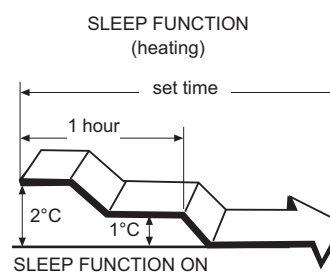
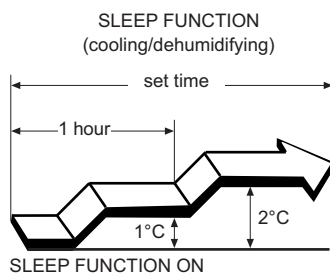

CLEANING THE AIR

AIR PURIFICATION: AIR CLEAN button

Press the AIR CLEAN button; the message CLEAN is displayed and the negative ion generator is activated and red lamp illuminates.

CURE AND MAINTENANCE

⚠️ WARNING!

- Before cleaning the unit make sure that it is switched off and disconnected from the power supply.
- There is a high-speed fan inside the unit, which could cause injury to persons.
- Have the unit operate in the fan mode for approx. half a day, if possible when the weather is fine in order to ensure that the internal parts will be dry.
- When the unit will not be used for a long time, disconnect it from the electricity supply.
- Diesel, petrol, solvents, insecticides and other chemical agents could damage the unit.
- Do not spray hair lacquer or foam or any other inflammable products onto the unit.
- Clean the unit with a cloth soaked in cold or warm water, then wipe dry with another soft, clean, dry cloth.
- Depending on the conditions of use, the internal parts of the unit become dirty after 2 or 3 seasons of use and efficiency could be jeopardised. For this reason the indicated maintenance is recommended. Contact the authorised after-sales service.

Removing the cover

- 1 Use both hands to pull the bottom edges of the cover approx. 30° upwards.
- 2 Push the cover upwards using both hands and lift.
- 3 Lift the cover up until it can be removed (the grille cannot be removed unless it is raised sufficiently).

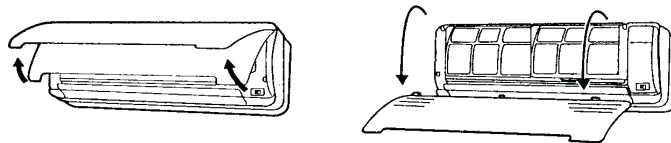

Cleaning the front cover

Use a vacuum cleaner to remove the accumulated dust, then clean the grille using a clean, damp cloth. Wipe over with a clean, dry cloth.

Mounting the front cover

- 1 Keep the cover horizontal and squeeze the two hooks on the base unit.
- 2 Insert the hooks at the top of the base unit into the holes in the grille and press on the two bottom sides of the cover in order to lock it into place.

CLEANING THE AIR FILTER

If dirt collects on the air filter the airflow could be reduced and consequently unit efficiency with a consequent possible increase in noise. Make sure that the filters are cleaned at the start of a season and during the period of frequent use. Clean them once a fortnight.

Removing the air filter

- 1 Remove the front cover.
- 2 Raise the filters slightly in order to free the two hooks located at the bottom, then pull them downwards and remove.

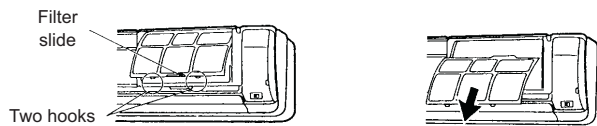

Cleaning the air filter

Either use a vacuum cleaner to remove the accumulated dust from the filters or wash them with a solution of neutral soap. In this case let them dry in the shade prior to use.

Installing the air filter

- 1 Align the filters with the drain duct on the panel and push them as far as they will go.
- 2 Insert the two filter hooks into the holes in the base unit and press them.
- 3 Close the cover.

RESEARCH OF THE BREAKDOWNS

WARNING!

In the event of malfunction (burning smell or such), stop operation immediately, disconnect from the power supply and contact the authorised after-sales service. Just switching off the unit does not fully cut off the power supply. Always make sure that the on/off switch is put to off to ensure that the unit is fully disconnected from the power supply.

Before requesting service, carry out the following checks:

IT IS NORMAL...

- During operation and immediately after the system is switched off there could be the noise of water running inside the unit pipes.
- During operation there could be creaking caused by the expansion of the front cover due to the change in temperature.
- The indoor unit could emit odours that come from the furniture, tobacco and other things present in the room.
- During cooling and dehumidifying operations, slight mist could be emitted by the unit. This is caused by the sudden cooling, which produces condensation and mist.
- The fan could turn slowly in the dehumidifying mode or when the unit is checking the room temperature.
- The fan turns very slowly in the automatic operation control.

IF THE UNIT DOESN'T WORK...

- Has the power supply been cut off?
- Has there been a drop in voltage?
- Has a fuse blown or the switch tripped?
- Is the on/off switch in the off position?
- Is the timer working?

IF THE UNIT DOES NOT COOL ENOUGH ...

- Is the air filter dirty?
- Are the air inlet grilles or outlets obstructed?
- Is the room temperature setting correct?
- Is a window or door open?
- In the case of cooling operation, is sunlight entering any room? (draw the curtains)
- In the case of cooling operation, are there any heating appliances, a computer or many people in the room?

ALLEMAGNE : **LENNOX DEUTSCHLAND GmbH**
tel. : + 49 69 42 09 79 0
fax : + 49 69 42 09 79 40
e-mail : info.de@lennoxdeutschland.com

**ANGLETERRE,
IRLANDE :** **LENNOX INDUSTRIES LTD**
tel. : + 44 1604 599400
fax : + 44 1604 594200
e-mail : marketing@lennoxind.com

BELGIQUE : **LENNOX BENELUX N.V./S.A.**
tel. : + 32 3 633 30 45
fax : + 32 3 633 00 89
e-mail : info.be@lennoxbenelux.com

ESPAGNE : **LENNOX REFAC S.A.**
tél. : + 34 902 400 405
fax : + 34 91 542 84 04
e-mail : marketing@lennox-refac.com

FRANCE : **LENNOX FRANCE**
tel. : + 33 4 72 23 20 20
fax : + 33 4 78 20 07 76
e-mail : accueil@lennoxfrance.com

PAYS-BAS : **LENNOX BENELUX B.V.**
tel. : + 31 33 2471 800
fax : + 31 33 2459 220
e-mail : info@lennoxbenelux.com

POLOGNE : **LENNOX POLSKA Sp. z o. o.**
tel. : + 48 22 832 26 61
fax : + 48 22 832 26 62
e-mail : lennoxpolska@inetia.pl

PORTUGAL : **LENNOX CLIMATIZAÇÃO LDA.**
tel. : +351 22 998 33 70
fax : +351 22 998 33 79
e-mail : marketing@lennoxportugal.com

REPUBLIQUE TCHEQUE : **JANKA RADOTIN AS**
tel. : + 420 2 510 88 111
fax : + 420 2 579 10 393
e-mail : janka@janka.cz

RUSSIE : **LENNOX DISTRIBUTION MOSCOW**
tel. : + 7 095 246 07 46
fax : + 7 502 933 29 55
e-mail : lennox.dist.moscow@mtu-net.ru

SLOVAQUIE : **LENNOX SLOVAKIA**
tel. : + 421 7 44 87 19 27
fax : + 421 7 44 88 64 72

UKRAINE : **LENNOX DISTRIBUTION KIEV**
tel. : + 380 44 461 87 75
fax : + 380 44 461 87 75
e-mail : lennoxua@i.kiev.ua

AUTRES PAYS EUROPEENS : **LENNOX DISTRIBUTION**
AFRIQUE, tel. : + 33 4 72 23 20 14
MOYEN-ORIENT : fax : + 33 4 72 23 20 28
e-mail : marketing@lennoxdist.com



LENNOX[®]