

# User manual

## CLIMATIC™ 40

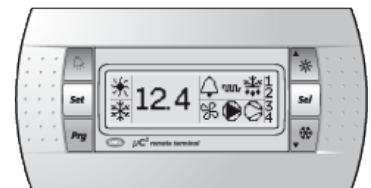

- Providing indoor climate comfort

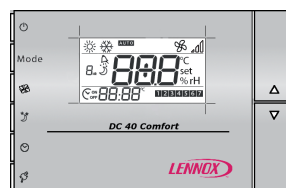

<b>CONTENTS</b>	<b>PAGE</b>
• INDEX	1
• CONTROL DESCRIPTION	
1.- CLIMATIC 40 CONTROL	2-4
2.- DC41 TERMINAL (ECOLEAN)	4
3.- DC40 REMOTE TERMINAL (AIRCOOLAIR)	5-7
• MENU	8-9
• REGULATION	
1.- ECOLEAN	10
2.- AIRCOOLAIR	10
3.- AIRCUBE	10
• ADVANCED FUNCTIONS	
1.- REMOTE ON/OFF	11
2.- REMOTE CHANGEOVER WINTER / SUMMER	11
3.- DYNAMIC SET POINT	11
4.- BMS COMUNICATIONS	12
5.- TIME BANDS PROGRAM (ECOLEAN)	12
6.- LOW NOISE	13
7.- ANALOGIC / DIGITAL INPUT	13-14
8.- TIMING AND DELAYS	14-15
9.- DEFROST	15
10.- CONDENSER FAN SPEED CONTROL	16
11.- FREE COOLING	17
• PARAMETERS	18-20
• SAFETY DEVICES	21
• ASSEMBLY AND INSTALLATION INSTRUCTIONS	22-23
• ALARMS	24-27

# CONTROL DESCRIPTION

## 1.- CLIMATIC 40 CONTROL

Climatic 40 control, is an electronic device that controls Ecolean units EAC/EAR (chiller units), Aircoolair units ANCM/ANHM (air-air units) and Aircube units KSCM/KSHM (condensing units).

The thermostat allows the following operations:

- Unit ON/OFF.
- Select system operating mode.
- Set point adjustment.
- Alarm signal relay.
- Display temperature, units status and pending alarms.
- Time bands programming.
- BMS communications.
- Possibility of remote ON/OFF.

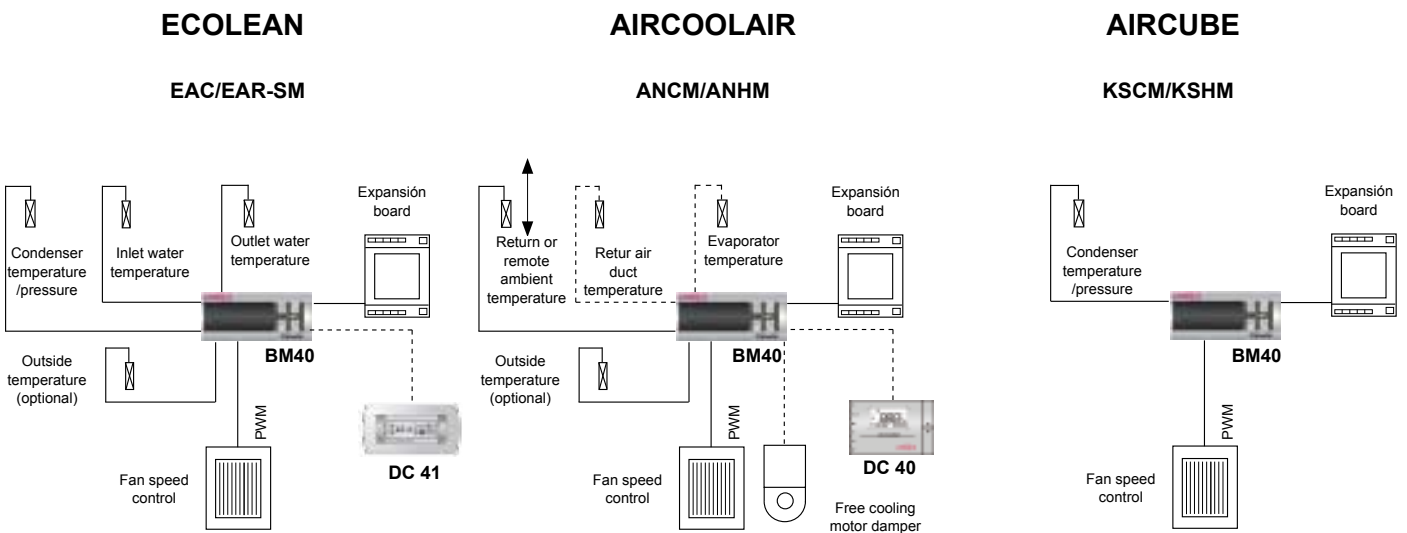

Inlet and outlet water, temperature/pressure condenser and outdoor (optional) temperature probes.

Proportional regulation based on inlet water temperature (cooling and heating mode).

Defrost cycle (heat pump units), with pressure transducer.

Condensing pressure control with temperature probe or pressure transducer.

Flow switch, antifreeze, high and low pressure protections.

Compressors, water pump, fans and electrical heater management.

Return / remote ambient, evaporator, temperature/pressure condenser and outdoor (optional) temperature probes.

Proportional regulation based on remote ambient /return temperature (cooling, heating and automatic mode).

Defrost cycle (heat pump units), with pressure transducer.

Condensing pressure control with temperature probe or pressure transducer.

Antifreeze, high and low pressure protections.

Compressors, indoor and outdoor fans, electrical heater and freecooling (optional) management.

Condenser temperature/pressure probes.

Regulation based on remote free voltage contacts.

Defrost cycle (heat pump units), with pressure transducer.

Condensing pressure control with temperature probe or pressure transducer.

High and low pressure protections.

Compressors, indoor (optional) and outdoor fans.

## CONTROL DESCRIPTION

### CLIMATIC 40 CONTROL

The figure and the table below, show the symbols present on the display and on the keypad and their meanings:

Main screen shows: inlet water temperature for ECOLEAN, ambient temperature for AIRCOOLAIR and unit status (On/Off) for AIRCUBE.

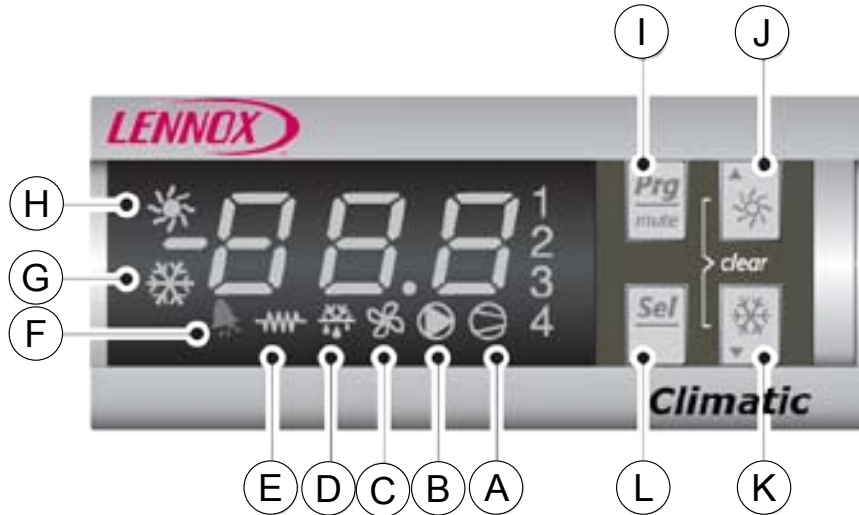

SYMBOL	DESCRIPTION	
	LED ON	LED FLASHING
1:02	Compressor 1 and /or 2 (circuit 1) ON.	Start up request.
3:04	Compressor 3 and /or 4 (circuit 2) ON.	Start up request.
A	At least 1 compressor ON.	
B	Water pump/Indoor fan ON.	Start up request.
C	Condenser fan ON.	
D	Defrost active.	Start up request.
E	Electrical heater ON.	
F	Alarm active.	
G	Cooling mode.	Cooling mode request.
H	Heat pump mode.	Heat pump mode. Request.

BUTTON	DESCRIPTION	TIME
I	Go up a sub-group inside the programming area, until exiting (saving changes to EEPROM).	Press once
L	Access the direct parameters.	Press for 5 s
	Select item inside the programming area and display value of direct parameters/confirm the changes to the parameters.	Press once
I+L	Program parameters afters entering password.	Press for 5 s
J	Select top item inside the programming area.	Press once
	Increase value.	Press once
	Switch from standby to heat pump mode and vice versa.	Press for 5 s
	Provides immediate access to the condenser and evaporator pressure and temperature probes.	Press once
K	Select bottom item inside the programming area.	Press once
	Decrease value.	Press once
	Switch from stand-by to chiller mode and vice versa.	Press for 5 s
	Provides immediate access to the condenser and evaporator pressure and temperature probes.	Press once
J+K	Manual alarm reset.	Press for 5 s
	Immediately reset the hour counter (inside the programming area).	Press for 5 s
L+J	Force manual defrost on both circuits.	Press for 5 s

## CONTROL DESCRIPTION

### 1.- CLIMATIC 40 CONTROL

#### 1.1.- ECOLEAN

##### 1.1.1.- TURN ON/OFF THE UNIT

In order to **turn on the unit**, press for **2 seconds** the “☀” button, for the heat pump mode, or the “❄” button, for the cooling mode.

The display shows unit's operating mode together with the symbols of the working elements (compressors, water pump etc.).

In order to turn off the unit, press for 2 seconds the “☀” button (if the unit is working in heat pump mode) or the “❄” button (if the unit is working in the cooling mode).

##### 1.1.2.- SELECTING THE UNIT'S OPERATING MODE

If the unit is in stand-by, the operating mode is selected in the start-up (as explained above).

In the case the unit is working in cooling or heating mode, in order to change the operating mode, you have to turn off the unit before, and only then you can turn it on in the operating mode you want.

##### 1.1.3.- SELECTING THE WATER TEMPERATURE OF THE SYSTEM

To modify unit working set point you have to change r1 parameter (cooling set point) or r3 parameter (heating set point).

To see how to change a parameter see chapter 3 *MENU (SETPOINT SETTINGS AND OPERATING HOURS DISPLAY MENU* paragraph).

### 1.2.- AIRCUBE

#### 1.2.1.- TURN ON/OFF THE UNIT

The unit turns on closing On/Off contact and turns off opening it (see section 1, advanced functions, for more details).

#### 1.2.2.- SELECTING THE UNIT'S OPERATING MODE

Heating mode is selected opening remote changeover contact while cooling mode is selected closing it (see section 2, advanced functions, for more details).

#### NOTE

Set point has no meaning in Aircube units because the compressors are directly controlled by remote contacts.

## 2.- DC41 REMOTE CONTROL (ECOLEAN)

**OPTION**

DC41 terminal is an optional keypad that allows to manage Climatic 40 controller from a remote position. The buttons and indications on the display faithfully reproduce the Climatic 40 user interface.

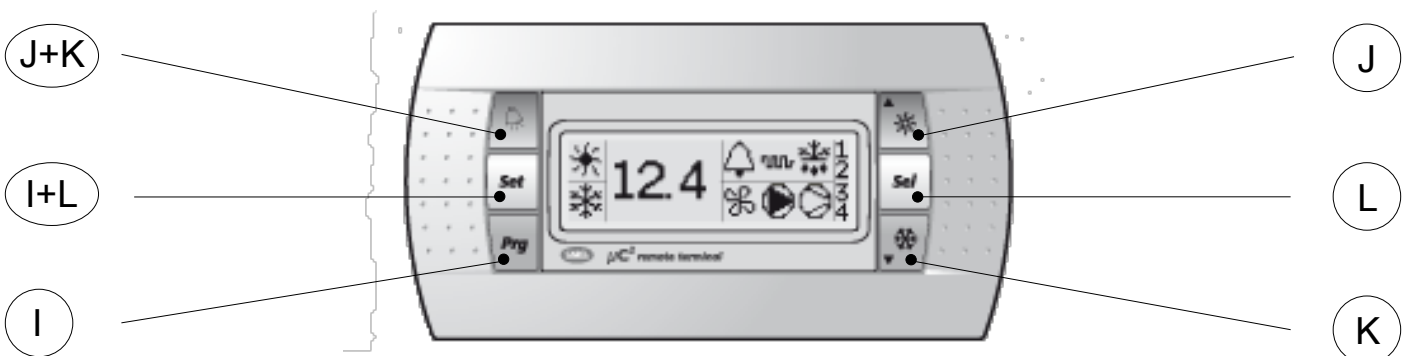

## CONTROL DESCRIPTION

### 3.- DC40 REMOTE TERMINAL (AIRCOOLAIR)

The figure and the table below, show the symbols present on the display and on the keypad and their meanings. In the main field of display, it appears OFF, if the machine is stopped or the set point, if the machine is working.

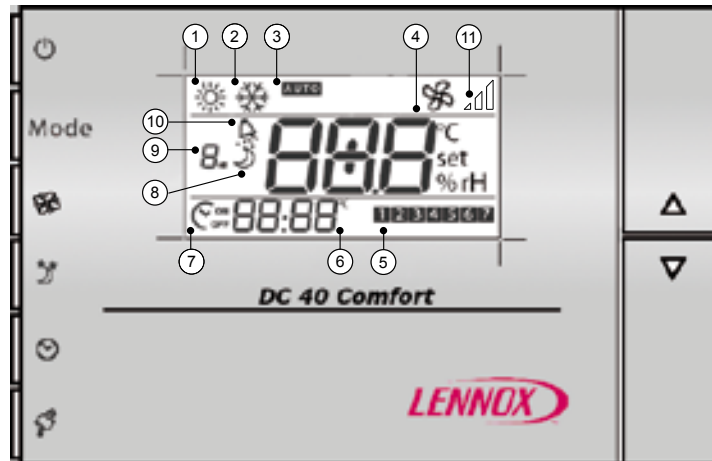

BUTTON	NAME	DESCRIPTION
	POWER	Switch from stand-by to ON and vice versa.
Mode	MODE	Change operating mode (cooling, heating, automatic).
	FAN	Switch the indoor fan from automatic mode to always ON and vice versa.
	SLEEP	Activate/deactivate the sleep mode.
	CLOCK	Activate/deactivate the time bands.
	TEMP.	Show the setpoint when the unit is OFF.
	UP/DOWN	Set the temperature set point.

Secondary functions:

BUTTON	BUTTON PRESS	FUNCTION
	3 seconds	Set sleep differential value of the current operating mode.
	3 seconds	Set the time bands (hour, day, set point).
	5 seconds	Clock setting.
	3 seconds	Reset alarms.

Display symbols:

SYMBOL	MEANING	SYMBOL	MEANING
1	Heating mode.	7	On/Off time bands.
2	Cooling mode.	8	Sleep mode.
3	Automatic mode.	9	Sleep mode duration.
4	Set point.	10	Alarm.
5	Day of the week (weekday, weekend).	11	Indoor fan mode.
6	Hour/Temperature.		

---

## CONTROL DESCRIPTION

### 3.1.- TURN ON/OFF THE UNIT WITH REMOTE CONTROL DC40 (AIRCOOLAIR)



To **turn on** the unit press the “” button.

The display shows current operating mode.

### 3.2.- SELECTING THE UNIT'S OPERATING MODE

Once the unit is turned on, you can select Cooling, Heating or Automatic mode just pressing “**Mode**” button. In the automatic mode you just choose the set point and the system automatically switches from cooling to heating mode, depending on the position of the ambient temperature in respect to the set-point.

### 3.3.- SELECTING DESIRED ROOM TEMPERATURE

If unit is working, the “ ” buttons allow to select the desired room temperature (set-point).

The button “” allows the increase of the current set-point by 0.5°C.

The button “” allows the decrease of the current set-point by 0.5°C.

### 3.4.- SELECTING THE FAN OPERATING MODE (Aircoolair)

To be able to select a fan operating mode, cool, heat or auto unit's operating mode must be selected.

Pressing “” side button scrolls through the following modes: FAN CONSTANTLY ON, or AUTO

FAN CONSTANTLY ON: Fan is continuous ON, the symbol “” will appear.



AUTO: Fan on and off together with the compressor, the symbol “” will appear.

### 3.5.- SLEEP FUNCTION

This function increases (in cooling mode) or decreases (in heating mode) the operating set point according to the lower level of comfort required during the night.

Not possible with time bands program.

#### ACTIVATION

Press once “” button. The display shows “” symbol with “1<sub>HR</sub>” flashing.

In this way, sleep function will be working for 1 hour.

If you want it works for more hours, press “” button more times while “1<sub>HR</sub>” is still flashing (each button pression increases by 1 hour, till max 9 hours).



At the end the display shows “” symbol with the number of hours you choose.

#### DEACTIVATION

Press once “” button and sleep function will be deactivate (if it was activated before). Symbol “” disappears from the display.

#### DIFFERENTIAL SETTINGS











Press “” button for 3 seconds. Sleep differential (the value you increase or decrease to comfort set-point) appears on the display.

Use “ ” buttons to set the value, then press “” button to accept.

Note that cooling and heating mode have different sleep differential values, so you can modify only current operating mode's one.

### 3.6.- CLOCK SETTINGS

To set actual time:

1. Press “” button for 6 seconds. “rtc” and actual time appears on the display (hours are flashing).
2. Set the hour by “ ” buttons.
3. Press “” button to accept. Minutes start flashing on the display.
4. Set the minutes by “ ” buttons.
5. Press “” button to accept. “day” and the number of the day of the week appear on the display (Monday=1, Tuesday=2 etc.)
6. Set the day by “ ” buttons.
7. Press “” button to accept.

### 3.7.- TIME BANDS PROGRAM

This function allows you to program time bands during the week, each one with a different set-point. In this way you can suit the cool/heat provided by the unit to each moment of the day.

You can set two time bands for the weekdays and other two for the weekend.

# CONTROL DESCRIPTION

## CONFIGURATION

a) Enter time bands menu.



b) Set 1<sup>ST</sup> time band of weekdays starting hour.

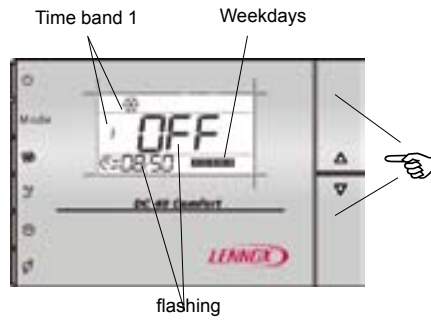

c) Accept.



d) Set 1<sup>ST</sup> time band of weekdays starting minutes.

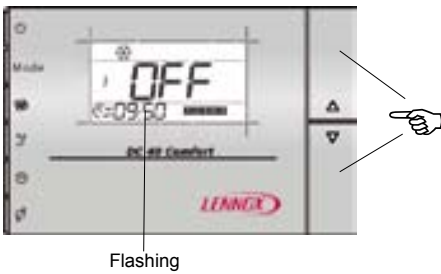

e) Accept.



f) Set 1<sup>ST</sup> time band of weekdays set-point (on/off/temperature).

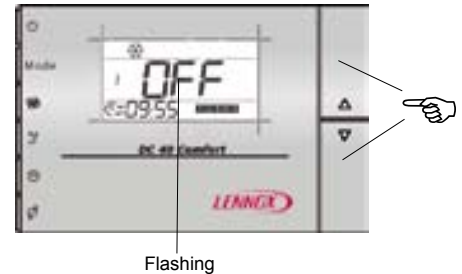

g) Accept.



h) Repeat b-c-d-e-f-g steps to program 2<sup>nd</sup> time band of weekdays.

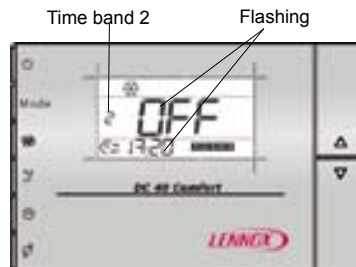

i) Repeat b-c-d-e-f-g-h steps to program the two time bands of weekend.

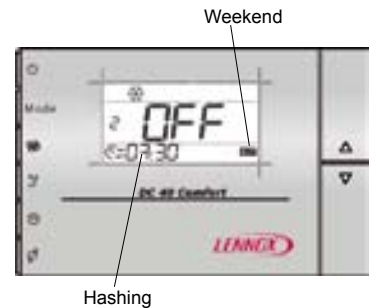

## ACTIVATION

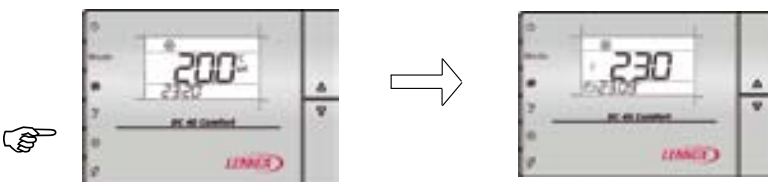

## DEACTIVATION

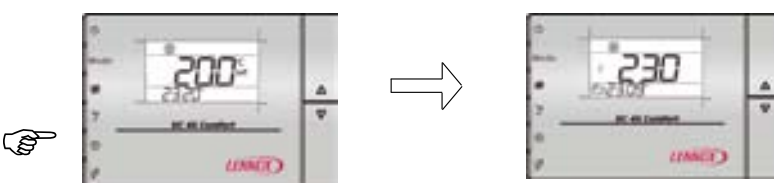

## EXAMPLE IN SUMMER

Hour	Weekdays	Weekend
8:00 (Time band 1)	22°C	OFF
18:00 (Time band 2)	23°C	OFF

NOTA: You must set the DC40 clock before programming time bands.



# MENU

Access to the menu:

## A) PROBES DISPLAY MENU



Press “” button, to enter probes display menu.  
“b01” or “b02”, appears on the display (it depends on the unit configuration).

## B) SETPOINT SETTINGS AND OPERATING HOURS DISPLAY MENU



5 sec.

Press “Sel” button, for 5 seconds.  
“”, appears on the display.

## C) PARAMETERS EDITING MENU



a) Press “Pgr” and “Sel”,  
at the same time, for 5  
seconds.



b) Set password “22” by  
“” and “” buttons.



c) Press “Sel”, to accept.

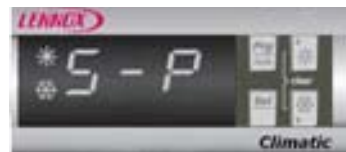

d) Press “Sel”, to enter  
parameters Editing menu.

To go to different values in the menu, follow the previous information.

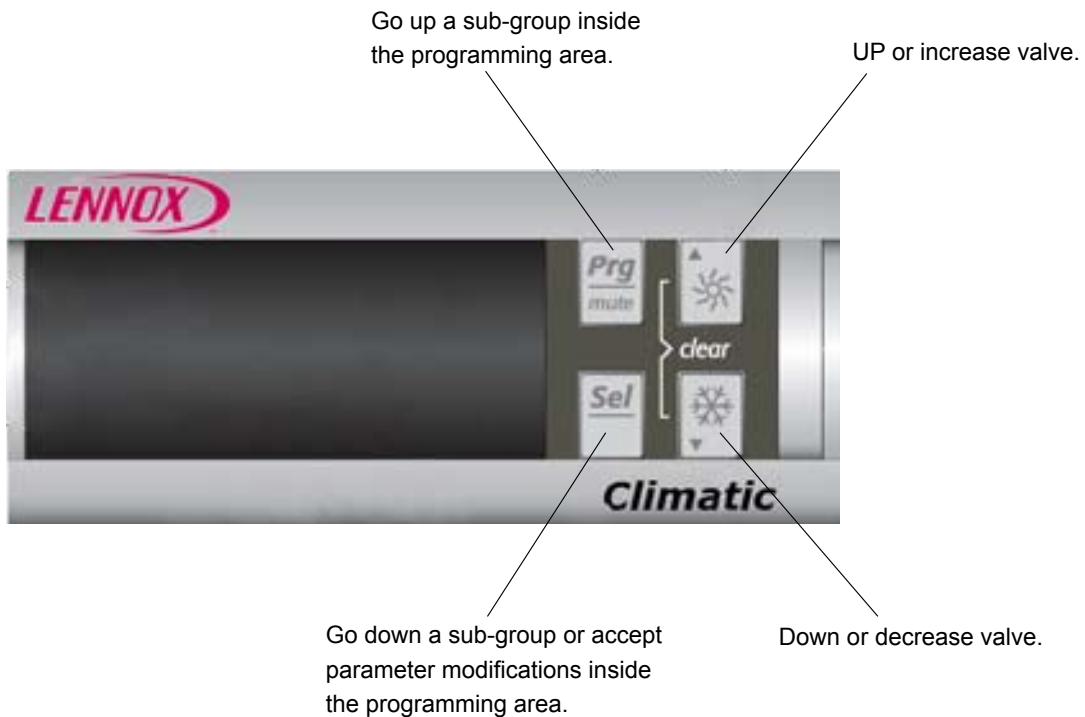

# MENU

## MENU TREE

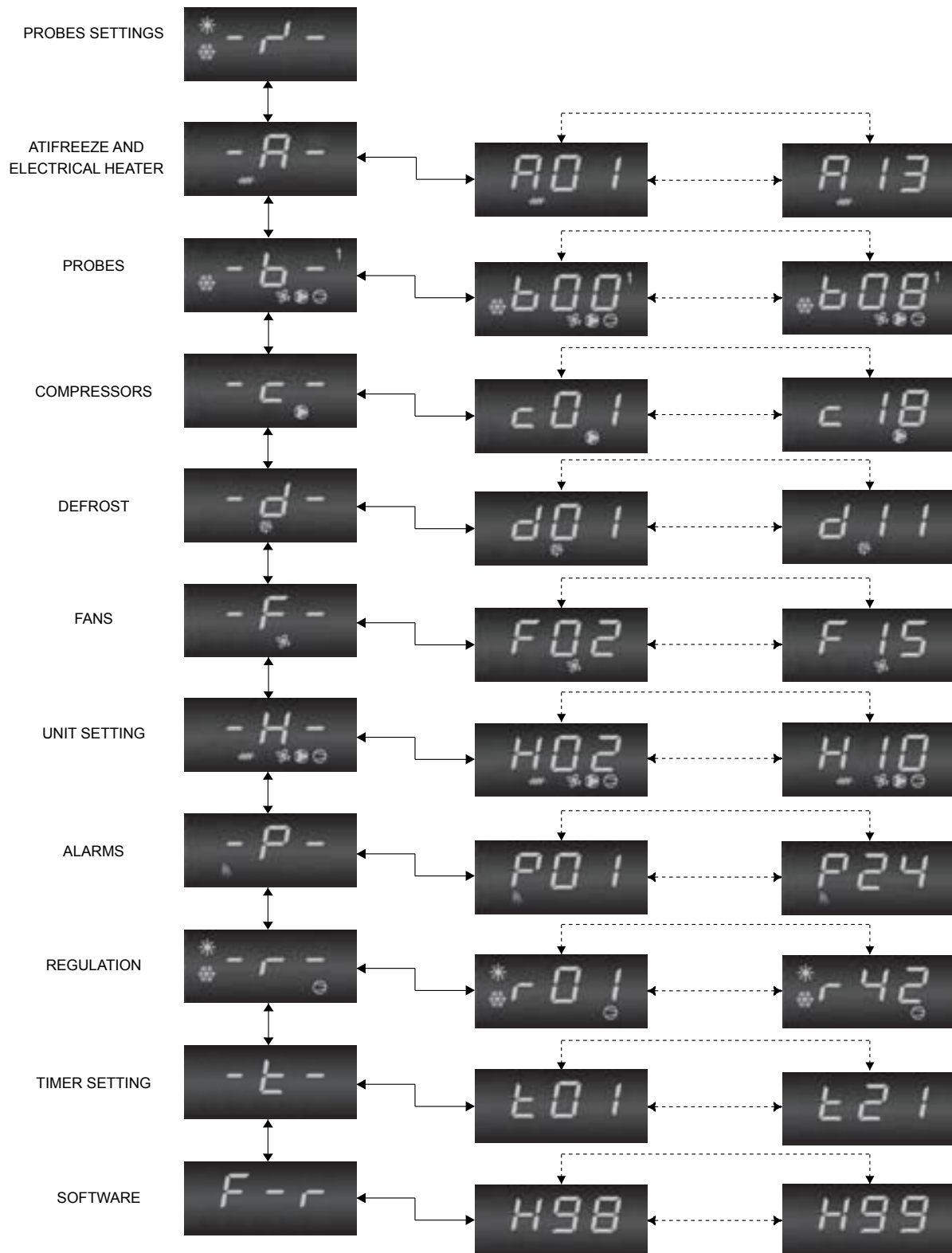

**NOTES:**

- a) The parameters that have been modified without being confirmed using the “ Sel ” button, return to the previous value.
- b) If no operations are performed on the keypad for 60 seconds, the controller exits the parameter editing menu by timeout and the changes are cancelled.

# REGULATION

## 1.- ECOLEAN

Inlet water temperature is thermostatically controlled via set point and tolerance range (differential) as shown in the following diagrams:

### 1.1- COOLING OPERATING MODE

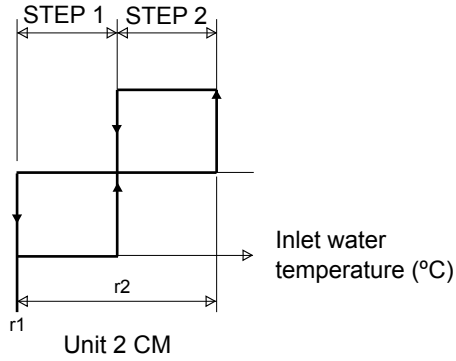

### 1.2- HEATING OPERATING MODE

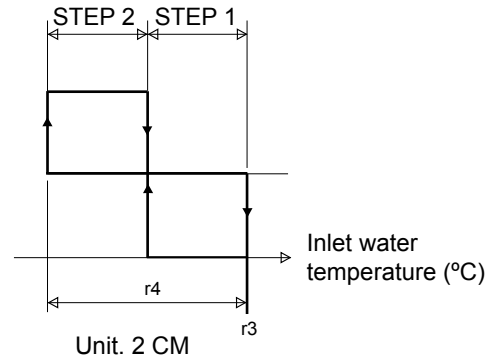

### 1.3- AFFECTED PARAMETERS

Par.	DESCRIPTION	VALVE UNIT 1CM.			VALVE UNIT 2CM.			VALVE UNIT 3CM.			VALVE UNIT 4CM.		
		MIN.	MAX.	DEF.	MIN.	MAX.	DEF.	MIN.	MAX.	DEF.	MIN.	MAX.	DEF.
r1	Cooling set point	10	22	11	9	22	10	8	22	9	8	22	9
r2	Cooling differential.	0.3	50	2	0.3	50	3	0.3	50	4	0.3	50	4
r3	Heating set point.	20	43	41	20	43	42	20	43	43	20	43	43
r4	Heating differential	0.3	50	2	0.3	50	3	0.3	50	4	0.3	50	4

## 2.- AIRCOOLAIR

Ambient (or return air duct) temperature is thermostatically controlled via set point and tolerance range (differential) as shown in the following diagrams:

### 2.1- AUTOMATIC MODE (Heat pump)

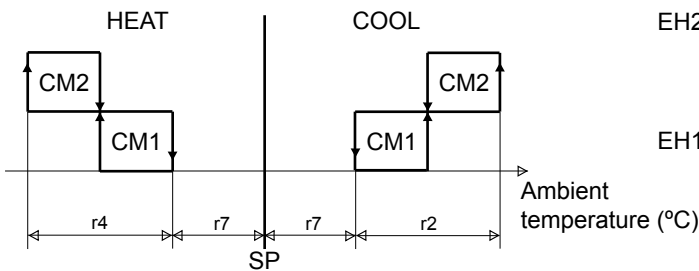

### 2.2- AUTOMATIC MODE (Cooling only+Electrical heater)

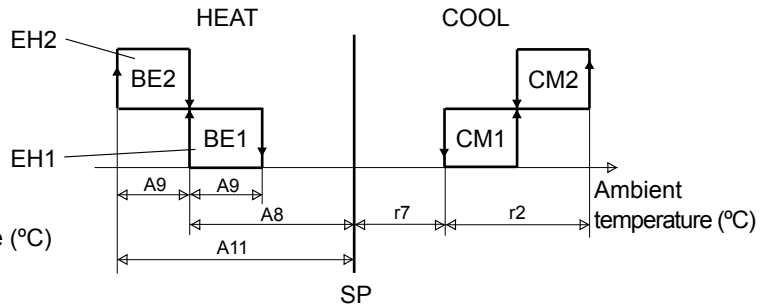

### 2.3- AFFECTED PARAMETERS

Par.	DESCRIPTION	UNIT 1 COMPRESSOR			UNIT 2 COMPRESSORS			UNIT 3 COMPRESSORS		
		MIN.	MAX.	DEF.	MIN.	MAX.	DEF.	MIN.	MAX.	DEF.
SP	Set point (DC40).	8	32	23	8	32	23	8	32	23
r2	Cooling differential.	0.3	50	1	0.3	50	2	0.3	50	4
r4	Heating differential.	0.3	50	1	0.3	50	2	0.3	50	4
r7	Dead zone.	0.3	50	0.5	0.3	50	0.5	0.3	50	0.5
A8	SP E.H. 1 cool / SP E.H. 1 heat	0	20	1.5/2.5	0	20	1.5/3.5	0	20	1.5/4.5
A9	Differential E.H.	0.3	50	1	0.3	50	1	0.3	50	1
A11	SP E.H. 2 cool.	0	20	2.5	0	20	2.5	0	20	2.5

## 3.- AIRCUBE

Aircube's regulation is performed by digital inputs. (see section 7, advanced functions, for more details).

## ADVANCED FUNCTIONS

### 1.- REMOTE ON/OFF

This function allows you to turn on/turn off the unit by a simply remote contact (contacts 95-96).  
Close contact = ON; Open contact = OFF.

### 2.- REMOTE CHANGEOVER WINTER/SUMMER

On heat pump units (also in Aircoolair cooling only + electrical heater), it is possible to select cooling or heating mode by a remote contact (contacts 97-98).

Close contact = Cooling.; Open contact = Heating.  
To activate this function set parameter **H06=1**.



#### WARNING

In Aircoolair units, if the automatic mode has been selected by DC40, remote changeover doesn't work.

### 3.- DYNAMIC SET POINT

**OPTION**

With this function, which needs to incorporate an additional outdoor temperature probe, it's possible to have a dynamic adjustment to the set point based on ambient temperature.

The set point value can be increased or decreased when the external conditions are more advantageous, so an extra energy saving can be achieved.

Dynamic setpoint must be activated in the factory.

User must set the parameters as shown in the graphics below:

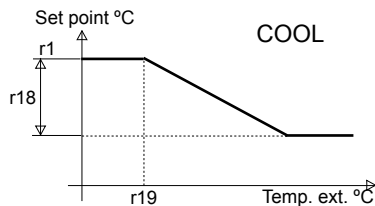

$$SP = r1 + (T.ext. - r19) \times r17$$

EXAMPLE

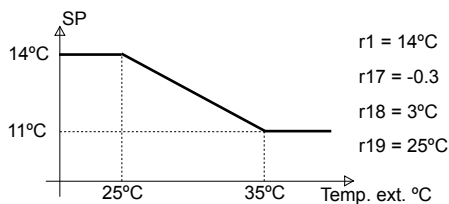

$r1 = 14^{\circ}\text{C}$   
 $r17 = -0.3$   
 $r18 = 3^{\circ}\text{C}$   
 $r19 = 25^{\circ}\text{C}$

#### ECOLEAN

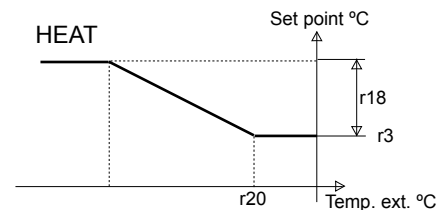

$$SP = r3 + (T.ext. - r20) \times r31$$

EXAMPLE

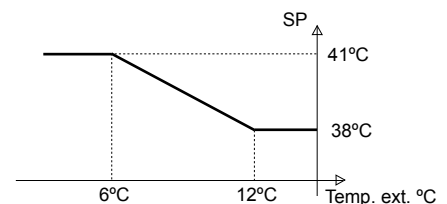

$r3 = 38^{\circ}\text{C}$   
 $r18 = 3^{\circ}\text{C}$   
 $r20 = 12^{\circ}\text{C}$   
 $r31 = -0.5$

#### AIRCOOAIR

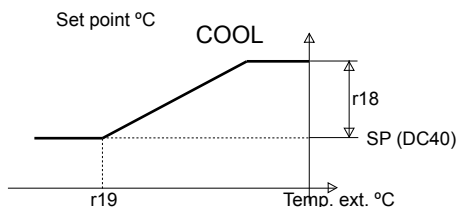

$$SP = SP(DC40) + (T.ext. - r19) \times r17$$

EXAMPLE

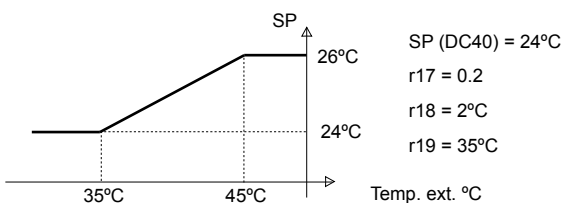

$SP(DC40) = 24^{\circ}\text{C}$   
 $r17 = 0.2$   
 $r18 = 2^{\circ}\text{C}$   
 $r19 = 35^{\circ}\text{C}$

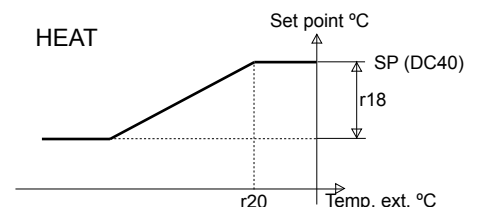

$$SP = SP(DC40) + (T.ext. - r20) \times r31$$

EXAMPLE

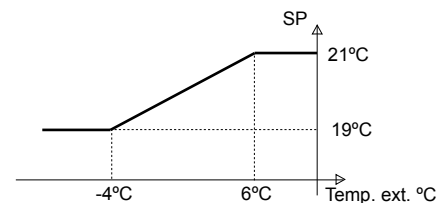

$SP(DC40) = 21^{\circ}\text{C}$   
 $r18 = 2^{\circ}\text{C}$   
 $r20 = 6^{\circ}\text{C}$   
 $r31 = 0.2$

## ADVANCED FUNCTIONS

### 4.- BMS COMMUNICATIONS

**OPTION**

Since the unstoppable growing trend of Building Automation, driven by the powerful ever evolving connectivity, controller climatic 40 offers the possibility to communicate to Building Management Systems (BMS) via Modbus protocol.

Modbus standard interface is integrated in the control, so you don't need any sort of gateway, router, etc.

In order you to connect to RS485 serial line we provide, as optional, TTL-RS485 converter for Ecolean and Aircube units.

Aircoolair units don't need the converter (it's integrated) but they need ambient or duct remote sensor option.

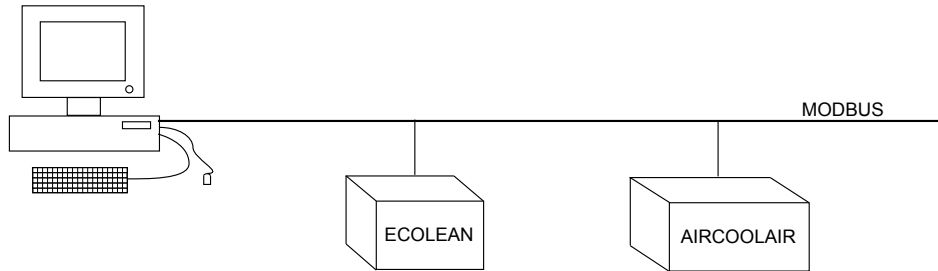

For further information, please see BMS communication manual.

### 5.- TIME BANDS PROGRAM (Ecolean)

Controller Climatic 40 allows to program 2 time bands every day, each one with a different set point.

Settings parameters are explained in the following table:

	COOLING		HEATING		
	TIME	SET POINT	TIME	SET POINT	
1 <sup>st</sup> TIME BAND	Rest of the day		Rest of the day		
2 <sup>nd</sup> TIME BAND	Start	(hour:minutes) <b>t06:t07</b>	r21	Start	(hour:minutes) <b>t10:t11</b>
	End	(hour:minutes) <b>t08:t09</b>		End	(hour:minutes) <b>t12:t13</b>

EXAMPLE (Cooling):

HOUR	Monday	Tuesday	Wednesday	Thursday	Friday	Saturday	Sunday
8:00-18:00	11°C	11°C	11°C	11°C	11°C	11°C	11°C
18:00-8:00 (t06:t07-t08-t09)	16°C	16°C	16°C	16°C	16°C	16°C	16°C



#### WARNING

Set internal clock before programming time bands (t01=hour, t02=minutes, t03=day, t04=month, t05=year).  
To deactivate time bands program, set start time = end time.

## ADVANCED FUNCTIONS

### 6.- LOW NOISE

This function is available only in the following units:

ECOLEAN	EAC + kit -15°C y EAR 251-812 SM
AIRCOOLAIR	ANCM + kit -15°C y ANHM 22E-86D
AIRCUBE	KSCM + kit -15°C y KSHM 22E-86D

This function moves the condensing pressure set point so as to lower the fan speed and consequently reduce noise (specifically at night). If low noise is active in cooling, the condenser control set points are increased by 5° bar. If low noise is active in heating, the set points are reduced by 1° bar.

Set **F15=3** to activate this function.

Furthermore set the following parameters:

COOLING			HEATING		
TIME		FAN	TIME		FAN
Rest of day		Standard	Rest of day		Standard
Start	(hour:minutes) t14:t15	LOW NOISE	Start	(hour:minutes) t18:t19	LOW NOISE
End	(hour:minutes) t16:t17		End	(hour:minutes) t20:t21	

Low noise cooling mode shift is illustrated in the following picture.

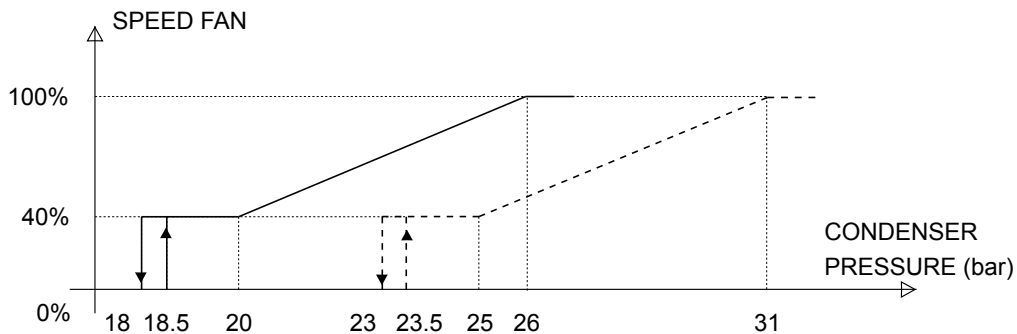

### 7.- ANALOGIC / DIGITAL INPUT

PROBES TABLE

PROBE	ECOLEAN		AIRCOOLAIR		AIRCUBE	
	EAC	EAR	ANCM	ANHM	KSCM	KSHM
DC40			Ambient temperature			
b1	Inlet water temperature		Return or remote ambient temperature **			
b2	Outlet water temperature		1 <sup>st</sup> Circuit evaporator temperature			
b3*	1 <sup>st</sup> Circuit condenser temperature	Temperatura exterior **	1 <sup>st</sup> Circuit condenser temperature	Temperatura exterior **	1 <sup>st</sup> Circuit condenser temperature	
b4	Outlet temperature **	1 <sup>st</sup> Circuit condenser pressure	Outlet temperature **	1 <sup>st</sup> Circuit condenser pressure		1 <sup>st</sup> Circuit condenser pressure
b6			2 <sup>nd</sup> Circuit evaporator temperature			
b7*			2 <sup>nd</sup> Circuit condenser temperature		2 <sup>nd</sup> Circuit condenser temperature	
b8		2 <sup>nd</sup> Circuit condenser pressure		2 <sup>nd</sup> Circuit condenser pressure		2 <sup>nd</sup> Circuit condenser pressure

\* Except: EAC 1003-1103-1303-1403-1604-1804-2104 SM  
ANCM 112D-128D-152D.  
KSCM 112D-128D-152D-214D

\*\* Optional elements.

NOTE:

Optional kit could change probes settings.

## ADVANCED FUNCTIONS

### DIGITAL INPUT TABLE

DIGITAL INPUT	ECOLEAN		AIRCOOLAIR		AIRCUBE	
	EAC	EAR	ANCM	ANHM	KSCM	KSHM
ID1	Flow switch		Termal overload fan		ON/OFF	
ID2		Cool/Heat	Cool/Heat	Cool/Heat		Cool/Heat
ID3	High pressure circuit 1					
ID4	Low pressure circuit 1					
ID5	ON/OFF		ON/OFF		Step 1	
ID6					Step 3	
ID7					Step 2	
ID8	High pressure circuit 2					
ID9	Low pressure circuit 2					
ID10					Step 4	

## 8.- TIMING AND DELAYS

### COMPRESSOR

In order to protect compressors from destructively cycling on and off, following protection delays have been set:

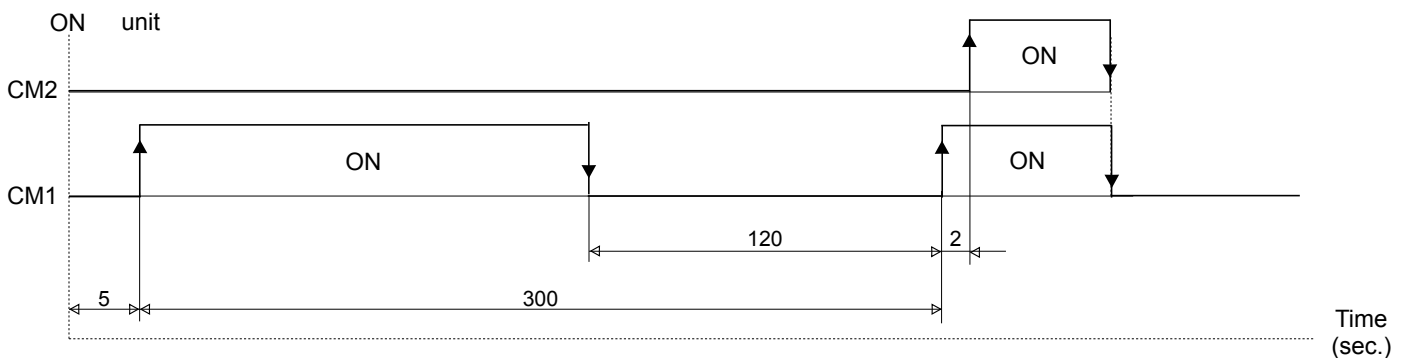

### COMPRESSOR- WATER PUMP (ECOLEAN)

In both heating and cooling modes, the compressors start 150 seconds after the water pump has started in order to stabilize the water system.

In addition to that, the water pump stops 4 minutes later than last compressor has stopped, in order to take advantage of the remaining thermal energy in the exchanger.

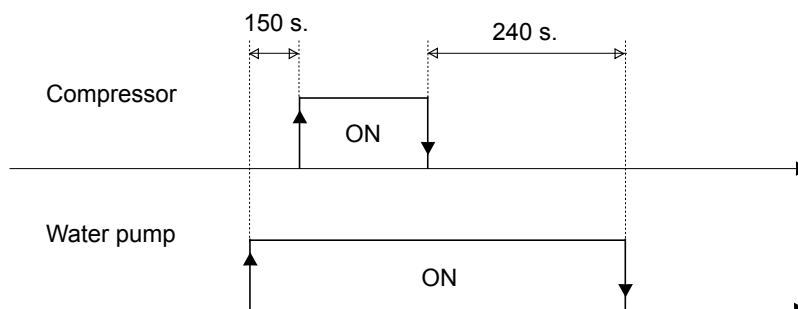

## ADVANCED FUNCTIONS

### WATER PUMP- WATER FLOW SWITCH (ECOLEAN)

Water flow switch assures that water pump does not work when there is no water flow. There is a by-pass during the first 150 seconds of water pump operation because of water flow switch signal. When the alarm has been activated, water pump is stopped. Water pump starts again every 90 seconds during a time of 150 seconds, to try to reset the alarm. This procedure is repeated 5 times and after that the pump remains stopped until the alarm does not reset manually.

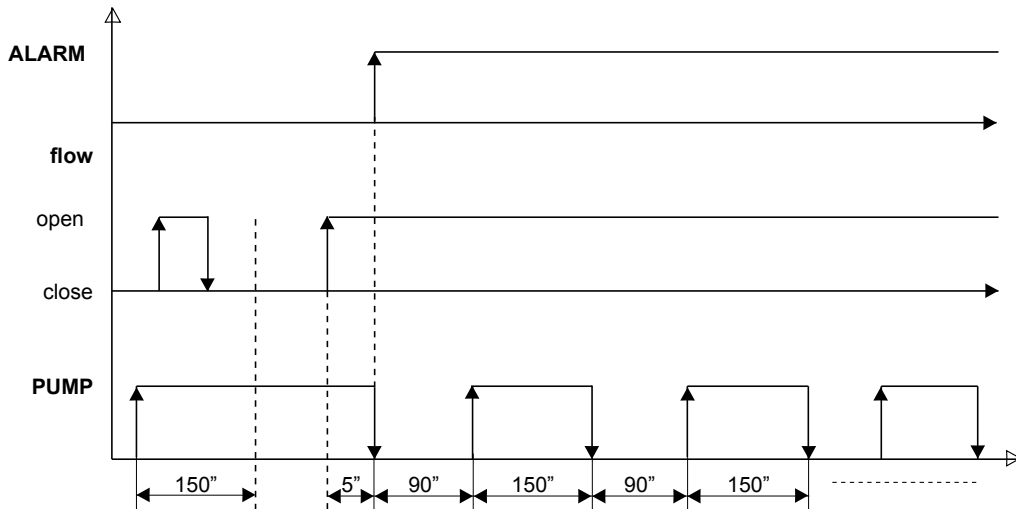

### 9.- DEFROST

The defrosting process is activated during heating mode in heat pump units, when the outside temperature is low and the outdoor coil could become frozen. To melt the ice the defrosting function will switch the unit to cooling operation for a short period. During defrosting mode the low pressure is at minimum level, consequently the pressure switch is disabled in this mode. Defrost cycle is illustrated in the following picture.

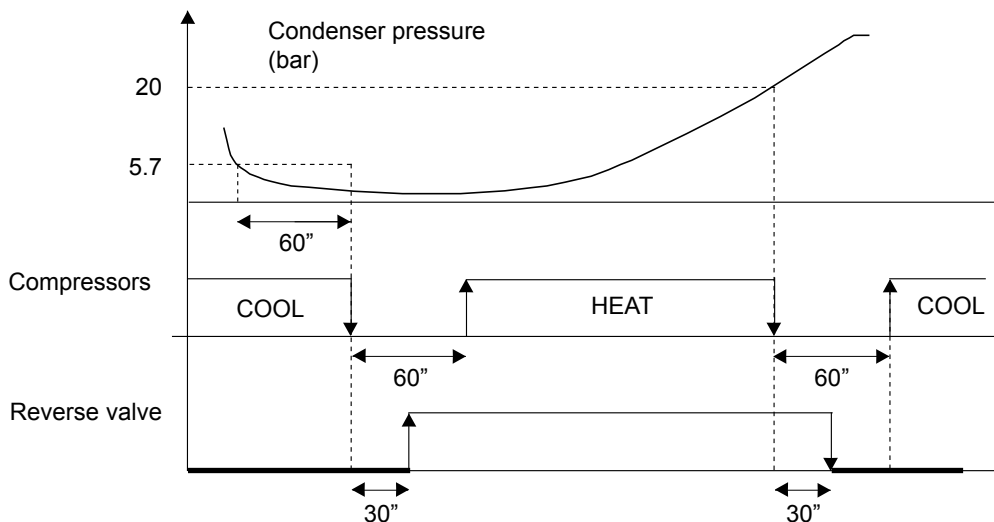

If the pressure does not reach the 20 bars before 8 minutes from the beginning of defrost cycle, the cycle finishes because of maximum time and in the display appears "dF1" or "dF2" (according to the circuit).

Time between two defrost cycles for the same circuit: 40 minutes. Time between two defrost cycles of both circuits: 10 minutes.



## ADVANCED FUNCTIONS

### 10.- CONDENSER FAN SPEED CONTROL

The function of the fan speed control is to prevent very low condensing temperatures during cooling mode operation between 0°C and 46°C outside temperatures.

Depending on the unit, this function could be:

#### 1.1.- PROPORTIONAL CONTROL BASED ON PRESSURE

Models: ECOLEAN: EAC + kit -15°C and EAR 251-812 SM  
 AIRCOOLAIR: ANCM + kit -15°C and ANHM 22E-86D  
 AIRCUBE: KSCM + kit -15°C and KSHM 22E-86D

In this case, it is a proportional fan speed control, which varies the fan voltage supplied to the fan.

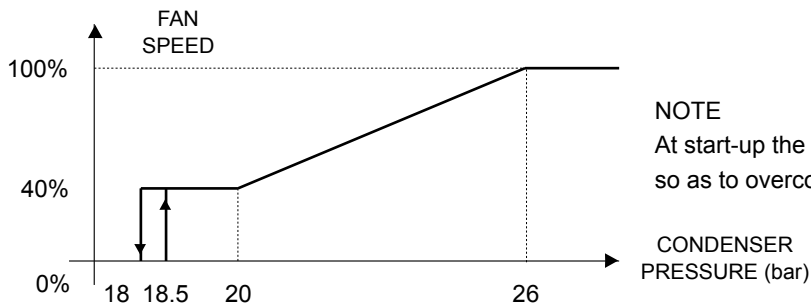

#### NOTE

At start-up the fan works at maximum speed for 20 seconds, so as to overcome the mechanical inertia of the motor.

#### 1.2.- PROPORTIONAL CONTROL BASED ON PRESSURE TEMPERATURE

Models: ECOLEAN: EAC 251-812 SM  
 AIRCOOLAIR: ANCM 22E-86D  
 AIRCUBE: KSCM 22E-86D

In this case too, it is a proportional fan speed control, which varies the fan voltage supplied to the fan.

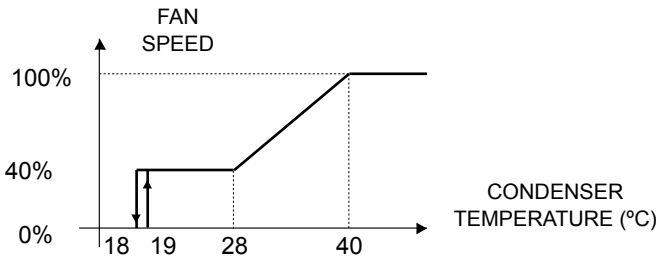

#### NOTA

At start-up the fan works at maximum speed for 20 seconds, so as to overcome the mechanical inertia of the motor. The same time is observed in reference to the start of the compressor (irrespective of the condensing temperature) in order to bring forward the sudden increase in pressure (which does not necessarily correspond to a likewise rapid increase in temperature in the area where the probe is located) and consequently to improve control.

#### 1.3.- ON/OFF CONTROL BASED ON PRESSURE

Models: ECOLEAN: EAR 1003-2104 SM  
 AIRCOOLAIR: ANHM 112D-152D  
 AIRCUBE: KSHM 112D-214D

ON/OFF, through the control and change between high and low fan speed through pressure switches.

The fans for these models incorporate 2 speeds. The fans work on high or low speed according to:

#### COOLING MODE:

The on/off and low/high fan speed is managed according to the condensing pressure. See the drawing below:

#### HEATING MODE (only heat pump units). The low/high fan speed is managed according to the ambient thermostat. See the drawing below:

The on/off and low/high fan speed is managed according to the ambient thermostat. See the drawing below:

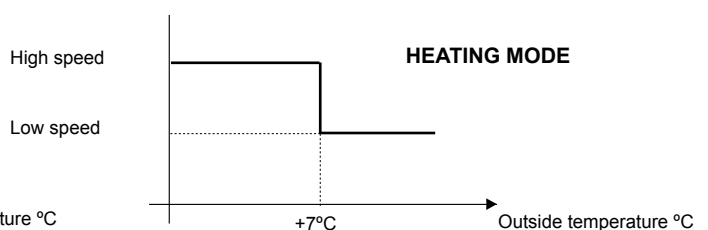
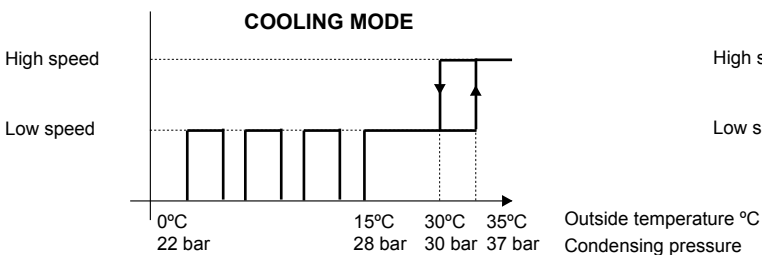

## ADVANCED FUNCTIONS

### 11.- FREE COOLING

#### OPTION

This option takes advantage of external conditions for cooling mode.

The freecooling is enabled when outdoor temperature is 1°C lower than indoor temperature and when the first one is:

- < 10°C, deactivate compressors and open completely air intake gate in order to refresh only by outdoor air (enough in this conditions).

- >10°C, open air intake gate and delay compressors, which turn on only in the case outdoor fresh air would not be sufficient to achieve comfort setpoint.

Picture below shows freecooling regulation.

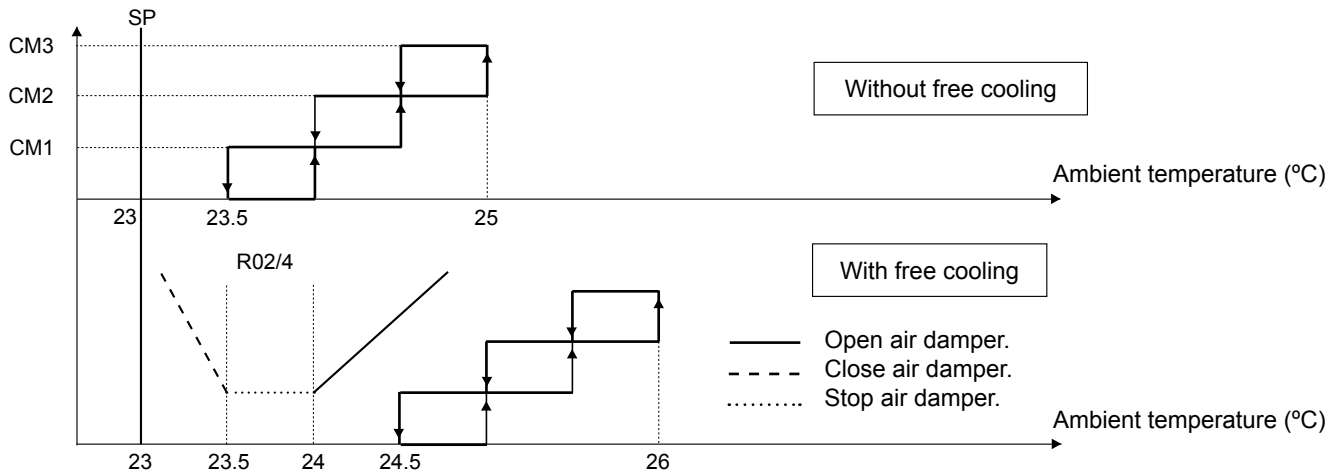

To get a constant air renovation, the damper can be partially open, according to the following values.

Par.	DESCRIPTION	Min.	Max.	Def.
r40	It indicates when to carry out the minimum opening of the damper.	0	9	0
	0= Never.			
	1= with freecooling.			
	2= with freeheating.			
	3= with freecooling and freeheating			
	4= always, except with freecooling y freeheating.			
	5= always, except with freeheating.			
	6= always, except with freecooling.			
	7= always			
	8= only for cooling mode.			
	9= only for heating mode.			
r41	% minimum percentage opening damper.	0	100	0

## PARAMETERS

PAR.	DESCRIPTION	MIN.	MAX.	VAR.	UD.	BY DEFAULT		
						ECOLEAN	AIRCOOLAIR	AIRCUBE
<b>Antifreeze and electrical heater</b>								
A01	Antifreeze alarm set point.	A7	A4	0.1	°C	3,0	2	-----
A02	Antifreeze differential.	0,3	122	0.1	°C	5,0	5	-----
A03	By-pass time for antifreeze alarm.	0	150	1	sec.	0	30	-----
A04	Antifreeze heater set point.	A1	R16	0.1	°C	4,5	-----	-----
A05	Antifreeze heater differential.	0,3	50	0.1	°C	1,0	-----	-----
A08	Auxiliary heater absolute set point (1 <sup>st</sup> step).	A1	R16	0.1	°C	35	-----	-----
	Auxiliary heater relative set point (1 <sup>st</sup> step).	0	20	0.1	°C	-----	1.5 (ANCM) 2.5 (ANHM 22E-43E) 3.5 (ANHM 52D-86D) 4.5 (ANHM 112D-152D)	-----
A9	Auxiliary heater differential.	0	20	0.1	°C	1	1	-----
A11	Auxiliary heater absolute set point (2 <sup>st</sup> step).	A1	R16	0.1	°C	33	-----	-----
	Auxiliary heater relative set point (1 <sup>st</sup> step).	0	20	0.1	°C	-----	2.5 (ANCM 52D-86D)	-----
A13	Lower discharge air temperature in freecooling.	A7	R16	0.1	°C	-----	7	-----
<b>Probes</b>								
b0	Config. of probe to be shown on the display: 0= probe B1.            1= probe B2 2= probe B3.            3= probe B4 4= probe B5.            5= probe B6 6= probe B7.            7= probe B8 8= Set point without compensation. 9= Dynamic set point with possible compensation. 10= Remote ON/OFF digital input status. 11= Terminal DC40 probe.	0	11	1	N	0	11	10
b1	Probe B1.	-----	-----	-----	°C			
b2	Probe B2.	-----	-----	-----	°C			
b3	Probe B3.	-----	-----	-----	°C			
b4	Probe B4.	-----	-----	-----	°C/bar			
b5	Probe B5.	-----	-----	-----	°C			
b6	Probe B6.	-----	-----	-----	°C			
b7	Probe B7.	-----	-----	-----	°C			
b8	Probe B8.	-----	-----	-----	°C/bar			
b21	Probe DC40.	-----	-----	-----	°C			
<b>Timing and delays</b>								
C01	Min. compressor ON time.	0	999	1	sec.	0	0	0
C02	Min. compressor OFF time.	0	999	1	sec.	120	120	120
C03	Delay between 2 starts of the same compressor.	0	999	1	sec.	300	300	300
C04	Delay between starts of the 2 compressor.	0	999	1	sec.	2	2	2
C05	Delay between 2 shut-downs of the 2 compressors.	0	999	1	sec.	0	0	0
C06	Delay at start up.	0	999	1	sec.	5	5	5
C07	Delay in switching on the compressor after switching on the pump.	0	999	1	sec.	150	0	0
C08	Delay in switching off the compressor after switching off the pump.	0	150	1	min.	4	0	0
C10	Compressor 1 timer.	0	8000	100	hours			
C11	Compressor 2 timer.	0	8000	100	hours			
C12	Compressor 3 timer.	0	8000	100	hours			
C13	Compressor 4 timer.	0	8000	100	hours			
C14	Operation timer threshold (0=not used).	0	100	100	hours	0	0	0
C15	Hour counter evaporator pump.	0	8000	100	hours			
C17	Minimum time between 2 pump starts.	0	150	1	min.	0	0	0
C18	Minimum pump/indoor fan ON time.	0	150	1	min.	0	1	0

## PARAMETERS

PAR.	DESCRIPTION	MIN.	MAX.	VAR.	UD.	BY DEFAULT		
						ECOLEAN	AIRCOOLAIR	AIRCUBE
<b>Defrost</b>								
d01	Defrosting cycle activation.	0	1	1	flag	1	1	1
d03	Start defrosting pressure.	1	D04	0.1	bar	5.7	5.7	5.7
d04	End defrosting pressure.	D03	/12	0.1	bar	25	25	25
d05	Min. time to start a defrosting cycle.	10	150	1	sec.	60	60	60
d06	Min. duration of a defrosting cycle.	0	150	1	sec.	0	0	0
d07	Max. duration of a defrosting cycle.	1	150	1	min.	8	8	8
d08	Delay between 2 defrosting cycle requests with in the same circuit.	10	150	1	min.	40	40	40
d09	Defrosting delay between the 2 circuits.	0	150	1	min.	10	10	10
<b>Fan</b>								
F02	Fan operating mode: 0= Always ON. 1= Depending ON compressor (in parallel operating mode). 2= Depending ON compressors in ON/OFF control. 3= Depending ON compressors in speed control mode.	0	3	1	int.	1 (EAC 1003-2104) 2 (EAR 1003-2104) 3 (EAC/EAR 251-812)	1 (ANCM 112D-152D) 2 (ANHM 112D-152D) 3 (ANCM/HM 22E-86D)	1 (KSCM 112D-214D) 2 (KSHM 112D-214D) 3 (KSCM/HM 22E-86D)
F05	Temp. value for min. speed cooling.	-40	176	0.1	°C	28	28	28
	Pressure value for min. speed cooling.	/11	/12	0.1	bar	20 (if F2=3) / 22 (if F2=2)	20 (if F2=3) / 22 (if F2=2)	20 (if F2=3) / 22 (if F2=2)
F06	Differential value for max. speed in cooling mode (temp).	0	50	0.1	°C	12	12	12
	Differential value for max. speed in cooling mode (pres).	0	30	0.1	bar	6	6	6
F07	Fan shut-down differential in cooling mode (temp).	0	50	0.1	°C	10	10	10
	Fan shut-down differential in cooling mode (pres).	0	F5	0.1	bar	2	2	2
F08	Temperature value for min. speed in heating mode.	-40	176	0.1	°C	30	30	30
	Pressure value for min speed cooling.	/11	/12	0.1	bar	12 (if F3=3) / 22 (if F3=2)	12 (if F3=3) / 22 (if F3=2)	12 (if F3=3) / 22 (if F3=2)
F09	Differential value for max. speed in heating mode (temp).	0	50	0.1	°C	1	1	1
	Differential value for max. speed in heating mode (pres).	0	30	0.1	bar	5	5	5
F10	Fan shut-down differential in heating mode (temp).	0	50	0.1	°C	0	0	0
	Fan shut-down differential in heating mode (pres).	0	F8	0.1	bar	13	13	13
F11	Fan starting time.	0	120	1		20	20	20
F15	Activation Low Noise: 0= Deactivate. 1= Activate only in cooling mode. 2= Activate only in heating mode. 3= Activate both in cooling and heating mode.	0	3	1	flag	0	0	0
F16	Differential Low Noise in cooling mode.	0	50	0.1	bar	5	5	5
F17	Differential Low Noise in heating mode.	0	50	0.1	bar	1	1	1
<b>Setting</b>								
H06	Activate remote change over: 0= Deactivate. 1= Activate.	0	1	1	flag	0	0	0 (KSCM) 1 (KSHM)
H07	ON/OFF remoto: 0= Deactivate. 1= Activate.	0	1	1	flag	1	1	1
H10	Serial address.	1	200	1	ud.	1	1	1
H23	Activate Modbus.	0	1	1	flag	0	0	0
H97	Expansion board software version.	0	999	1	flag			
H99	Software version.	0	999	1	flag			
<b>Alarms</b>								
P04	Enable part load in high pressure: 0= Capacity control deactivated. 1= Capacity control activated for high pressure. 2= Capacity control activated for low pressure. 3= Capacity control activated for high and low pres.	0	3	1	flag	1	1	1

## PARAMETERS

PAR.	DESCRIPTION	MIN.	MAX.	VAR.	UD.	BY DEFAULT		
						ECOLEAN	AIRCOOLAIR	AIRCUBE
Regulación								
r1	Cooling set point.	R13	R14	0.1	°C	11 (EAC/EAR 251-431) 10 (EAC/EAR 472-812) 9 (EAC/EAR 1003-2104)	24	----
r2	Differential in cooling mode.	0.3	50	0.1	°C	2 (EAC/EAR 251-431) 3 (EAC/EAR 472-812) 4 (EAC/EAR 1003-2104)	1 (ANCM/HM 22E-43E) 2 (ANCM/HM 52D-86D) 4 (ANCM/HM 112D-152D)	----
r3	Heating set point.	R15	R16	0.1	°C	41 (EAC/EAR 251-431) 42 (EAC/EAR 472-812) 43 (EAC/EAR 1003-2104)	22	----
r4	Differential in heating mode.	0.3	50	0.1	°C	2 (EAC/EAR 251-431) 3 (EAC/EAR 472-812) 4 (EAC/EAR 1003-2104)	1 (ACHM 22E-43E) 2 (ANHM 52D-86D) 4 (ANHM 112D-152D)	----
r7	Dead zone.	1	50	0.1	°C	-----	0.5	----
r17	Cooling compensation constant.	-5	5	0.1	-----	0	0	----
r18	Maximum distance from the set point.	0.3	20	0.1	°C	3	2	----
r19	Start compensation temperature in cooling mode.	-40	176	0.1	°C	25	35	----
r20	Start compensation temperature in heating mode.	-40	176	0.1	°C	12	6	----
r21	Second cooling set point.	R13	R14	0.1	°C	16	28	----
r22	Second heating set point.	R15	R16	0.1	°C	35	18	----
r23	Select automatic change over probe.	0	8	1	flag	0	0	----
r24	Automatic change over set point.	R15	R16	0.1	°C	-----	23	----
r25	Outside temp. set point to stop compressors.	-40	80	0.1	°C	-15	-15	-15
r31	Heating compensation constant.	-5	5	0.1	-----	0	0	0
Reloj								
t01	RTC hours.	0	23	1	-----			
t02	RTC minutes.	0	59	1	-----			
t03	RTC days.	1	31	1	-----			
t04	RTC month.	1	12	1	-----			
t05	RTC years.	0	99	1	-----			
t06	Start hours for 2 <sup>nd</sup> set point in cooling.	0	23	1	-----	0	0	0
t07	Start minutes for 2 <sup>nd</sup> set point in cooling.	0	59	1	-----	0	0	0
t08	End hours for 2 <sup>nd</sup> set point in cooling.	0	23	1	-----	0	0	0
t09	End minutes for 2 <sup>nd</sup> set point in cooling.	0	59	1	-----	0	0	0
t10	Start hours for 2 <sup>nd</sup> set point in heating.	0	23	1	-----	0	0	0
t11	Start minutes for 2 <sup>nd</sup> set point in heating.	0	59	1	-----	0	0	0
t12	End hours for 2 <sup>nd</sup> set point in heating.	0	23	1	-----	0	0	0
t13	End minutes for 2 <sup>nd</sup> set point in heating.	0	59	1	-----	0	0	0
t14	Start hours for 2 <sup>nd</sup> low noise cooling.	0	23	1	-----	0	0	0
t15	Start minutes for 2 <sup>nd</sup> low noise in cooling.	0	59	1	-----	0	0	0
t16	End hours for 2 <sup>nd</sup> low noise in cooling.	0	23	1	-----	0	0	0
t17	End minutes for 2 <sup>nd</sup> low noise in cooling.	0	59	1	-----	0	0	0
t18	Start hours for 2 <sup>nd</sup> low noise in heating.	0	23	1	-----	0	0	0
t19	Start minutes for 2 <sup>nd</sup> low noise in heating.	0	59	1	-----	0	0	0
t20	End hours for 2 <sup>nd</sup> low noise in heating.	0	23	1	-----	0	0	0
t21	End minutes for 2 <sup>nd</sup> low noise in heating.	0	59	1	-----	0	0	0



### WARNING

Default values could change according to the optional kits or improvements.

---

## SAFETY DEVICES

### ANTIFREEZE PROTECTION (ECOLEAN).

This protection is activated by the control of the unit when the outlet water temperature probe (b2), located inside the water exchanger, measures +4.5°C and deactivates when the outlet water temperature probe reaches +5.5°C again.

When the protection is activated occurs as follow:

- If the unit operating mode is STAND-BY : the water pump goes on, the same happens to electrical heater of water exchanger and electrical heater of water tank (if included).



DO NOT TURN OFF THE POWER TO THE UNIT. WHEN THE POWER IS OFF THE ANTI FREEZE PROTECTION WILL NOT OPERATE.

- If the unit is operating on cooling mode: feeds the electrical heater of water tank, the electrical heater of the water exchanger, and activates the hot gas injection valve (if the unit incorporates these options).

### LOW WATER TEMPERATURE ALARM (ECOLEAN).

This alarm activates when the outlet water temperature probe (IS1) measures a value of + 3 °C in standard unit.

Go stop the unit. The alarm could be reset when outlet water temperature reaches + 8°C in standard unit.

NOTE: Low water temperature options change the values of antifreeze protection and low water temperature alarm.

### ANTIFREEZE PROTECTION (AIRCOOLAIR).

The unit self-protects through a temperature probe located in the indoor piping, when this temperature goes down 2°C happens:

#### CASE WITHOUT FREECOOLING

- shut down compressors and antifreeze alarm goes on.
- La alarma se rearma automáticamente cuando la temperatura alcance los 7°C.

#### CASE WITH FREECOOLING

- Close air intake gate,
- Once the gate is completely closed, shut down compressors and antifreeze alarm goes on.

When the air intake gate is closing, if indoor piping temperature goes up 2°C, the gate stops and keeps the reached position; then, if the temperature achieves 7°C, the air damper starts opening otherwise, if the temperature goes down 2°C, the damper start closing again.

In addition to that, to prevent frozen air discharge when freecooling without compressors is working (outdoor temp.<10°C), if indoor piping temperature goes down 7°C, air intake gate starts to mix outdoor air with return air, increasing discharge air temperature.

## ASSEMBLY AND INSTALLATION INSTRUCTIONS

### DC40.

#### Installation instructions

1. Divide the top part of the instrument from the bottom part using a screwdriver as shown in Fig. 8.1.
2. Open the instrument with a “hinge” movement, pivoting the top part of the instrument and lifting the bottom part.

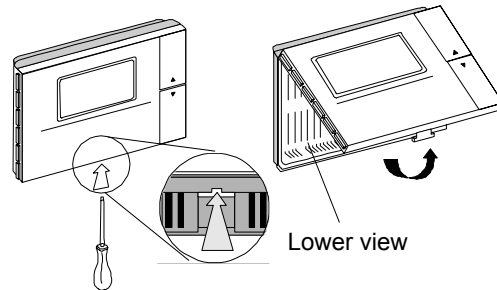

Fig. 8.1

3. Fix the rear part to the wall, taking care that the connection cables must pass through the hole in the centre of the rear shell. The distances between the fastening holes are designed so as to be able to fit the DC40 to a flush-mounting connection box compliant with the CEI C.431 - IEC 670 standards. If this is not available, use the fastening holes on the shell as a guide for drilling holes in the wall, and then use the kit of screws and plugs supplied.
4. Connect the cables to the terminals located on the shell as indicated in the same shell or in the electrical drawing.

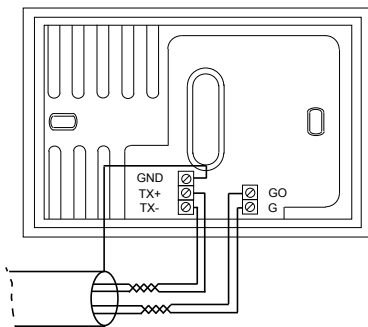

Fig. 8.2



Separate cables of the DC41 of inductive loads, cables and power devices (contactors, etc.) in order to prevent electromagnetic interferences.

Not include together power and communications cables

- Connect from the electrical box in the outdoor unit to DT41 device:
  - . 91 and 92 terminal blocks respectively to Tx+ and Tx - (Twisted pair of communications).
  - . 93 and 94 terminal blocks respectively to GO and G. (Twisted pair of power 24VAC).
  - . Borna 90 to GND. (shield).
- Type of cable: 2 twisted pairs AWG20

5. Once the installation is finished, fit the terminal on the shell pivoting the top part with a “hinge” movement and close it. When closing, make sure that the pins on the board fit into the corresponding terminals.

#### Installation warnings

- Disconnect the power supply before working on the DC40 during the assembly, maintenance and replacement operations.
- The terminal must be fastened to the wall so as to allow the circulation of air through the slits on the rear shell.
- Avoid installing the boards in environments with the following characteristics:
  - Avoid locations where the room temperature measurement may be altered.
  - Near doors leading to the outside.
  - Outside walls.
  - Exposure to direct sunlight or to conditioned air flow.
  - Strong magnetic and/or radio frequency interference (for example, near transmitting antennae).

## ASSEMBLY AND INSTALLATION INSTRUCTIONS

### DC41.

#### Installation instructions:

1. Pass the telephone cable through the hole in the rear of the case.
2. Fasten the rear of the case to the box using the round-head screws.
3. Connect the telephone cable to the RJ12 terminal of the DC41.
4. Rest the front panel on the rear of the case and fasten the assembly using the countersunk screws, as shown in Fig. 8.3.
5. Finally, apply the click-on frame.

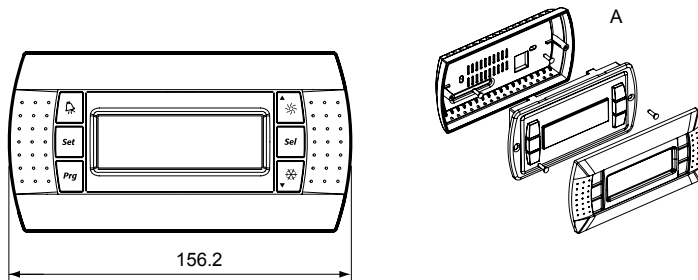

Fig. 8.3

#### Electrical connections:

1. Disconnect the power supply before working on the DC41 during the assembly, maintenance and replacement operations.
2. Make the connection between the power supply "DT41" and the terminal DC41 using the telephone cable (80 cm) supplied. If the cable is not long enough, use a pin-to-pin telephone cable with a maximum length of 10 m.

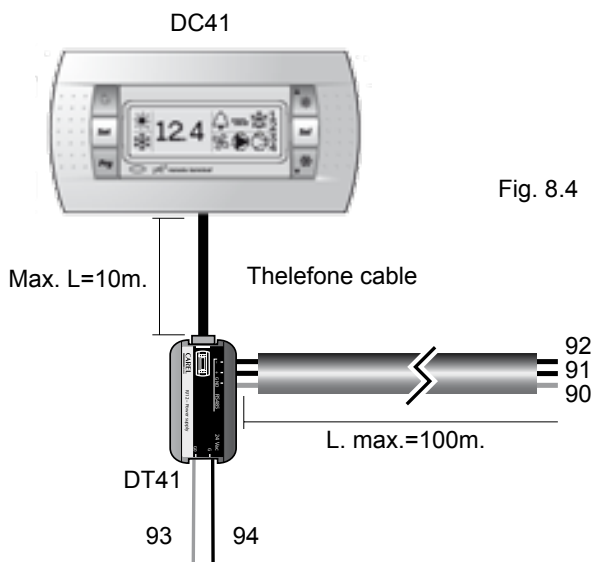

Fig. 8.4



Separate cables of the DC41 of inductive loads, cables and power devices (contactors, etc.) in order to prevent electromagnetic interferences.  
Not include together power and communications cables

- Connect from the electrical box in the outdoor unit to DT41 device:
  - . 91 and 92 terminal blocks respectively to Tx+ and Tx -. (Twisted pair of communications).
  - . 93 and 94 terminal blocks respectively to GO and G. (Twisted pair of power 24VAC).
  - . Borna 90 to GND. (shield).
- Type of cable: 2 twisted pairs AWG20



## ALARMS

### ALARMS/WARNINGS DISPLAY

The unit self-protects through safety devices; when any of these safety devices detect an anomaly, this is shown in Climatic 40 display and, only in Aircoolair units, also in DC41 display (even if with a different alarm code), in order to advise the operator.

Depending on the anomaly kind, Climatic 40 shows:

- Alarm. Serious anomaly. Have direct effect on the operation of the unit.
- Warning. Trivial anomaly. Have no direct effect on the operation of the unit.

The activation of an alarm brings about:

- Alarm code is shown on Climatic 40 display alternately with the main menu.
- Only in Aircoolair units, an alarm code (different from Climatic 40's one) is shown on DC40 display alternately with the main menu.
- A red bell appears on Climatic 40 display and alarm relay is activated.
- In some cases, it can block some of the outputs, stopping the unit, depending on the type of alarm.

The activation of a warning brings about:

- Warning code is shown only on Climatic 40 display alternately with the main menu.

### ALARM/WARNING RESET

Some alarms are automatically reset. When the cause is no longer present, they disappear from the display.

Others alarms are manually reset and, in addition to the disappearance of alarm conditions, they need a user-made reset as shown below:

CLIMATIC 40



5 Sec.

DC 40



3 Sec.

DC 41

5 Sec.



# ALARMS

## ALARMS/WARNINGS CODES

DISP CL40/ DC41	DISP DC40	DESCRIPTION	EFFECT	RE	ACTION
HP1	HP	High pressure switch alarm, circuit 1. This alarm may indicate the following problems: - High pressure switch protection. - Compressor stopped. - Indoor fan stopped (Aircoolair). - Excessive refrigerant charge. - Insufficient water flow in heating cycle (Ecolean).	Circuit 1 compressors stop	MAN.	Reset and check: - Coil is clean and not blocked. - Water flow on the heating cycle (Ecolean). - Outdoor fan during cooling cycle. - Indoor fan during heating cycle (Aircoolair). - Compressor protection. - Condenser air temperature is very high. - Refrigerant charge.
HP2		High pressure switch alarm, circuit 2. The same as previous alarm but this time referred to circuit 2.	Circuit 2 compressors stop	MAN.	The same as previous alarm but this time referred to circuit 2.
LP1	LP	Low pressure switch alarm, circuit 1. This alarm may indicate the following problems: - Low amount of refrigerant. - Low water flow in cooling cycle (Ecolean). - Outdoor coil blocked in heating cycle. - Outdoor fan stopped.	Circuit 1 compressors stop	AUTO	Reset and check: - Coil is clean and not blocked. - Water flow on the cooling cycle (Ecolean). - Outdoor fan during heating cycle. - Indoor fan during cooling cycle. - Fuses of the fan. - Evaporation air temperature is very low. - Check refrigerant charge. - Expansion valve.
LP2		Low pressure switch alarm, circuit 2. The same as previous alarm but this time referred to circuit 2.	Circuit 2 compressors stop	AUTO	The same as previous alarm but this time referred to circuit 2.
TP	T	Indoor fan thermal protection alarm. (Aircoolair only): - Fan thermal protection open. - Faulty power supply.	Unit stops	MAN.	Reset and check: - Fan. - Power supply.
TC1		Not used.	-----	-----	Call SAT.
TC2		Not used.	-----	-----	Call SAT.
LA	-----	Not used.	-----	-----	Call SAT.
FL	-----	Water flow switch alarm. It indicates low water flow in the unit. (Ecolean) only. After 5 automatic it comes to be a manual reset.	Unit stops	AUTO/ MAN.	- Check water circuit is not blocked. - Check water filter. - Check water pump operation.
FLb	-----	Not used.	-----	-----	Call SAT.
E1	E00	B1 probe error. Faulty probe or connection.	Unit stops	AUTO	Check connection of B1 probe (see electrical diagram), check the continuity and change the faulty component.
E2		B2 probe error. Faulty probe or connection.	Unit stops	AUTO	Check connection of B2 probe (see electrical diagram), check the continuity and change the faulty component.
E3		B3 probe error. Faulty probe or connection.	Unit stops	AUTO	Check connection of B3 probe (see electrical diagram), check the continuity and change the faulty component.
E4		B4 probe/pressure transducer error. Faulty probe or connection.	Unit stops	AUTO	Check connection of B4 probe/pressure transducer (see electrical diagram), check the continuity and change the faulty component.
E5		Not used.	-----	-----	Contactar con el SAT.
E6		B6 probe error. Faulty probe or connection.	Unit stops	AUTO	Check connection of B6 probe(see electrical diagram), check the continuity and change the faulty component.
E7		B7 probe error. Faulty probe or connection.	Unit stops	AUTO	Check connection of B7 probe (see electrical diagram), check the continuity and change the faulty component.
E8		B8 probe/pressure transducer error. Faulty probe or connection.	Unit stops	AUTO	Check connection of B8 probe/pressure transducer (see electrical diagram), check the continuity and change the faulty component.
Hcl-4	Hc	Warning. Compressor operating hour limit exceeded. Disabled by default.	-----	AUTO	Check: - Compressor operating hour (parameter C10). - Compressor operating hour limit (par. C15).
EPr	-----	Warning. Climatic 40 hardware error.	-----	AUTO	Call SAT.
Epb	-----	Warning. Climatic 40 hardware error.	Unit stops	AUTO	Call SAT.
ESP	ESP	Expansion board error.	Unit stops	AUTO	Check: - Green LED turned on inside the board. - J4-J9 connections (see electrical diagram). Call SAT.
EL1-2	-----	Warning. Condensing fan speed control hardware error.	Outdoor fan at maximum speed.	AUTO	- Check CFM board connections (see electrical diagram). Call SAT.
dF1-2	-----	Warning. Circuit 1-2 defrost ends due to maximum time (8 minutes).	-----	AUTO	
d1-2	-----	Warning. Circuit 1-2 defrosting.	-----	-----	

# ALARMS

## ALARMS/WARNINGS CODES

DISP CL40/ DC41	DISP DC40	DESCRIPTION	EFFECT	RE	ACTION
A1	A12	Antifreeze alarm. - ECOLEAN Outlet temperature < 3°C. Reset MAN.  - AIRCOOLAIR circuit 1 indoor piping temperature < 2°C. Reset AUTO.	-ECOLEAN compressors stop.  - AIRCOOLAIR Close freecooling air dumper and stops circuit 1 compressors 1	MAN/ AUTO	ECOLEAN: Reset and check: - Check the water filter. - Check water flow. - Check that the water pump is connected to power supply of the unit. AIRCOOLAIR: Check: - Indoor unit air filter. - Air damper correctly working.
A2		Antifreeze alarm, circuit 2. (Aircoolair only). Circuit 2 indoor piping temperature < 2°C. Reset AUTO.	Close freecooling air dumper and stops circuit 1 compressors 2	AUTO	Check: - Indoor unit air filter. - Air damper correctly working.
Ht	-----	Warning the high ambient temperature. Ambient temperature > 40°C.	-----	AUTO	Check ambient probe location; avoid places where the measurement of the ambient temperature by the internal sensor may be altered.
Lt	-----	Warning the low ambient temperature. Disabled by default.	-----	-----	Call SAT.
AHt	-----	Not used.	-----	-----	Call SAT.
HLt	-----	Not used.	-----	-----	Call SAT.
ELS	-----	Warning the low power supply. Power supply < 20.4V.	-----	AUTO	Check controller power supply = 24V (see electrical diagram).
EHS	-----	Warning the high power supply. Power supply > 26.4V.	Unit stops	AUTO	Check controller power supply = 24V (see electrical diagram).
Ed1	-----	Not used.	-----	-----	Call SAT.
Ed2	-----	Not used.	-----	-----	Call SAT.
SH1	-----	Not used.	-----	-----	Call SAT.
SH2	-----	Not used.	-----	-----	Call SAT.
nO1	-----	Not used.	-----	-----	Call SAT.
nO2	-----	Not used.	-----	-----	Call SAT.
LO1	-----	Not used.	-----	-----	Call SAT.
LO2	-----	Not used.	-----	-----	Call SAT.
HA1	-----	Not used.	-----	-----	Call SAT.
HA2	-----	Not used.	-----	-----	Call SAT.
EP1	-----	Not used.	-----	-----	Call SAT.
EP2	-----	Not used.	-----	-----	Call SAT.
ES1	-----	Not used.	-----	-----	Call SAT.
ES2	-----	Not used.	-----	-----	Call SAT.
EU1	-----	Not used.	-----	-----	Call SAT.
EU3	-----	Not used.	-----	-----	Call SAT.
Eb1	-----	Not used.	-----	-----	Call SAT.
Eb2	-----	Not used.	-----	-----	Call SAT.
L	-----	Not used.	-----	-----	Call SAT.
Ed1	-----	Not used.	-----	-----	Call SAT.
Ed2	-----	Not used.	-----	-----	Call SAT.
PH1	-----	Not used.	-----	-----	Call SAT.
PH2	-----	Not used.	-----	-----	Call SAT.
SUL	-----	Not used.	-----	-----	Call SAT.
tEr	OcH	Alarm, faulty communication between DC40 and Climatic 40. (Aircoolair only).	Unit stops	AUTO	- DC40 connections (see electrical diagrams). Call SAT.
	AcH	Generic alarm. Some active alarms on Climatic 40.	-----	-----	Check Climatic 40 alarm code and act by consequence.
	Ahu	Not used.	-----	-----	Call SAT.
	AtE	DC40 internal probe alarm. Faulty internal probe.	-----	-----	Call SAT.
	CEr	DC40 setting error.	-----	-----	Call SAT.
	UEr	DC40 hardware error.	-----	-----	Call SAT.

## ALARMS

### ALARM LOG

Climatic 40, has a log where significant events that stop (alarms) or limit (warnings) the operation of the unit, are saved.

In order to entry Alarm Log menu, do the same as explained in chapter 3 *MENU* in the paragraph *PARAMETERS EDITING MENU*, introducing the password 44 instead of 22.

Up to 25 events can be saved, highlighting in order: event code, start hours, start minutes, start day, start month, end hours, end minutes, end day, end month.



#### WARNING

The alarm log is only active and operative if the clock board is fitted.  
If there are no alarms saved, "noH" is displayed.



---

NOTES

---





[www.lennox europe.com](http://www.lennox europe.com)

**BELGIUM, LUXEMBOURG**  
[www.lennoxbelgium.com](http://www.lennoxbelgium.com)

**CZECH REPUBLIC**  
[www.lennox.cz](http://www.lennox.cz)

**FRANCE**  
[www.lennoxfrance.com](http://www.lennoxfrance.com)

**GERMANY**  
[www.lennoxdeutschland.com](http://www.lennoxdeutschland.com)

**GREAT BRITAIN**  
[www.lennoxuk.com](http://www.lennoxuk.com)

**NETHERLANDS**  
[www.lennoxnederland.com](http://www.lennoxnederland.com)

**POLAND**  
[www.lennoxpolska.com](http://www.lennoxpolska.com)

**PORTUGAL**  
[www.lennoxportugal.com](http://www.lennoxportugal.com)

**RUSSIA**  
[www.lennoxrussia.com](http://www.lennoxrussia.com)

**SLOVAKIA**  
[www.lennoxdistribution.com](http://www.lennoxdistribution.com)

**SPAIN**  
[www.lennoxspain.com](http://www.lennoxspain.com)

**UKRAINE**  
[www.lennoxrussia.com](http://www.lennoxrussia.com)

**OTHER COUNTRIES**  
[www.lennoxdistribution.com](http://www.lennoxdistribution.com)

Due to Lennox's ongoing commitment to quality, the Specifications, Ratings and Dimensions are subject to change without notice and without incurring liability.

Improper installation, adjustment, alteration, service or maintenance can cause property damage or personal injury.

Installation and service must be performed by a qualified installer and servicing agency.



MUL37E-0607 07-2007