

***LENNOX***<sup>®</sup>

# CLIMATIC<sup>™</sup> USER MANUAL



PROVIDING **GLOBAL SYSTEM SOLUTIONS**

**CHILLERS  
V 2.2**

# GENERAL CONTENTS

	Page
CONTROL AND REGULATION.....	2
OPTIONS .....	15
MACHINE FAULTS .....	22
CIRCUIT FAULTS .....	29
COMPRESSOR FAULTS .....	36
MISCELLANEOUS FAULTS.....	42
KP02 DIGITAL CONSOLE.....	50
VISUAL DISPLAY UNIT (VDU) KP 07 .....	55
ELECTRONIC CARD DATA .....	78

# CONTROL AND REGULATION

## SOMMAIRE

	Page
IDLE FUNCTION .....	3
CONTROL OF EVAPORATOR PUMPS .....	4
COLD THERMOSTAT .....	5
HOT THERMOSTAT .....	6
COLD REGULATION WITH GRADIENT .....	7
HOT REGULATION WITH GRADIENT .....	8
CONTROL OF COMPRESSORS .....	9
CONTROL OF CAPACITY REDUCTIONS FOR COLD REGULATION .....	10
CONTROL OF CAPACITY REDUCTIONS FOR HOT REGULATION .....	11
CONTROL OF ELECTRONIC EXPANSION VALVE .....	12
CONTROL OF CONDENSER FANS .....	13
SPECIFIC VALVES FOR SCREW COMPRESSORS .....	14

# IDLE FUNCTION

## Function

The idle function enables the machine to be stopped during certain times of the day or certain days of the week. Outside the idle period, the refrigeration unit operates normally, in accordance with its instructions.

## Description

Idle time is defined by 4 instructions (all included in the idle period) :

HDEBUTI ⇔ Start time of daily idle period  
HFINI ⇔ End time of daily idle period  
JDEBUTI ⇔ Start day of weekly idle period  
JFINI ⇔ End day of weekly idle period

As an option, the customer has the facility of confirming or stopping the idle function by remote control, by means of a hard contact connected to the logic input provided for this purpose (see wiring diagram). The variable associated with this entry is MAARI.

If MAARI = 0, idle times are ignored.

If MAARI = 1, idle times are processed.

Example:

The user wishes to stop the machine:

- from Monday to Friday, from 7 p.m. to 6 a.m. the next morning
- all day on Saturday and Sunday.

In this case the instructions should be set as follows :

HDEBUTI = 19  
HFINI = 6  
JDEBUTI = 7  
JFINI = 2

Note: By convention, Sunday is the first day of the week (Sunday = 1).

# CONTROL OF EVAPORATOR PUMPS

## Function

To control the flow of refrigerant in the evaporator

## Description

There are two possible types of regulation, defined by the variable C2POMPE.

- ❶ If C2POMPE = 0, the CLIMATIC controls one pump or none.
- ❷ If C2POMPE = 1, the CLIMATIC controls two pumps in normal / standby mode.

The user configures the C2POMPE parameter through switch 1 (or SW1) of CPU card.

### ☞ Case ❶ :

The pump POMPE1 is in service if all the following conditions are satisfied:

- ⇒ At least one on / off circuit n is ON (MAARn = 1). \*
- ⇒ The remote on / off switch for the machine is ON (MAARD = 1). \*
- ⇒ This is not an idle period (INOCCUP = 0). \*
- ⇒ The pump has been off for 1 minute or is already in operation.
- ⇒ There is no electrical fault on the pump (DELECP1 = 1).
- ⇒ There is no flow fault on the pump (DSDEB1 = 0).

\* Cette condition n'est pas prise en compte si l'option "relance hors gel de la pompe" a été choisie et la température d'air extérieur est inférieure à 2°C.

\* This condition is not taken into account if the "anti-freeze pump start-up" option has been selected and the outside air temperature is less than 2°C.

POMPE1 is always controlled by the CLIMATIC even if the installation pump is not electrically controlled by the refrigeration unit.

If the customer controls the pump, he/she must comply with the following procedures:

- Pump start-up 1 minute before confirming the remote on / off switch for the unit.
- Pump off at least 2 minutes after MAARD is switched to 0.

### ☞ Cas ❷ :

The pump POMPEk is in service if :

- ⇒ At least one on / off circuit n is ON (MAARn = 1). \*
- ⇒ The remote on / off machine is ON (MAARD = 1). \*
- ⇒ This is not an idle period (INOCCUP = 0). \*
- ⇒ Pump POMPEk has priority (PRIP = k-1).
- ⇒ The pump has been off for 1 minute or is already in operation.
- ⇒ There is no electrical fault on the pump (DELECPk = 1).
- ⇒ There is no flow fault on the pump (DSDEBk = 0).

\* This condition is not taken into account if the "anti-freeze pump start-up" option has been selected and the outside air temperature is less than 2°C.

The pump priority changes automatically once a week, on Monday at 6 p.m..

In the event of a fault occurring on the pump in service, the unit automatically transfers to the second pump, on condition that the latter is available.

Note: The CLIMATIC waits 2 minutes before stopping the pumps after a request to stop the machine or circuits, to avoid any risk of the evaporator freezing.

# COLD THERMOSTAT

## Function

To bring the temperature of the cooled fluid as close as possible to the set point by adapting the number of compressors in service to the heat load in operation.

## Description

The thermostat THER controls the switching on and off of compressors.

It is determined in accordance with the following parameters :

- TEEG ⇔ Chilled water input temperature (°C)
- CONSREG ⇔ Active instruction for output of chilled water (°C)  
This instruction is equal to CONSEA or CONSEB depending on the status of a logic input associated with the variable CHPCONS.  
Si CHPCONS = 0, CONSREG = CONSEA.  
Si CHPCONS = 1, CONSREG = CONSEB.  
(For regulation with air gradient, see page 7).
- DELTAT ⇔ Desired temperature difference between water input and output (°C)
- ENCL ⇔ Operating differential for a regulation stage (°C)  
This variable is calculated as follows:  
 $ENCL = (DELTAT / \text{No. Of compressors})$

Example of a machine with 4 compressors:

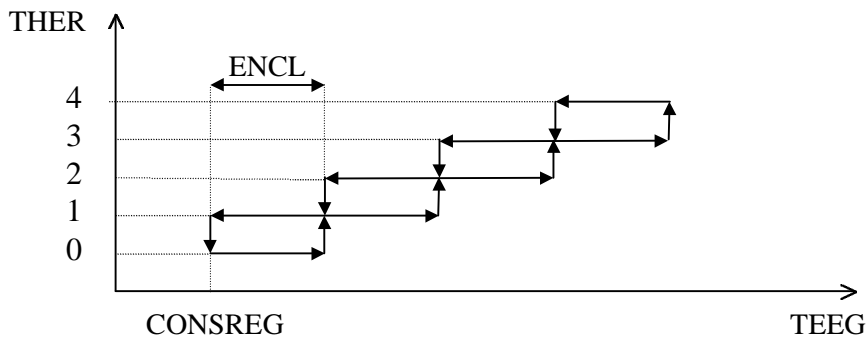

With CONSREG = 7°C  
et DELTAT = 5°C

⇒ ENCL = 1,25°C

Compressor start-up		Compressor stop	
THER	TEEG (°C)	THER	TEEG (°C)
0 ⇔ 1	8.25	4 ⇔ 3	10.75
1 ⇔ 2	9.5	3 ⇔ 2	9.5
2 ⇔ 3	10.75	2 ⇔ 1	8.25
3 ⇔ 4	12	1 ⇔ 0	7

**Remarque :** The thermostat is only authorised to increase by a stage if the following conditions are satisfied :

- ⇒ THER has not increased for at least 3 minutes.
- ⇒ The chilled water output temperature is greater than the set point.
- ⇒ The number of compressors in service is equal to the thermostat value.

# HOT THERMOSTAT

## Function

To bring the temperature of the heated fluid as close as possible to the set point by adapting the number of compressors in service to the heat load in operation.

## Description

The thermostat THER controls the switching on and off of compressors.

It is determined in accordance with the following parameters :

- TEEC ⇔ Hot water input temperature (°C)
- CONSREG ⇔ Active instruction for output of hot water (°C)  
This instruction is equal to CONSEA or CONSEB, depending on the status of a logic input associated with the variable CHPCONS.  
If CHPCONS = 0, CONSREG = CONSEA.  
If CHPCONS = 1, CONSREG = CONSEB.  
(For regulation with air gradient, see page 7).
- DELTAT ⇔ Desired temperature difference between water input and output (°C)
- ENCL ⇔ Operating differential for a regulation stage (°C)  
This variable is calculated as follows:  
 $ENCL = (DELTAT / \text{No. Of compressors})$

Example of a machine with 4 compressors:

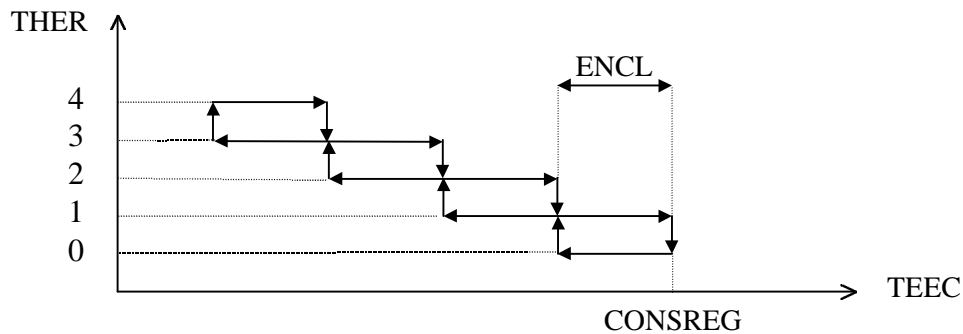

With CONSREG = 45°C  
and DELTAT = 5°C

⇒ ENCL = 1.25°C

Compressor start-up		Compressor stop	
THER	TEEC (°C)	THER	TEEC (°C)
0 ⇔ 1	43.75	4 ⇔ 3	41.25
1 ⇔ 2	42.5	3 ⇔ 2	42.5
2 ⇔ 3	41.25	2 ⇔ 1	43.75
3 ⇔ 4	40	1 ⇔ 0	45

**Note :** The thermostat is only authorised to increase by a stage if the following conditions are satisfied :

- ⇒ THER has not increased for at least 3 minutes.
- ⇒ The hot water output temperature is lower than the set point.
- ⇒ The number of compressors in service is equal to the thermostat value.

# COLD REGULATION WITH GRADIENT

## Function

To adapt the regulation set point to the outside air temperature, for improved counterbalancing of solar heat pick-up by the premises to be air conditioned.

## Description

Le calcul du point de consigne de régulation CONSREG se fait en fonction des paramètres suivants :

- TEA ⇔ Outside air temperature (°C)
- CONSA ⇔ 1st reference air temperature selected (°C)
- CONSAM ⇔ 2nd reference air temperature selected (°C)
- TEGI ⇔ Minimum chilled water temperature instruction (°C)
- CONSEG ⇔ Required water instruction for air instruction CONSA (°C)  
(CONSEG must be lower than +15°C).
- CONSEI ⇔ Required water instruction for air instruction CONSAM (°C)  
(CONSEI must be greater than TEGI+2°C).
- PENTE F ⇔ Regulation gradient (%)  
The gradient is calculated using the following equation:  
$$PENTE F = 100 \times ( CONSEI - CONSEG ) / ( CONSAM - CONSA )$$

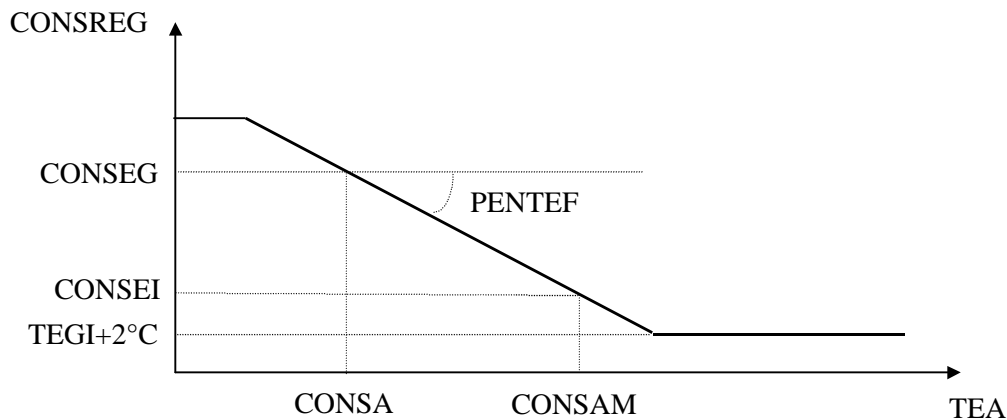

$$CONSREG = CONSEG + PENTE F \times ( TEA - CONSA ) / 100$$

### Example of regulation :

With    CONSA    = 20°C  
          CONSEG   = 10°C  
          CONSAM   = 35°C  
          CONSEI    = 6°C

⇒ PENTE F = -26.7 %

TEA (°C)	CONSREG (°C)
20	10
25	8,66
30	7,33
35	6



# HOT REGULATION WITH GRADIENT

## Function

To adapt the regulation set point to the outside air temperature for improved counterbalancing of heat loss to the outside from the premises to be heated.

## Description

The regulation set point CONSREG is calculated according to the following parameters :

- TEA ⇔ Outside air temperature (°C)
- CONSAI ⇔ 1st reference air temperature selected (°C)
- CONSA ⇔ 2nd reference air temperature selected (°C)
- TECS ⇔ Maximum hot water temperature instruction (°C)
- CONSEM ⇔ Required water instruction for the air instruction CONSAI (°C)  
(CONSEM must be less than TECS-2°C).
- CONSEC ⇔ Required water instruction for the air instruction CONSA (°C)  
(CONSEC must be greater than 25°C).
- PENTEC ⇔ Regulation gradient (%)  
The gradient is calculated using the following equation:  
$$\text{PENTEC} = 100 \times ((\text{CONSEC} - \text{CONSEM}) / (\text{CONSA} - \text{CONSAI}))$$

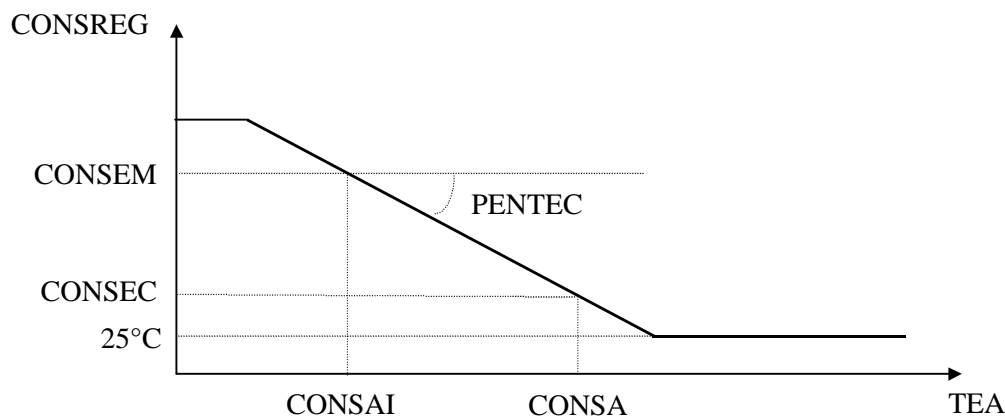

$$\text{CONSREG} = \text{CONSEC} + (\text{PENTEC} \times (\text{TEA} - \text{CONSA}) / 100)$$

### Example of regulation :

Avec    CONSAI    = -10°C  
           CONSEM    = 50°C  
           CONSA     = 15°C  
           CONSEC    = 30°C

⇒ PENTEC = -80 %

TEA (°C)	CONSREG (°C)
-10	50
-5	46
0	42
5	38
10	34
15	30

# CONTROL OF COMPRESSORS

## Function

The compressors are started up and stopped in the order which avoids the anti-short cycle, as far as possible, and evens out their operating times..

## Description

### ☞ Start-up and stopping order for compressors

This order is determined by a "FIFO" (first in, first out) rule. This function incorporates the automatic, instantaneous recording of a priority compressor which has become unavailable

### ☞ Compressor start-up and stopping

The compressor COMPmn starts up if all the following conditions are satisfied :

- ⇒ The water circulation pump received the order to operate at least 1 minute earlier.
- ⇒ The on / off switch for circuit n is ON (MAARn = 1).
- ⇒ The machine is available (DISPOM = 1).
- ⇒ Circuit n is available (DISPOCn = 1).
- ⇒ Compressor mn is available (DISPOmn = 1).
- ⇒ The regulation thermostat THER is greater than the number of compressors in service.
- ⇒ COMPmn is the compressor defined by the FIFO rule as the next one to start up.
- ⇒ COMPmn is not in anti-short cycle (ACCmn = 1).

The compressor COMPmn stops if at least one of the following conditions is satisfied :

- ⇒ The remote on / off switch for the machine is OFF (MAARD = 0).
- ⇒ The on / off switch for circuit n is OFF (MAARn = 0).
- ⇒ The machine is unavailable (DISPOM = 0).
- ⇒ Circuit n is unavailable (DISPOCn = 0).
- ⇒ Compressor mn is unavailable (DISPOmn = 0).
- ⇒ The regulation thermostat THER is less than the number of compressors in service and COMPmn is the compressor defined by the FIFO rule as the next one to be stopped.

		THER	0	1	2	3	4	3	4	3	2	1	2	3	2	3	4	3	2	1	0
<b>Compressor number</b>	<b>Last one started up</b>	-	1	2	3	4	-	1	-	-	-	2	3	-	4	1	-	-	-	-	-
	<b>Last one stopped</b>	-	-	-	-	-	1	-	2	3	4	-	-	1	-	-	2	3	4	1	-
	<b>In operation</b>	-	1	1 2	1 2 3	1 2 3 4	2 3 4	2 3 4 1	3 4 1	4 1	1	1 2	1 2 3	2 3	2 3 4	2 3 4 1	3 4 1	4 1	1	-	-

# CONTROL OF CAPACITY REDUCTIONS FOR HOT REGULATION

## Function

To adjust the hot water output temperature as closely as possible to the set point by adapting compressor capacity.

## Description

Capacity reduction valves are only available on semi-hermetic reciprocating or screw compressors.

On a machine with several compressors, only the last one started up can modify its capacity. The other compressors are maintained at full capacity.

The number of capacity reductions to be put into operation is defined by the thermostat THERR, in accordance with the following 2 parameters:

- TSEC ⇔ Hot water output temperature (°C)
- CONSREG ⇔ Chilled water instruction (°C)

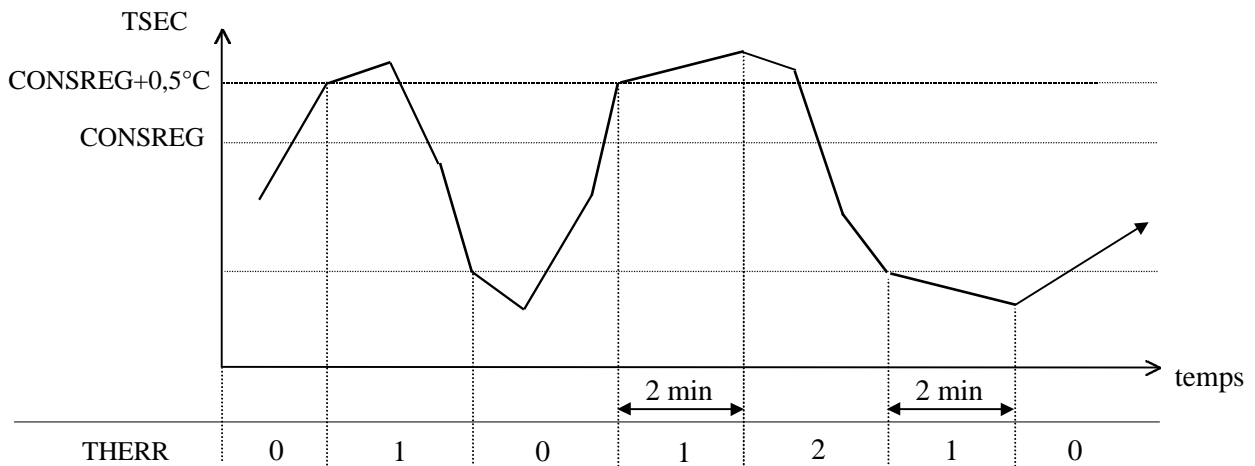

As soon as TSEC becomes greater than  $CONSREG+0.5^{\circ}C$ , capacity is reduced. As long TSEC remains above  $CONSREG + 0.5^{\circ}C$ , an additional capacity reduction cuts in (if applicable) every 2 minutes.

If at least one capacity reduction is in service, one is stopped as soon as TSEC is less than  $CONSREG - 1^{\circ}C$ . As long as the TSEC condition is satisfied, an additional capacity reduction is stopped every 2 minutes.

**Note :** At start-up, the compressors are maintained at reduced capacity for 1 minute.

# CONTROL OF CAPACITY REDUCTIONS FOR HOT REGULATION

## Function

To adjust the hot water output temperature as closely as possible to the set point by adapting compressor capacity.

## Description

Capacity reduction valves are only available on semi-hermetic reciprocating or screw compressors.

On a machine with several compressors, only the last one started up can modify its capacity. The other compressors are maintained at full capacity.

The number of capacity reductions to be put into operation is defined by the thermostat THERR, in accordance with the following 2 parameters:

- TSEC ⇔ Hot water output temperature (°C)
- CONSREG ⇔ Chilled water instruction (°C)

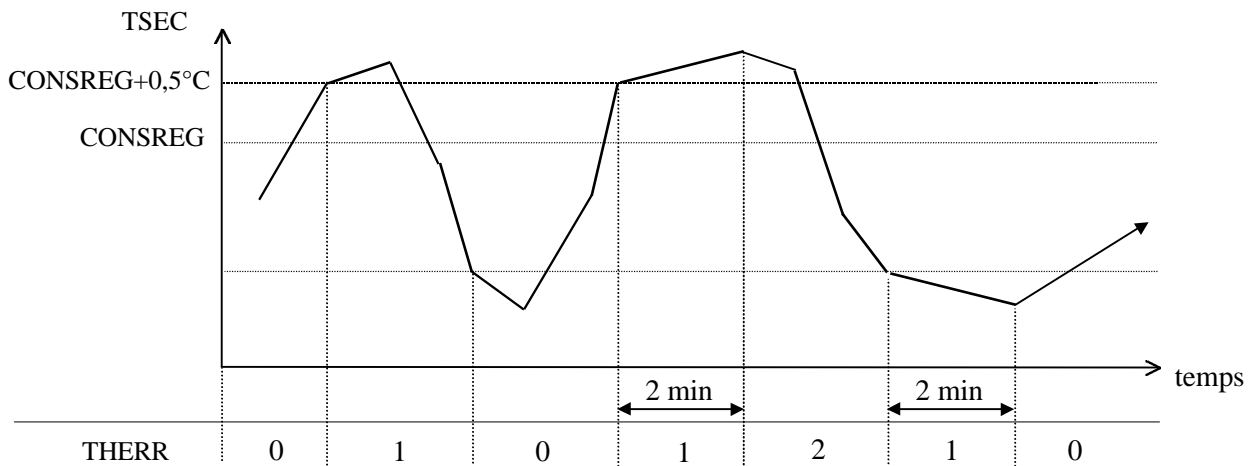

As soon as TSEC becomes greater than  $CONSREG + 0.5^{\circ}C$ , capacity is reduced. As long TSEC remains above  $CONSREG + 0.5^{\circ}C$ , an additional capacity reduction cuts in (if applicable) every 2 minutes.

If at least one capacity reduction is in service, one is stopped as soon as TSEC is less than  $CONSREG - 1^{\circ}C$ . As long as the TSEC condition is satisfied, an additional capacity reduction is stopped every 2 minutes.

**Note :** At start-up, the compressors are maintained at reduced capacity for 1 minute.

# CONTROL OF ELECTRONIC EXPANSION VALVE

## Function

To control correct filling of the evaporator with refrigerant in order to obtain highest efficiency, whilst protecting the compressor against slugging.

## Description

The expansion valve is controlled by Proportional + Integral + Derivative logic. The ideal theoretical opening RDETA<sub>n</sub> of the expansion valve on circuit n is determined and compared with the actual opening. Depending on the variation observed, an opening or closing order is issued to the expansion valve.

### ☞ Calculation of RDETA<sub>n</sub>

The opening to be achieved RDETA<sub>n</sub> depends on the following parameters :

SURCHD	⇔ Superheat instruction (°C)
TASP <sub>n</sub> -TBP <sub>n</sub>	⇔ Superheat measured on circuit n (°C)
RDETA <sub>n</sub>	⇔ Opening measured on expansion valve (°C)

I.e.  $\Delta e_t$  is the difference at time t between the measured superheat and the instruction:

$$\Delta e_t = (TASP_n - TBP_n) - SURCHD$$

$$RDETA_n = RDETA_n + K_p \cdot \Delta e_t + K_i \cdot \sum_{t=ni}^t \Delta e_t + K_d \cdot \sum_{t=nd}^t (\Delta e_t - \Delta e_{t-1})$$

Integral action      Derivative  
Proportional action

### ☞ Order issued to expansion valve

3 cas se présentent :

- ⇒ If  $RDETA_n > RDETA_n$ , the expansion valve must be heated ( $DET_n=1$ ) to open it to the desired opening.
- ⇒ If  $RDETA_n < RDETA_n$ , the expansion valve is not heated ( $DET_n=0$ ) so that it can close.
- ⇒ If  $RDETA_n = RDETA_n$ , the expansion valve is maintained at its current opening value by alternating start and stop heating operations successively.

**Note :** Before starting up the first compressor on the circuit, the expansion valve is preheated to an opening value calculated on the basis of the low pressure prevailing in the circuit. This procedure avoids any risk of slugging at compressor start-up.

# CONTROL OF CONDENSER FANS

## Function

To maintain as stable a condensation pressure as possible without fans cutting in too frequently.

## Description

The CLIMATIC calculates the number of ventilation stages THVn required for the proper functioning of each refrigeration circuit.

THVn depends on the following parameters :

- PTHPn ⇔ Condensation pressure in circuit n (abs. bar)
- TEA ⇔ Outside air temperature (°C)
- HPHAUT ⇔ High pressure limit (abs. bar)
- HPBAS ⇔ Low pressure limit (abs. bar)  
The minimum difference between HPHAUT and HPBAS is 5 bar.
- TEMPOV ⇔ Timing of raising or lowering of ventilation stage (s)

Setting instructions

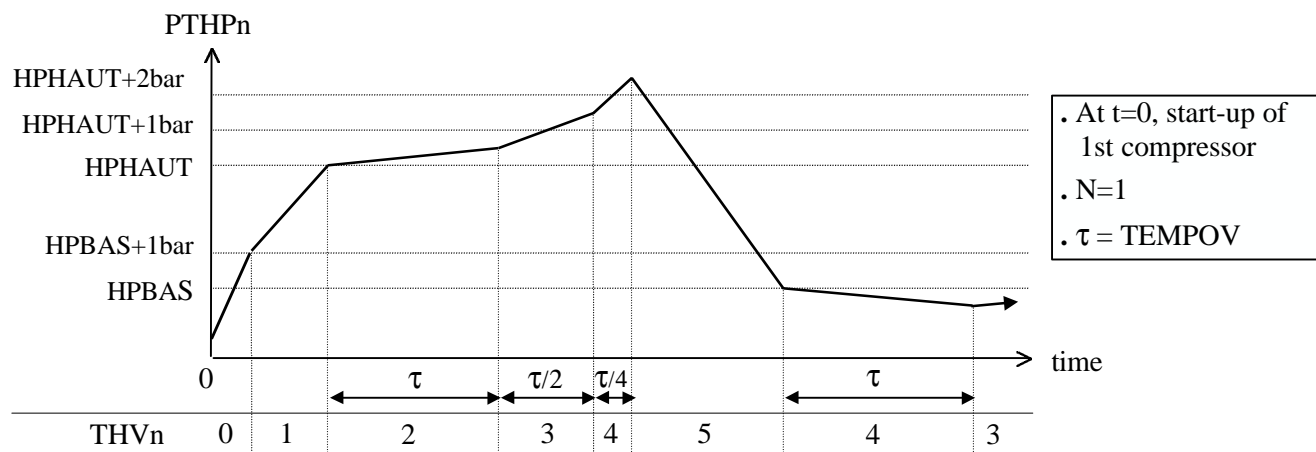

### Fan operation

At the start-up of the first compressor on the circuit, as soon as high pressure becomes greater than HPBAS+1bar, N fans are immediately started up (the number N depends on the outside air temperature).

When PTHPn exceeds HPHAUT, the thermostat is increased by one stage. If the pressure remains above HPHAUT, THVn continues to be increased by one unit every T (time interval) :

- . If  $HPHAUT < PTHPn < HPHAUT+1bar$ ,  $T = TEMPOV$
- . If  $HPHAUT+1bar < PTHPn < HPHAUT+2bars$ ,  $T = TEMPOV/2$
- . If  $PTHPn > HPHAUT+2bars$ ,  $T = TEMPOV/4$

### Turning off fans

Once PTHPn falls below HPBAS, THVn is reduced by one stage. As long as PTHPn remains below HPBAS, THVn continues to be decreased by 1 every TEMPOV (time interval).

**Note :** When stopping a ventilation stage relates to a 2-speed fan, switching from fast to slow speed is delayed by 5 seconds.

# SPECIFIC VALVES FOR SCREW COMPRESSORS

## Liquid injection valve using intermediate suction

### Function

To reduce the compressor discharge temperature thereby improving cooling on the compressor motor.

### Description

The liquid injection valve INJLmn is open if:

- . the compressor COMPmn is in operation
- and . the discharge temperature TREFmn is greater than 100°C or the economy valve ECOmn is opened.

INJLmn is kept open as long as:

- . the compressor COMPmn is in operation
- and . the discharge temperature TREFmn is greater than 90°C or the economy valve ECOmn is opened.

## Economy valve

### Function

To increase refrigerating capacity by increased sub-cooling of the liquid refrigerant output from the condenser.

### Description

The economy valve ECOmn is open if:

- . compressor COMPmn is in operation and at full capacity for 2 minutes
- and . the discharge temperature TREFmn is greater than
- and . high pressure in circuit n PTHPn is greater than P1.

ECOmn is kept open as long as:

- . compressor COMPmn is in operation and at full capacity
- and . the discharge temperature TREFmn is greater than -2°C
- and . high pressure in circuit n PTHPn is greater than P2.

	$\theta$ (°C)	P1 (absolute bar)	P2 (absolute bar)
R22	65	11,9	11,2
R134a	40	7,7	6,7
R407C	45	13,5	11,7

# OPTIONS

## CONTENTS

	Page
FREE-COOLING .....	16
HEAT RECOVERY .....	18
MANAGEMENT OF UNITS IN PARALLEL .....	19



# FREE-COOLING

## Function

To ensure refrigeration whilst optimising the use of free-cooling, thus limiting electrical consumption to a minimum.

## Description

### *Free-cooling outline diagram*

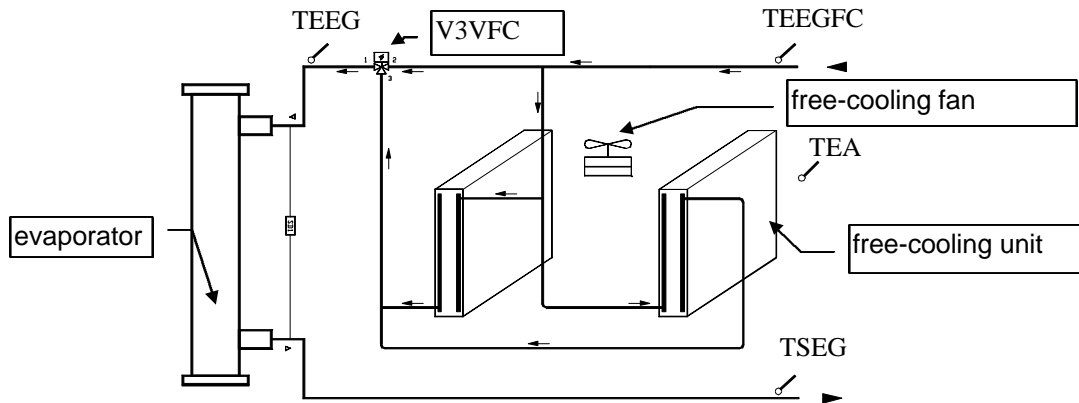

- TEEGFC ⇔ Temperature of chilled water input to free-cooling (°C)
- TEEG ⇔ Temperature of chilled water input to the evaporator (°C)
- TSEG ⇔ Chilled water output temperature (°C)
- TEA ⇔ Outside air temperature (°C)
- V3VFC ⇔ Three-way free-cooling valve

### *Control of the three-way free-cooling valve:*

V3VFC is fed if all the following conditions are satisfied :

- ⇒ TEEGFC is greater than the regulation instruction CONSREG.
- ⇒  $TEA < TEEGFC - 2^{\circ}\text{C}$ .
- ⇒ The chilled water circulation pump has been in operation for at least 30 seconds.
- ⇒ The three way valve has remained off for 3 minutes.
- ⇒ The free-cooling water input sensor is not defective.

V3VFC is kept connected as long as all following conditions are satisfied :

- ⇒ TEEGFC is not less than CONSREG.
- ⇒  $TEA < TEEGFC$ .
- ⇒ The pump is in operation.
- ⇒ The free-cooling water input sensor is not defective.

### *Control of free-cooling fans*

The number of ventilation stages required for the batteries is determined by the free-cooling thermostat THERFC. This parameter depends on the temperature of the water input to the evaporator TEEG and on the regulation instruction.

## FREE-COOLING (CONT'D)

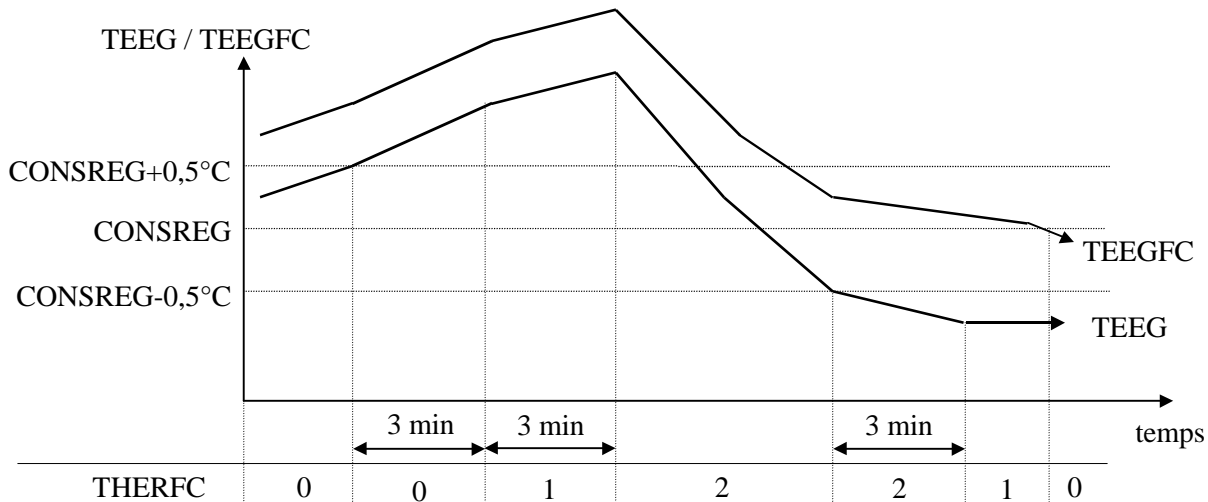

The thermostat is incremented by one stage if TEEG remains greater than CONSREG+0.5°C for over 3 minutes. As long as this condition on TEEG is satisfied, THERFC continues to be incremented by one stage every 3 minutes.

If TEEG remains lower than (CONSREG-0.5°C) the free-cooling thermostat is reduced by one stage every 3 minutes.

When TEEGFC falls below the set point, all ventilation stages are halted.

If the compressor regulation thermostat THER requires at least one stage of regulation whilst free-cooling is in service, the free-cooling thermostat is forced to its maximum.

The free-cooling fan n VENTFCn operates if:

- . THERFC  $\geq$  n
- and . V3VFC is in service.

### ☞ Authorisation of compressor start-up

Authorisation of compressor start-up, in parallel with free-cooling operation, is defined by the variable AUTOCP which is dependent on the following parameters :

- V3VFC  $\Leftrightarrow$  Three-way free-cooling valve
- THERFC  $\Leftrightarrow$  Free-cooling regulation thermostat
- THER  $\Leftrightarrow$  Compressor regulation thermostat

AUTOCP is set to 1 if :

- . THERFC is at its maximum and TEEG is greater than CONSREG for over 3 minutes
- or . V3VFC is not fed.

AUTOCP is kept at 1 as long as :

- . THER is strictly positive
- or . V3VFC is not fed.

# HEAT RECOVERY

## Function

On air units with heat recovery condenser, to maintain the hot water output temperature as close as possible to the instruction, whilst adapting the air condenser capacity to the excess thermal capacity to be discharged.

## Description

### Outline diagram of heat recovery process

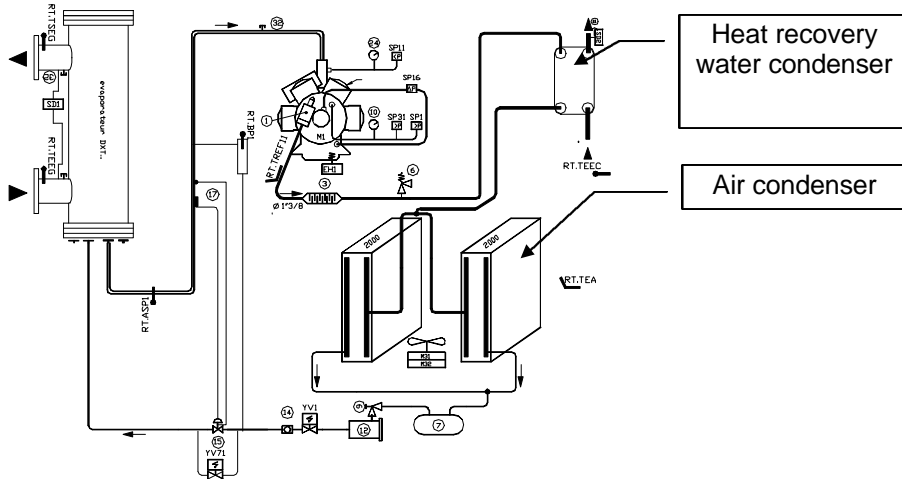

### Determination of heat recovery mode

Unit operation in heat recovery or total discharge mode is defined by the RECUP parameter which is set to 1 or 0. RECUP is determined depending on :

- FSR ⇔ Recovery condenser flow controller
- TSECR ⇔ Hot water output temperature (°C)
- CONSEH ⇔ Hot water instruction (°C)

RECUP is set to 1 if :  
 . FSR is on for over 15 seconds  
 and . TSECR < CONSEH.

RECUP remains at 1 as long as :  
 . FSR has not been off for over 15 seconds  
 and . TSECR < CONSEH+2°C.

### Control of air condenser fans

On switching to recovery mode, the ventilation thermostat for circuit n THVn is forced to 0 for 5 seconds.

If the high pressure of circuit n exceeds 23 bar, THVn is increased by 1 stage. The ventilation thermostat continues to be incremented by 1 every TEMPOV (time interval) as long as the condition on the pressure is satisfied. Every time THVn is incremented, the value of the hot water output temperature TSECR is memorised in the variable MTSECR.

In recovery mode, if TSECR becomes lower than MTSECR whilst at least one fan is in operation, the ventilation thermostat is decremented.

**Note:** On water units, the CLIMATIC does not include heat recovery

# MANAGEMENT OF UNITS IN PARALLEL

## Function

To provide staging of units in order to adjust the temperature of the cooled fluid as closely as possible to the set point.

## Description

### ❶ Management of the installation by an independent CPU card (recommended configuration)

General regulation is by a KP01 independent of those which directly control the units. Dialogue between the cards is by hard contact only, without chaining.

#### ☞ Outline hydraulics diagram (case of chilled water production)

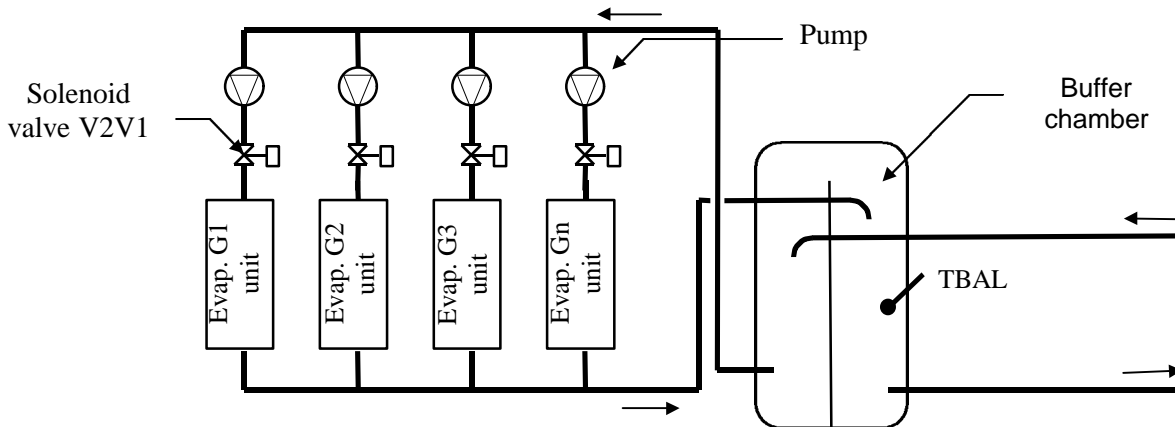

#### ☞ Thermostat on units

The thermostat THERG controls switching on and off of the different installation units  $G_n$ .

THERG is calculated in accordance with the following parameters:

- TBAL ⇔ Water temperature in the chamber (°C)
- CONSEG ⇔ Water instruction for regulation of units (°C)
- ENCLG ⇔ Operating differential for one unit (°C)
- DIFETG ⇔ Differential between units (°C)

Case of an installation with 4 machines :

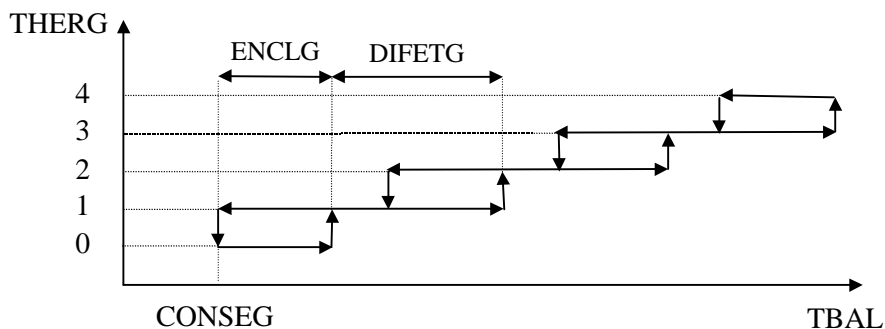

# REGULATION OF UNITS IN PARALLEL

With CONSEG = 6°C  
 ENCLG = 1,5°C  
 DIFETG = 1,5°C

Units start-up		Unit stop	
THERG	TBAL (°C)	THERG	TBAL (°C)
0 ⇨ 1	7,5	1 ⇨ 0	6
1 ⇨ 2	9	2 ⇨ 1	7,5
2 ⇨ 3	10,5	3 ⇨ 2	9
3 ⇨ 4	12	4 ⇨ 3	10,5

**Notes :** THERG can only be incremented by a stage if it has not increased for a time defined using instructions TPHERM.  
 THERG can only be decremented by a stage if it has not decreased for a time defined using instructions TPHERD.

## ☞ Control of isolation valves for evaporators on each unit

If the regulation thermostat THERG requests operation of unit Gn, valve V2Vn is sent a command to open.

## ☞ Operation of units

The start-up of the next priority unit Gn is authorised if the opening command has been issued to valve V2Vn for at least TPV2V (variable time). The hard contact representing this authorisation to switch a unit on (associated variable MAARGn) must be wired to the "remote on / off" input connection for the machine.

Each unit controls its own compressors and pump in accordance with its own set point (see "cold thermostat" chapter page 5). For better general regulation, it is recommended to set unit instructions to the same value as CONSEG.

## ☞ Fault management and automatic unit logging

Each unit sends its availability state to the general regulation card. Depending on the overall availability of all units, an optimal priority order PRIG is defined (units with no faults are put at the top of the priority list) :

PRIG	Ordure of unit start-up
0	G1 / G2 / G3 / G4
1	G4 / G1 / G2 / G3
2	G3 / G4 / G1 / G2
3	G2 / G3 / G4 / G1

In order to level out operating times for the different units, and if they are all available, PRIG changes automatically once a week, on Monday at 6 pm.

If the temperature sensor in the chamber is defective, all the valves are opened and, when the time interval TPV2V is up, start-up authorisation is issued to all the units.

# REGULATION OF UNITS IN PARALLEL

## ② Installation management by chaining of unit CPU's

The card responsible for general regulation is that for unit G1 (card number = 0). Dialogue between cards is by chaining.

In order to ensure that the machines do not all start up and stop simultaneously, their set points are staggered. The regulation instruction CONSREG for each machine is determined in accordance with the following parameters :

- VCONSE ⇔ General regulation instruction (°C)  
VCONSE is the water instruction entered on unit G1. This unit transmits it to the other units.
- PRIG ⇔ Unit start-up priority  
PRIG is processed and transmitted to the other units by the unit G1. PRIG changes automatically every Monday at 6 pm, which levels out operating times between the different units
- DIFETG ⇔ Differentail between units (°C)  
DIFETG is an instruction set on each machine.

In the case of an installation with 4 units, regulation instructions CONSREG are calculated as follows :

Setting instruction CONSREG				
PRIG	Unit G1	Unit G2	Unit G3	Unit G4
0	VCONSE	VCONSE+DIFETG	VCONSE+(2xDIFETG)	VCONSE+(3xDIFETG)
1	VCONSE+DIFETG	VCONSE+(2xDIFETG)	VCONSE+(3xDIFETG)	VCONSE
2	VCONSE+(2xDIFETG)	VCONSE+(3xDIFETG)	VCONSE	VCONSE+DIFETG
3	VCONSE+(3xDIFETG)	VCONSE	VCONSE+DIFETG	VCONSE+(2xDIFETG)

In the event of a breakdown, there is no logging between units. If a machine loses its connection with unit G1, it regulates its instructions independently of the other units. If card no.0 of machine G1 is absent from the chaining, then all units are regulated independently according to their own instructions.

# MACHINE FAULTS

## CONTENTS

	Page
TEMPERATURES OF CHILLED WATER OUTSIDE RANGE.....	23
HOT WATER TEMPERATURES OUTSIDE RANGE .....	24
INSUFFICIENT FLOW OF CHILLED WATER .....	25
INSUFFICIENT FLOW OF HOT WATER.....	26
ABSENCE OF 230V SUPPLY WITH BACKUP.....	27
INCORRECT SEQUENCE OF PHASES .....	28

# TEMPERATURES OF CHILLED WATER OUTSIDE RANGE

Logical variable : **DTEG**

Incident codes KP02 : **1**

KP07 icon :



## Description

The input or output chilled water temperature measured by the sensor is outside the authorised range:

Water without glycol  
 TEEG < TEGI ou TEEG > 65°C  
 TSEG < TEGI ou TSEG > 65°C

Water with glycol (maxi 30% glycol)  
 TEEG < -15°C ou TEEG > 65°C  
 TSEG < -15°C ou TSEG > 65°C

With :

TEEG ⇔ Chilled water input temperature (°C)  
 TSEG ⇔ Chilled water output temperature (°C)  
 TEGI ⇔ Minimum chilled water temperature for evaporator (°C)

## Action

- ☞ Immediate machine halt.
- ☞ The fault is displayed on the screen.
- ☞ The remote fault report is delayed for 6 minutes.

## Resetting

**Automatic** fault resetting once chilled water temperatures return to normal operating range :

Water without glycol  
 TEGI+2°C < TEEG < 60°C  
 TEGI+2°C < TSEG < 60°C

Water with glycol (maxi 30% glycol)  
 -10°C < TEEG < 60°C  
 -10°C < TSEG < 60°C

## Trouble-shooting

Sensor fault on input or output of chilled water.  
 Wiring fault or disconnection of sensor.

## Solution

Replace sensor.  
 Check sensor connection.



# HOT WATER TEMPERATURES OUTSIDE RANGE

Logical variable : **DTEC**

Incident codes KP02 : **2**

KP07 icon : 

## Description

The input or output temperature of hot water measured by the sensor is outside the authorised range :

TEEC <-27°C or TEEC> TECS  
TSEC <-27°C or TSEC> TECS

With :

TEEC ⇔ Hot water input temperature (°C)  
TSEC ⇔ Hot water output temperature (°C)  
TECS ⇔ Maximum hot water temperature at condenser (°C)

## Action

- ☞ Immediate machine halt.
- ☞ The fault is displayed on the screen.
- ☞ The remote fault report is delayed for 6 minutes.

## Resetting

**Automatic** fault resetting once hot water temperatures return to normal operating range :

TEEC > -27°C and TEEC < TECS-5°C  
TSEC > -27°C and TSEC < TECS-5°C

## Trouble-shooting

Sensor fault on hot water.  
Wiring fault or disconnection of the sensor.

## Solution

Replace the sensor.  
Check sensor connection.

# INSUFFICIENT FLOW OF CHILLED WATER

Logical variable : **DFSE**

Incident codes KP02 : **3**

KP07 icon :



## Description

The "flow switch" FSE detects an insufficient flow in the evaporator for over 2 seconds.

## Action

- ☞ Immediate machine halt.
- ☞ The fault is displayed on the screen.
- ☞ The remote fault report is delayed for 6 minutes

## Resetting

The machine restarts **automatically** 20 seconds after the flow of chilled water is restored.

## Trouble-shooting

Wiring fault on pump control.  
 Wiring fault on flow controller.  
 Water filter clogged.  
 Setting fault on flow controller.

## Solution

Check pump connection.  
 Check flow controller connection.  
 Clean water filter.  
 Adjust flow controller.

# INSUFFICIENT FLOW OF HOT WATER

Logical variable : **DFSEC**

Incident codes KP02 : **4**

KP07 icon : 

## Description

The "flow switch" FSC detects insufficient flow insufficient in the condenser for over 3 seconds

## Action

- ☞ Immediate machine halt.
- ☞ The fault is displayed on the screen.
- ☞ The remote fault report is delayed for 6 minutes.

## Resetting

The machine restarts **automatically** 20 seconds after the flow of hot water is restored.

## Trouble-shooting

Wiring fault on control pump.  
Wiring fault on flow controller.  
Water filter clogged.  
Setting fault on flow controller.

## Solution

Check pump connection.  
Check flow controller connection.  
Clean water filter.  
Adjust flow controller.

# ABSENCE OF 230V SUPPLY WITH BACKUP

Logical variable : **DPT230V**

Incident codes KP02 : **7**

KP07 icon :



## Description

The supply presence voltage relay is tripped (PT230V = 0).  
The compressor casing resistors and the anti-freeze resistors on the hydraulic circuit are no longer fed.

## Action

- ☞ Immediate machine halt.
- ☞ The fault is displayed on the screen.
- ☞ The remote fault report is delayed for 6 minutes.

## Resetting

The machine restarts **automatically** 20 seconds after the 230 V supply has been restored.

## Trouble-shooting

Wiring fault on 230 V supply.  
Wiring fault on voltage presence relay.

## Solution

Vérifier les connexions et la tension de l'alimentation 230 V qui arrive sur la machine.  
Vérifier le câblage du relais de présence tension.

# INCORRECT SEQUENCE OF PHASES

Logical variable : **DPHASE**

Incident codes KP02 : **9**

KP07 icon :



## Description

The phase controller is tripped (PHASE = 0).  
It detects an inversion or a bad phase coupling.

## Action

- ☞ Immediate machine halt.
- ☞ The fault is displayed on the screen.
- ☞ The remote fault report is delayed for 6 minutes.

## Resetting

The machine can only be restarted after **manual** resetting and the correct re-establishment of phases.

## Trouble-shooting

Fault appears the first time the machine is switched on.  
Absence of a supply phase.

Wiring fault on phase presence contact.

## Solution

Reverse two of the three phases upstream of the unit.  
Check the presence of the three phases and voltage values between phases.  
Check wiring on phase presence contact.

# CIRCUITS FAULTS

## CONTENTS

	Page
LOW PRESSURE INSUFFICIENT.....	30
EVAPORATOR FREEZING .....	31
INSUFFICIENT SUPERHEATING .....	32
VACUUM SUCCION FAILURE .....	33
SENSOR OR DETECTOR FAULTS .....	34
EXPANSION VALVE OPENING INCORRECT .....	35

# LOW PRESSURE INSUFFICIENT

Logical variable : **DBPn**

Incident codes KP02 : **n1**

KP07 icon :



## Description

**Case ①** : No compressor on circuit n is working. The liquid valve has been open for 2 minutes, but low pressure remains lower than safety limits.

**Case ②** : A compressor on circuit n has been operating for more than 2 minutes. The liquid valve is open and the expansion valve bypass valve (if applicable) has been closed for 1 minute, but low pressure is insufficient.

**Reminder**: The units with an expansion valve bypass valve are those fitted with the "all seasons" option and thermostatic expansion valves.

**Case ③** : A compressor on circuit n has been operating for over 6 minutes, all other compressors in service on the circuit have been operating for at least 2 minutes and insufficient low pressure is detected

## Action

- ☞ If circuit n is not in operation, start-up has not been authorised. If it is in operation, it stops immediately.
- ☞ The fault is displayed on the screen.
- ☞ The remote fault report is delayed for 6 minutes.

## Resetting

**Case ① & ②** : **Three automatic fault resets are allowed daily. After this, circuit n can only be restarted after manual resetting.**

**Case ③** : Resetting is *manual*.

**Note** : "Low pressure" failure counters TOBPn are all *reset to zero daily at 6 pm*, on condition that the maximum number of faults authorised has not been reached.

## Trouble-shooting

Insufficient circuit load.  
Malfunction of the liquid solenoid valve.  
Malfunction of expansion valve.  
Dehydrator clogged.



## Solution

Complete the load.  
Check solenoid valve operation.  
Check expansion valve operation.  
Change dehydrator.

# EVAPORATOR FREEZING

Logical variable : **DGELn**

Incident codes KP02 : **n2**

KP07 icon :  

## Description

**This fault is only processed on machines cooling water without solution which does not freeze at 0°C (glycol or brine)**

### Case ① : Tubular exchangers

A compressor m on circuit n has been operating for at least 1 minute and the following 2 conditions remain satisfied for over 2 minutes:  
 TBPn < TBPI and TASPn < +5°C

### Case ② : Plate exchangers

A compressor m on circuit n has been operating for at least 2 minutes and :  
 TBPn < TBPI for over  
     . **5 seconds** for R407C units  
     . **30 seconds** for R22 units.

With : TBPn ⇔ Evaporation temperature circuit n (°C)  
 TBPI ⇔ Minimum evaporation temperature (°C)

The minimum (and default) value of instruction TBPI is defined as follows :

- . Tubular evaporators ⇔ -4°C
- . R407C plate evaporators ⇔ +1°C (stream saturation)
- . R22 plate evaporators ⇔ -1,7°C

TASPn ⇔ Suction temperature for circuit n (°C)

## Action

- ☞ Immediate halt of circuit n.
- ☞ The fault is displayed on the screen.
- ☞ The remote fault report is delayed for 6 minutes.

## Resetting

Cas ① : For the first fault, resetting is **automatic** after of **30 minutes**, if the evaporation temperature has returned to over +1°C.  
 After this, circuit n can only be restarted after **manual** resetting

Cas ② : For the first fault, the resetting is **automatic** after **30 minutes**, if the evaporation temperature has returned to over TBPI+3°C.  
 After this, circuit n can only be restarted after **manual** resetting.

**Note** : "Freeze" failure counters TOGELn are all reset to **zero daily at 6 pm**, on condition that the maximum number of authorised faults has not been reached.

## Trouble-shooting

Incorrect TBPI instruction settings.  
 Evaporation, suction or chilled water output sensor fault.  
 Wiring fault or disconnection of the sensor.  
 Water flow in the evaporator insufficient.

## Solution

Check instruction settings.  
 Replace the sensor.  
 Check sensor connection.  
 Check flow and setting of flow controller.



# INSUFFICIENT SUPERHEATING

Logical variable : **DSURFn**

Incident codes KP02 : **n4**

KP07 icon :



## Description

**This fault is only processed on units fitted with electrical expansion valves.**

A compressor on circuit n has been operating for at least 2 minutes and one of the 2 following conditions remains satisfied for at least 2 *minutes* :

$$\begin{aligned} \text{TASPn} &\geq (\text{TEEG} + 3^\circ\text{C}) \\ (\text{TASPn} - \text{TBPn}) &\leq 2^\circ\text{C} \end{aligned}$$

With :

TASPn ⇔ Suction temperature on circuit n (°C)  
 TBPn ⇔ Evaporation temperature on circuit n (°C)  
 TEEG ⇔ Chilled water intake temperature (°C)

## Action

- ☞ Immediate halt of circuit n.
- ☞ The fault is displayed on the screen.
- ☞ The remote fault report is delayed for 6 minutes.

## Resetting

Fault resetting is **manual**.

## Trouble-shooting

Evaporation, suction or chilled water intake sensor fault.  
 Wiring fault or disconnection of one of these sensors.

## Solution

Replace the sensor.  
 Check sensor connections.

# VACUUM SUCTION FAILURE

Logical variable : **DPUMPDn**

Incident codes KP02 : **n5**

KP07 icon :



## Description

For **2 minutes**, a compressor on circuit n is in operation and the liquid solenoid is not connected, but low pressure is still below minimum.

## Action

- ☞ Immediate halt of circuit n.
- ☞ The fault is displayed on the screen.
- ☞ The remote fault report is delayed for 6 minutes.

## Resetting

The first 2 faults are **automatically** reset after **2 minutes**.

After this, circuit n can only be restarted after a **manual** reset.

**Note** : Counters of “pump down” failures TOPUMPDn are all *reset to zero daily at 6 pm*, on condition that the maximum number of authorised faults has not been reached.

## Trouble-shooting

Liquid solenoid blocked open by foreign matter.

## Solution

Change the solenoid valve.

# SENSOR OR DETECTOR FAULTS

Logical variable : **DSONDEn**

Incident codes KP02 : **n6**

KP07 icon :



## Description

One or more temperature sensors or pressure detectors installed on circuit n are either in short-circuit, broken or disconnected.

### Sensor or detector involved

Suction temperature sensor  
 Internal sensor on electronic expansion  
 Low pressure detector  
 High pressure detector

### Condition for occurrence of fault

$TASPn \leq -40^{\circ}\text{C}$   
 $1000 \text{ U} \leq RDETn \leq 50 \text{ U}$   
 $BPn \leq 0,5 \text{ bars}$   
 $HPn \leq 0,5 \text{ bars}$

**Note :** All these sensors and detectors are not necessarily present on the same machine.

## Action

- ☞ Immediate halt of circuit n.
- ☞ The fault is displayed on the screen.
- ☞ The remote fault report is delayed for 6 minutes.

## Resetting

Circuit n can only be restarted after **manual** resetting and correct reading of all detectors and sensors.

## Trouble-shooting

Sensor or detector fault.  
 Wiring fault or disconnection of a sensor or detector.

## Solution

Replace the element.  
 Check sensor and detector connections

# EXPANSION VALVE OPENING INCORRECT

Logical variable : **DCDEtn**

Incident codes KP02 : **n7**

KP07 icon : 

## Description

This fault is only processed on units equipped with electric expansion valves DANFOSS TQ type.

No compressor on circuit n is working. A compressor start-up command has been issued and the expansion valve is in the pre-heat phase.

After **6 minutes**, the expansion valve opening value calculated for start-up of the compressor has still not been reached.

## Action

- ☞ Circuit n start-up is not authorised.
- ☞ The fault is displayed on the screen.
- ☞ The remote fault report is delayed for 6 minutes.

## Resetting

Fault resetting is **manual**.

## Trouble-shooting

Expansion valve sensor fault.  
Wiring fault or disconnection of the sensor.  
24V supply fault on expansion valve.  
The green LED on the static relay is lit up but the expansion valve is not heating.

## Solution

Replace expansion valve.  
Check sensor connection.  
Check supply  
Check the static relay and the expansion valve controller card.

# COMPRESSOR FAULTS

## CONTENTS

	Page
COMPRESSOR CUT-OUT SWITCH TRIPPED.....	37
OIL PRESSURE INSUFFICIENT .....	38
EXCESS HIGH PRESSURE.....	39
DISCHARGE TEMPERATURE TOO HIGH .....	40
INTERNAL PROTECTION TRIPPED .....	41

# COMPRESSOR CUT-OUT SWITCH TRIPPED

Logical variable : **DELECMn**

Incident codes KP02 : **mn1**

KP07 icon : 

## Description

The thermomagnetic cut-out switch on compressor mn is tripped (ELECmn = 0).

## Action

- ☞ Immediate halt of compressor mn.
- ☞ The fault is displayed on the screen.
- ☞ The remote fault report is delayed for 6 minutes.

## Resetting

Compressor mn can only be restarted after engagement of the cut-out switch and a **manual** reset.

## Trouble-shooting

Faulty connection or connections too tight.  
Cut-out switch wrongly set.

## Solution

Check connections.  
Set the protection in accordance with the rated current for the compressor.

# OIL PRESSURE INSUFFICIENT

Logical variable :  
**DHUILEmn**

Incident codes KP02 : **mn2**

KP07 icon : 

## Description

**This fault only applies to semi-hermetic reciprocating compressors.**

The total time during which the oil pressostat on compressor mn POILmn remains tripped exceeds *90 seconds*. The oil pressure is then insufficient for proper lubrication of the compressor.

**Note** : The counter for periods of low oil pressure is reset to zero if the oil pressostat remains above its triggering point for over 3 minutes.

## Action

- ☞ Immediate halt of compressor mn.
- ☞ The fault is displayed on the screen.
- ☞ The remote fault report is delayed for 6 minutes.

## Resetting

The first fault is reset **automatically**.

After this, compressor mn can only be restarted after a **manual** reset

**Note** : Counters for "oil pressure" failures TOOILmn are all **reset to zero daily at 6 pm**, on condition that the maximum number of authorised faults has not been reached.

## Trouble-shooting

Lack of oil in the compressor.  
Oil pump fault.  
Oil pressostat wrongly set.  
Wiring fault on oil pressostat.

## Solution

Check oil level.  
Change oil pump.  
Check setting of oil pressostat.  
Check wiring on oil pressostat.

# EXCESS HIGH TEMPERATURE

Logical variable : **DHPmn**

Incident codes KP02 : **mn5**

KP07 icon :



## Description

The high pressure safety cut-out on compressor mn PHPmn has tripped..

## Action

- ☞ Immediate halt of compressor mn.
- ☞ The fault is displayed on the screen.
- ☞ The remote fault report is delayed for 6 minutes.

## Resetting

The first 2 faults are reset **automatically**

After this , the compressor mn can only be started after a **manual** reset.

**Note** : Counters for " high pressure" failures TOHPmn are all **reset to zero daily at 6 pm**, on condition that the maximum number of authorised faults has not been reached.

## Trouble-shooting

Condenser clogged.  
 Fault on parameter settings for regulation of condensation.  
 Malfunction of liquid solenoid valve.  
 Dehydrator clogged.  
 Wiring fault or high pressure safety cut-out wrongly set

## Solution

Clean condenser  
 Check parameter settings  
  
 Check operation of solenoid valve.  
 Replace the dehydrator  
 Check setting and wiring of high pressure safety cut-out.



# DISCHARGE TEMPERATURE TOO HIGH

Logical variable : **DREFmn**

Incident codes KP02 : **mn6**

KP07 icon :



## Description

The discharge temperature on compressor mn REFmn stays over **120°C** for over **9 seconds**.

## Action

- ☞ Immediate halt of compressor mn.
- ☞ The fault is displayed on the screen.
- ☞ The remote fault report is delayed for 6 minutes

## Resetting

The first 2 faults are reset **automatically** after a delay of **30 minutes** on condition that REFmn has dropped below the maximum.

After this, compressor mn can only be restarted by **manual** resetting (this reset can only be processed **30 minutes** after generation of the fault).

**Note** : Counters for “discharge too high” failures TOREFmn **are all reset to zero daily at 6 pm**, on condition that the maximum number of authorised faults has not been reached.

## Trouble-shooting

Discharge sensor fault.  
Wiring fault on the sensor.  
Insufficient refrigerant in circuit.  
Superheat setting too high.

## Solution

Replace sensor.  
Check sensor connection.  
Check refrigerant.  
Check superheat setting.

# INTERNAL PROTECTION TRIPPED

Logical variable : **DPINTmn**

Incident codes KP02 : **mn7**

KP07 icon : 

## Description

- ☞ Semi-hermetic compressors (reciprocating and screw type) and scroll compressors:  
The thermal protection on the motor windings on mn PINTmn is tripped.
- ☞ Hermetic reciprocating compressors:  
Compressor mn has been operating for 6 minutes and the discharge temperature REFmn is less than  $\theta$ .  
This shows that the internal protection on the compressor has been tripped.

	$\theta$ (°C)
R22 & R407C	40
R134a & R404A	30

## Action

- ☞ Immediate halt of compressor mn.
- ☞ The fault is displayed on the screen.
- ☞ The remote fault report is delayed for 6 minutes.

**Note** : switched off, the fault is not memorised.

## Resetting

Compressor mn can only be restarted after re-closing the internal protection and a **manual** reset.

## Trouble-shooting

Fault on supply to internal protective relay.  
Discharge sensor badly wired or defective (possible with hermetic reciprocating compressors).  
Superheat setting too high.

## Solution

Check supply to relay.  
Check sensor connection and replace if necessary.  
  
Check superheat setting.

# MISCELLANEOUS FAULTS

## CONTENTS

	Page
INTER CPU DIALOGUE INTERRUPTED.....	43
INSUFFICIENT FLOW ESTABLISHED BY THE PUMP.....	44
FANS CIRCUIT BREAKERS TRIPPED.....	45
PUMP CIRCUIT BREAKER TRIPPED.....	46
REMOTE INSTRUCTION UNDETECTED.....	47
TEMPERATURE OF FREE-COOLING OUTSIDE RANGE.....	48
DIALOGUE BETWEEN CPU AND KP07 INTERRUPTED.....	49

# INTER-CPU DIALOGUE INTERRUPTED

Logical variable : **DSL**

Incident codes KP02 : **8**

KP07 icon :



## Description

The chaining link between 2 (or more) cards on the network is interrupted for over **15 seconds**..

## Action

- ☞ Re-initialisation of cards (**3 attempts**).
- ☞ The fault is displayed on the screen.

## Resetting

**Automatic** resetting of the fault 3 minutes after the link between all cards is restored.

## Trouble-shooting

Wiring fault on link between CPU's.  
Power failure on one of the cards.  
Faulty positioning of SW2 and SW3 jumpers

## Solution

Check connection on link between CPU's.  
Check electrical supply to cards.  
Check the position of jumpers.

# INSUFFICIENT FLOW ESTABLISHED BY THE PUMP

Logical variable : **DSDEBk**

Incident codes KP **81** (pump 1)  
**82** (pump 2)

KP07 icon : 

## Description

Pump k supplying the evaporator has had the operational command for **20 seconds**.  
The "flow switch" FSE detects insufficient flow in the exchanger for over **25 seconds**.

## Action

**Case ❶** : The unit has **one pump only, or no pump** (C2POMPE = 0).

- ☞ Immediate halt of pump k.
- ☞ The fault is displayed on the screen.
- ☞ The remote fault report is delayed for 6 minutes.
- ☞ 22 seconds before generation of the fault, the machine has been stopped with the fault "insufficient flow of chilled water" (see page 23).

**Case ❷** : The unit has two pumps (C2POMPE = 1).

- ☞ Immediate halt of pump k.
- ☞ Start-up of the 2nd pump (see chapter "control of evaporator pumps" page 4).
- ☞ The fault is displayed on the screen.
- ☞ The remote fault report is delayed for 6 minutes.

## Resetting

**Case ❶** : The unit has **no pump** (C2POMPE=0 and the flow-switch is closed without POMPEk having the operational command).  
The machine restarts **automatically** 20 seconds after the flow is restored.

**Case ❷** : The unit has **one pump** (C2POMPE=0).  
The machine can only be restarted after a **manual reset**

**Case ❸** : The unit has **two pumps** (C2POMPE=1).  
If the flow is restored within 20 seconds following the start-up command issued to the 2nd pump, the machine restarts **automatically**. Otherwise, the unit can only be restarted after a **manual** reset.

## Trouble-shooting

Wiring fault on the control pump.  
Wiring fault on the flow controller.  
Water filter clogged.  
Flow controller wrongly set.

## Solution

Check the pump connection.  
Check the connection on the flow controller.  
Clean the water filter.  
Adjust the flow controller setting.

# FAN CIRCUIT BREAKERS TRIPPED

Logical variable : **DELECV**

Incident codes KP02 : **90**

KP07 icon :



## Description

One or more thermomagnetic circuit breakers protecting the air condenser fans are tripped. (ELECV = 0).

## Action

- ☞ The fault is displayed on the screen.
- ☞ The remote fault report is delayed for 6 minutes.

## Resetting

The fault is reset **automatically** once all the fan circuit breakers are reset.

## Trouble-shooting

Bad connection or connections too tight.  
Circuit breakers wrongly set.

## Solution

Check connections.  
Set protections according to the rated current for fans.

# PUMP CIRCUIT BREAKER TRIPPED

Logical variable : **DELECPk**

Incident codes KP<sup>91</sup> (pompe 1)  
KP<sup>92</sup> (pompe 2)

KP07 icon : 

## Description

The thermomagnetic circuit breaker on pump k is tripped (ELECPk = 0).

## Action

**Case ①** : Pump k is in service and the unit has **only one pump** (C2POMPE = 0).

- ☞ Immediate halt of pump k
- ☞ Immediate machine halt
- ☞ The fault is displayed on the screen.
- ☞ The remote fault report is delayed for 6 minutes.

**Case ②** : Pump k is in service and the unit has **two pumps** (C2POMPE = 1).

- ☞ Immediate halt of pump k.
- ☞ Start-up of the 2nd pump (see chapter "control of evaporator pumps" page 4).
- ☞ The fault is displayed on the screen.
- ☞ The remote fault report is delayed for 6 minutes.

**Case ③** : Pump k is not in service.

- ☞ The fault is displayed on the screen.
- ☞ The remote fault report is delayed for 6 minutes.

## Resetting

**Case ①** : The machine restarts automatically **20 seconds** after the fault has been cleared and the CLIMATIC has restarted the pump

**Case ②** : The fault is reset **automatically** once the pump circuit breaker is reset

**Case ③** : The fault is reset automatically once the pump circuit breaker is reset.

## Trouble-shooting

Bad connection or connections too tight.  
Circuit breaker wrongly set.

## Solution

Check connections.  
Set the protection in accordance with the rated current for the pump.

# REMOTE INSTRUCTION UNDETECTED

Logical variable : **DCONS**

Incident codes KP02 : **95**

KP07 icon :



## Description

The unit should be regulated to the water instruction sent remotely by the customer (SGLCONS = 1), but the signal received is incorrect (TCONS < -25°C).

## Action

- ☞ The machine is not stopped and is regulated to its own water instruction.
- ☞ The fault is displayed on the screen.
- ☞ The remote fault report is delayed for 6 minutes.

## Resetting

Once TCONS > -25°C, the fault is reset **automatically**.

The machine can once again be regulated to the remote instruction.

## Trouble-shooting

Wiring fault on 4/20mA signal.

## Solution

Check wiring (see wiring diagram).



# TEMPERATURE OF FREE-COOLING OUTSIDE RANGE

Logical variable :  
**DSONDEFc**

Incident codes KP02 : **97**

KP07 icon : 

## Description

The inlet chilled water temperature, which is measured by the sensor located on the collector (forward free-cooling coils), is outside authorized range :

$TEEGFC < -15^{\circ}\text{C}$  ou  $TEEGFC > 65^{\circ}\text{C}$

## Action

- ☞ Immediate halt of free-cooling (free-cooling fans stop and the 3 way valve completely by-pass the coils)
- ☞ The fault is displayed on the screen.
- ☞ The remote fault report is delayed for 6 minutes.

## Resetting

**Automatic** fault resetting, as soon as inlet chilled water temperature is inside the normal operation conditions.

$-10^{\circ}\text{C} < TEEGFC < 60^{\circ}\text{C}$

## Trouble-shooting

Sensor fault on free-cooling water inlet.  
Wiring fault or disconnection of sensor.

## Solution

Replace sensor.  
Check sensor connection.

# DIALOGUE BETWEEN CPU AND KP07 INTERRUPTED

Logical variable : -

Incident codes KP02 : -

KP07 icon :



## Description

After 3 attempts, the KP07 VDU has not succeeded in establishing a dialogue with at least one of the CPU cards connected to it.

## Action

- ☞ Regular attempts to restore communication.
- ☞ The fault is displayed on the screen.
- ☞ The remote fault report is delayed for 6 minutes.

## Resetting

The fault is reset **automatically** once dialogue is restored.

## Trouble-shooting

Wiring fault on link between the KP07 and the CPU.  
Power failure on one of the cards.

## Solution

Check the connection of the link between the cards.  
Check electrical supply to cards.

# KP02 DIGITAL CONSOLE

## I. GENERAL PRESENTATION

The KP02 console is a man-machine interface consisting of a 6 digit display, 6 indicator lights and 5 keys.

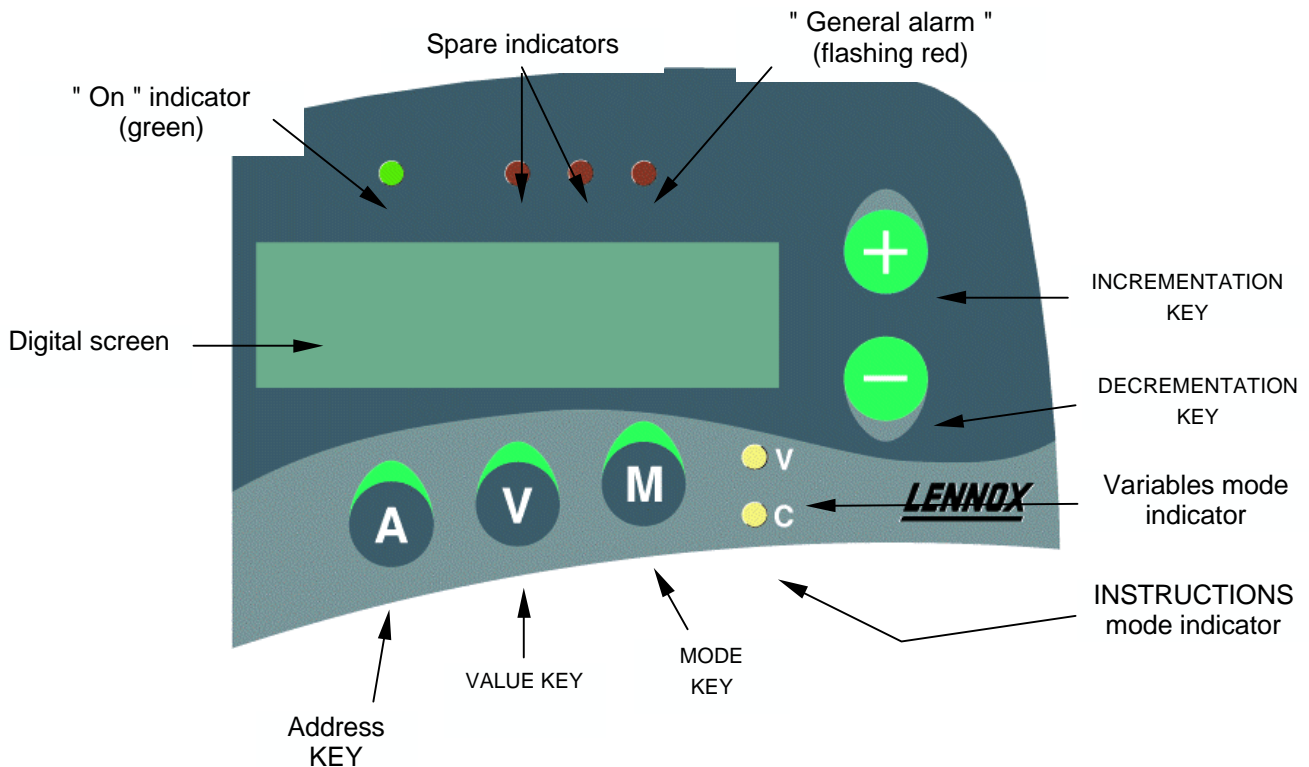

This console is principally used to read and/or modify the values of variables or instructions for the CPU card to which it is connected.

Dialogue with the CPU is initiated by the KP02. If, after 3 attempts, communication is not established, a message indicating the communication problem is displayed (see §II.5.c). The console will then make regular attempts to reconnect.

Data transmission speed is 1200 baud, in 8-bit format (1 start, 8 bits, odd parity, 1 stop).

## II. DISPLAY FORMATS

### II.1. Time

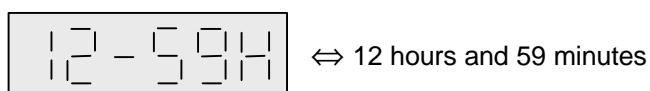

When the console keypad is inactive for 5 minutes, the time is automatically displayed.

# CONSOLE NUMERIQUE KP02

## II.2. Date

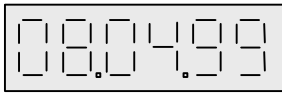

## II.3. Address of a variable

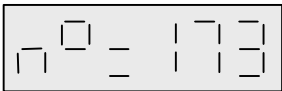

## II.4. Value of a variable

### II.4.a. Logical values

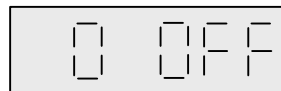
 (1  $\Leftrightarrow$  ON) (0  $\Leftrightarrow$  OFF)

### II.4.b. Températures

The temperatures are displayed in °C, to nearest 0.1°C.

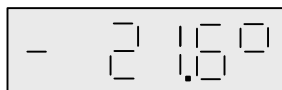
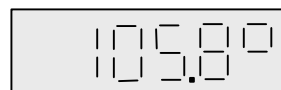
  $\Leftrightarrow$  -21.6°C  $\Leftrightarrow$  +105.8°C

### II.4.c. Pressures

The pressures are shown in bar, to nearest 0.1 bar.

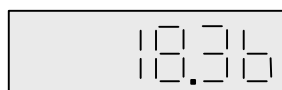
  $\Leftrightarrow$  18.3 bars

### II.4.d. Other analogue values

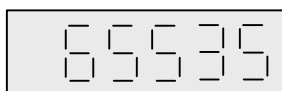
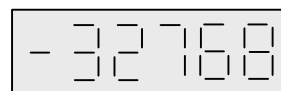
 Values without signs Signed values

### II.4.e. Fault mode

  $\Leftrightarrow$  Discharge temperature too high on compressor 1 on circuit 2.

# KP02 DIGITAL CONSOLE

When a fault occurs on the machine, the red led "general alarm" flashes. If the user wishes to know the nature of the fault, he can consult the variable "breakdown" representative of the code "breakdown".

## II.5. Specific displays

### II.5.a. Application release

When the console is switched on, the computer application release number is displayed.

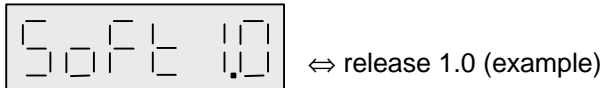

### II.5.b. Test de l'afficheur

Correct operation of the VDU can only be tested at the time the console is switched on, by pressing on the 3 keys "A", "M" and "-" simultaneously. Correct operation of the VDU is shown as follows:

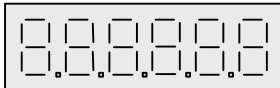

### II.5.c. KP02 / CPU communication fault

An absence of dialogue between the KP02 console and the CPU card is signalled by the permanent following message:

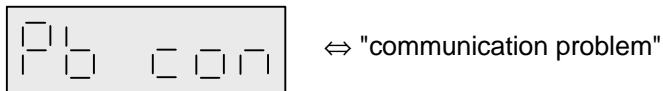

## III. OPERATING MODES

4 modes are available:

1. VARIABLES mode is used to read the values of variables.
2. INSTRUCTIONS mode is used to modify setting instructions.
3. READ DATER mode is used to read the time and date.
4. SET DATER mode is used modify the time and date.

The user selects the required mode by pressing the "M" key as many times as necessary.

Mode	Indicator "V"	Indicator "C"
VARIABLES	On	off
INSTRUCTIONS	Off	On
READ DATER	Off	Off
SET DATER	On	on

# KP02 DIGITAL CONSOLE

## III.1. VARIABLES mode

Pressing on "A" displays the address of the variable currently being read.

The address is incremented by pressing keys "A" and "+" simultaneously. The address is incremented slowly if "+" is pressed briefly, or faster if it is pressed continuously.

The address is decremented in a similar manner, using keys "A" and "-".

When the required address is selected, pressing key "V" displays the value of the corresponding variable. Variables are updated cyclically every n seconds.

**Note:** When an address is selected, if the user does not enter a value request, this takes place automatically after 1 minute.

## III.2. INSTRUCTIONS mode

The address of the instruction to be modified is selected as for VARIABLES mode (see § III.1.).

The value of the instruction is increased by pressing keys "V" and "+" simultaneously. The value increases slowly if "+" is pressed briefly, and faster if it is pressed continuously. Slow incrementation is by 0.1 for temperatures and pressures and 1 for other values. Fast incrementation starts with the rightmost digit then moves to the left.

Decrementation is in a similar manner, using keys "A" and "-".

As soon as key "V" is released, the value displayed is sent to the CPU.

Access to instructions other than CONSEA, CONSEB, DELTAT, MAARCn and RESET is restricted. For access to all instructions, a password must be entered in the reserved instruction at address no.0. If the password is correct, the following message is displayed when key "V" is released:



After 5 minutes of keypad inactivity, the console automatically cancels unlimited access to instructions. To modify a protected instruction the password must be re-entered.

## III.3. READ DATER mode

Read accessible dater elements are :

. Time

↔

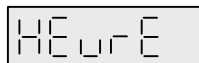

. and date

↔

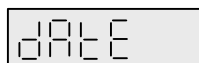

The element is selected by holding key " A " pressed down and pressing briefly on " + " or " - " .

# CONSOLE NUMERIQUE KP02

Pressing key "V" displays the value of the selected data item.

**Note:** If the user does not press "V", the value appears automatically after 1 minute.

## III.4. SET DATER mode

This mode can be used to adjust the 6 dater elements :

. hours and minutes	↔	HEurE
. the day of the month	↔	Jour
. the day of the week	↔	Jour 5
. the month	↔	MOIS
. the year	↔	AnnEE

The element to be modified is selected as for READ DATER mode.

In the same way as for instructions, incrementation of the value is by simultaneously pressing keys "V" and "+" and decrementation by simultaneously pressing "V" and "-".

For the different types of data, setting ranges are as follows :

Item	Minimum value	Maximum value
Hours and minutes	00-00H	23-59H
Day of the month	1	31
Day of the week	1	7
Month	1	12
Year	0	99

Pressing key "A" saves the value entered.

**Note:** Months with less than 31 days are not automatically checked on entry. If a day is entered which is not compatible with the current month, the value is refused at dater level and the old day is retained.  
Examples:

	Day of the month		
	Current value	Value entered	Final value
02 (February)	15	30	15
10 (September)	26	31	31

# KP07 VDU (VISUAL DISPLAY UNIT) CONSOLE

## IV. GENERAL PRESENTATION

The KP07 console is a man-machine interface with a black and white liquid crystal graphics screen, back-lit, with definition 240 x 128 pixels. It also has 2 indicator lights and 12 keys.

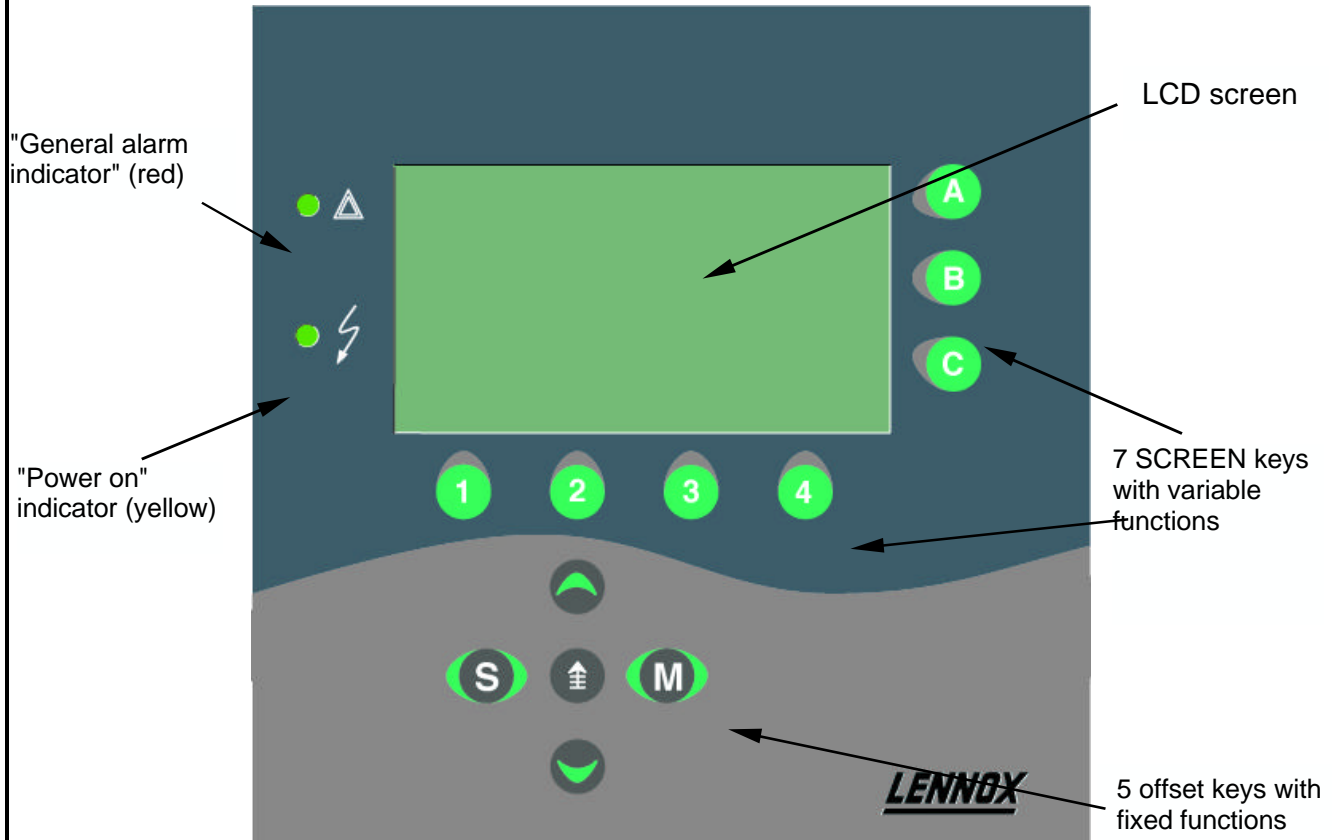

The principal functions of the console are :

- Management of the tree structure of interactive screens.
- Permanent updating of all dynamic parameters displayed on the different screens.
- Saving successive states of predefined variables to be used for analogue and event logs.

A KP07 console can be connected to a maximum of 8 distinct controllers, on condition that they all have the same structure of variables. The number of controllers connected is declared in the application program for the VDU. If a single CPU is connected, its card number is also declared.

The controller / VDU link is serial type and uses JBUS protocol. On connection, the console tries to establish a dialogue with the declared controllers. If, after 3 attempts, the console cannot communicate with a controller, the latter is set to "disconnected" status. The link problem is then displayed on the screen (if the disconnected controller is selected for operator dialogue) and saved in the event log. The KP07 then makes regular attempts to reconnect.

Communication speed is 4800 baud. Data is transferred in 8-bit format (1 start, 8 bits, odd parity, 1 stop).



# KP07 VDU (VISUAL DISPLAY UNIT) CONSOLE

## I.1. Key allocation

### I.1.a. SCREEN keys

These are the 7 keys located around the LCD screen :







The function of these keys may vary from one screen to another, and is defined on the active screen by an icon. For keys "1", "2", "3" and "4", the icon is displayed above the key. For the other 3 keys "A", "B" and "C", the icon is displayed to their left.

Each key offers the possibility:

- of accessing another screen.
- or entering a Boolean value in a given variable.









### I.1.b. Offset keys

The functions of these 5 keys are fixed.

	PAGE DOWN key :	Go to the next page of the same type of screen.
	PAGE UP key :	Go back to the previous page of the same type of screen.
	SUMMARY key :	Go back to the first screen in the tree structure (e-to-d summary)
	LAST SCREEN key :	Return to the last screen selected.
	MODIFICATION key :	Pressing this key activates " modification " mode (see § 1.2.)

## I.2. "Modification" mode

This mode is used to modify the values of all modifiable variables displayed on the active screen. This mode uses the 4 keys "1", "2", "3" and "4", assigning them pre-defined functions :

Key	Associated icon	Key function
		Selection of the variable to be modified.
		Selection of the number to be modified. (Press the key successively to move the cursor, digit by digit, from the right to the left, then the cursor is repositioned on the last digit of the value to be changed.)
		Incrementation of the digit from 0 to 9.
		Confirmation of the current modification.

# KP07 VDU CONSOLE

"Modification" mode offers the user the following main possibilities :

- Selecting the number of the controller on which variables are to be displayed (where several KP01 cards are connected to the same KP07 console)
- Setting instructions
- Configuration of on/off switches on circuits.

To exit from "modification" mode and return to the active screen, press MODIFICATION key.

Notes : - During the modification phase, the screen is no longer updated.  
- If a modification is not confirmed, the variable remains at its previous value.

## **I.3. Contrast adjustment**

Contrast on the display unit is adjusted in " modification " mode (see § 1.2) :

- Press successively on key " A " to increase contrast.
- Press successively on key " B " to reduce contrast.
- Key " C " is used to restore the contrastsetting by default.

# KP07 VDU CONSOLE

## V. GENERAL TREE STRUCTURE OF SCREENS

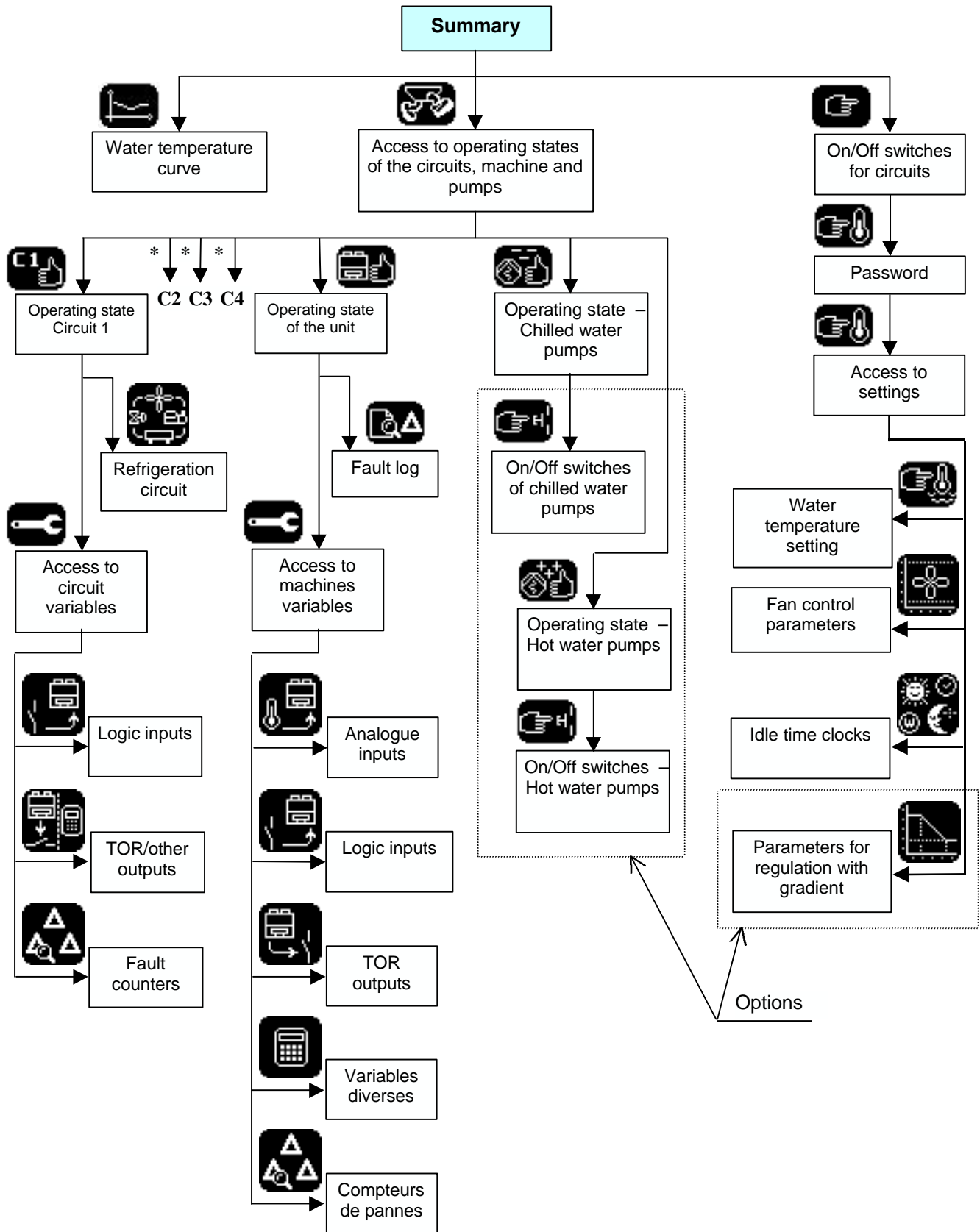

\* For units with more than one refrigeration circuit, branches C2, C3 and C4, corresponding to operating states for circuits 2, 3 and 4 respectively, are active.

# CONSOLE GRAPHIQUE KP07

## VI. VI. CONTENT OF SCREENS

### III.1. Summary

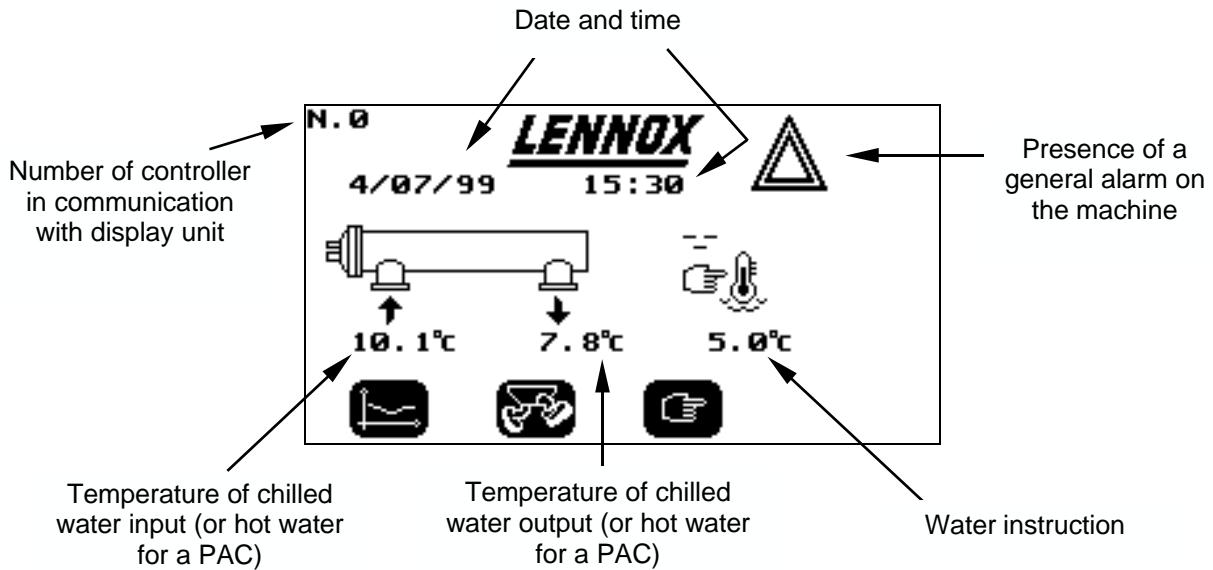

The water instruction is a variable which can be modified in "modification" mode. For a liquid cooler, the value displayed or entered is read or copied respectively into the active instruction ("A" or "B" depending on the value of the variable CHPCONS).

Where several KP01 cards are connected to the same KP07, the controller number can also be modified. On all other screens, the controller number can only be read.

Date and time data can also be changed. Every 24 hrs, the console automatically reads the date and time on the lowest JBUS address controller and sends this information to any other controllers connected to it.

### III.2. Water output temperature curve

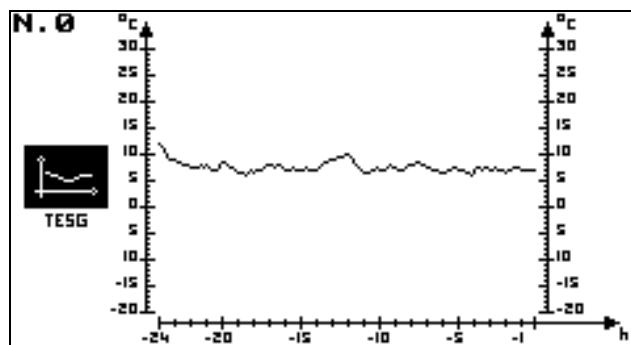

The monitoring frequency for the temperature of chilled water output (or hot water for a PAC) is 10 minutes, over a complete 24 hour cycle. The console therefore memorises the last 144 values of the monitored variable.

# KP07 VDU CONSOLE

## III.3. Access to the different operating states

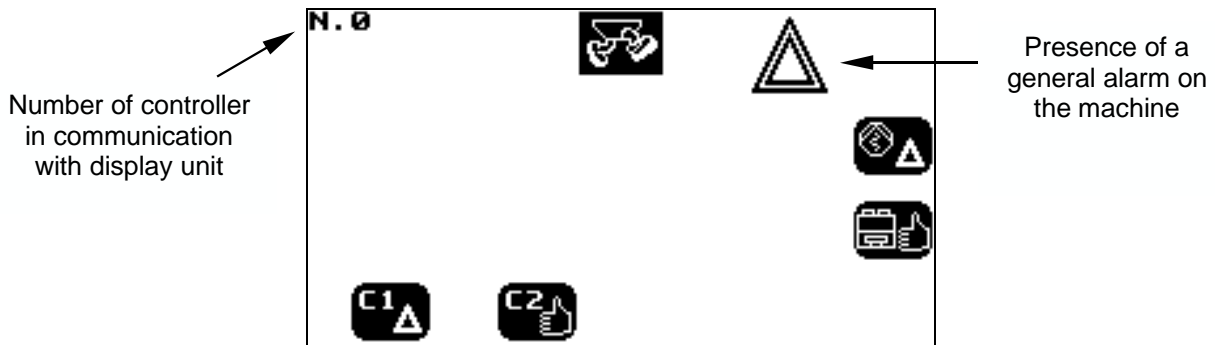

This screen gives access to the operating states of the refrigeration circuits, pumps and machine.

## III.4. Operating states of refrigeration circuits

Operating states of circuit compressors displayed (on / off at full power / on at reduced setting)

Nature of any fault present on the compressor

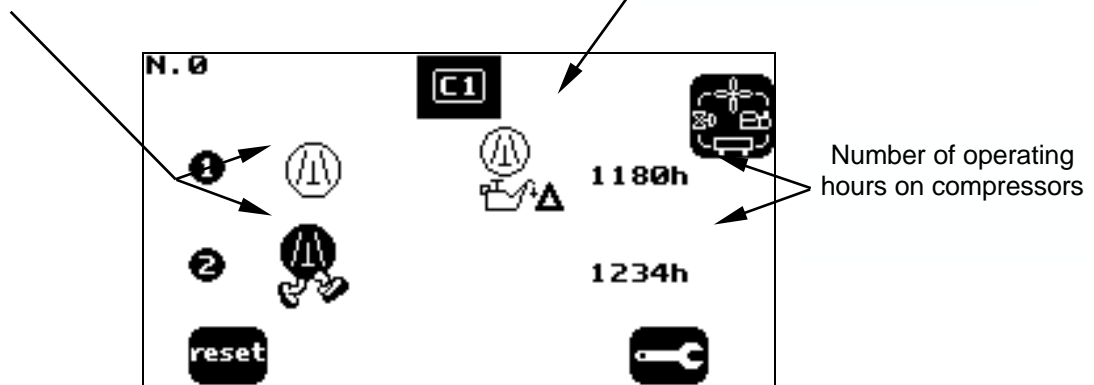

Cause of compressor halt other than a fault (e.g. : anti-short cycle)

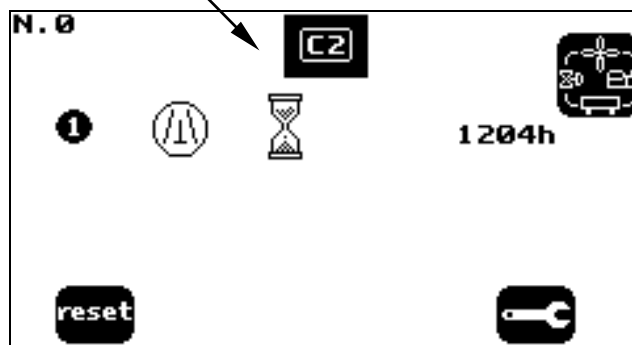

# KP07 VDU CONSOLE

## III.5. Refrigeration diagrams

### III.5.a. Groupes à condensation par air

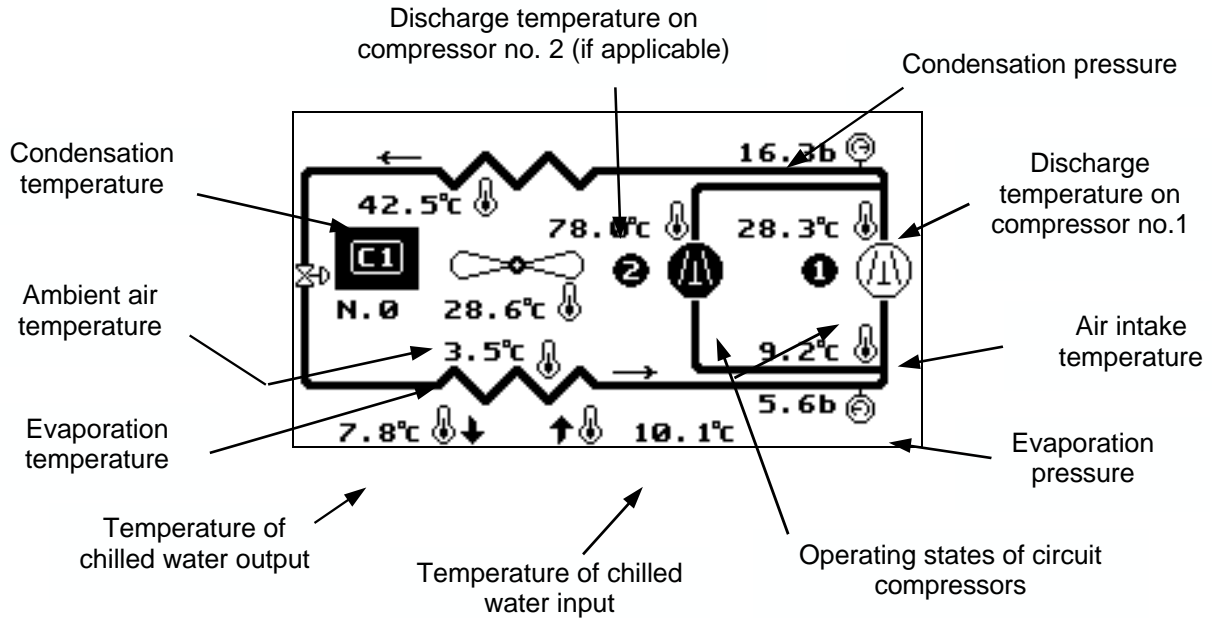

### III.5.b. Water cooled condensers

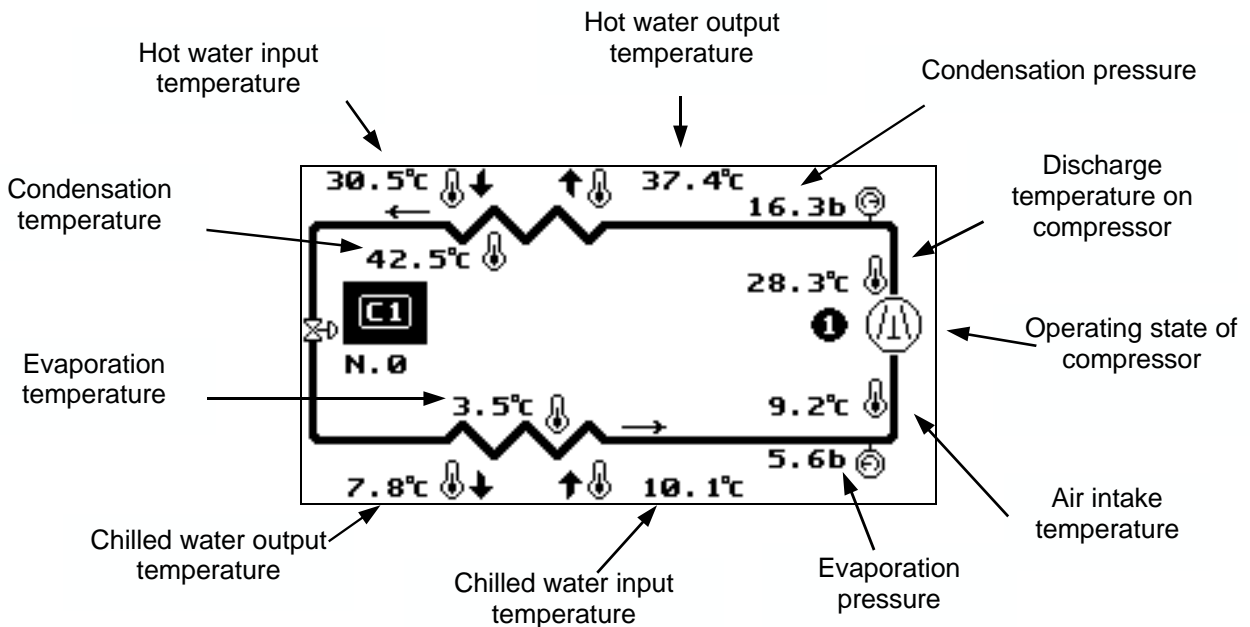

# KP07 VDU CONSOLE

## III.6. Tables of variables associated with refrigeration circuits

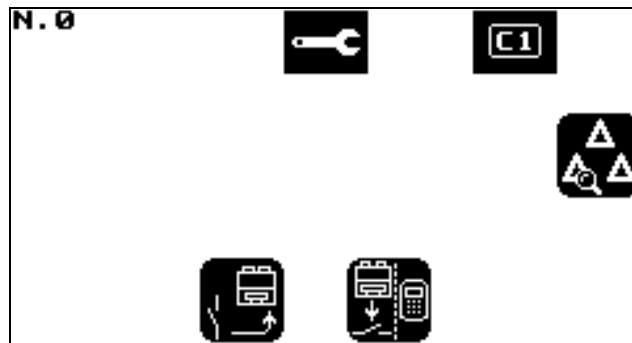

This screen gives access to the values of logic inputs, fault counters, TOR output and other variables describing the selected refrigeration circuit. Each variable is identified by its mnemonic.

### III.6.a. Logic inputs

<b>N. 0</b>		<b>C1</b>	
<b>MAAR1</b>	<b>ON</b>		
<b>PBP1</b>	<b>ON</b>		
<b>ELEC11</b>	<b>ON</b>	<b>ELEC21</b>	<b>ON</b>
<b>PHP11</b>	<b>ON</b>	<b>PHP21</b>	<b>OFF</b>
<b>PINT11</b>	<b>ON</b>	<b>PINT21</b>	<b>ON</b>
<b>POIL11</b>	<b>ON</b>	<b>POIL21</b>	<b>OFF</b>

This screen shows the state of all the logic inputs associated with the circuit and its compressors.

### III.6.b. Fault counters

<b>N. 0</b>		<b>C1</b>	
<b>TOBP1</b>	<b>0</b>		
<b>TOGEL1</b>	<b>0</b>		
<b>TOHP11</b>	<b>0</b>	<b>TOHP21</b>	<b>0</b>
<b>TOREF11</b>	<b>0</b>	<b>TOREF21</b>	<b>0</b>
<b>T00IL11</b>	<b>0</b>	<b>T00IL21</b>	<b>1</b>

This screen shows the values of counters for all faults on the circuit and its compressors.

# KP07 VDU CONSOLE

## III.6.c. TOR outputs and other variables

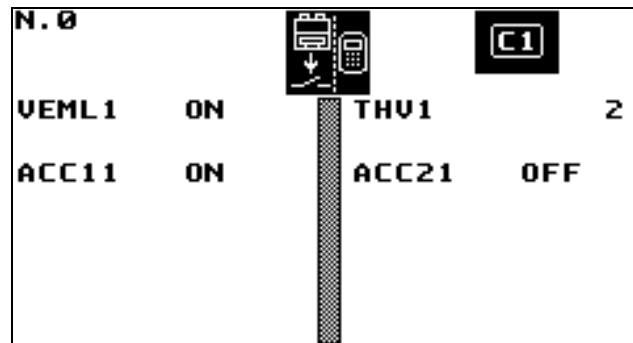

This screen shows the state of the of actuators which command circuit components other than the compressors, whose operation has already been described in operating states for circuits (see § III.4.). This screen also displays significant calculation variables for the circuit, such as the anti-short cycle for compressors.

## III.7. Pump operating states

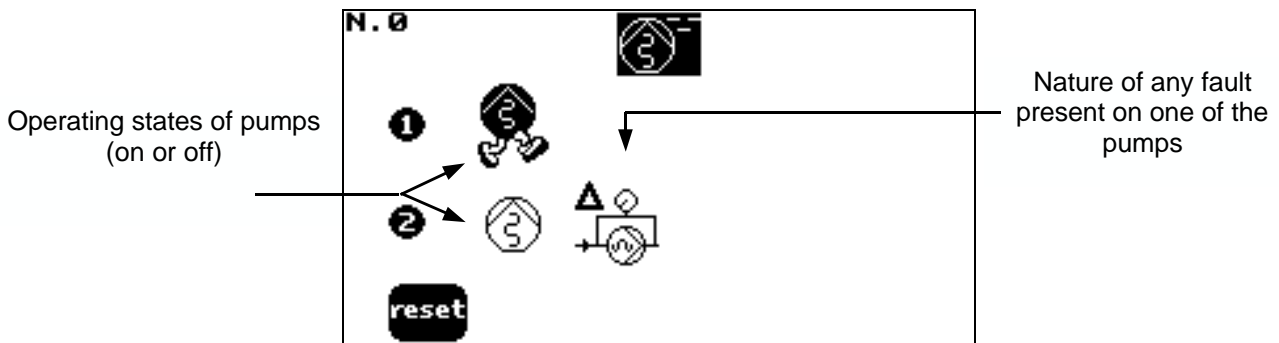

## III.8. Machine operating states

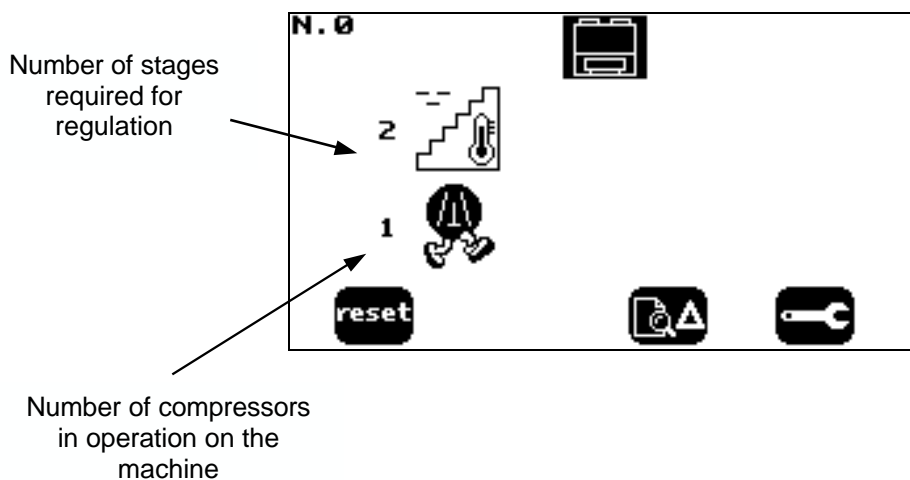



# KP07 VDU CONSOLE

## III.9. Tables of general variables

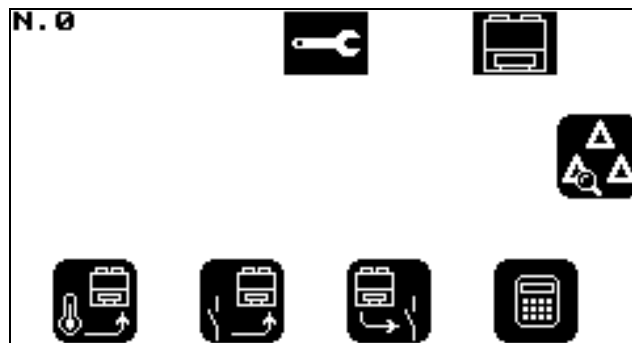

This screen gives access to the values of analogue inputs, logic inputs, TOR outputs, fault counters, and other variables relating to the entire machine (not related to a specific refrigeration circuit). Each variable is identified by its mnemonic.

### III.9.a. Analogue inputs

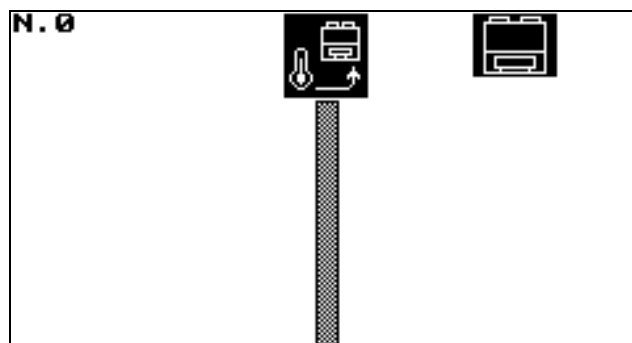

This screen contains the temperatures associated with specific options (e.g.: temperature of hot water output from heat recovery / temperature of chilled water output from free-cooling).

### III.9.b. Logic inputs

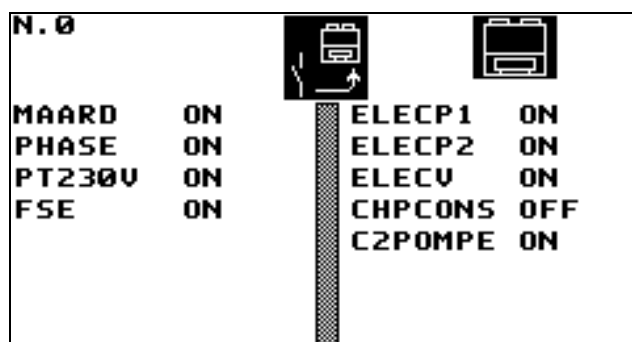

This screen shows the states of contacts which have an effect on the overall operation of the machine (e.g.: remote on / off, circuit breakers for pumps, choice of setting instruction, etc.)

# KP07 VDU CONSOLE

## III.9.c. TOR outputs

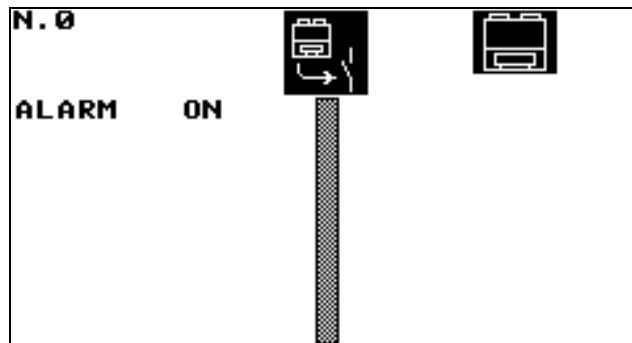

This screen displays the state of the actuators which control machine components (other than those already described in operating states for circuits and pumps).

## III.9.d. Fault counters

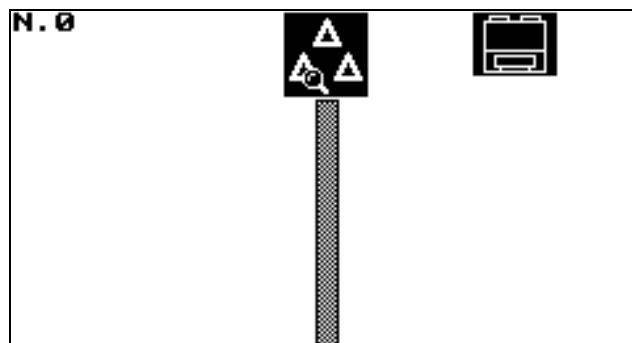

Faults and fault counters associated with specific options appear on this screen.

## III.9.e. other variables

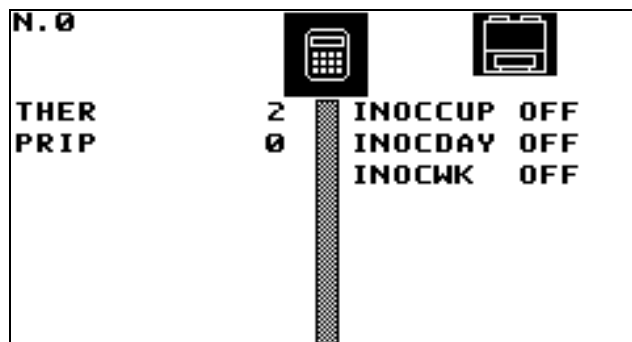

This screen gives the values of calculated variables which apply to the entire machine. (e.g.: priority status for pump operation, pump operation, idle functions, etc.)

# CONSOLE GRAPHIQUE KP07

## III.10. Fault log

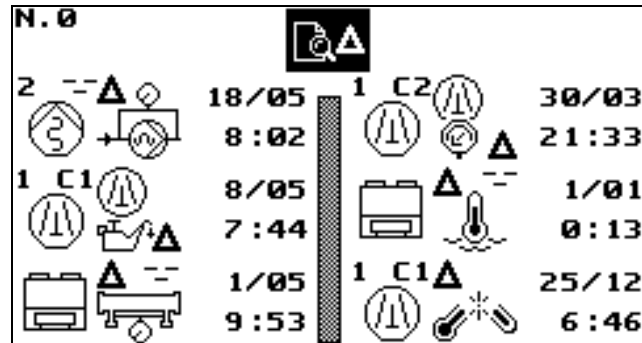

N. Ø		[Icon]	
2	18/05	1 C2	30/03
[Icon]	8:02	[Icon]	21:33
1 C1	8/05	[Icon]	1/01
[Icon]	7:44	[Icon]	0:13
[Icon]	1/05	1 C1	25/12
[Icon]	9:53	[Icon]	6:46

The event log can be used, depending on the configuration chosen in the console application program, to record :

- either the last 24 fault occurrences
- or the last 24 fault occurrences **and** clearances .

The log displayed relates only to the controller which is currently in communication with the display unit. If other KP01 cards are linked to this display unit, their respective event logs can be accessed by modification of the controller number in the summary screen (see § III.1.).

## III.11. On / off switches on refrigeration circuits

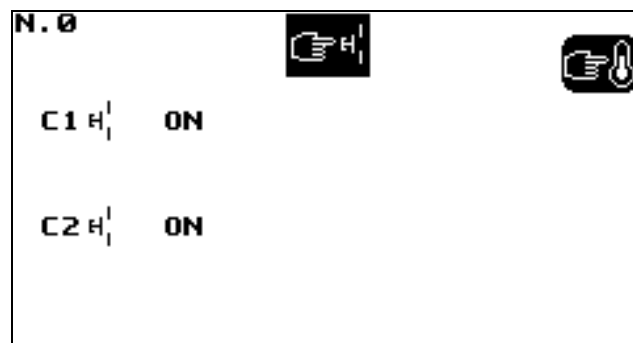

N. Ø		[Icon]		[Icon]	
C1	H <sub>1</sub>	ON			
C2	H <sub>1</sub>	ON			

This screen can be used to configure authorisation to switch on each refrigeration circuit, or to keep it switched off, using "modification" mode.

# CONSOLE GRAPHIQUE KP07

After pressing key , the screen shows :

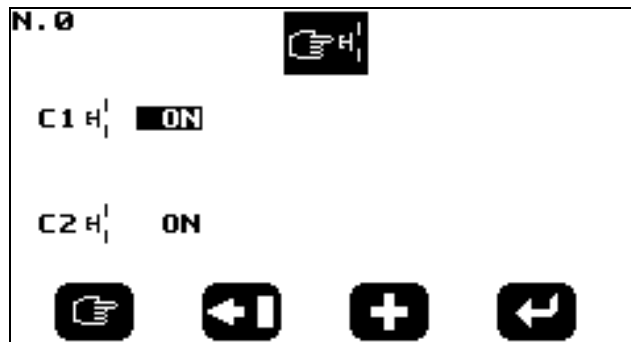

## III.12. Instructions

Access to the different setting instructions is protected by a password (a modifiable variable consisting of 5 figures). This is entered via "modification" mode.



Entry of the password, followed by validation, activates key "A":



Pressing key "A" displays the screen below, enabling the user to access the type of instruction he/she wishes to adjust.

# KP07 VDU CONSOLE

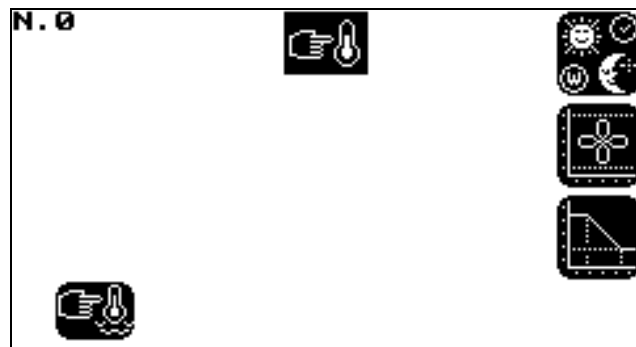

All the instructions which follow can be adjusted via the "modification" mode.

## III.12.a. Water temperature instructions

The screen shown below corresponds to the case of a liquid cooler. There is a similar screen for heat pumps.

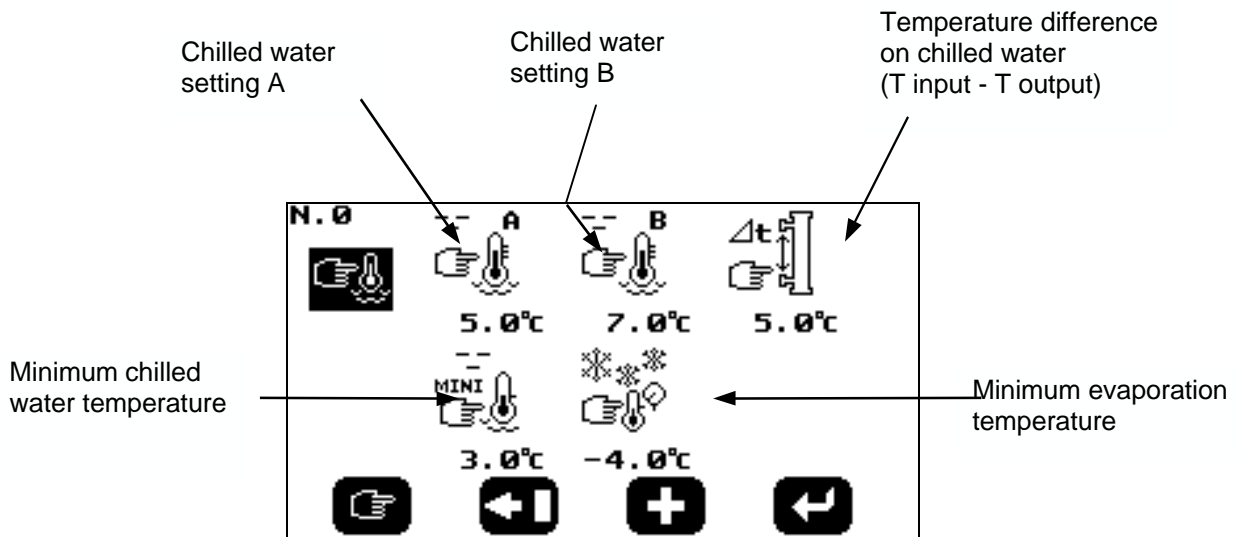

## III.12.b. Control parameters for condenser ventilation

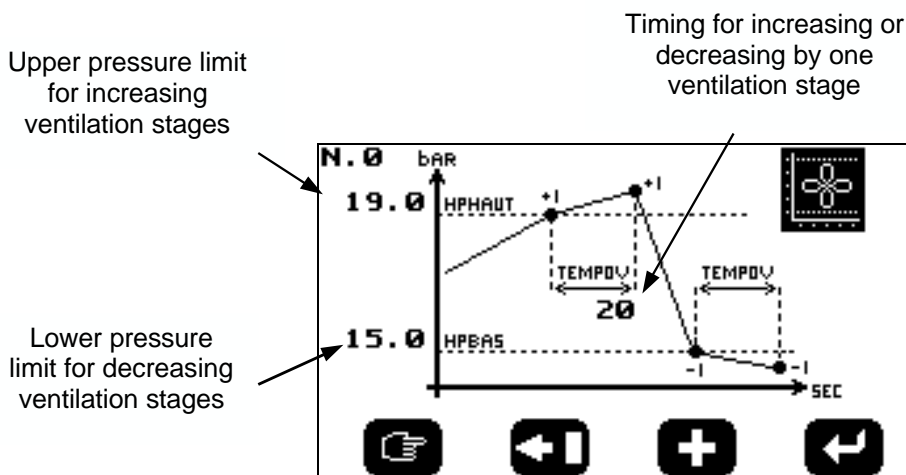

# KP07 VDU CONSOLE

## III.12.c. Idle time clocks

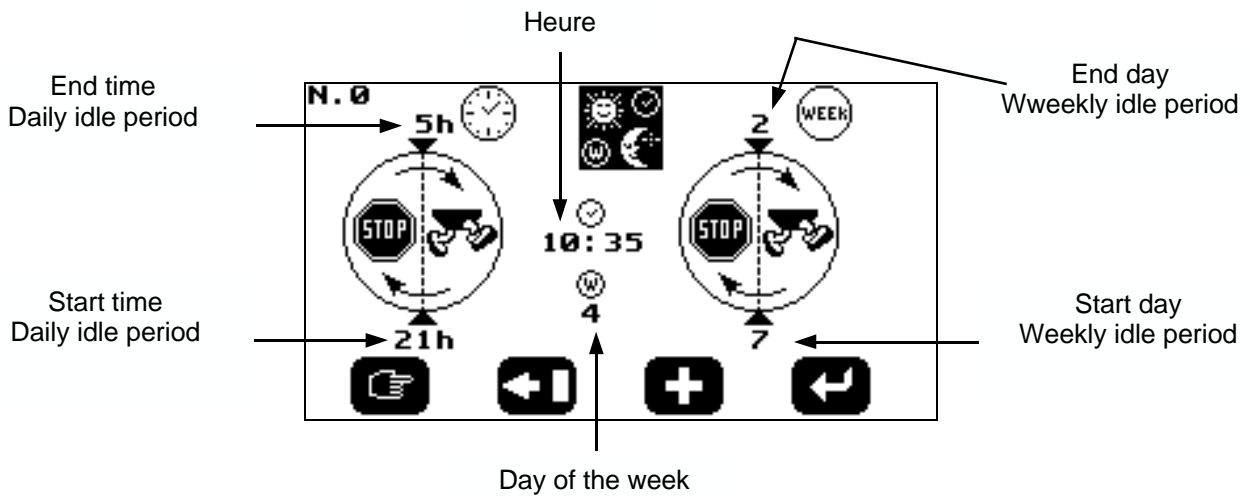

Date and hour variables can be changed, as any instruction showed on this screen.

## III.12.d. Parameters for regulation with gradient on air temperature (option)

The screen below corresponds to the case of a liquid cooler.

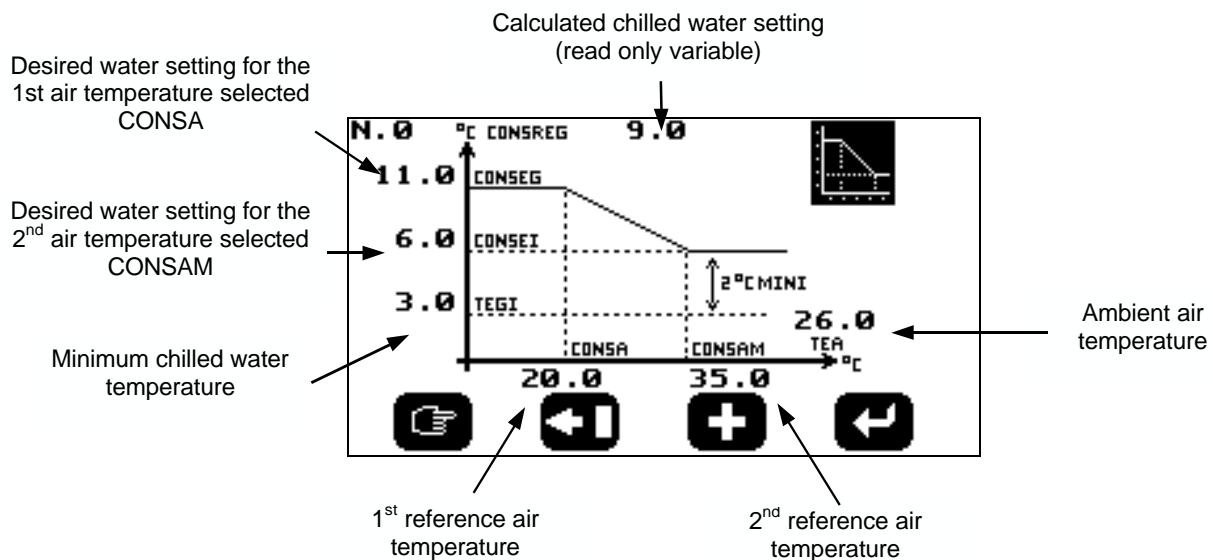

# KP07 VDU CONSOLE

## VII. GLOSSARY OF ICONS

Icons are classed in 6 categories:

1. Keys
2. Screen headings
3. Identification of components
4. Operating states
5. Faults
6. On / off settings and instructions

### IV.1. Keys



Access to the temperature curve for water output from machine.



Access to operating states for refrigeration circuits, pumps and machine



Access to operating state for refrigeration circuit no.1 (no faults are reported on the circuit)



Access to operating state for refrigeration circuit no.1 (there is a fault on the circuit).



Access to operating state for refrigeration circuit no.2 (no faults are reported on the circuit).



Access to operating state for refrigeration circuit no.2 (there is a fault on the circuit).



Access to operating state for refrigeration circuit no.3 (no faults are reported on the circuit).



Access to operating state for refrigeration circuit no.3 (there is a fault on the circuit).



Access to operating state for refrigeration circuit no.4 (no faults are reported on the circuit).



Access to operating state for refrigeration circuit no.4 (there is a fault on the circuit).



Access to operating state for chilled water pumps (no faults are reported on the pumps).



Access to operating state for hot water pumps (no faults are reported on the pumps).



Access to operating state for hot water pumps (there is a fault on the pumps).



Access to operating state for hot water pumps (there is a fault on the pumps).



Access to operating state for machine (there is a fault on the machine).



Access to operating state for machine (there is a fault on the machine).



Reset faults and fault counters to zero.



Access to refrigeration diagram for selected circuit.

# KP07 VDU CONSOLE



Access to fault log.



Access to the different tables of variables.



Access to analogue inputs (other than those shown on refrigeration diagrams).



Access to logic inputs.



Access to TOR outputs.



Access to TOR outputs and other variables associated with the selected refrigeration circuit.



Access to miscellaneous variables.



Access to fault counters.



Access to on / off controls and instructions.  
Selection of the variable to be modified (see §I.2.).



Selection of figure to be modified (see §I.2.)



Incrementation of figure from 0 to 9 (see §I.2.).



Validation of current modification (see §I.2.).



Access to on / off controls for refrigeration circuits.



Access to the various instructions.



Access to water temperature instructions.



Access to control parameters for condenser fan.



Access to idle timers (day / night).



Access to parameters for regulation with gradient on air temperature.

## IV.2. Screen headings

























Temperature curves for water output from the machine.



Access to operating states for refrigeration circuits, pumps and machine.



# KP07 VDU CONSOLE

-  Operating state of refrigeration circuit no.1.
-  Operating state of refrigeration circuit no.2.
-  Operating state of refrigeration circuit no.3.
-  Operating state of refrigeration circuit no.4.
-  Operating state of chilled water pumps.
-  Operating state of hot water pumps.
-  Operating state of machine.
-  Fault log.
-  Access to the different tables of variables.
-  Analogue inputs (other than those shown on refrigeration diagrams).
-  Logic inputs.
-  TOR outputs.
-  TOR outputs and other variables associated with selected refrigeration circuit
-  Miscellaneous variables.
-  Fault counters.
-  On / off controls for refrigeration circuits.
-  On / off controls for chilled water pumps.
-  On / off controls for hot water pumps.
-  Password entry for access to modifiable instructions.
-  Access to the various instructions.
-  Water temperature instructions.
-  Control parameters for condenser fan.

# KP07 VDU CONSOLE



Parameters for regulation with gradient on air temperature.



Idle timers (day / night).

## **IV.3. Identification of components**



Machine.



Refrigeration circuit no. 1



Refrigeration circuit no. 2



Refrigeration circuit no. 3



Refrigeration circuit no. 4



Compressor or pump no. 1 (in " circuits or pumps " operating states respectively).



Compressor or pump no. 2 (in " circuits or pumps " operating states respectively).



Compressor no. 1 for refrigeration circuit no. 1



Compressor no. 2 for refrigeration circuit no. 1



Compressor no. 1 for refrigeration circuit no. 2



Compressor no. 2 for refrigeration circuit no. 2



Compressor no. 1 for refrigeration circuit no. 3



Compressor no. 1 for refrigeration circuit no. 4



Chilled water pump no. 1.



Chilled water pump no. 2

# CONSOLE GRAPHIQUE KP07



Hot water pump no. 1.



Hot water pump no. 2.

## **IV.4. Operating states**



Stages required for chilled water regulation.



Stages required for hot water regulation.



Compressor in operation (representation on refrigeration diagram).



Compressor in operation.



Compressor in operation at full capacity.



Compressor in operation at reduced capacity.



Compressor operating at 75% of its total capacity



Compressor operating at 50% of its total capacity.



Compressor operating at 25% of its total capacity.



Compressor stopped (representation on refrigeration diagram).



Compressor stopped.



Compressor stopped for regulation.



Compressor stopped in anti-short cycle.



Compressor stopped by idle timers



Compressor stopped by non operation of pump.

# CONSOLE GRAPHIQUE KP07



Compressor stopped by refrigeration circuit on/off.



Compressor stopped by remote on / off command to machine.



Pump in operation.



Pump stopped.

## IV.5. Faults



On the unit, presence of a machine, circuit compressor or miscellaneous fault

### IV.5.a. General machine faults



Chilled water temperature outside authorised range



Hot water temperature outside authorised range.



Chilled water flow insufficient.



Hot water flow insufficient.



Absence of power on 230 V electrical supply to the machine.



Incorrect connection of 3 phases of general electrical supply to the machine.

### IV.5.b. Faults on the refrigeration circuit



Low pressure insufficient.



Evaporator freezing.



Superheat insufficient.



Vacuum draught on circuit not achieved.

# KP07 VDU CONSOLE



Temperature sensors or pressure detectors faulty.



Incorrect opening of expansion valve.

## IV.5.c. Compressor faults



Tripping of thermomagnetic circuit breaker for compressor.



Insufficient oil pressure.



Excess high pressure.



Discharge temperature too high.



Tripping of internal protection for compressor.

## IV.5.d. Miscellaneous faults



Dialogue interrupted between 2 CPU cards on network.



Insufficient water flow although operational command has been issued to pump.



Tripping of thermomagnetic circuit breaker for at least one fan.



Tripping of thermomagnetic circuit breaker for pump.



Water tank level or pressure insufficient.



Bad reception of 4/20 mA signal transmitted remotely for water instruction.



Chilled water temperature at the input of free cooling outside authorised range.



Dialogue interrupted between KP07 console and a CPU card on the network.

# KP07 VDU CONSOLE

## IV.6. On / off settings and instructions



On / off refrigeration circuit no. 1.



On / off refrigeration circuit no. 2.



On / off refrigeration circuit no. 3.



On / off refrigeration circuit no. 4.



On/Off pump no. 1.



On/Off pump no. 2.



First chilled water setting (CONSEA).



Second chilled water setting (CONSEB).



Active chilled water setting (measured variable CONSREG)



First hot water setting (CONSEA).



Second hot water setting (CONSEB).



Active hot water setting (measured variable CONSREG)



Desired temperature difference, as an absolute value, between processed water input and output (DELTAT).



Minimum chilled water temperature (TEGI).



Maximum hot water temperature (TECS).



Minimum evaporation temperature (TBPI).

# ELECTRONIC CARD DATA

## CONTENTS

	Page
CLIMATIC CARD KP01 .....	79
EXTENSION - 16 LOGIC INPUTS KP03 .....	83
EXTENSION -ANALOGUE OUTPUT KP04 .....	84
EXTENSION - 8 ANALOGUE INPUTS KP05.....	85
EXTENSION - 8 RELAYS KP08 .....	86
EXTENSION - +18VDC SUPPLY KP10.....	87
FEMALE CARD -ANALOGUE OUTPUT KP11.....	89
DIGITAL CONSOLE KP02.....	90
VDU CONSOLE KP07 .....	91

# CLIMATIC CARD KP01

## ① General presentation

The CLIMATIC consists of a main KP01 microcontroller card, with 8 analogue inputs, 8 logic inputs and 8 logic outputs in its standard version. Two analogue outputs and a +18Vdc supply are also available as an option.

- ☞ Logic inputs are linked to hard contacts.
- ☞ Analogue inputs are linked to temperature or pressure detectors.
- ☞ Outputs are connected to control contactors (compressors, fans, etc.).

Modules can be added to the system using extension cards :

- ☞ 3 extensions - 16 logic inputs (KP03 card)
- ☞ 4 extensions - analogue output (KP04 card)
- ☞ 3 extensions - 8 analogue inputs (KP05 card)
- ☞ 4 extensions - 8 supplementary logic outputs (KP08 card)
- ☞ 2 asynchronous serial links for dialogue with:
  - a micro-computer or a VDU console (1200, 2400 or 4800 baud).
  - a basic digital console (KP02), and/or a VDU console with LCD display unit (KP07).

## ② Replacement of a KP01 card

Procedure to be followed :

- ☞ Note the values of all settings.
- ☞ Turn off the power supply to the card and change the card.
- ☞ Retrieve the EPROM from the old card and fit it to the new one (see drawing below).
- ☞ Reconnect all the connections to the CLIMATIC, referring to the wiring diagram.
- ☞ Set the battery jumper to position "on" (T) together with the various configuration jumpers.
- ☞ Turn the power supply to the card back on and enter the old settings on the new card.

Note : Never connect or disconnect the I<sup>2</sup>C connectors when the power supply to the card is on.

Positioning direction for the EPROM :

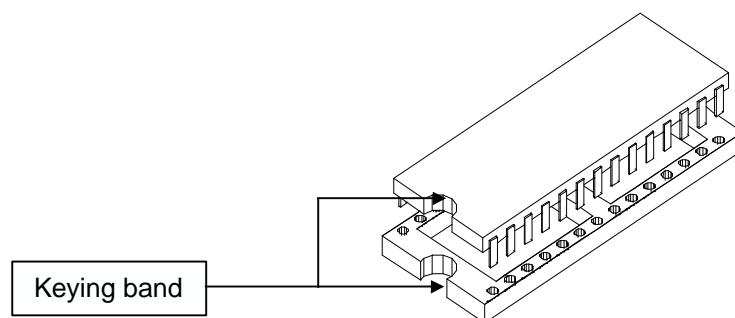



# CLIMATIC CARD KP01

## ③ Supply

A single transformer provides the power supply to the Climatic and its extensions :

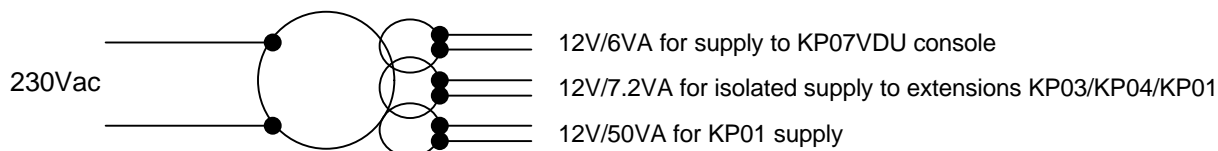

## ④ Switches

### ☞ SW2, SW3 :

By default, the card is configured in

If there is a link between cards (maximum 8), set switches as follows:

- Card 0 (master) internal supply: SW2 and SW3 = 1-2
- Card n (slave) external supply: SW2 and SW3 = 2-3 (card 0 supplies the link)

### ☞ SW4 :

This switch turns the battery on or off.

Caution: the dater will not work if the battery is not in position "on".

### ☞ SW5-1 à SW5-8:

These switches are used to configure the type of analogue input (CTN / 0-20mA / 0-5V).

Caution: every addition of a KP05 extension (1 to 3) causes an analogue input (1 to 3) on the main KP01 unit to become unavailable. In this case, the switches for the corresponding inputs (SW5-1 to SW5-3) must be set to "inactive", i.e. neither on position CTN, nor on 0-20mA, but simply withdrawn.

## ⑤ Bus I<sup>2</sup>C

Never handle the I<sup>2</sup>C bus when the power is switched on.



# CARTE CLIMATIC KP01

## Key :

J1 to J8:	3 point removable pin connectors, pitch 5.08 for 8 changeover relays
J10:	3 point removable pin connectors, pitch 5.08 for 12Vac supply and Earth
J11:	2 point removable pin connectors, pitch 3.81 for 12Vac isolated supply
J13:	3 point removable pin connectors, pitch 3.81 for card chaining
J14, J15:	RJ45 connectors for I <sup>2</sup> C bus
J17, J21:	2 point removable pin connectors, pitch 3.81 for 2 analogue outputs
J18, J22:	4 point removable pin connectors, pitch 3.81 for 2 serial links
J24:	2 point removable pin connectors, pitch 3.81 for +18Vdc supply
J25:	12 point removable pin connector, pitch 3.81 for analogue inputs
J26:	12 point removable pin connector, pitch 3.81 for logic inputs
PT1, PT2:	12Vac
PT3:	0V isolated
PT6:	11V isolated
PT4:	Vcc(+5V)
PT5:	Gnd
PT7:	Vref
PT9:	Reset
PT10:	Power Fail
PT11, PT13:	12Vac isolated
PT12:	Clock
SW1:	DIL microswitches
SW2, SW3:	Configuration switches for internal or external supply to chaining link
SW4:	Battery switch (on or off)
SW5:	Configuration switch - type analogue input

# EXTENSION 16 ENTREES LOGIQUES KP03

The KP03 card is used for processing the 16 logic inputs (10V/10mA).

It is possible to connect up to 3 extensions to a KP01 card, to attain a maximum capacity of  $8 + 3 \times 16 = 56$  logic inputs.

The state of each input is shown by an LED.

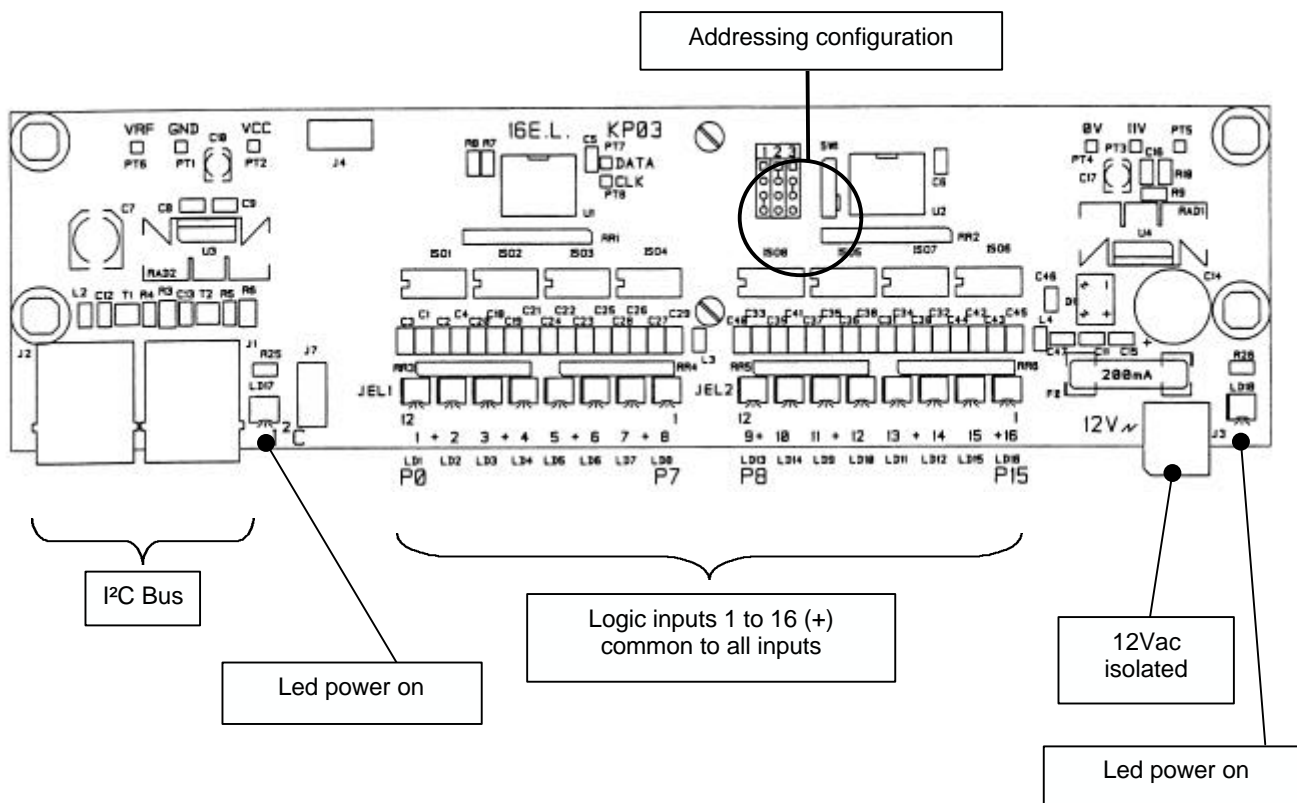

## Key :

- J1, J2: RJ45 connectors for I2C Bus
  - J3: 2 point removal pin connector, pitch 5.08 for 12Vac external supply
  - JEL1, JEL2: 12 point removal pin connectors, pitch 3.81 for logic inputs
  - J4, J7: Locations for connection to earth using FASTON 6.35 earth lugs
  - LD1, LD16: LED status of 16 inputs
  - LD17: LED presence of power from KP01
  - LD18: LED presence of 12Vac isolated power
  - SW1: Switch for the configuration of the card address
- The position of jumpers for each configuration is marked on the card.
- PT1: Earth
  - PT2: Vcc1 (+5V)
  - PT3: Vcc2 (+11V isolated)
  - PT4: 0V isolated
  - PT5: +12V rectified and filtered (before regulation)
  - PT6: VRF
  - PT7: SDA/I2C signal (DATA)
  - PT8: SCL/I2C signal (CLOCK)

# EXTENSION ANALOGUE OUTPUT KP04

The KP04 card provides, via a digital/analogue converter, analogue output (0-10V), resolution 39mV.

It is possible to connect up to 4 KP04 extensions to the same CPU, which offers a maximum capacity of  $2 + 4 \times 1 = 6$  analogue outputs.

The card is calibrated by adjusting the potentiometer P1.

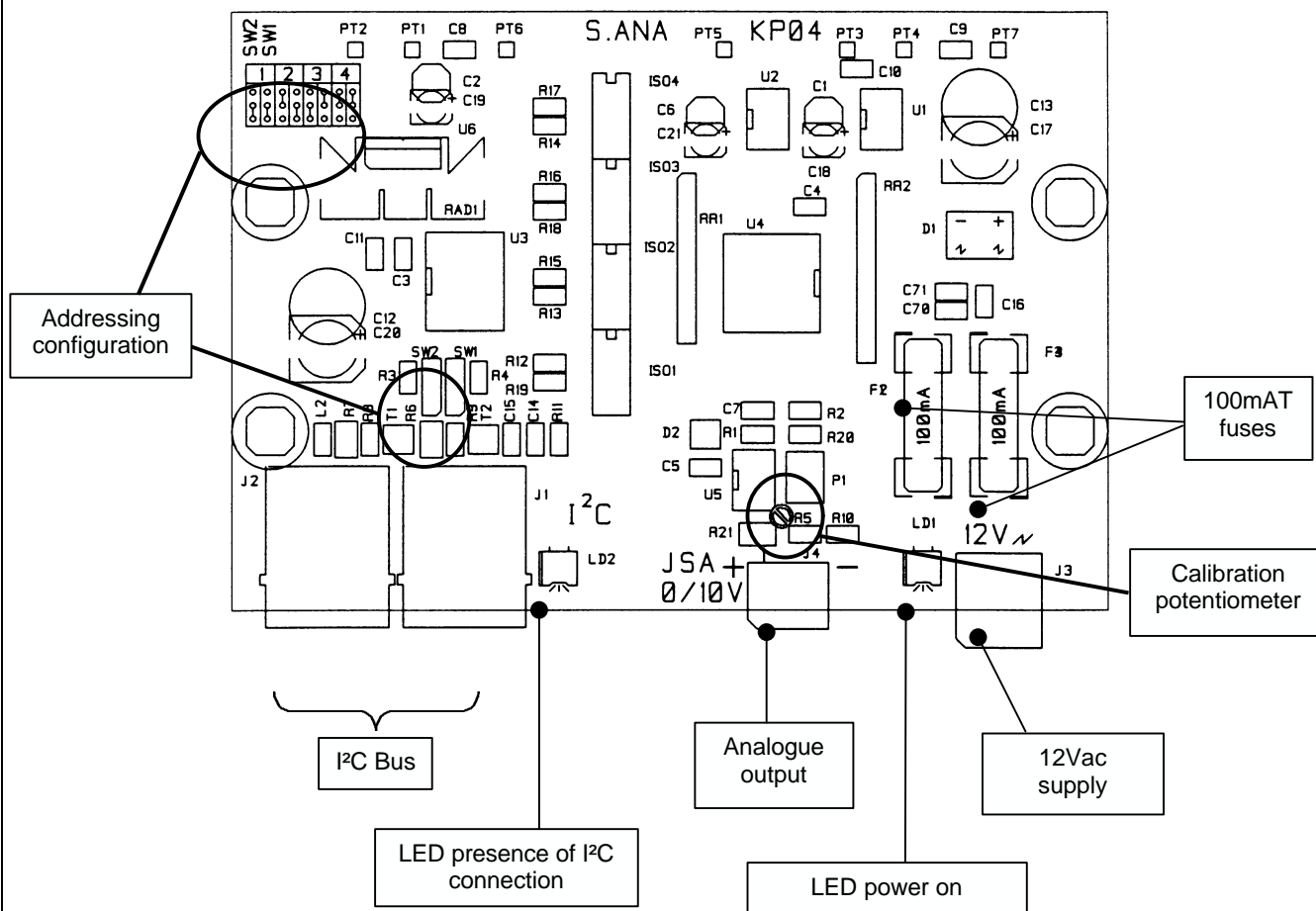

## Key :

- J1, J2: RJ45 connectors of the Bus I<sup>2</sup>C
  - J3: 2 point removable pin connector, pitch 5.08 for external 12Vac supply
  - J4 (JAS.): 2 point removable pin connector, pitch 3.81 for analogue output 0-10V
  - SW1, SW2: Switches for configuration of the card address
- The position of jumpers for each configuration is marked on the card.
- LD1: LED presence of power
  - LD2: LED presence of dialogue
  - P1: Potentiometer for card calibration (adjustment of amplitude)
  - PT1: Earth
  - PT2: VRF
  - PT3: +12V isolated
  - PT4: 0V isolated
  - PT5: +5V isolated
  - PT6: Vcc (+5V)
  - PT7: +12V rectified and filtered (before adjustment)

# EXTENSION 8 ENTREES ANALOGIQUES KP05

The KP05 card is used for the acquisition of 8 analogue inputs. These inputs may connect either a CTN temperature sensor (10K $\Omega$  at 25°C), or a conventional 0-20mA detector (via the +18Vdc supply). The type of element connected is configured using switch SW1.

It is possible to connect up to 3 KP05 extensions to the same CPU card. Every addition of a KP05 means that a KP01 analogue input becomes unavailable. The complete configuration therefore allows a maximum number of  $5 + 3 \times 8 = 29$  inputs.

**Note :** Inputs 5 to 8 are not equipped to receive a 0-20mA signal. In fact resistors R10 to R14 (249 $\Omega$ /0.1%) are not fitted in the original configuration.

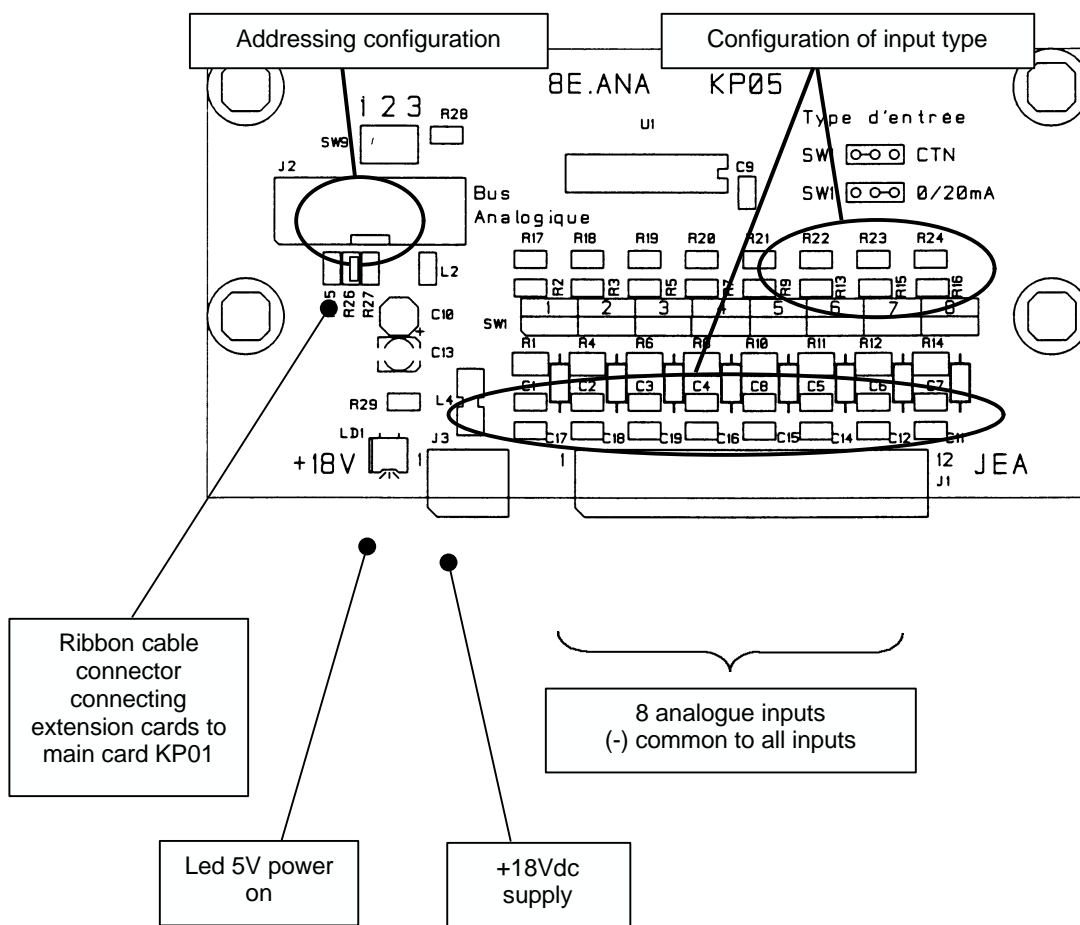

## Key :

- J1 (JEA): 12 point removable pin connector , pitch 3.81 for analogue inputs
- J2: 14 point HE10 connector for analogue bus
- J3: 2 point removable pin connector, pitch 3.81 for the two outputs +18Vcontinuous
- LD1: LED presence of power
- SW1 to SW8: Jumpers for the configuration of 0-20mA inputs or CTN  
The position of jumpers, depending on the type of input, is marked on the card.
- SW9: Switches for configuration of the card address.

# EXTENSION 8 RELAYS KP08

The KP08 card carries 8 outputs on changeover relays (16A/250Vac).

It is possible to connect up to 4 KP08 cards to the same CPU, offering a maximum number of  $8 + 4 \times 8 = 40$  discrete outputs.

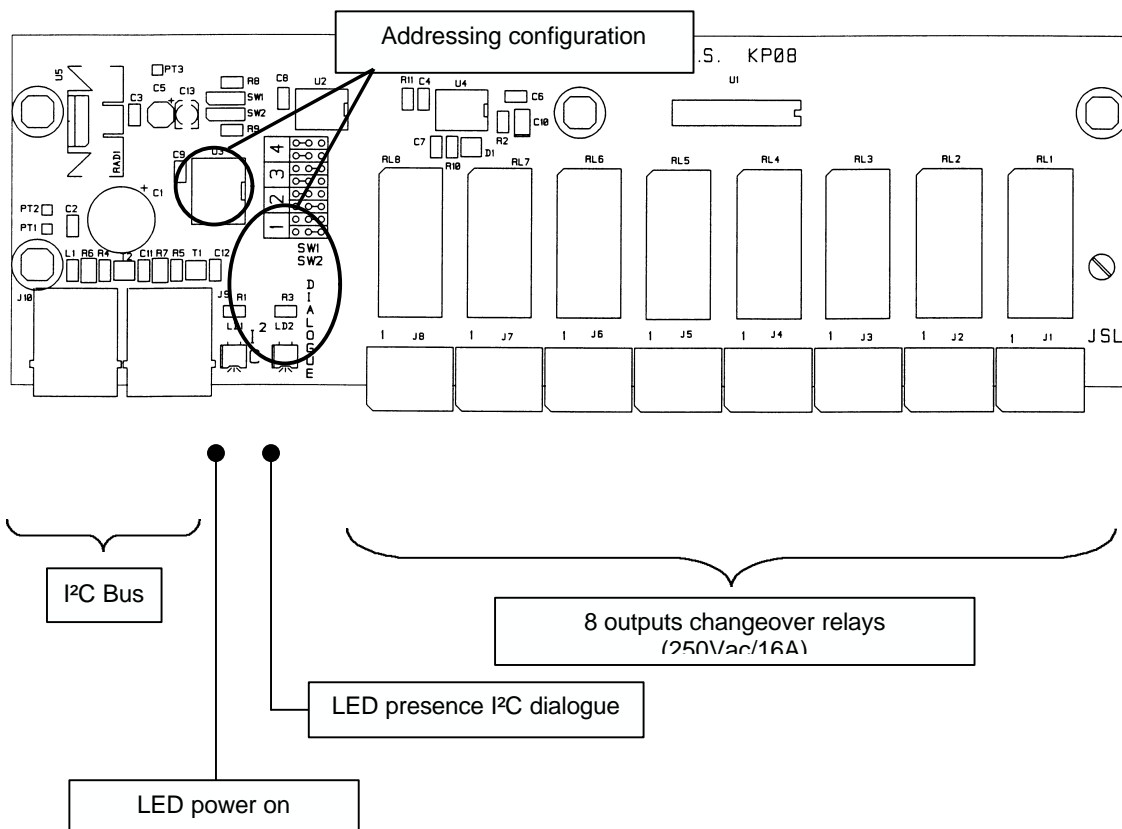

## Key :

- J1 to J8: 3 point removable pin connector , pitch 5.08 for double-throw contacts for relays RL1 to RL8
- J9, J10: RJ45 connector for I2C Bus
- LD1: LED presence of power from KP01
- LD2: LED presence of I2C dialogue
- SW1, SW2: Switches for configuration of the card address  
The position of jumpers for each configuration is marked on the card.
- PT1: VRF
- PT2: Earth
- PT3: Vcc (+5V)

# EXTENSION ALIMENTATION +18VDC KP10

## Presentation :

The KP10 extension is presented in the form of a small plug-in card positioned on the main KP01 unit and designed to supply detectors type 0-20mA.

## Precautions :

When installing the module, take care to comply with the circuit orientation as printed on the main KP01 unit.

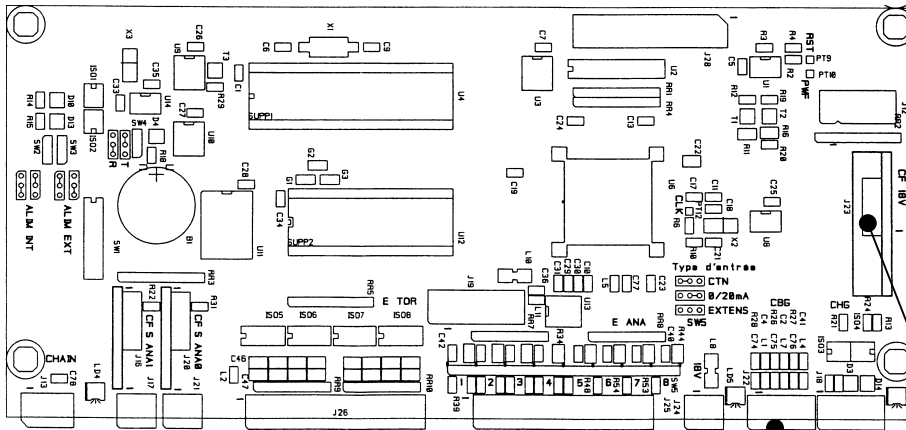
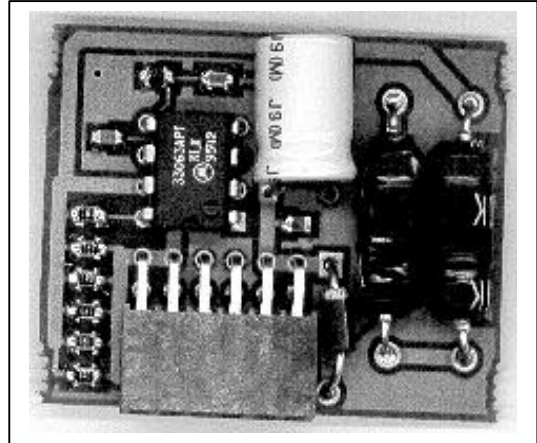

Location on KP01 card

Output connector

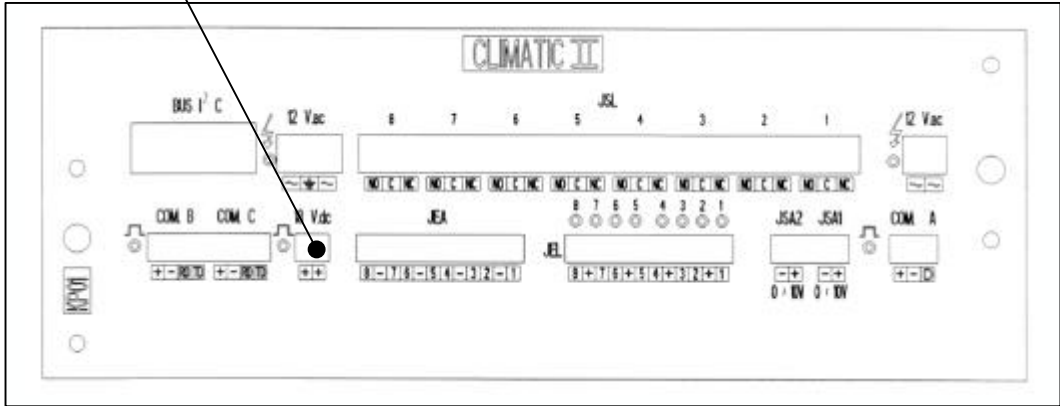



# CARTE FILLE SORTIE ANALOGIQUE KP11

## Presentation :

The KP11 extension is presented in the form of a small plug-in card positioned on the main KP01 unit. It supplies analogue voltage 0-10Vdc/10mA  
A CPU may receive 2 cards KP11 at the most.

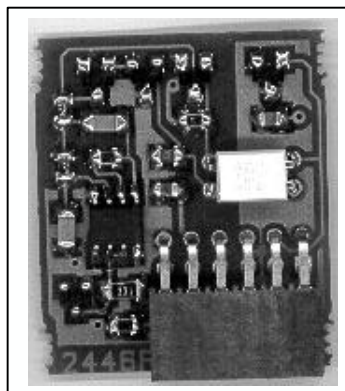

## Precautions :

When installing the module, take care to comply with the circuit orientation as printed on the main KP01 unit.

Location of modules  
and output connectors  
on the KP01 card

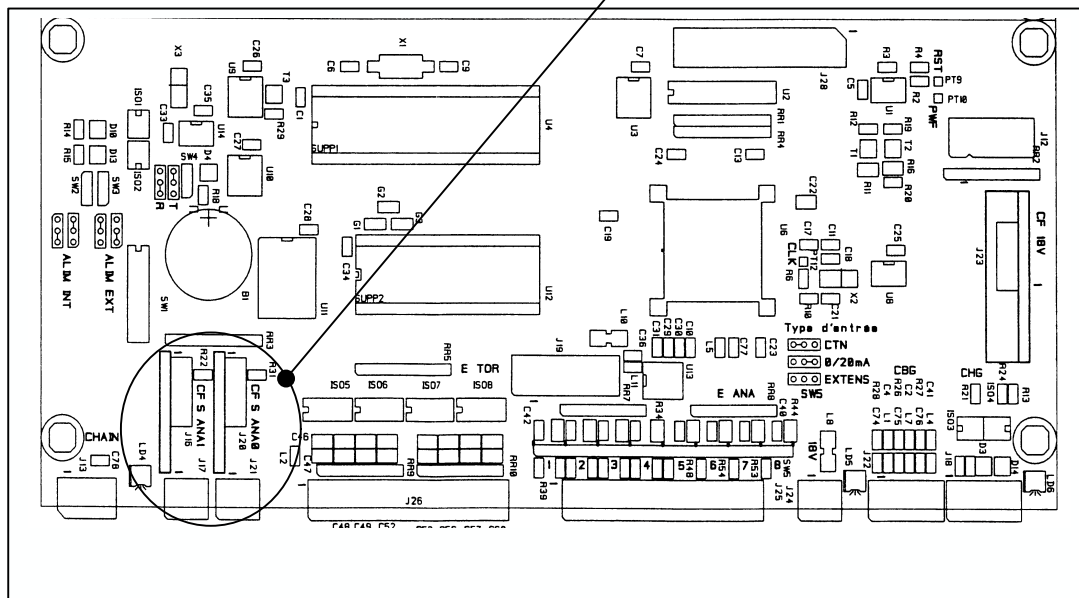

# DIGITAL CONSOLE KP02

## 1 Internal wiring

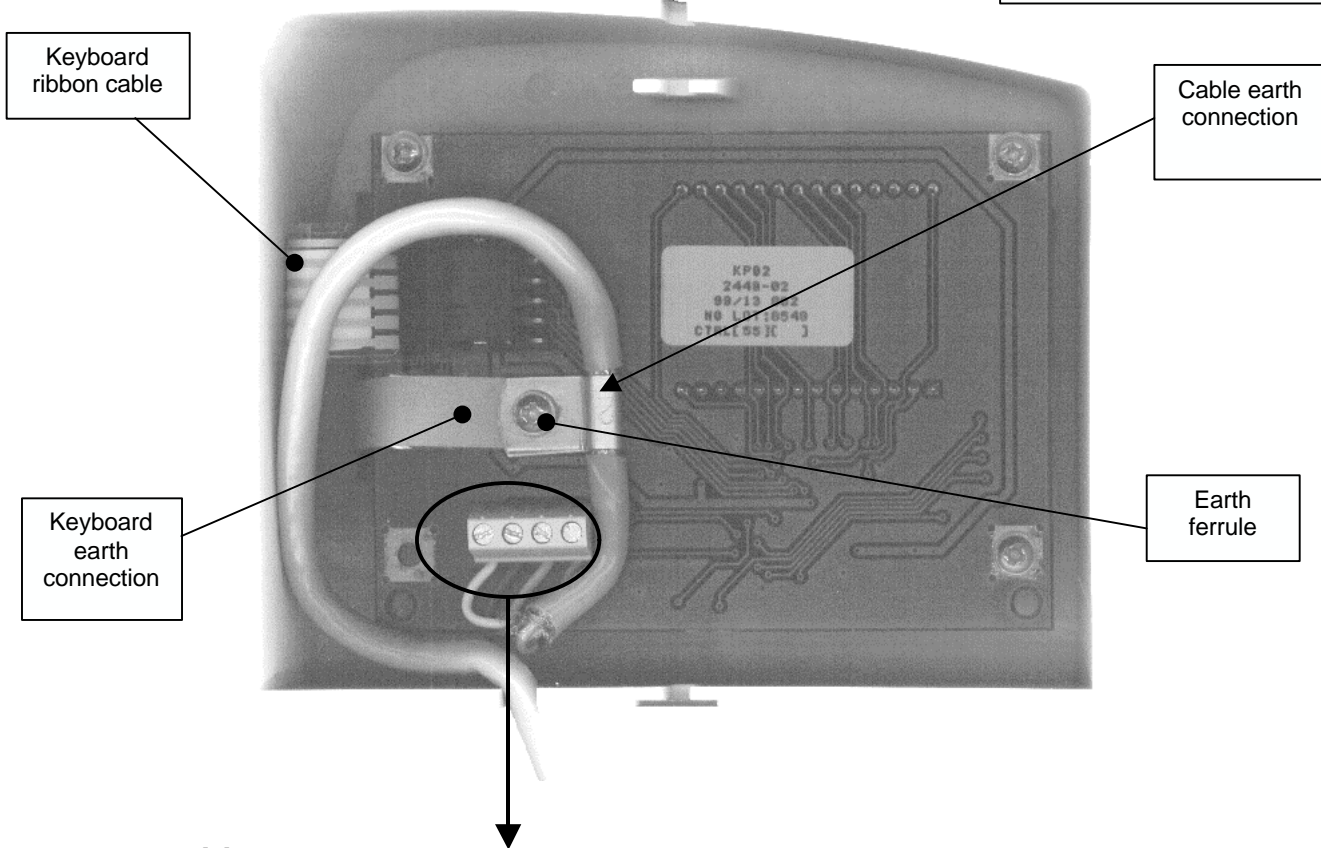
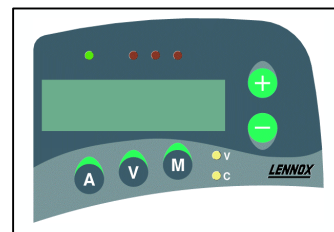

## 2 External wiring

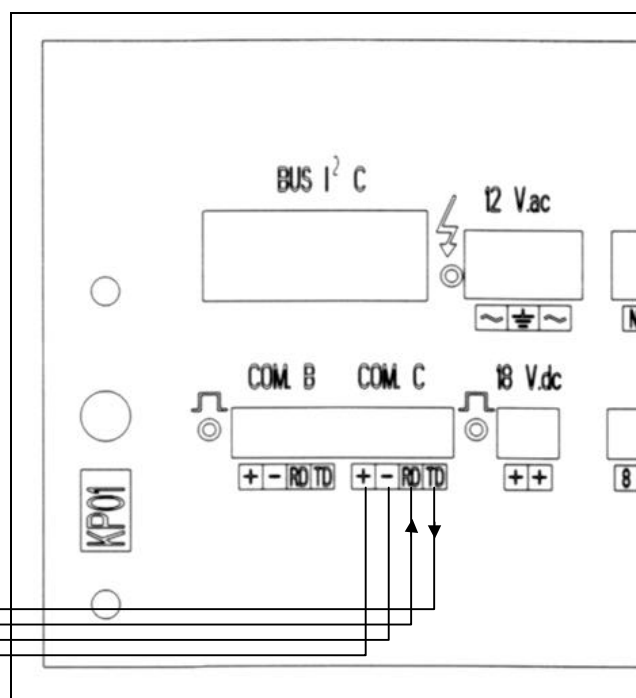
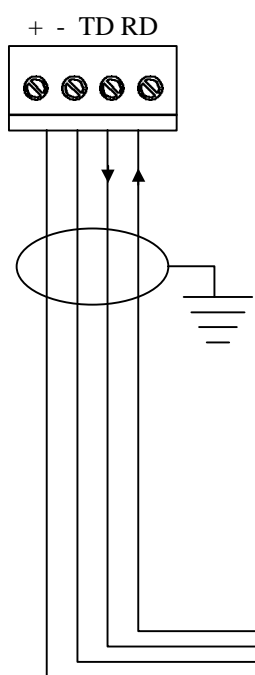

# CONSOLE GRAPHIQUE KP07

## 1 Presentation

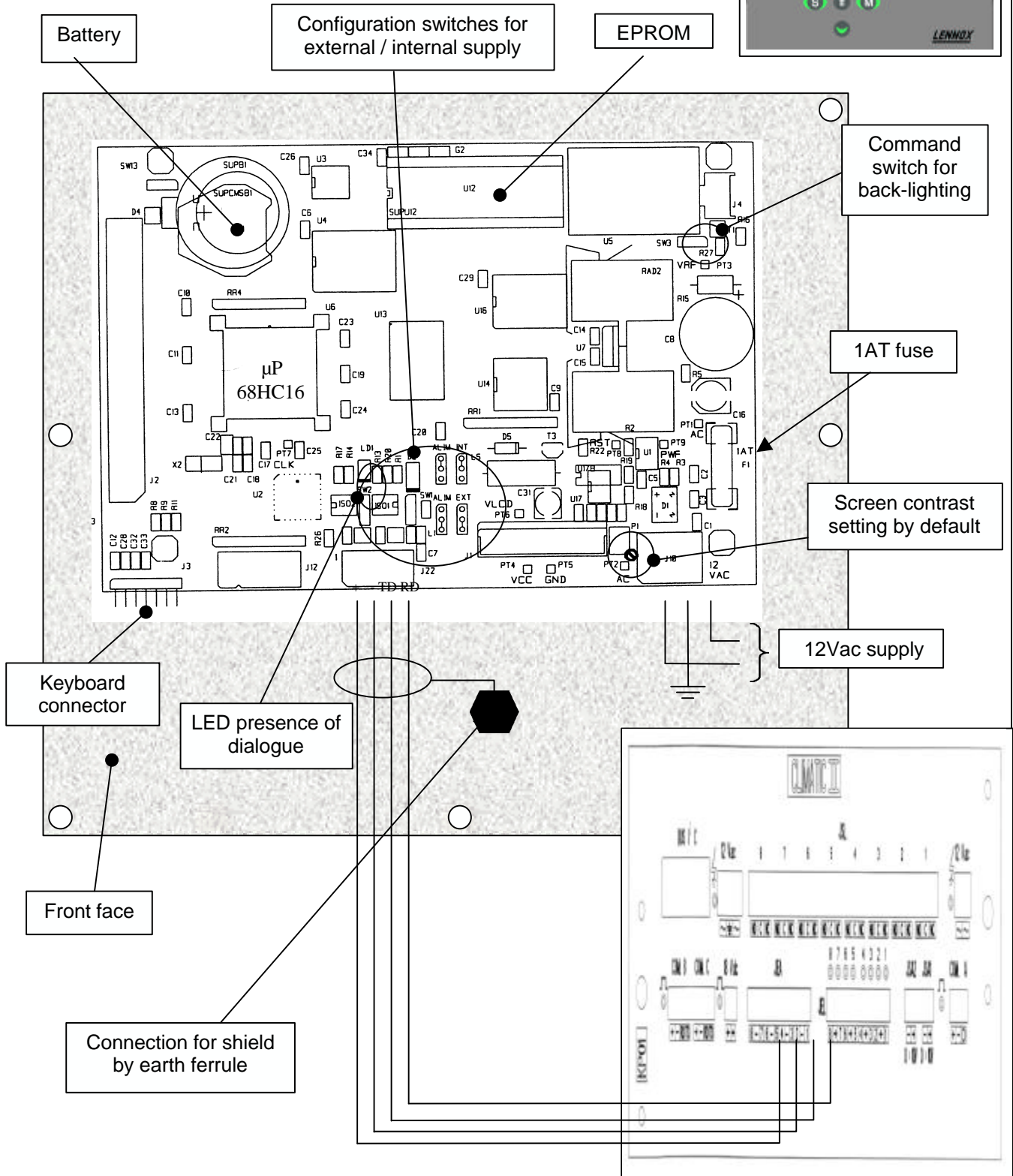
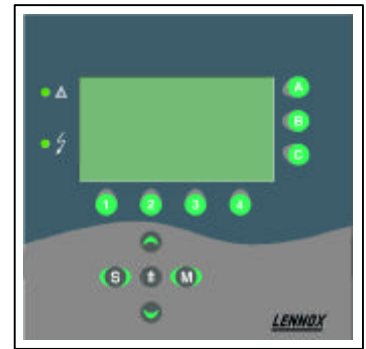

# VDU CONSOLE KP07

## Key :

LD1:	LED presence of dialogue
PT1, PT2:	12Vac
PT3:	Vref
PT4:	Vcc
PT5:	Gnd
PT6:	VLcd
PT8:	Reset
PT9:	Power Fail
SW1, SW2:	Configuration switches internal/external supply
SW3:	On/off switch for back-lighting on display unit

Note : The cable linking the display unit to the main unit must be earthed by means of a ferrule fixed to the front face by the nut provided for this purpose. Since there are joints between the front face and console base, as well as between the base and the door of the electrical cabinet, two bonding straps are required between the latter to ensure a good electrical contact.

## ② Replacement of a VDU console

### Procedure to be followed :

- ☞ Turn off the supply to the card and change the card.
- ☞ Retrieve the EPROM from the old card and fit it to the new one (see drawing below).
- ☞ Reconnect all connections to the KP07, referring to the wiring diagram.

### EPROM positioning :

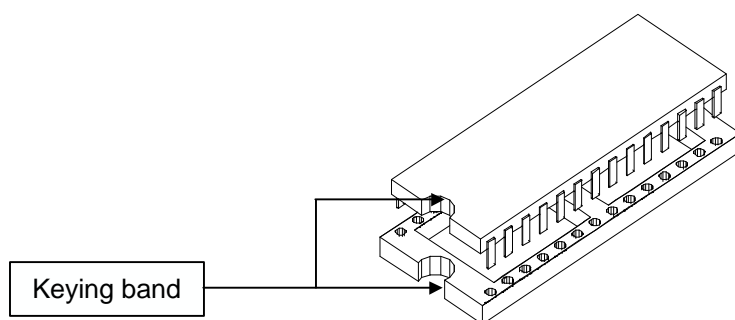



**GREAT BRITAIN ,  
IRELAND :**

**LENNOX INDUSTRIES LTD**

tél. : + 44 1604 599400  
fax : + 44 1604 594200  
e-mail : marketing@lennoxind.com

**BELGIUM :**

**LENNOX BENELUX N.V./S.A.**

tél. : + 32 3 633 30 45  
fax : + 32 3 633 00 89  
e-mail : info@lennoxbenelux.com

**CZECH REPUBLIC :**

**JANKA RADOTIN AS**

tél. : + 420 2 510 88 111  
fax : + 420 2 579 10 393  
e-mail : janka@janka.cz

**FRANCE :**

**LENNOX FRANCE**

tél. : + 33 1 60 17 88 88  
fax : + 33 1 60 17 86 58  
e-mail : accueil@lennoxfrance.com

**GERMANY :**

**LENNOX RUHAAK GmbH**

tél. : + 49 69 42 09790  
fax : + 49 69 42 53 65  
e-mail : info@lennoxdeutschland.com

**NETHERLANDS :**

**LENNOX BENELUX B.V.**

tél. : + 31 33 2471 800  
fax : + 31 33 2459 220  
e-mail : info@lennoxbenelux.com

**POLAND :**

**LENNOX POLSKA SP z o. o.**

tél. : + 48 22 832 26 61  
fax : + 48 22 832 26 62  
e-mail : lennoxpolska@inetia.pl

**PORTUGAL :**

**LENNOX CLIMATIZAÇÃO LDA.**

tél. : +351 2 999 84 60  
fax : +351 2 999 84 68

**RUSSIA :**

**LENNOX DISTRIBUTION MOSCOU**

tél. : + 7 095 246 07 46  
fax : + 7 502 933 29 55  
e-mail : janka\_alex@mtu-net.ru

**SLOVAKIA :**

**LENNOX SLOVAKIA**

tél. : + 421 7 44 88 92 16  
fax : + 421 7 44 88 16 88

**SPAIN :**

**LENNOX REFAC S.A.**

tél. : + 34 902 400 405  
fax : + 34 91 542 84 04  
e-mail : marketing@lennox-refac.com

**UKRAINE :**

**LENNOX DISTRIBUTION KIEV**

tél. : + 380 44 213 14 21  
fax : + 380 44 213 14 21  
e-mail : jankauk@uct.kiev.ua

**OTHER EUROPEAN COUNTRIES,  
AFRICA,  
MIDDLE-EAST :**

**LENNOX DISTRIBUTION**

tél. : + 33 4 72 23 20 00  
fax : + 33 4 72 23 20 28  
e-mail : marketing@lennoxdist.com



**LENNOX**<sup>®</sup>

www.Lennox.com