

1

2

3

4

5

6

7

8

## Document list

Document type	Sheet	Description	Rev.
0 Copertina	1	Document list	
1 Specifiche elettriche	2	Electrical specification	
2 Schema elettrico	3	Power	
2 Schema elettrico	4	Power	
2 Schema elettrico	5	Power	
2 Schema elettrico	6	Power	
2 Schema elettrico	7	Auxiliaries 24V	
2 Schema elettrico	8	Auxiliaries 24V	
2 Schema elettrico	9	Auxiliaries 24V	
2 Schema elettrico	10	Auxiliaries 24V	
2 Schema elettrico	11	Auxiliaries 24V	
2 Schema elettrico	12	Auxiliaries 24V	
2 Schema elettrico	13	Auxiliaries 24V	
2 Schema elettrico	14	Auxiliaries 24V	
2 Schema elettrico	15	Auxiliaries 24V	
2 Schema elettrico	16	Auxiliaries 24V	
3 Layout	17	LAYOUT	
3 Layout	18	LAYOUT	
3 Layout	19	LAYOUT	
3 Layout	20	LAYOUT	
4 Lista componenti	21	COMPONENT LIST	
4 Lista componenti	22	COMPONENT LIST	
4 Lista componenti	23	COMPONENT LIST	
4 Lista componenti	24	COMPONENT LIST	
4 Lista componenti	25	COMPONENT LIST	

## Wire Colour Code

BLACK	Power
RED	AUXILIARY 24V ac
BLUE	AUXILIARY 48V dc
YELLOW/GREEN	Earth

Reference code: /3 .6

Sheet ← → Column

Customer: STD

Order:

Supply: 400 V 50-60 Hz

Auxiliary circuits: 24 V

NOTE 1

NOTE 2

NOTE 3

c		Date	04.07.01	Wiring diagram name		Code	318814	F+C+H	400 Vac	50-60 Hz			
b		Signature	T.A.	318814B							Document list		
a		Contr.	G.G.								0 Copertina		
	Modificat	Date	Norm.	EN60204-1	Replaced for:	Replaced by:	Origin:	TYPE:	HIMOD 55-85C	File:	318814B	Sheet 1 of 24	Continue

1

2

3

4

5

6

7

8

A

## Electrical specification-Elektrische Angaben-Specifiche elettriche

B

A)FAN 1-2  
VENTILATOR 1-2  
VENTILATORE 1-2

Un 400 3-50Hz  
No.2 Pa 2,3kW  
Ia 4,3A 1260rpm cosf=0,85

C

C) ELECTRIC HEATING  
ELEKTROHEIZUNG  
RISCALDAMENTO ELETTRICO

3 STEPS - 3 GRADINI - 3 STUFEN  
Pn 11,7 kW Un 400V 3-50Hz

D

D) HUMIDIFIER  
BEFEUCHTER  
UMIDIFICATORE

Un 400V 3-  
1)-STEAM PRODUCTION  
PRODUZ. VAPORE  
DAMPFMENGE

HUMIDAIR  
9kg/h Pn 6,8kW

## SUPPLY LINE-SPANNUNGSVERSORGUNG-LINEA ALIMENTAZIONE

3-PHASE + NEUTRAL + GROUND (PE)  
3-PHASE + NULLEITER + ERDUNG (PE)  
3-FASE + NEUTRO + TERRA (PE)

400V 3N-50Hz

		Imax:55-65-60-85U/0
A		9,5A
A+C		18,5A
A+D		20A

E

F

THIS DIAGRAM IS CARRIED OUT ACCORDING TO EUROPEAN STD EN60204-1-2

c		Date	04.07.01	Wiring diagram name			Code	318814	F+C+H	400 Vac 50-60 Hz	Electrical specification
b		Signature	G.A.	318814B							
a		Contr.	G.G.								
Modification	Date	Date	Norm.	EN60204-1	Replaced for:	Replaced by:	Origin:		HIMOD 55-85C	File: 318814B	1 Specifiche elettriche Sheet 2 of 24 Continue

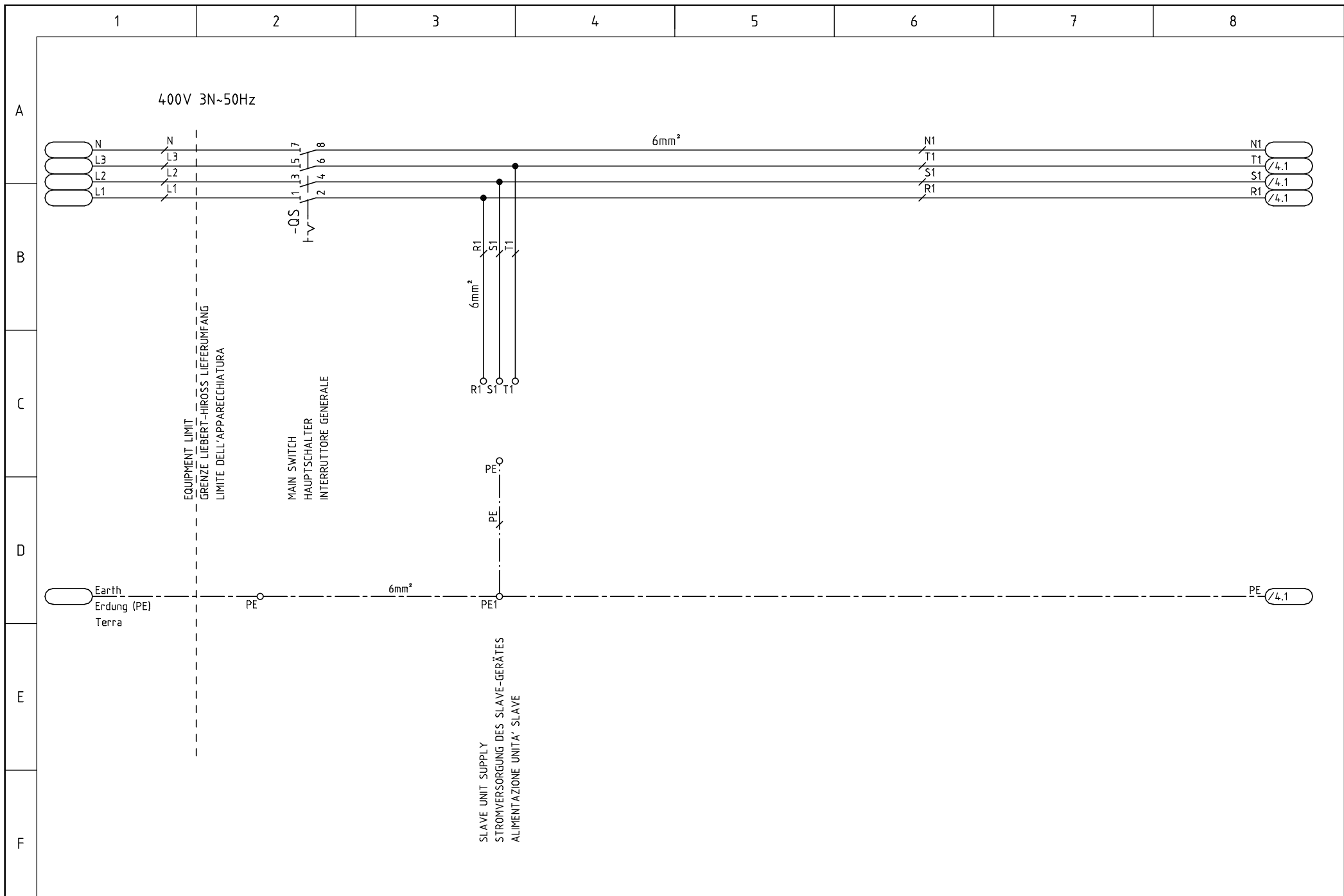

c		Date	04.07.01	Wiring diagram name			Code	F+C+H	400 Vac 50-60 Hz	Power
b		Signature	E.A.	318814B			318814			
a		Contr.	G.G.					TYPE: HIMOD 55-85C	2 Schema elettrico	Sheet 3 of 24
	Modification	Date	Norm.	Replaced for:	Replaced by:	Origin:		File: 318814B		Continue 4
			EN60204-1							

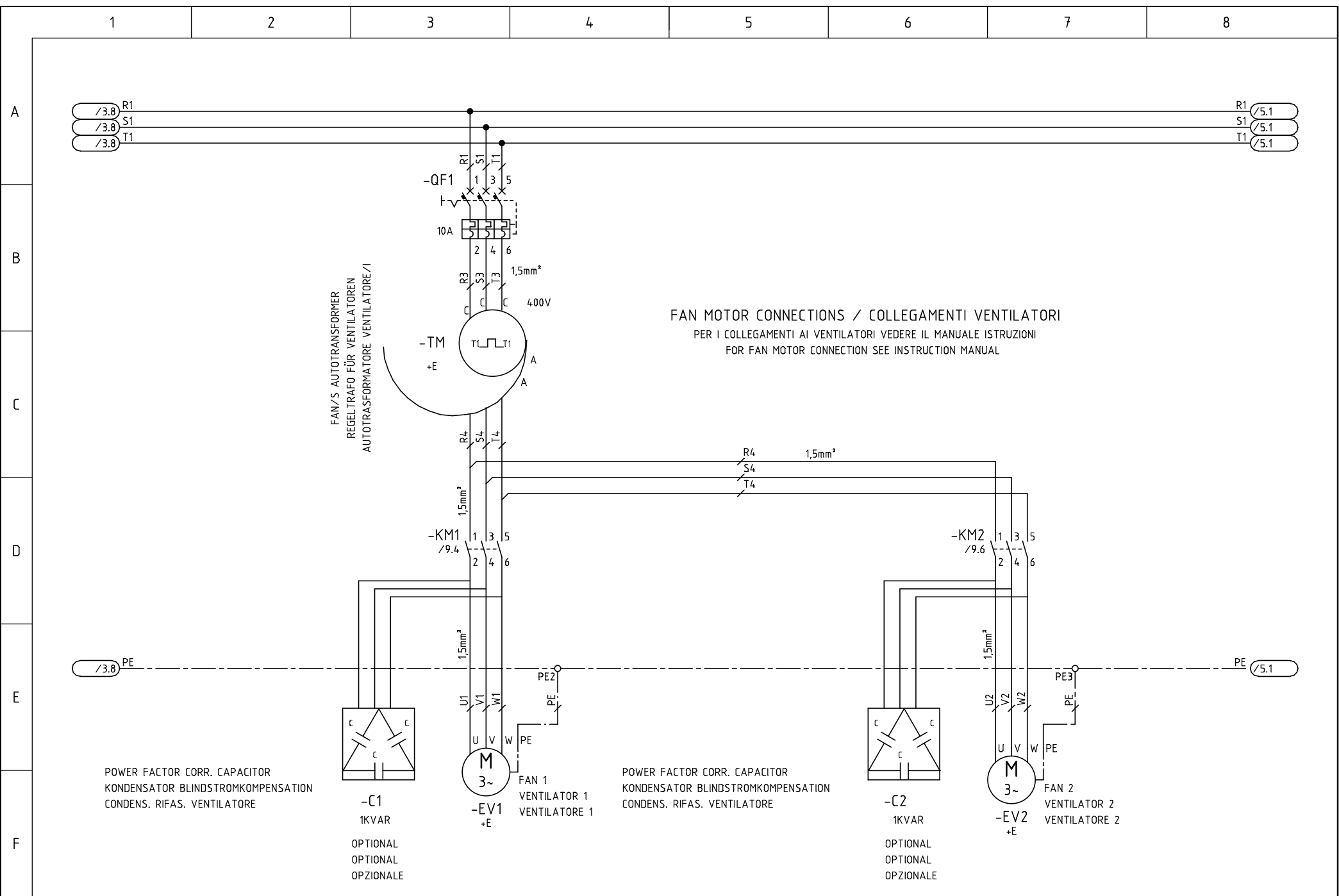

c		Date	04.07.01	Wiring diagram name	318814B	Code	318814	F+C+H	400 Vac 50-60 Hz	
b		Signature	E.A.							Power
a		Contr.	G.G.							2 Schema elettrico
Modification	Date	Date	Norm.	EN60204-1	Replaced for:	Replaced by:	Origin:	HIMOD 55-85C	File: 318814B	Sheet 4 of 24 Continue 5

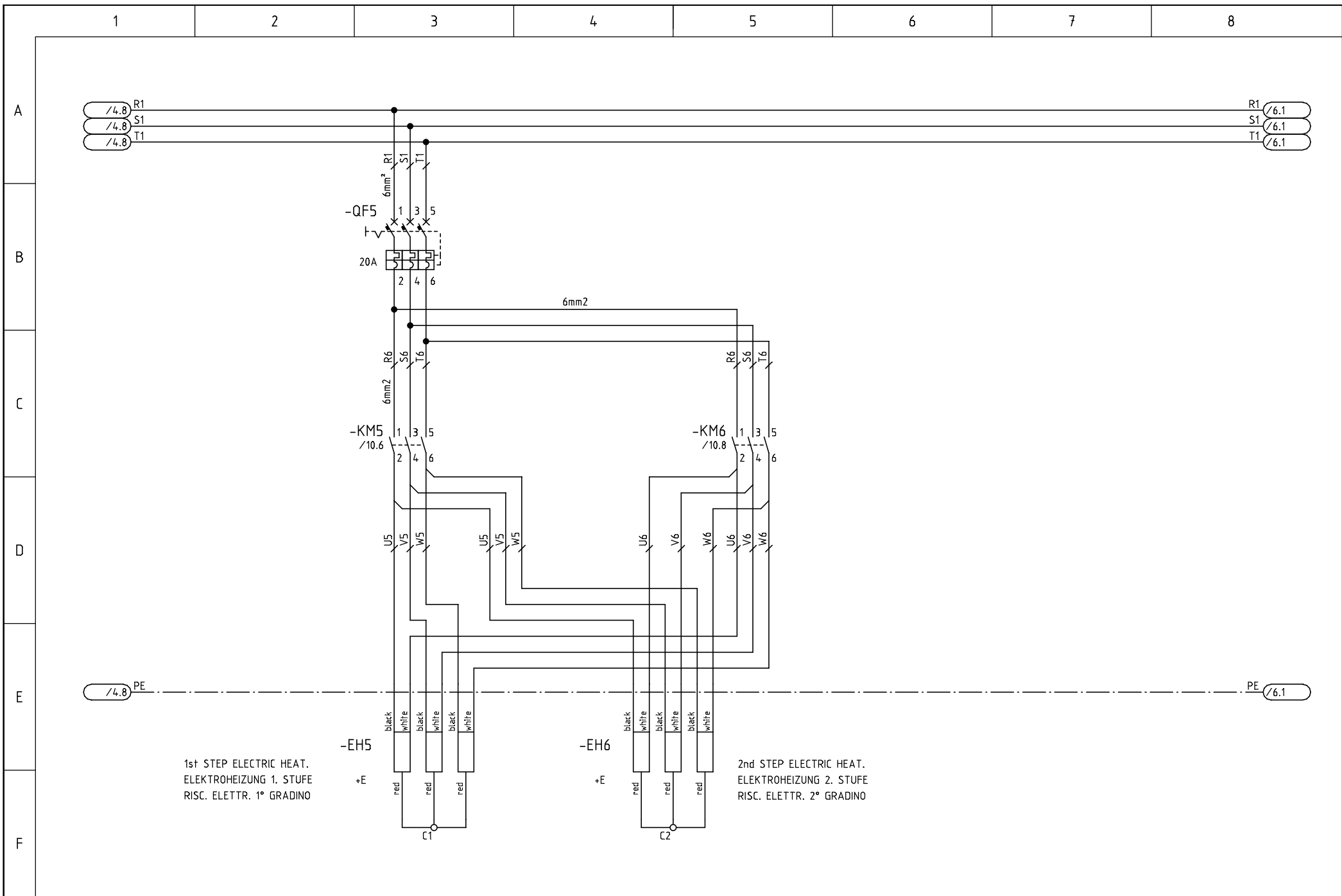

c		Date	04.07.01	Wiring diagram name			Code	F+C+H	400 Vac 50-60 Hz	Power			
b		Signature	F.A.	318814B			318814						
a		Contr.	G.G.										
Modification	Date	Date	Norm.	EN60204-1	Replaced for:	Replaced by:	Origin:	TYPE:	HIMOD 55-85C	File: 318814B	2 Schema elettrico	Sheet 5 of 24	Continue 6

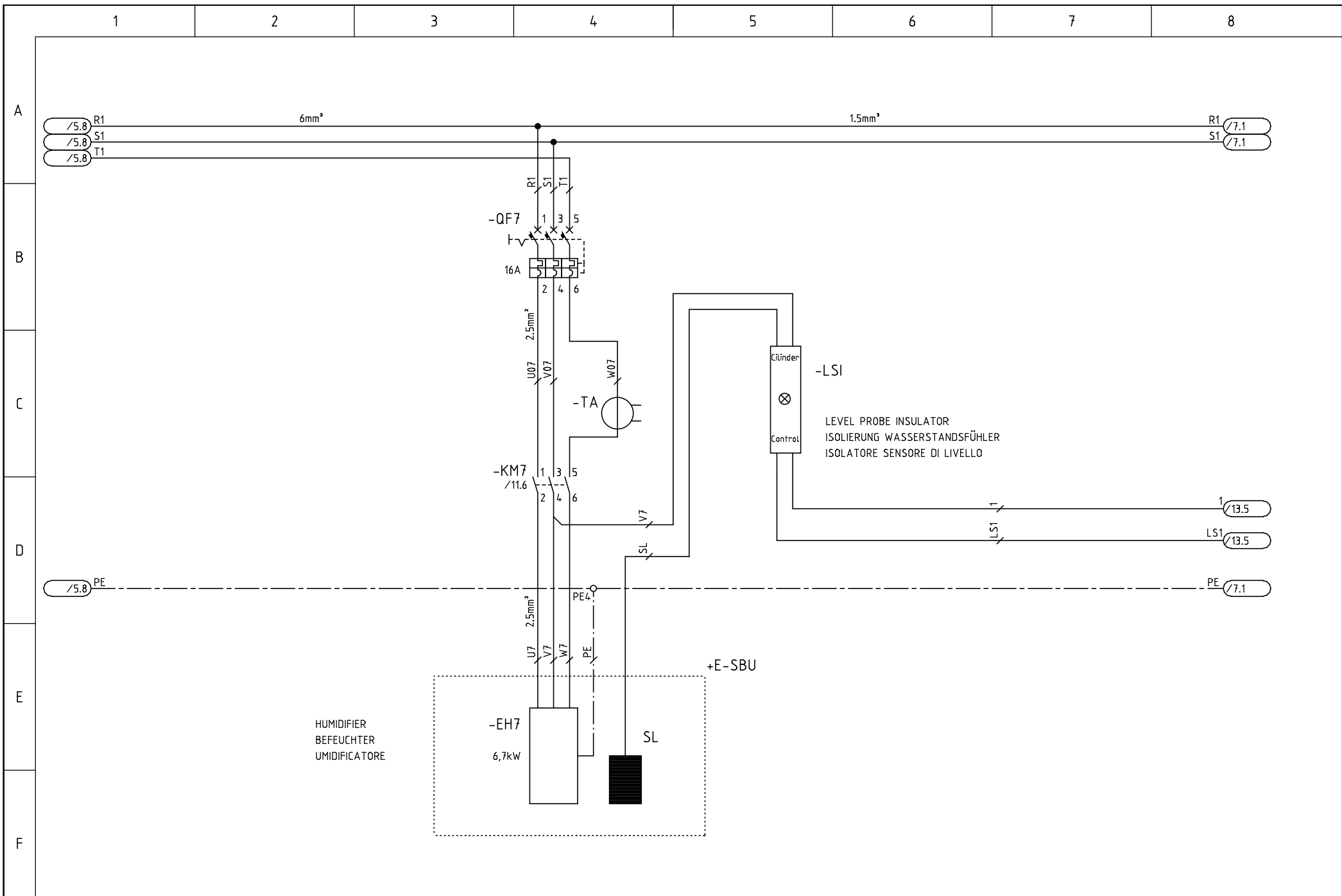

c		Date	04.07.01	Wiring diagram name			Code	F+C+H	400 Vac	50-60 Hz		
b		Signature	E.A.	318814B			318814				Power	
a		Contr.	G.G.					TYPE:			2 Schema elettrico	
	Modification	Date	Norm.	EN60204-1	Replaced for:	Replaced by:	Origin:	HIMOD 55-85C	File:	318814B	Sheet 6 of 24	Continue 7

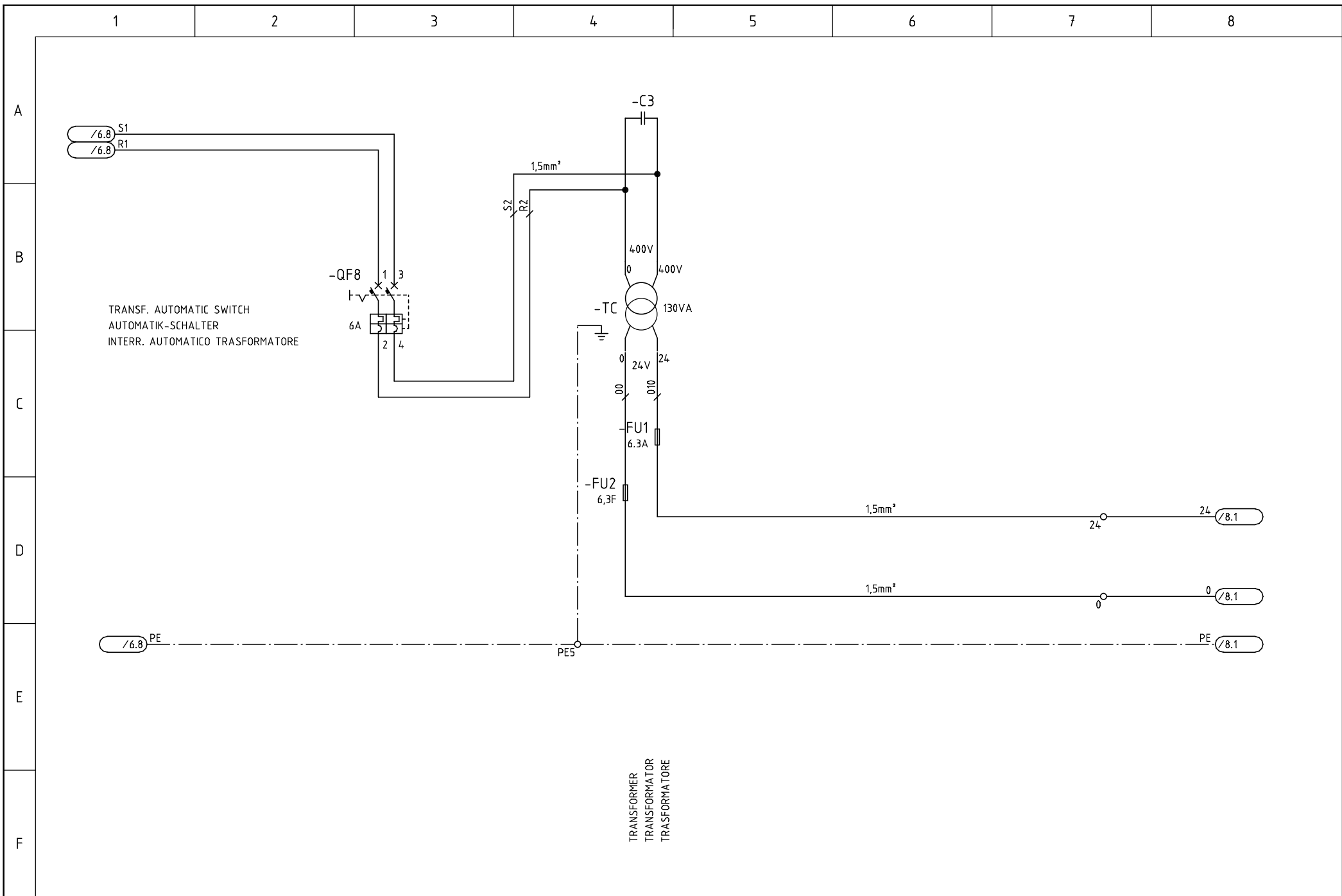

c		Date	04.07.01	Wiring diagram name			Code	318814	F+C+H	400 Vac	50-60 Hz		
b		Signature	F.A.	318814B								Auxiliaries 24V	
a		Contr.	G.G.						TYPE:	HIMOD 55-85C	File: 318814B	2 Schema elettrico	
	Modification	Date	Date	Norm.	EN60204-1	Replaced for:	Replaced by:	Origin:				Sheet 7 of 24	Continue 8

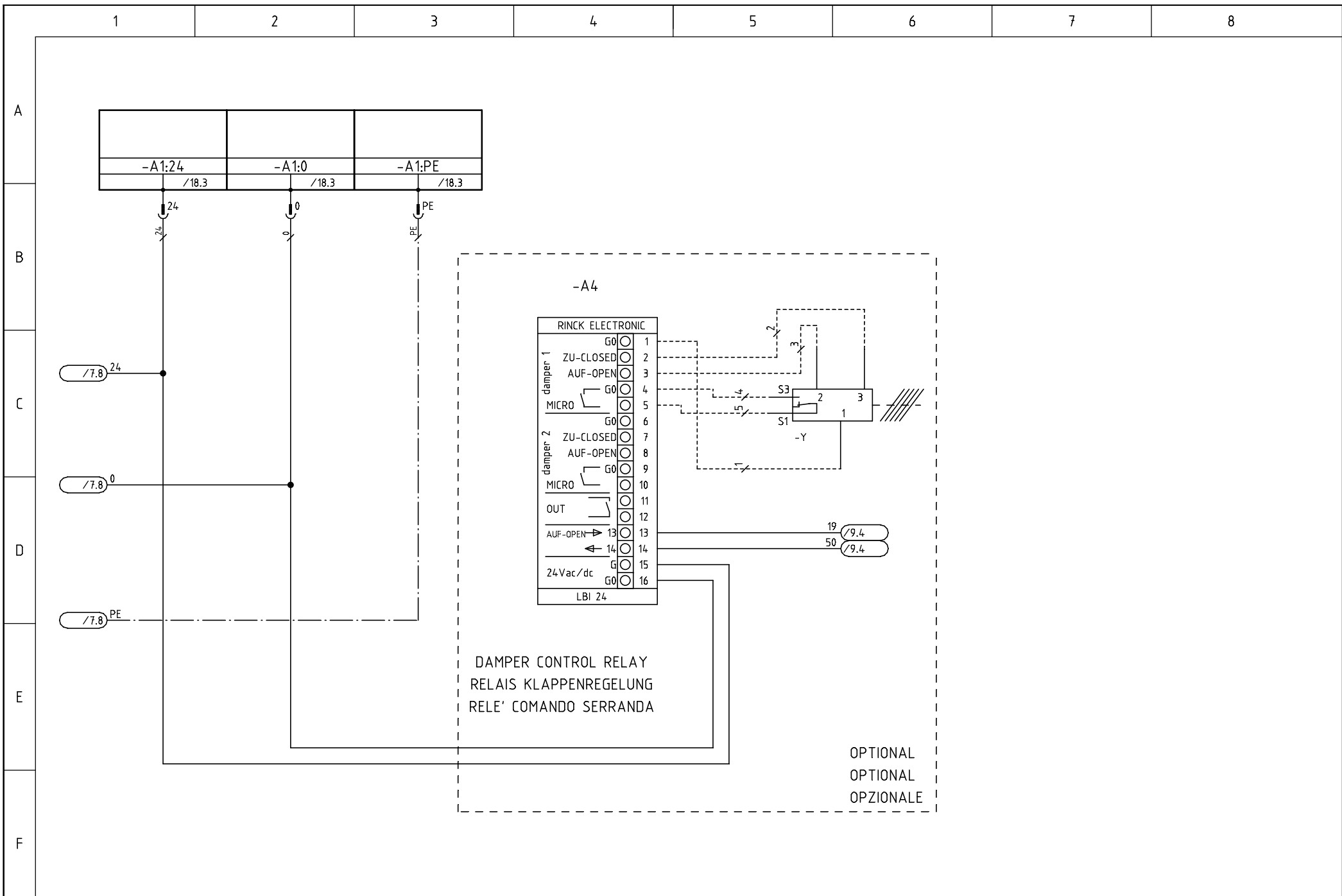

DAMPER CONTROL RELAY  
 RELAI KLAPPENREGELUNG  
 RELE' COMANDO SERRANDA

OPTIONAL  
 OPTIONAL  
 OPZIONALE

c		Date	04.07.01	Wiring diagram name			Code	F+C+H	400 Vac 50-60 Hz	Auxiliaries 24V
b		Signature	F.A.	318814B			318814			
a		Contr.	G.G.							
Modification	Date	Date	Norm.	EN60204-1	Replaced for:	Replaced by:	Origin:	HIMOD 55-85C	File: 318814B	2 Schema elettrico Sheet 8 of 24 Continue 9



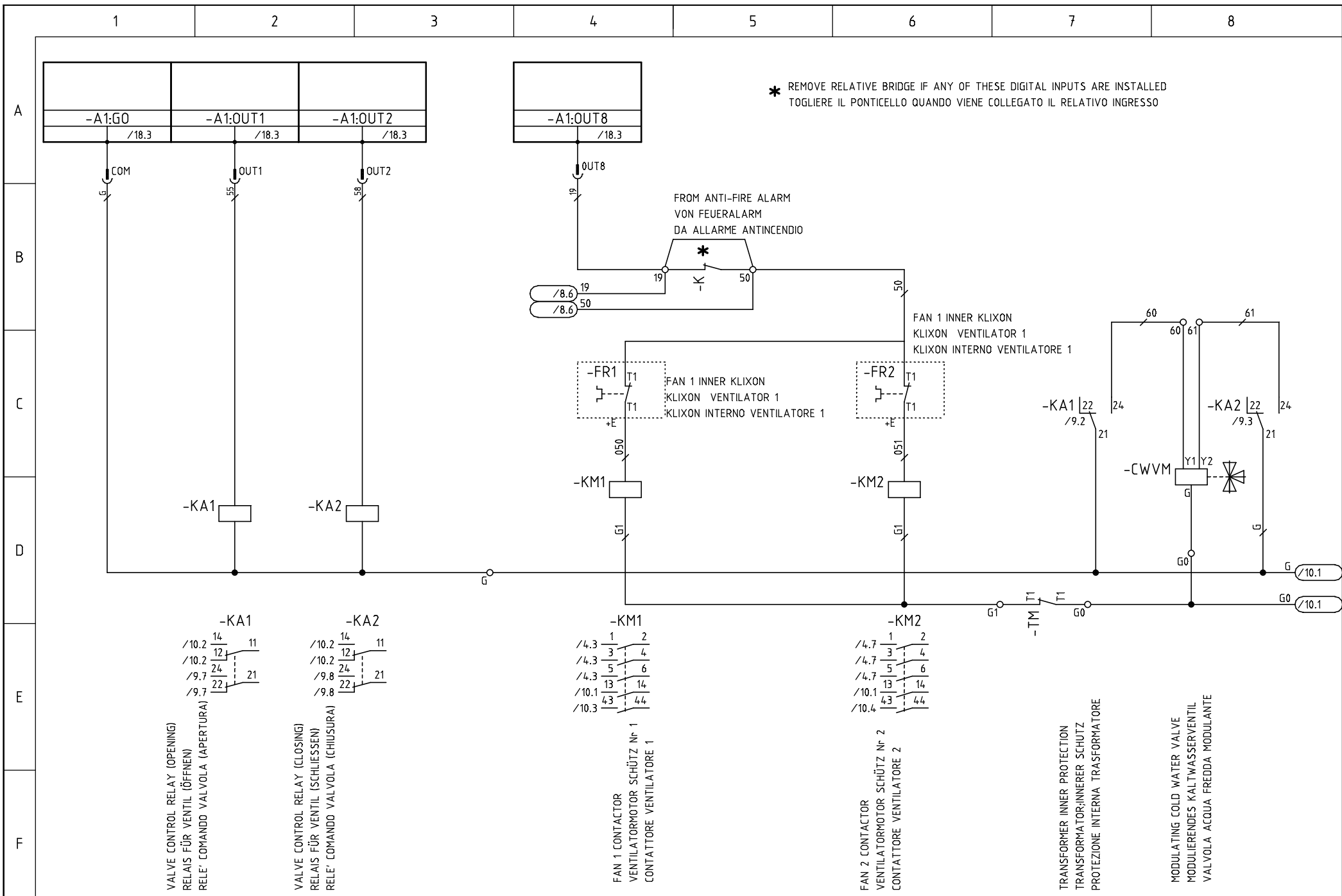

c	Date	04.07.01	Wiring diagram name			Code	F+C+H	400 Vac 50-60 Hz	Auxiliaries 24V
b	Signature	E.A.	318814B			318814			
a	Contr.	G.G.					TYPE: HIMOD 55-85C	File: 318814B	2 Schema elettrico
Modification	Date	Date	Norm.	EN60204-1	Replaced for:	Replaced by:	Origin:	Sheet 9 of 24	Continue 10

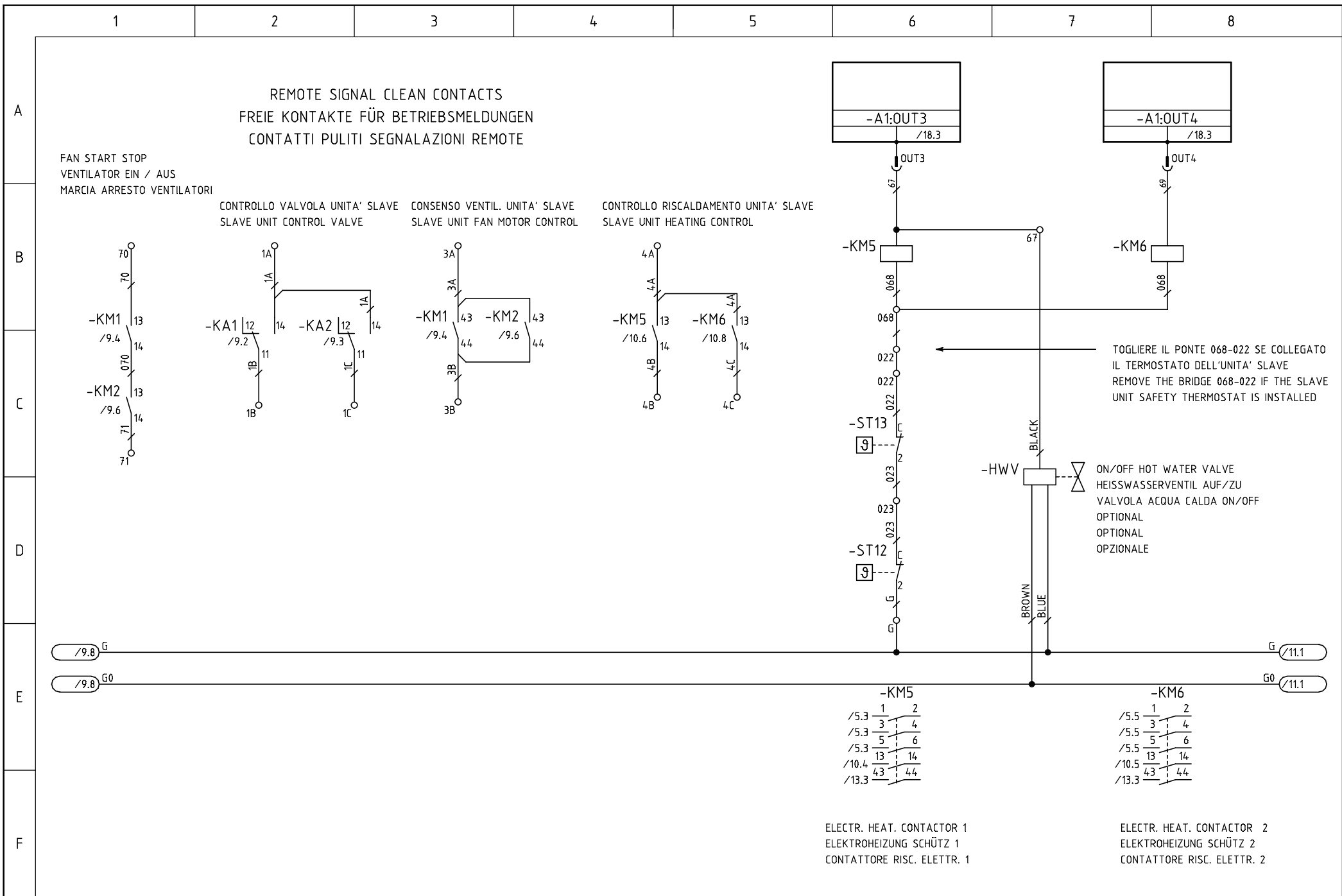

c		Date	04.07.01	Wiring diagram name	318814B	Code	318814	F+C+H	400 Vac 50-60 Hz	Auxiliaries 24V
b		Signature	F.A.					TYPE:	HIMOD 55-85C	2 Schema elettrico
a		Contr.	G.G.					File:	318814B	Sheet 10 of 24
	Modification	Date	Date	Norm.	EN60204-1	Replaced for:	Replaced by:	Origin:		Continue 11

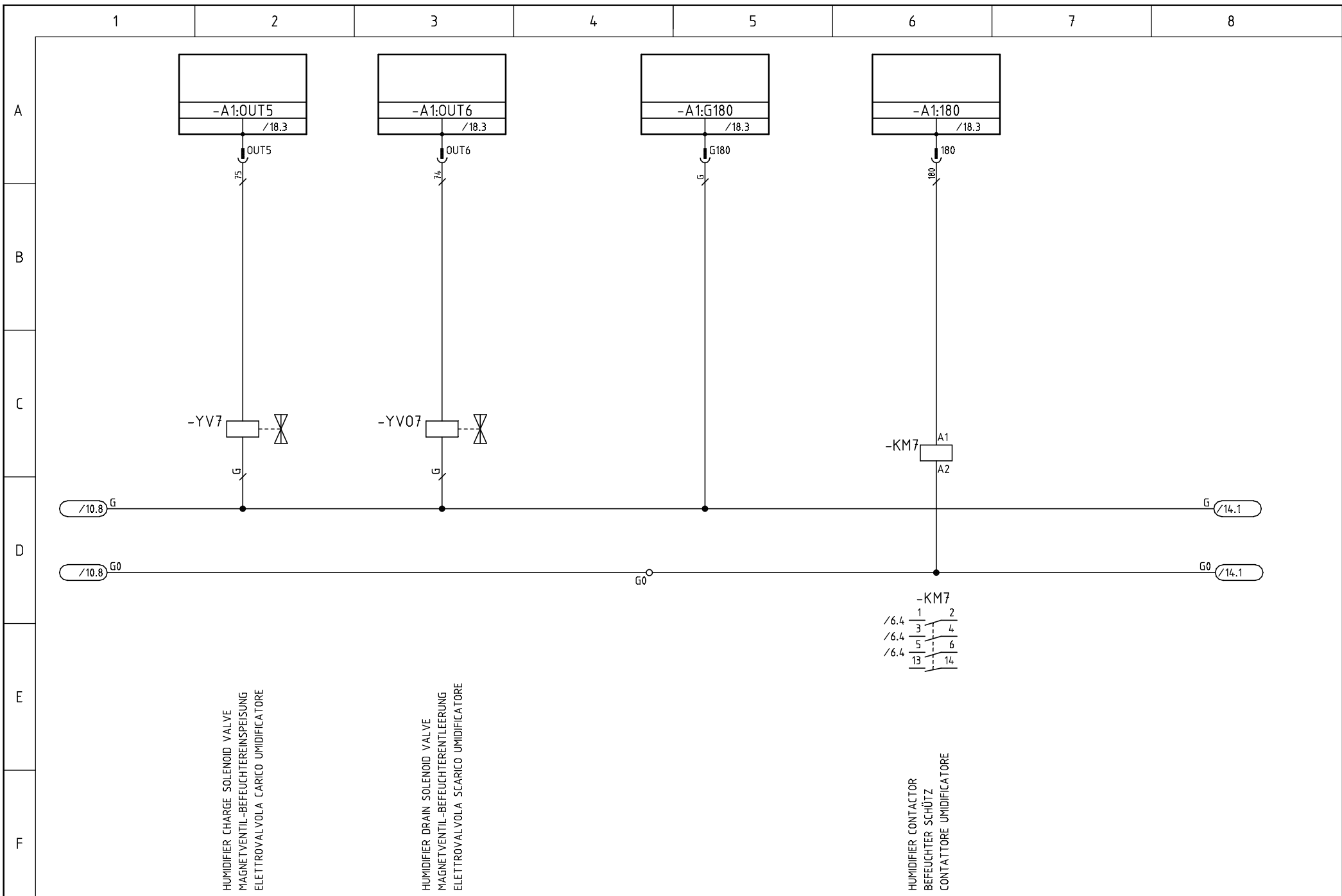

HUMIDIFIER CHARGE SOLENOID VALVE  
 MAGNETVENTIL-BEFEUCHTEREINSPEISUNG  
 ELETTROVALVOLA CARICO UMIDIFICATORE

HUMIDIFIER DRAIN SOLENOID VALVE  
 MAGNETVENTIL-BEFEUCHTERENTLEERUNG  
 ELETTROVALVOLA SCARICO UMIDIFICATORE

HUMIDIFIER CONTACTOR  
 BEFEUCHTER SCHÜTZ  
 CONTATTATORE UMIDIFICATORE

c		Date	04.07.01	Wiring diagram name			Code	F+C+H	400 Vac 50-60 Hz	Auxiliaries 24V
b		Signature	E.A.	318814B			318814			
a		Contr.	G.G.							
Modification	Date	Date	Norm.	EN60204-1	Replaced for:	Replaced by:	Origin:	HIMOD 55-85C	File: 318814B	2 Schema elettrico Sheet 11 of 24 Continue 12

1

2

3

4

5

6

7

8

\* REMOVE RELATIVE BRIDGE IF ANY OF THESE DIGITAL INPUTS ARE INSTALLED  
TOGLIERE IL PONTICELLO QUANDO VIENE COLLEGATO IL RELATIVO INGRESSO

A

B

C

D

E

F

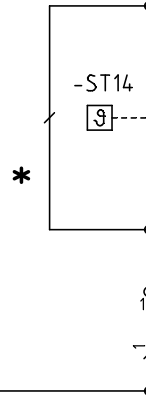
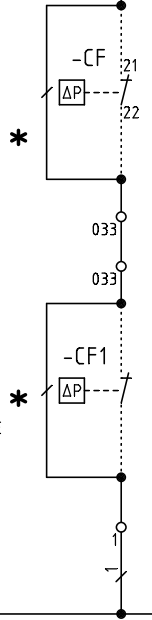
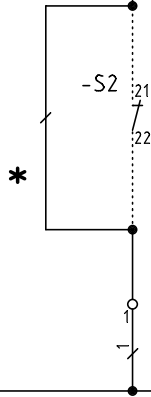
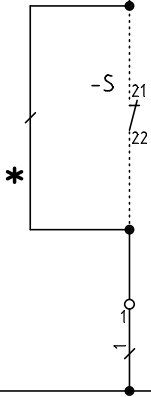
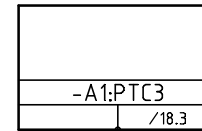
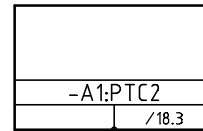
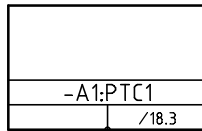
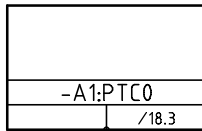
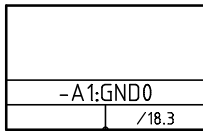

CF1 INSTALLED ON SLAVE UNIT  
CF1 IN SLAVE GERÄT EINGEBAUT  
CF1 INSTALLATO SU UNITA' SLAVE

1 /13.1

REMOTE ON/OFF  
EXTERN EIN-AUS  
ON/OFF REMOTO

USER 1 INPUT  
BENUTZERENGANG 1  
INGRESSO UTENTE 1

CLOGGED FILTER ALARM  
FILTERWARNDUNG  
ALLARME FILTRI SPORCHI  
OPTIONAL  
OPZIONALE

WATER HIGH TEMPERATURE TSTAT  
WASSERTEMPORATUR ZU HOCH  
T-STATO ALTA TEMP. ACQUA  
OPTIONAL  
OPZIONALE

c		Date	04.07.01	Wiring diagram name			Code	F+C+H	400 Vac 50-60 Hz	Auxiliaries 24V
b		Signature	E.A.	318814B			318814			
a		Contr.	G.G.					TYPE: HIMOD 55-85C	File: 318814B	2 Schema elettrico
Modification	Date	Date	Norm.	EN60204-1	Replaced for:	Replaced by:	Origin:			Sheet 12 of 24 Continue 13

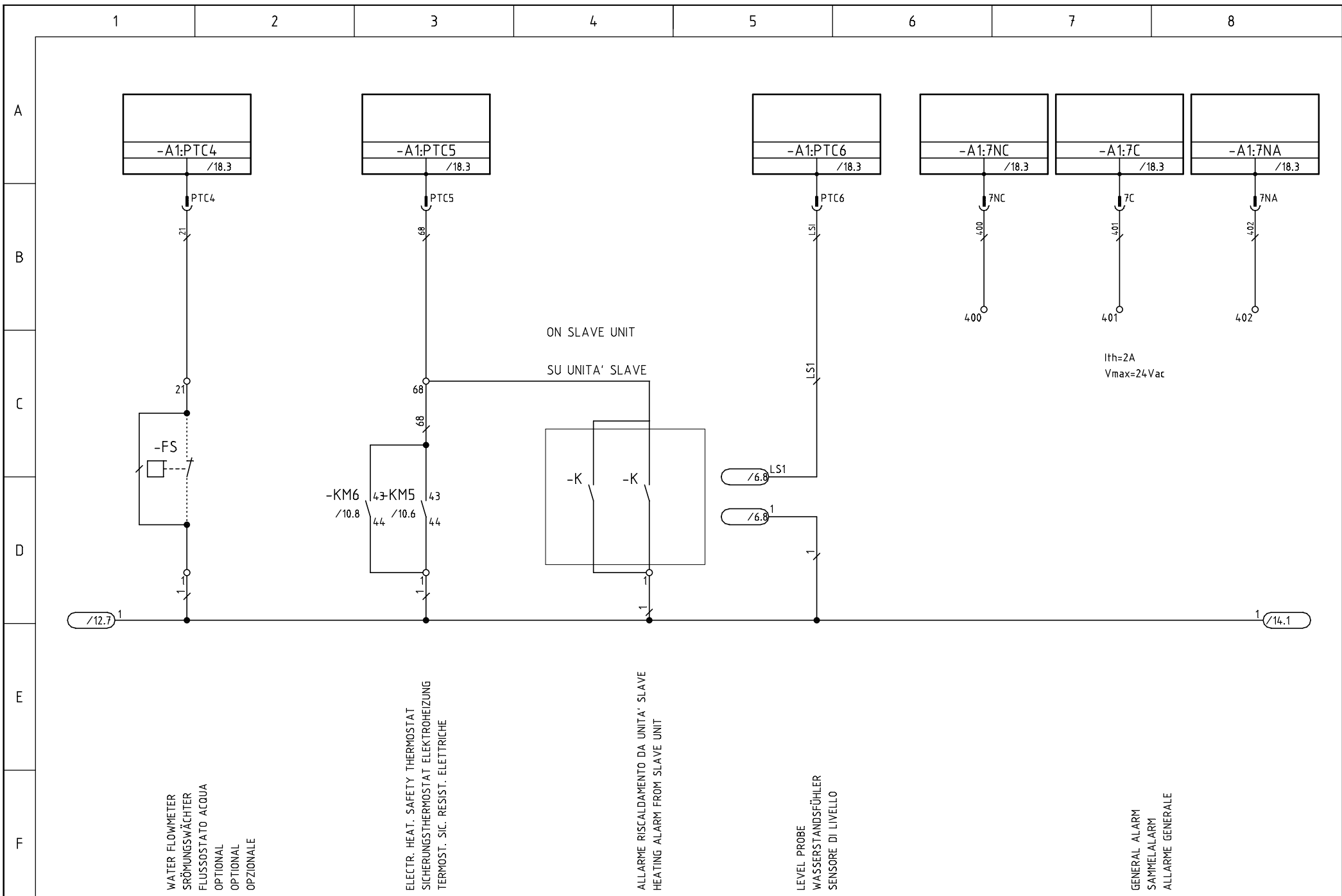

c	Date	04.07.01	Wiring diagram name			Code	F+C+H	400 Vac 50-60 Hz	Auxiliaries 24V
b	Signature	E.A.	318814B			318814			
a	Contr.	G.G.					TYPE:	HIMOD 55-85C	2 Schema elettrico
Modification	Date	Date	Norm.	EN60204-1	Replaced for:	Replaced by:	Origin:	File: 318814B	Sheet 13 of 24 Continue 14

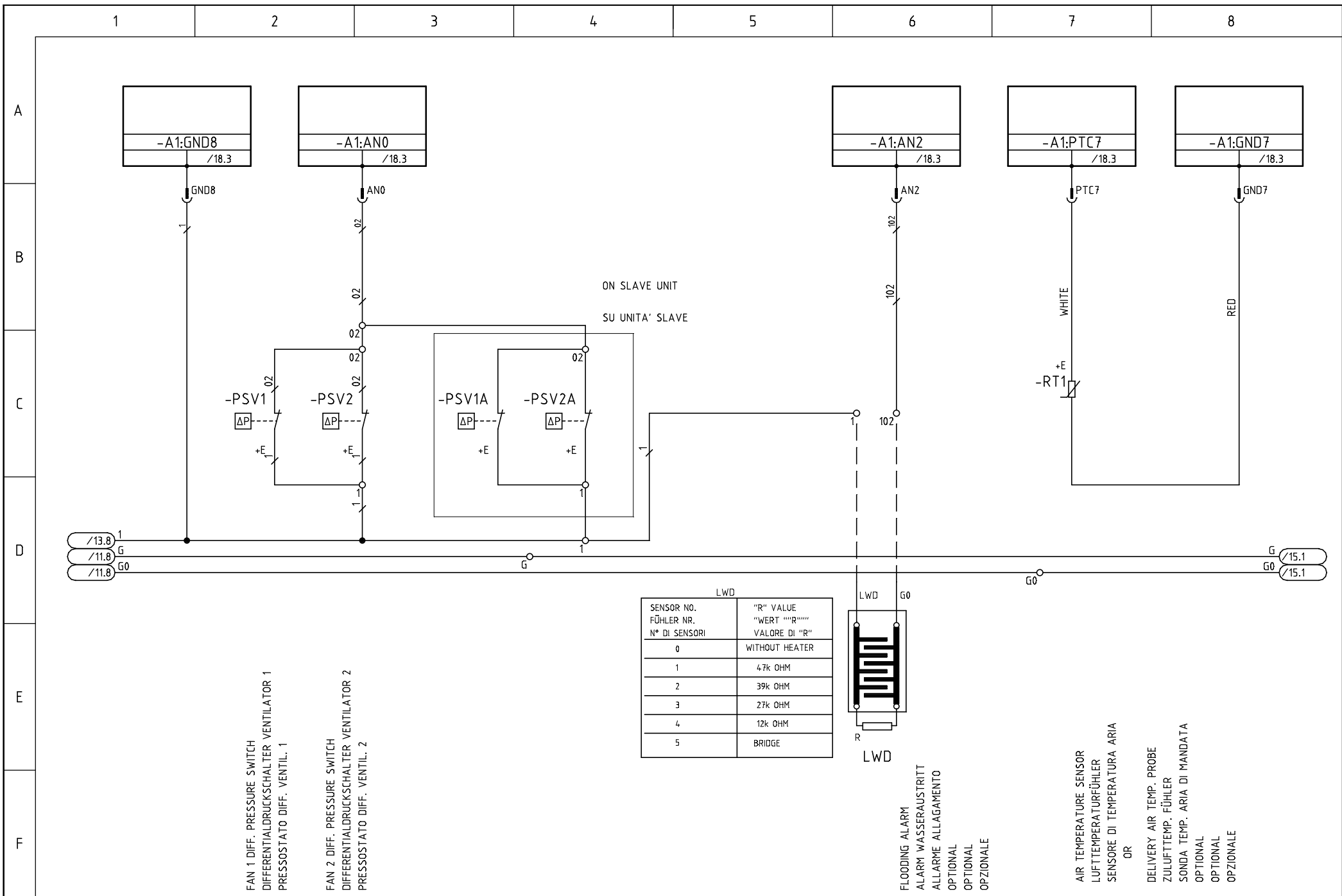

c		Date	04.07.01	Wiring diagram name			Code	F+C+H	400 Vac	50-60 Hz	Auxiliaries 24V			
b		Signature	E.A.	318814B			318814							
a		Contr.	G.G.											
Modification	Date	Date	Norm.	EN60204-1	Replaced for:	Replaced by:	Origin:	TYPE:	HIMOD 55-85C	File:	318814B	2 Schema elettrico	Sheet 14 of 24	Continue 15

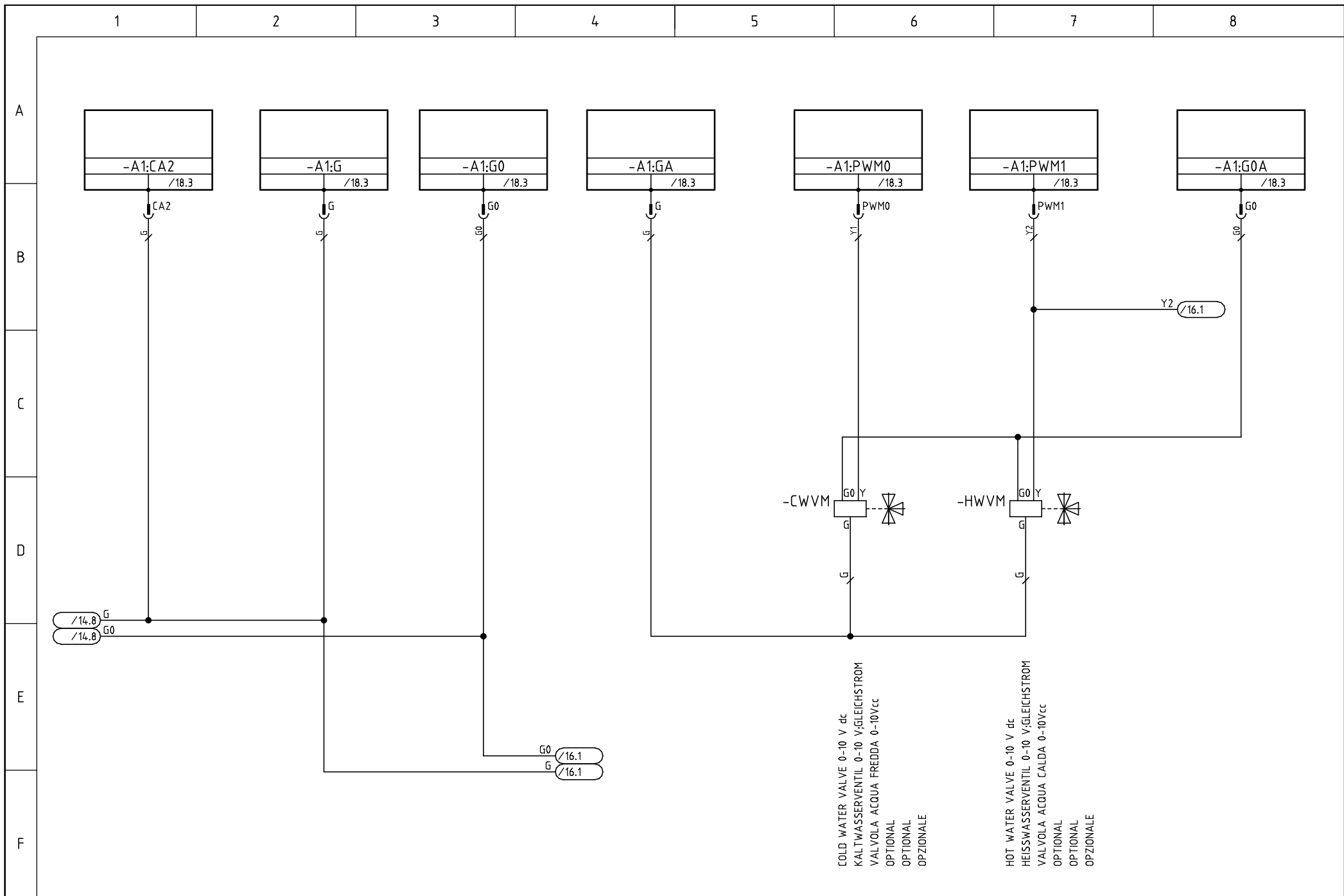

COLD WATER VALVE 0-10 V dc  
 KALTWASSERVENTIL 0-10 V GLEICHSTROM  
 VALVOLA ACQUA FREDDA 0-10Vcc  
 OPTIONAL  
 OPZIONALE

HOT WATER VALVE 0-10 V dc  
 HEISSWASSERVENTIL 0-10 V GLEICHSTROM  
 VALVOLA ACQUA CALDA 0-10Vcc  
 OPTIONAL  
 OPZIONALE

c		Date	04.07.01	Wiring diagram name			Code	318814	F+C+H	400 Vac 50-60 Hz	Auxiliaries 24V
b		Signature	F.A.	318814B							
a		Contr.	G.G.								
	Modification	Date	Norm.	EN60204-1	Replaced for:	Replaced by:	Origin:	TYPE:	HIMOD 55-85C	File:	318814B
											2 Schema elettrico
											Sheet 15 of 24
											Continue 16

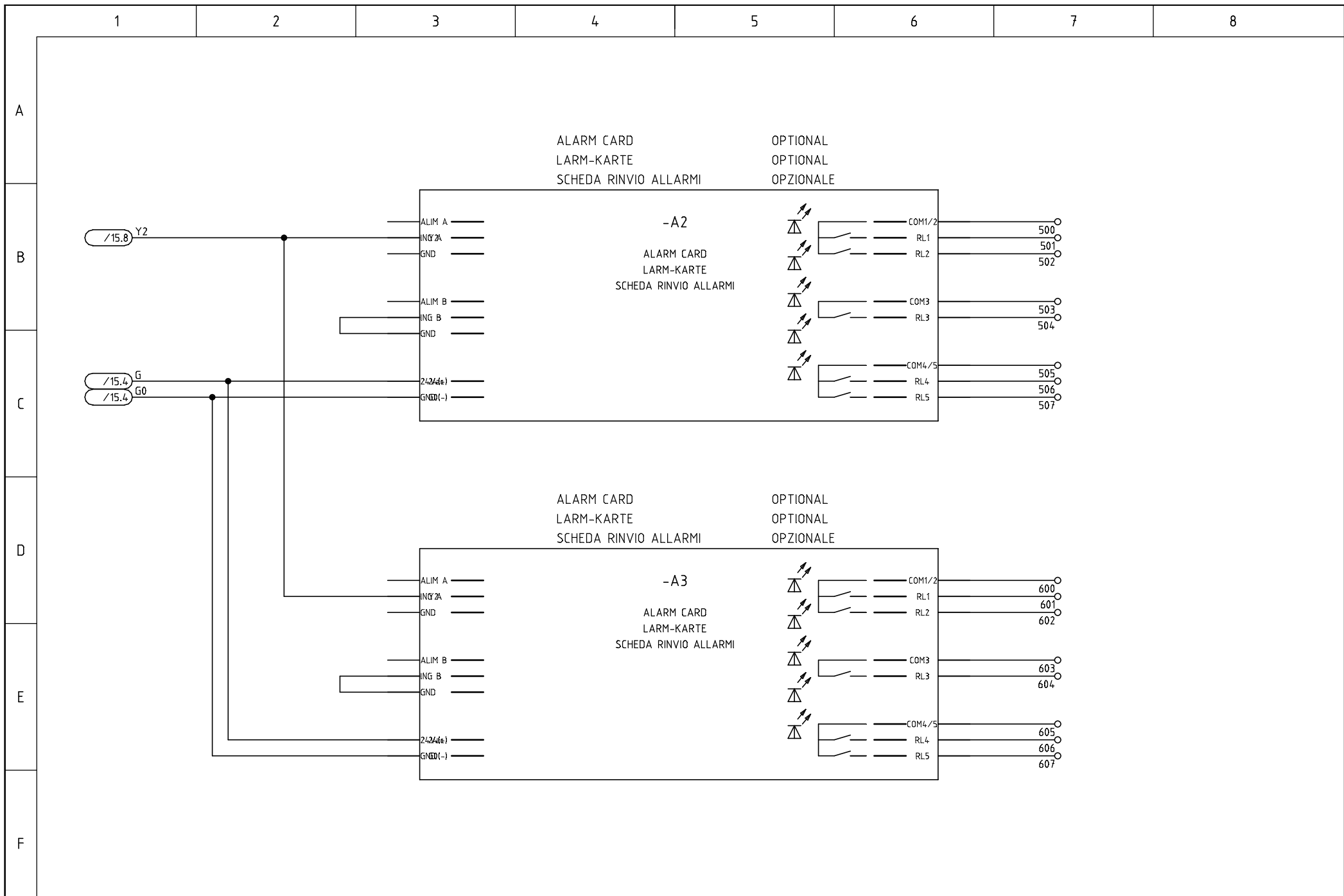

c			Date	04.07.01	Wiring diagram name			Code	F+C+H	400 Vac 50-60 Hz	Auxiliaries 24V	
b			Signature	F.A.	318814B			318814				
a			Contr.	G.G.					TYPE:	HIMOD 55-85C	2 Schema elettrico	
	Modification	Date	Date	Norm.	EN60204-1	Replaced for:	Replaced by:	Origin:	File:	318814B	Sheet 16 of 24	Continue



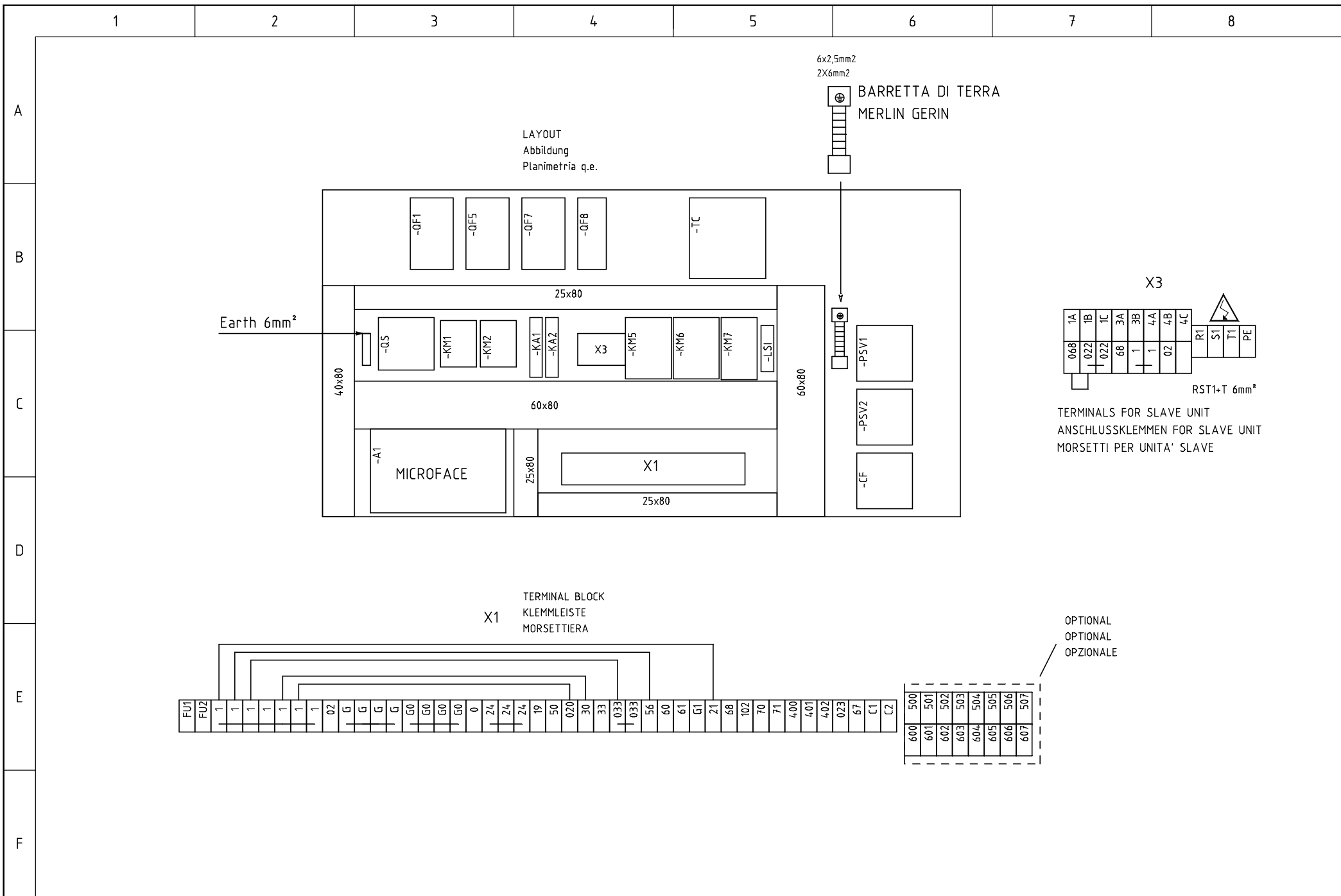

c		Date	04.07.01	Wiring diagram name			Code	F+C+H	400 Vac 50-60 Hz	LAYOUT
b		Signature	E.A.	318814B			318814			
a		Contr.	G.G.					TYPE:	HIMOD 55-85C	3 Layout
Modification	Date	Date	Norm.	EN60204-1	Replaced for:	Replaced by:	Origin:	File:	318814B	Sheet 17 of 24 Continue 18

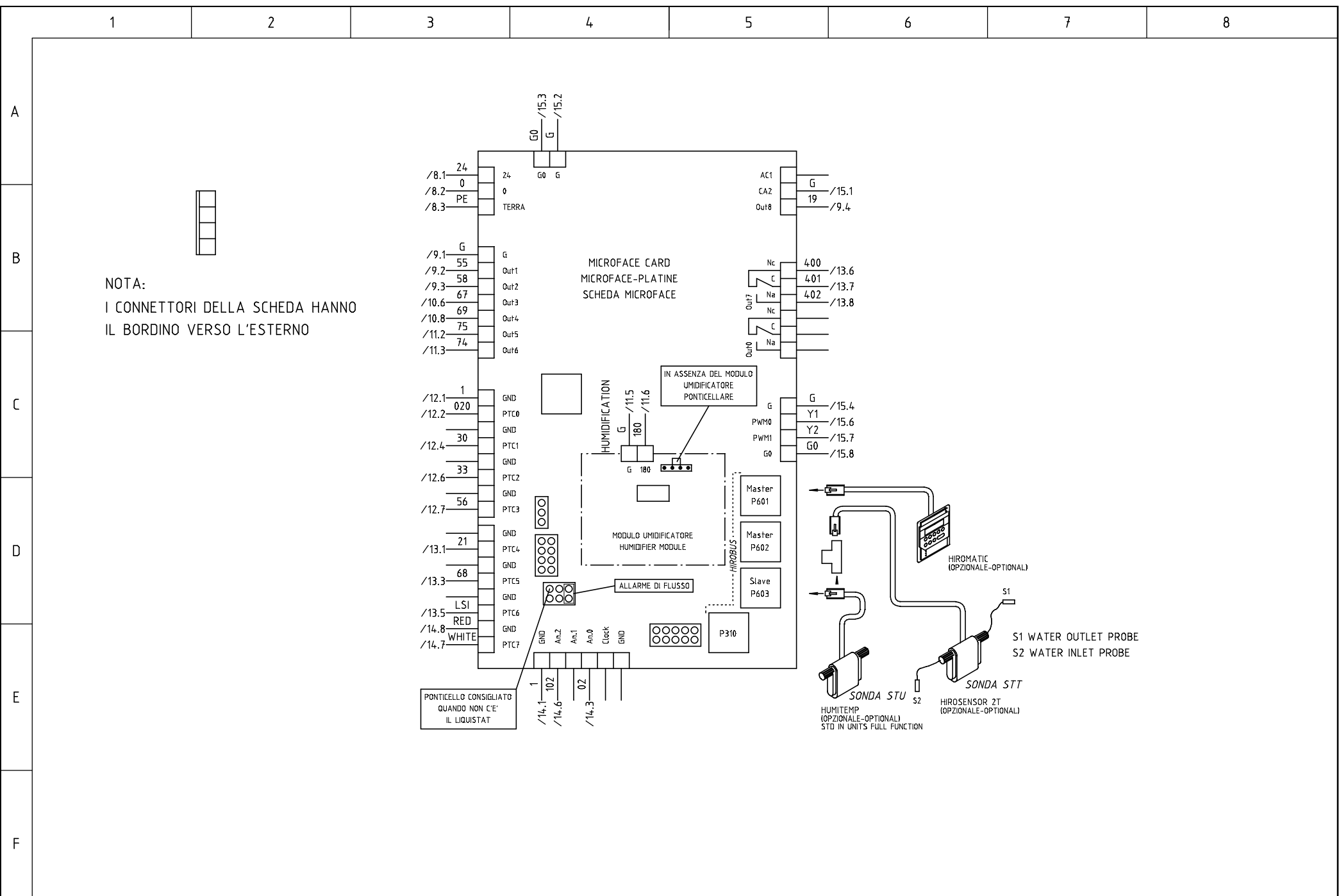

NOTA:  
I CONNETTORI DELLA SCHEDA HANNO  
IL BORDINO VERSO L'ESTERNO

c		Date	04.07.01	Wiring diagram name			Code	F+C+H	400 Vac 50-60 Hz	LAYOUT
b		Signature	F.A.	318814B			318814			
a		Contr.	G.G.					TYPE:	HIMOD 55-85C	3 Layout
Modification	Date	Date	Norm.	EN60204-1	Replaced for:	Replaced by:	Origin:	File:	318814B	Sheet 18 of 24 Continue 19

1

2

3

4

5

6

7

8

A

B

C

D

E

F

LCD DISPLAY REAR BACK VIEW

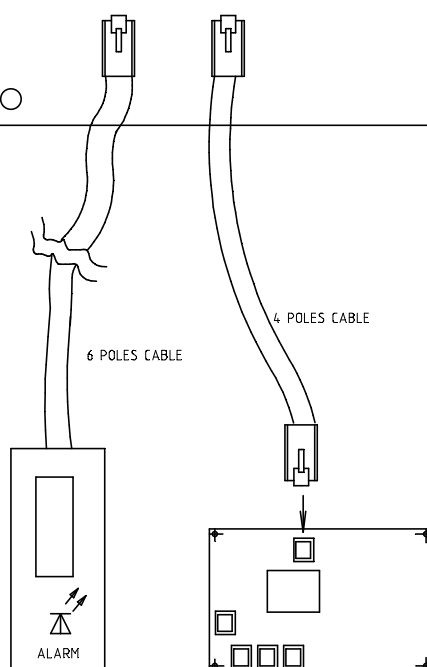
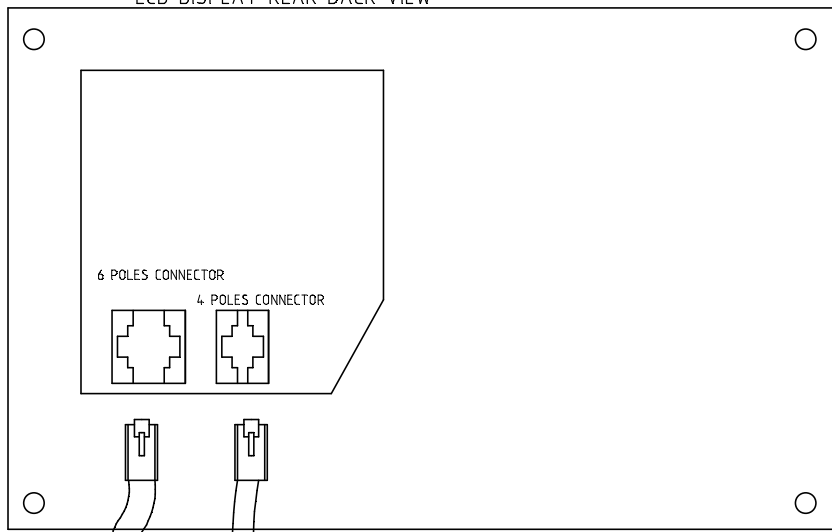

ON-OFF PANEL	
LED COLOR	AIR COND. UNIT STATUS
GREEN ON	UNIT OPERATING
RED ON	UNIT IN ALARM
GREEN FLASHING	UNIT IN STAND-BY
ORANGE ON	UNIT POWERED BUT NOT OPERATING

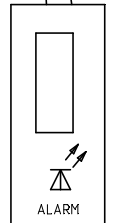

ON-OFF PANEL

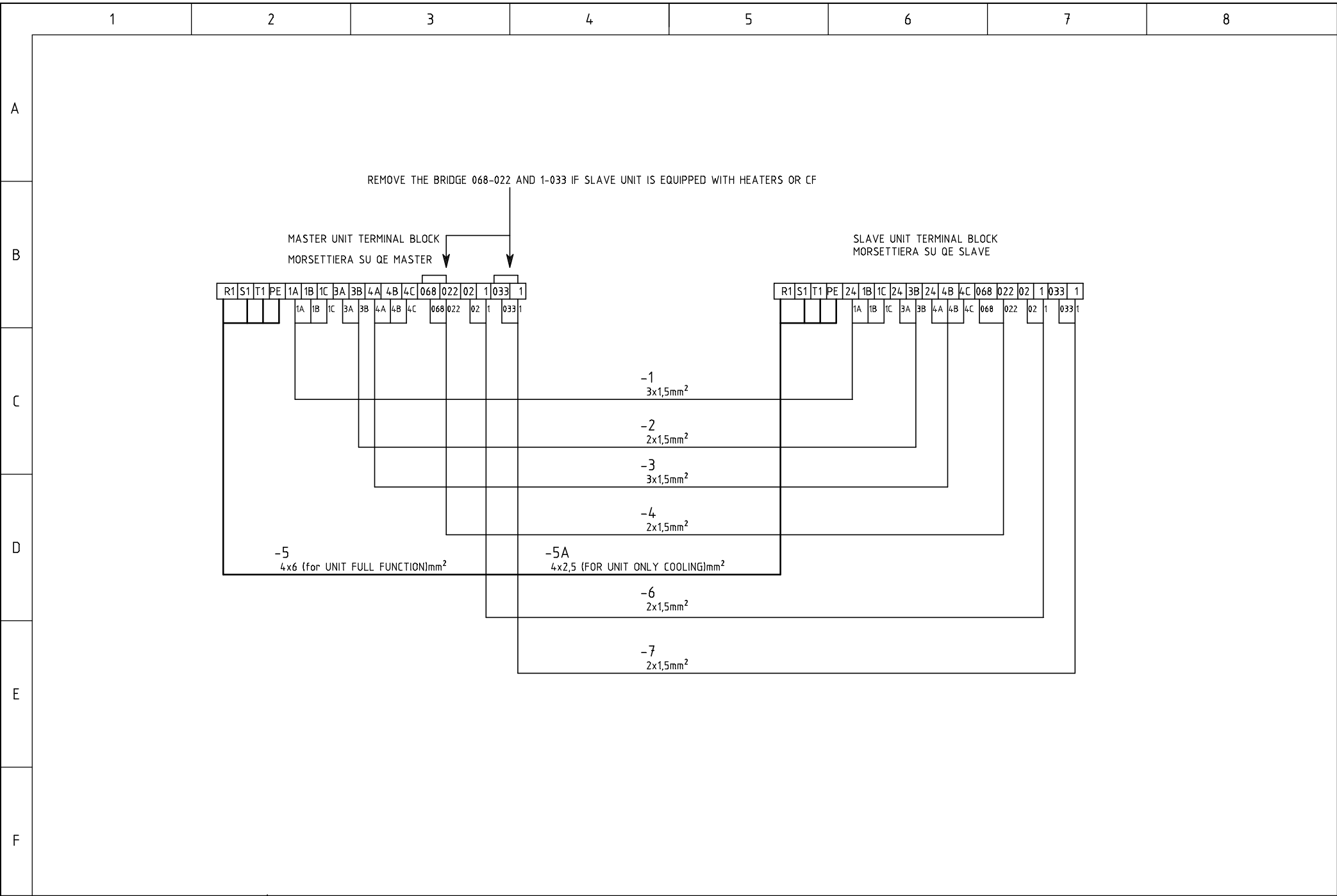

c			Date	04.07.01	Wiring diagram name	Code	318814	F+C+H	400 Vac 50-60 Hz				
b			Signature	F.A.	<b>318814B</b>					LAYOUT			
a			Contr.	G.G.									
Modification	Date	Date	Norm.	EN60204-1	Replaced for:	Replaced by:	Origin:	TYPE:	HIMOD 55-85C	File: 318814B	3 Layout	Sheet 20 of 24	Continue

1		2		3		4		5		6		7		8	
QUANTITY	ARTICLE CODE	DESCRIPTION				TECHNICAL DATA				CATALOGUE NO.	IDENTIFIER	RE.	MANUFACTURER	Code	
A	32	MICROFACE CARD MICROFACE-PLATINE SCHEMA MICROFACE									-A1	/18.3			
		POWER FACTOR CORR. CAPACITOR KONDENSATOR BLINDSTROMKOMPENSATION CONDENS. RIFAS. VENTILATORE									-C1	/4.3			
		POWER FACTOR CORR. CAPACITOR KONDENSATOR BLINDSTROMKOMPENSATION CONDENS. RIFAS. VENTILATORE									-C2	/4.6			
B		CLOGGED FILTER ALARM FILTERWARNUNG ALLARME FILTRI SPORCHI									-CF	/12.6			
		CLOGGED FILTER ALARM FILTERWARNUNG ALLARME FILTRI SPORCHI									-CF1	/12.6			
C		MODULATING COLD WATER VALVE MODULIERENDES KALTWASSERVENTIL VALVOLA ACQUA FREDDA MODULANTE									-CWVM	/9.8			
		WATER FLOWMETER SRÖMUNGSWÄCHTER FLUSSOSTATO ACQUA									-FS	/13.1			
		ON/OFF HOT WATER VALVE HEISSWASSERVENTIL AUF/ZU VALVOLA ACQUA CALDA ON/OFF									-HWV	/10.7			
D		HOT WATER VALVE 0-10 V dc HEISSWASSERVENTIL 0-10 V;GLEICHSTROM VALVOLA ACQUA CALDA 0-10Vcc									-HWVM	/15.7			
		REMOTE ON/OFF EXTERN EIN-AUS ON/OFF REMOTO									-S	/12.2			
		USER 1 INPUT BENUTZEREINGANG 1 INGRESSO UTENTE 1									-S2	/12.4			
E		HEATER SAFETY THERMOSTAT HEIZUNGS-SICHERHEITSTHERMOSTAT THERMOSTATO SIC. RES. ELETTRICHE									-ST12	/10.6			
		HEATER SAFETY THERMOSTAT HEIZUNGS-SICHERHEITSTHERMOSTAT THERMOSTATO SIC. RES. ELETTRICHE									-ST13	/10.6			
		WATER HIGH TEMPERATURE TSTAT WASSEITEMPERATUR ZU HOCH T-STATO ALTA TEMP. ACQUA									-ST14	/12.7			
F		HUMIDIFIER CURRENT TRANSFORMER STROMWANDLER BEFEUCHTER TRASFORMATORE DI CORRENTE UMIDIFICATORE									-TA	/6.4			
		DAMPER MOTOR KLAPPENSTELLMOTOR MOTORE SERRANDA									-Y	/8.5			
		HUMIDIFIER CHARGE SOLENOID VALVE MAGNETVENTIL-BEFEUCHTEREINSPEISUNG ELETTROVALVOLA CARICO UMIDIFICATORE									-YV7	/11.2			

c		Date	04.07.01	Wiring diagram name				Code	318814	F+C+H	400 Vac	50-60 Hz	COMPONENT LIST			
b		Signature	T.A.	318814B												
a		Contr.	G.G.							TYPE:	HIMOD 55-85C	File:	318814B	4 Lista componenti		
Modification	Date	Date	Norm.	EN60204-1	Replaced for:	Replaced by:	Origin:						Sheet 21 of 24	Continue 22		

1		2		3		4		5		6		7		8	
QUANTITY	ARTICLE CODE	DESCRIPTION				TECHNICAL DATA		CATALOGUE NO.	IDENTIFIER	RE.	MANUFACTURER	Code			
A		HUMIDIFIER DRAIN SOLENOID VALVE MAGNETVENTIL-BEFEUCHTERENTLEERUNG ELETTROVALVOLA SCARICO UMIDIFICATORE							-YV07	/11.3					
		1st STEP ELECTRIC HEAT. ELEKTROHEIZUNG 1. STUFE RISC. ELETTR. 1° GRADINO							-EH5	/5.3					
		2nd STEP ELECTRIC HEAT. ELEKTROHEIZUNG 2. STUFE RISC. ELETTR. 2° GRADINO							-EH6	/5.4					
B		HUMIDIFIER BEFEUCHTER UMIDIFICATORE							-EH7	/6.4					
		FAN 1 VENTILATOR 1 VENTILATORE 1							-EV1	/4.3					
		FAN 2 VENTILATOR 2 VENTILATORE 2							-EV2	/4.7					
C		FAN 1 INNER KLIXON KLIXON VENTILATOR 1 KLIXON INTERNO VENTILATORE 1							-FR1	/9.4					
		FAN 2 INNER KLIXON KLIXON VENTILATOR 2 KLIXON INTERNO VENTILATORE 2							-FR2	/9.6					
D		FAN 1 DIFF. PRESSURE SWITCH DIFFERENTIALDRUCKSCHALTER VENTILATOR 1 PRESSOSTATO DIFF. VENTIL. 1							-PSV1	/14.2					
		ON SLAVE UNIT  SU UNITA' SLAVE							-PSV1A	/14.3					
		FAN 2 DIFF. PRESSURE SWITCH DIFFERENTIALDRUCKSCHALTER VENTILATOR 2 PRESSOSTATO DIFF. VENTIL. 2							-PSV2	/14.3					
		ON SLAVE UNIT  SU UNITA' SLAVE							-PSV2A	/14.4					
E		FLOODING ALARM ALARM WASSERAUSTRITT ALLARME ALLAGAMENTO							-R	/14.6					
		AIR SUCTION TEMP. PROBE TEMPERATURFÜHLER LUFTANSAUG SONDA DI TEMP. ASP. ARIA							-RT1	/14.7					
		LEVEL PROBE WASSERSTANDSFÜHLER SENSORE DI LIVELLO							-SL	/6.4					
F	2	LA1-KN11	FAN 1 CONTACTOR VENTILATORMOTOR SCHÜTZ Nr 1 CONTATTORE VENTILATORE 1			LA1-KN11 PER MINICONTATTORE	LA1-KN11	-KM1	/9.4	TELEMECANIQUE					
			FAN 2 CONTACTOR VENTILATORMOTOR SCHÜTZ Nr 2 CONTATTORE VENTILATORE 2			LA1-KN11 PER MINICONTATTORE	LA1-KN11	-KM2	/9.6	TELEMECANIQUE					

c	Date	04.07.01	Wiring diagram name		Code	318814	F+C+H	400 Vac	50-60 Hz	COMPONENT LIST		
b	Signature	T.A.	318814B		318814	TYPE: HIMOD 55-85C	File: 318814B	4 Lista componenti				
a	Contr.	G.G.						Sheet 22 of 24				Continue 23
Modification	Date	Date	Norm.	EN60204-1	Replaced for:	Replaced by:	Origin:					

1		2		3		4		5		6		7		8		
QUANTITY	ARTICLE CODE	DESCRIPTION				TECHNICAL DATA		CATALOGUE NO.		IDENTIFIER		RE.	MANUFACTURER	Code		
A	1	LAD4VE	HUMIDIFIER CONTACTOR BEFEUCHTER SCHÜTZ CONTATTORE UMIDIFICATORE				LAD4VE		LAD4VE		-KM7		/11.6	TELEMECANIQUE	254671	
	1	LBI 24	DAMPER CONTROL RELAY RELAIS KLAPPENREGELUNG RELE' COMANDO SERRANDA				LBI 24		LBI 24		-A4		/8.4	RINCK ELECTRONIC	255197	
	1	LC1D09B7	HUMIDIFIER CONTACTOR BEFEUCHTER SCHÜTZ CONTATTORE UMIDIFICATORE				24V AC, 1NA+1NC		LC1D09B7 LS4.10 24		-KM7		/11.6	TELEMECANIQUE AEG	255816	
B	2	LC1D09B7+LAD8-N11	ELECTR. HEAT. CONTACTOR 1 ELEKTROHEIZUNG SCHÜTZ 1 CONTATTORE RISC. FLETTR. 1								-KM5		/10.6			
			ELECTR. HEAT. CONTACTOR 2 ELEKTROHEIZUNG SCHÜTZ 2 CONTATTORE RISC. FLETTR. 2								-KM6		/10.8			
	2	LC1K0910B72+AUS. SUP.	FAN 1 CONTACTOR VENTILATORMOTOR SCHÜTZ Nr 1 CONTATTORE VENTILATORE 1				24V AC 50/60Hz, 1NA		LC1K0910B72 LS05.10 24		-KM1		/9.4	TELEMECANIQUE AEG		
C			FAN 2 CONTACTOR VENTILATORMOTOR SCHÜTZ Nr 2 CONTATTORE VENTILATORE 2				24V AC 50/60Hz, 1NA		LC1K0910B72 LS05.10 24		-KM2		/9.6	TELEMECANIQUE AEG		
	1	LSI	LEVEL PROBE INSULATOR ISOLIERUNG WASSERSTANDSFÜHLER ISOLATORE SENSORE DI LIVELLO				LSI		275905		-LSI		/6.5	HIROSS	275905	
	1	MKPC44/2	ANTI-NOISE FILTER ENTSTÖRFILTER FILTRO ANTIDISTURBO				MKPC44/2		MKPC44/2		-C3		/7.4	ARCOTRONICS	254324	
D	1	OHY2AJ 19501	MAIN SWITCH HAUPTSCHALTER INTERRUTTORE GENERALE				OHY2AJ		OHY2AJ 19501		-QS		/3.2	ABB TECHNOELECTRIC	256994	
	1	OT63E4 TK80A 4P	MAIN SWITCH HAUPTSCHALTER INTERRUTTORE GENERALE				OT63E4		OT63E4 TK80A 4P		-QS		/3.2	ABB TECHNOELECTRIC		
	1	OX55X120	MAIN SWITCH HAUPTSCHALTER INTERRUTTORE GENERALE				OX55X120		OX55X120		-QS		/3.2	ABB		
E	2	SCHEDA CISE ALLARMI	ALARM CARD LARM-KARTE SCHEDA RINVIO ALLARMI				SCHEDA CISE 124 5 RELE'				-A2		/16.3	HIROSS	275148	
			ALARM CARD LARM-KARTE SCHEDA RINVIO ALLARMI				SCHEDA CISE 124 5 RELE'				-A3		/16.3	HIROSS	275148	
	2	SF520263	AUXILIARY FUSE 24 V SICHERUNG STEUERSTROMKREIS 24 V FUSIBILE AUSILIARI 24V				6.3A F		SF520263		-FU1		/7.4	OMEGA	254731	
F			AUXILIARY FUSE 24 V SICHERUNG STEUERSTROMKREIS 24 V FUSIBILE AUSILIARI 24V				6.3A F		SF520263		-FU2		/7.4	OMEGA	254731	
	2	ZOCCOLO X 40.52	VALVE CONTROL RELAY (OPENING) RELAIS FÜR VENTIL (ÖFFNEN) RELE' COMANDO VALVOLA (APERTURA)				95.85.1		95.85.1		-KA1		/9.2	FINDER	000000	

c	Date	04.07.01	Wiring diagram name		Code		F+C+H		400 Vac		50-60 Hz		COMPONENT LIST		
b	Signature	T.A.	318814B		318814										
a	Contr.	G.G.					TYPE:		HIMOD 55-85C		File: 318814B		4 Lista componenti Sheet 23 of 24 Continue 24		
Modification	Date	Date	Norm.	EN60204-1	Replaced for:	Replaced by:	Origin:								

1		2		3		4		5		6		7		8		
QUANTITY	ARTICLE CODE	DESCRIPTION				TECHNICAL DATA				CATALOGUE NO.	IDENTIFIER	RE.	MANUFACTURER	Code		
A		VALVE CONTROL RELAY (CLOSING) RELAIS FÜR VENTIL (SCHLIESSEN) RELE' COMANDO VALVOLA (CHIUSURA)				95.85.1				95.85.1	-KA2	/9.3	FINDER	000000		
	2	40.52 24Vac	VALVE CONTROL RELAY (OPENING) RELAIS FÜR VENTIL (ÖFFNEN) RELE' COMANDO VALVOLA (APERTURA)				40.52 24Vac				40.52 24Vac	-KA1	/9.2	FINDER	256152	
			VALVE CONTROL RELAY (CLOSING) RELAIS FÜR VENTIL (SCHLIESSEN) RELE' COMANDO VALVOLA (CHIUSURA)				40.52 24Vac				40.52 24Vac	-KA2	/9.3	FINDER	256152	
B	1	51AT40K	FAN/S AUTOTRANSFORMER REGELTRAFO FÜR VENTILATOREN AUTOTRASFORMATORE VENTILATORE/1				6,7KVA				51AT40K	-TM	/4.3	MARINI	256299	
	1	51TMA53	TRANSFORMER TRANSFORMATORE TRASFORMATORE				130VA				51TMA53	-TC	/7.4	MARINI		
	2	115 131.06+F6,3F	AUXILIARY FUSE 24 V SICHERUNG STEUERSTROMKREIS 24 V FUSIBILE AUSILIARI 24V				M4/8.SF GRIGIO				115 131.06	-FU1	/7.4	ENTRELEC	255716	
C			AUXILIARY FUSE 24 V SICHERUNG STEUERSTROMKREIS 24 V FUSIBILE AUSILIARI 24V				M4/8.SF GRIGIO				115 131.06	-FU2	/7.4	ENTRELEC	255716	
	1	24267	TRANSF. AUTOMATIC SWITCH AUTOMATIK-SCHALTER INTERR. AUTOMATICO TRASFORMATORE				6A 6KA "C"				24267	-QF8	/7.3	MERLIN GERIN	256515	
	1	24282	FAN AUTOMATIC SWITCH AUTOM. VENTILATORSCHALTER INTERRUPTORE AUTOM. VENTILATORE				10A 6KA "C"				24282	-QF1	/4.3	MERLIN GERIN		
D	1	24284 E83 C16	HUMIDIFIER AUTOM. SWITCH AUTOM. SCHALTER BEFEUCHTER INTERR. AUTOM. UMIDIFICATORE				16A 6KA "C"				24284 E83 C16	-QF7	/6.4	MERLIN GERIN AEG		
	1	24285 E83 C20	HEATER AUTOM. SWITCH AUTOM. SCHALTER HEIZUNG INTERR. AUTOM. RESISTENZE				20A 6KA "C"				24285 E83 C20	-QF5	/5.3	MERLIN GERIN AEG		
E																
F																

c		Date	04.07.01	Wiring diagram name				Code	318814	F+C+H	400 Vac	50-60 Hz	COMPONENT LIST			
b		Signature	T.A.	318814B												
a		Contr.	G.G.							TYPE:	HIMOD 55-85C	File:	318814B	4 Lista componenti		
Modification	Date	Date	Norm.	EN60204-1	Replaced for:	Replaced by:	Origin:						Sheet 24 of 24	Continue		