

Document list

	Document type	Sheet	Description	Rev.
A	0 Copertina	1	Document list	
	1 Specifiche elettriche	2	Electrical specification	
	2 Schema	3	Power	
	2 Schema	4	Power	
	2 Schema	5	Power	
	2 Schema	6	Power	
	2 Schema	7	Auxiliaries 24V	
	2 Schema	8	Auxiliaries 24V	
B	2 Schema	9	Auxiliaries 24V	
	2 Schema	10	Auxiliaries 24V	
	2 Schema	11	Auxiliaries 24V	
	2 Schema	12	Auxiliaries 24V	
	2 Schema	13	Auxiliaries 24V	
	2 Schema	14	Auxiliaries 24V	
	2 Schema	15	Auxiliaries 24V	
	2 Schema	16	Auxiliaries 24V	
C	3 Layout	17	LAYOUT	
	3 Layout	18	LAYOUT	
	3 Layout	19	LAYOUT	
	3 Layout	20	LAYOUT	
	3 Layout	21	LAYOUT	
	4 Lista componenti	22	COMPONENT LIST	
	4 Lista componenti	23	COMPONENT LIST	
	4 Lista componenti	24	COMPONENT LIST	
	4 Lista componenti	25	COMPONENT LIST	
	4 Lista componenti	26	COMPONENT LIST	
D				
E				
F				

Wire Colour Code	
BLACK	Power
RED	Auxiliaries 24V AC
BLUE	Auxiliaries 24V DC
YELLOW/GREEN	Earth

Reference code: /3 .6
 Sheet ← → Column

Customer:
Order:
Supply: 400 V 50 Hz
Auxiliary circuits: 24 V
NOTE 1
NOTE 2
NOTE 3

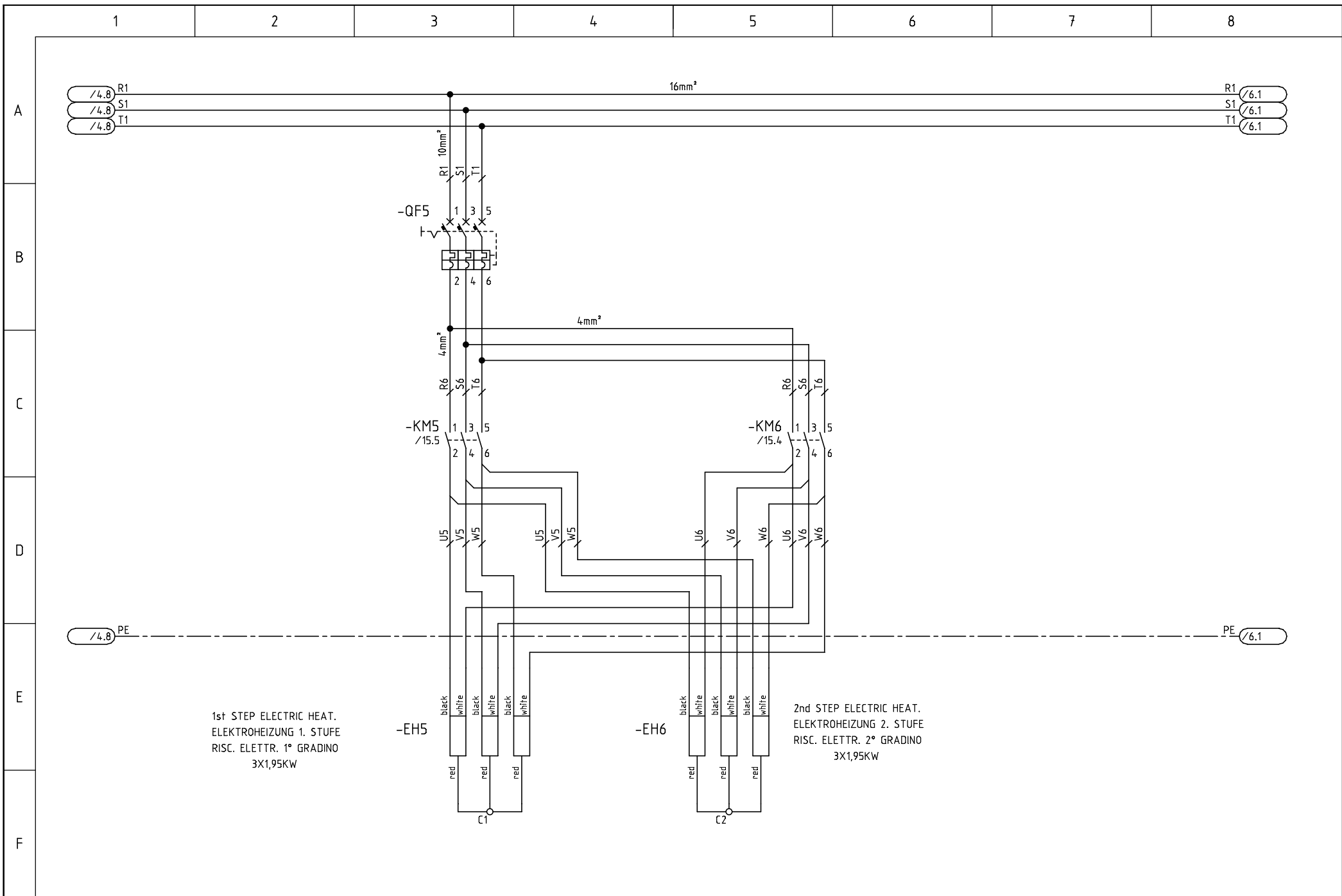

c		Date	12.01.2001	Wiring diagram name	Code	F+C+H	400 Vac	50 Hz			
b		Signature	G.A.	CD0105E02-G	317820				Power		
a		Contr.	G.G.			TYPE:			2 Schema		
Modification	Date	Date	Norm.	EN60204-1	Replaced for:	Replaced by:	Origin:	CP/HIMOD 40 D/F/H	File: 317820	Sheet 5 of 26	Continue 6

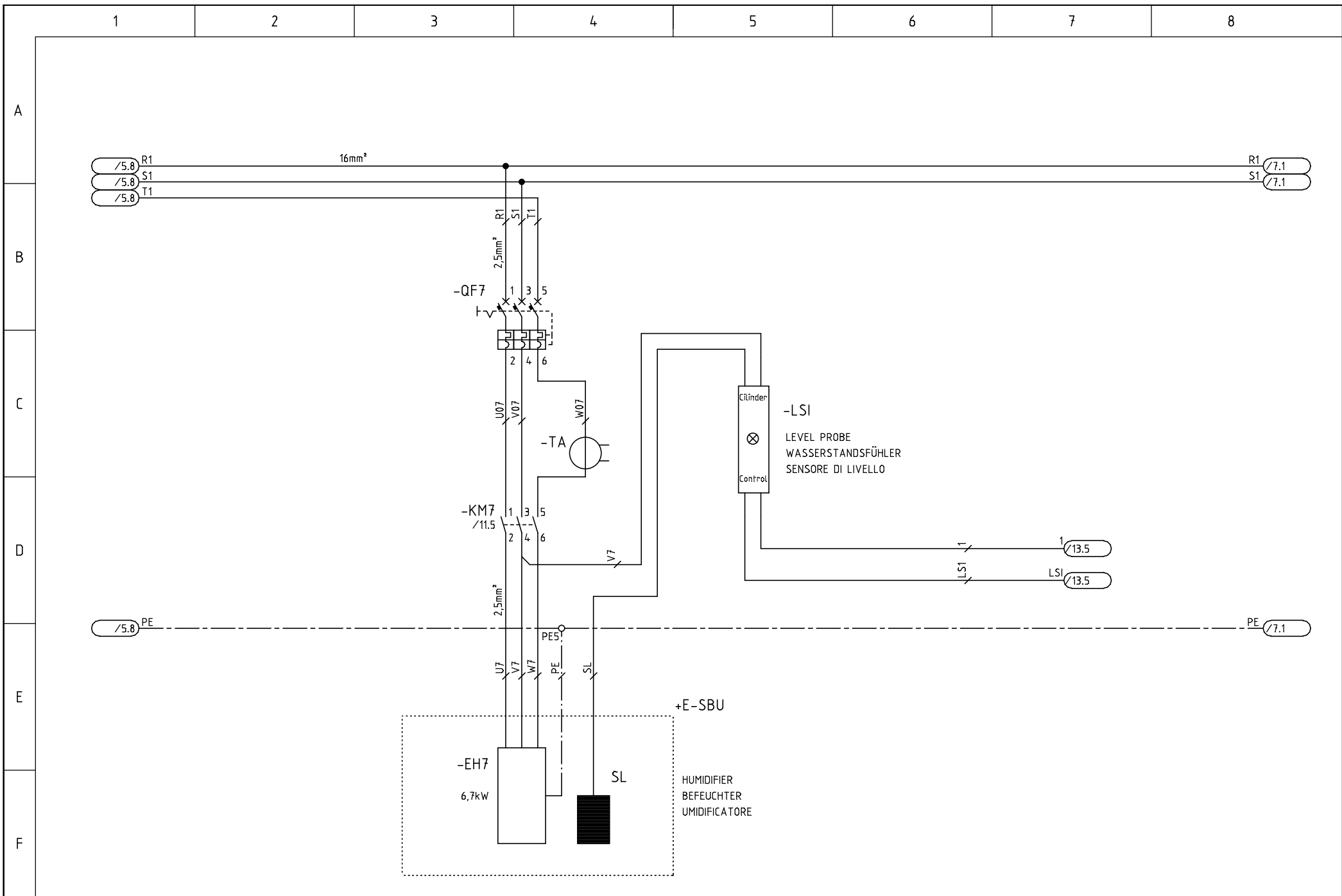

c		Date	12.01.2001	Wiring diagram name	Code	F+C+H	400 Vac	50 Hz	
b		Signature	G.A.	CD0105E02-G	317820	CP/HIMOD 40 D/F/H	File:	317820	Power
a		Contr.	G.G.						2 Schema
Modification	Date	Date	Norm.	EN60204-1	Replaced for:	Replaced by:	Origin:	Sheet 6 of 26	Continue 7

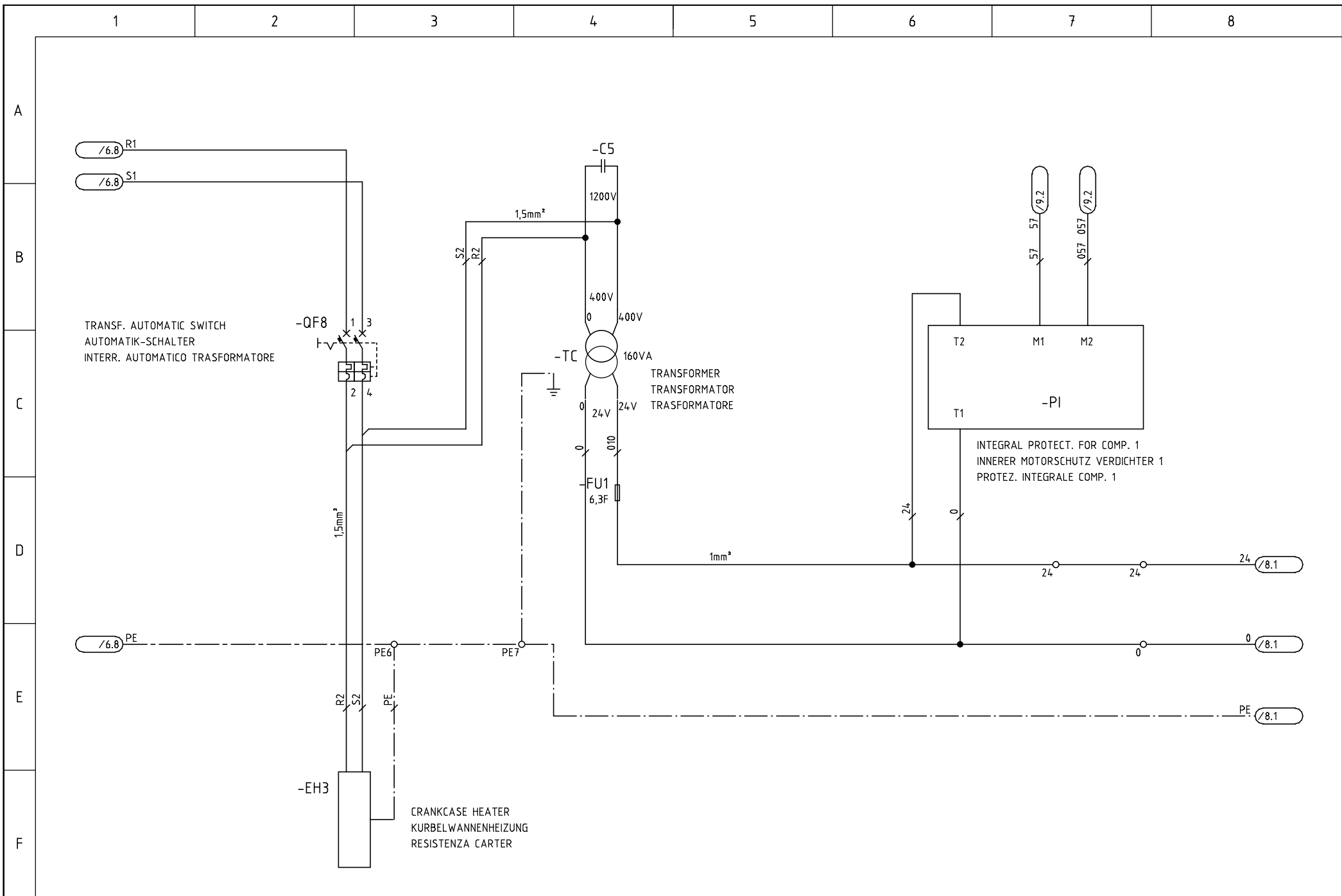

c		Date	12.01.2001	Wiring diagram name	Code	F+C+H	400 Vac	50 Hz	
b		Signature	G.A.	CD0105E02-G	317820				Auxiliaries 24V
a		Contr.	G.G.			TYPE:	CP/HIMOD 40 D/F/H	File:	317820
Modification	Date	Date	Norm.	EN60204-1	Replaced for:	Replaced by:	Origin:		Sheet 7 of 26
									Continue 8

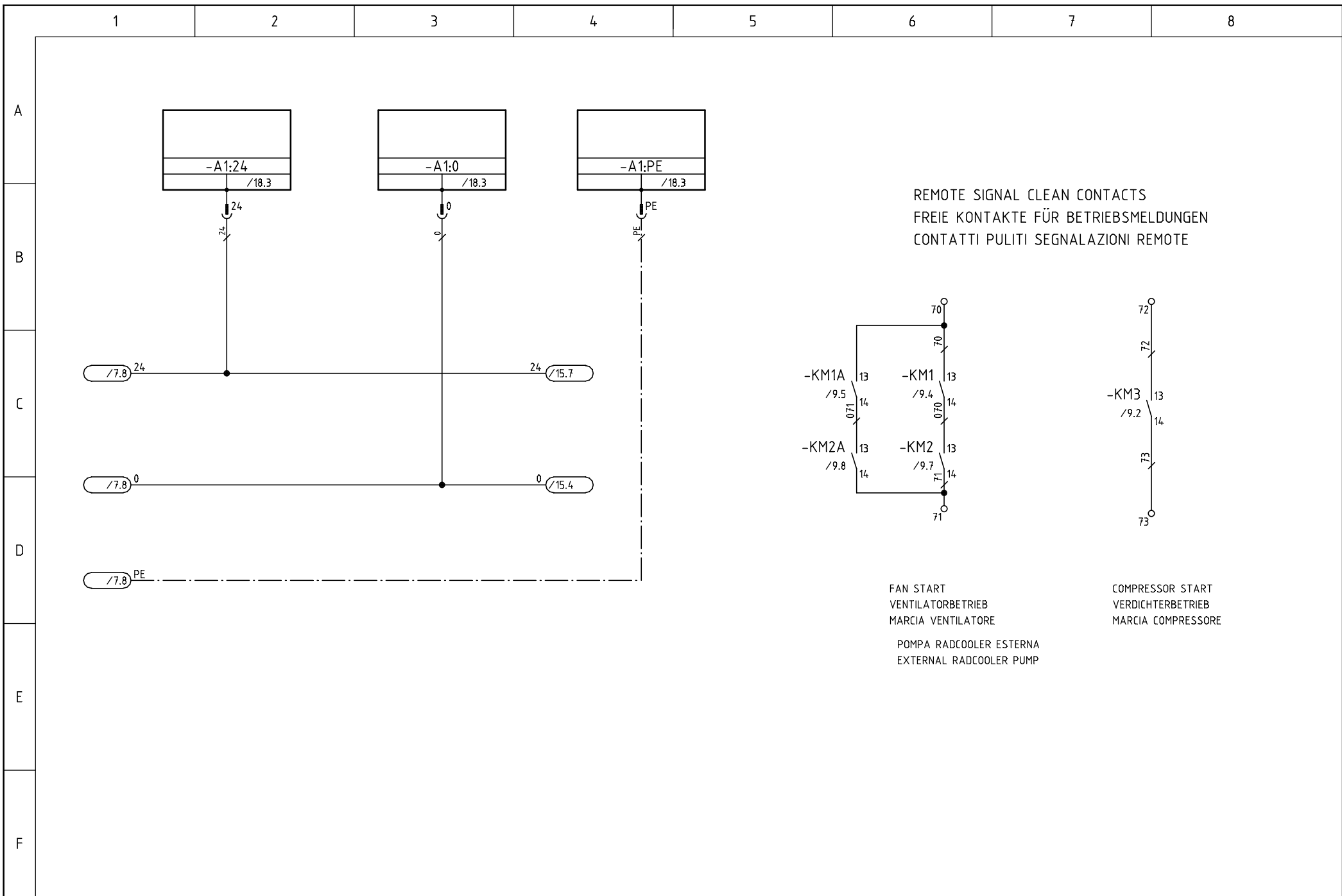

REMOTE SIGNAL CLEAN CONTACTS
 FREIE KONTAKTE FÜR BETRIEBSMELDUNGEN
 CONTATTI PULITI SEGNALAZIONI REMOTE

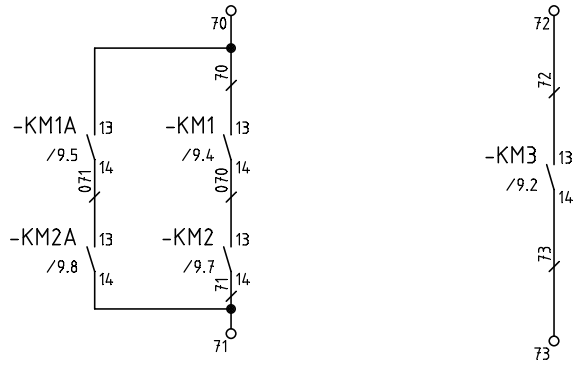

FAN START
 VENTILATORBETRIEB
 MARCIA VENTILATORE

COMPRESSOR START
 VERDICHTERBETRIEB
 MARCIA COMPRESSORE

POMPA RADCOOLER ESTERNA
 EXTERNAL RADCOOLER PUMP

c		Date	12.01.2001	Wiring diagram name	Code	F+C+H	400 Vac	50 Hz	Auxiliaries 24V
b		Signature	G.A.	CD0105E02-G	317820	TYPE:			2 Schema
a		Contr.	G.G.			CP/HIMOD 40 D/F/H	File:	317820	Sheet 8 of 26
	Modification	Date	Date	Norm.	EN60204-1	Replaced for:	Replaced by:	Origin:	Continue 9

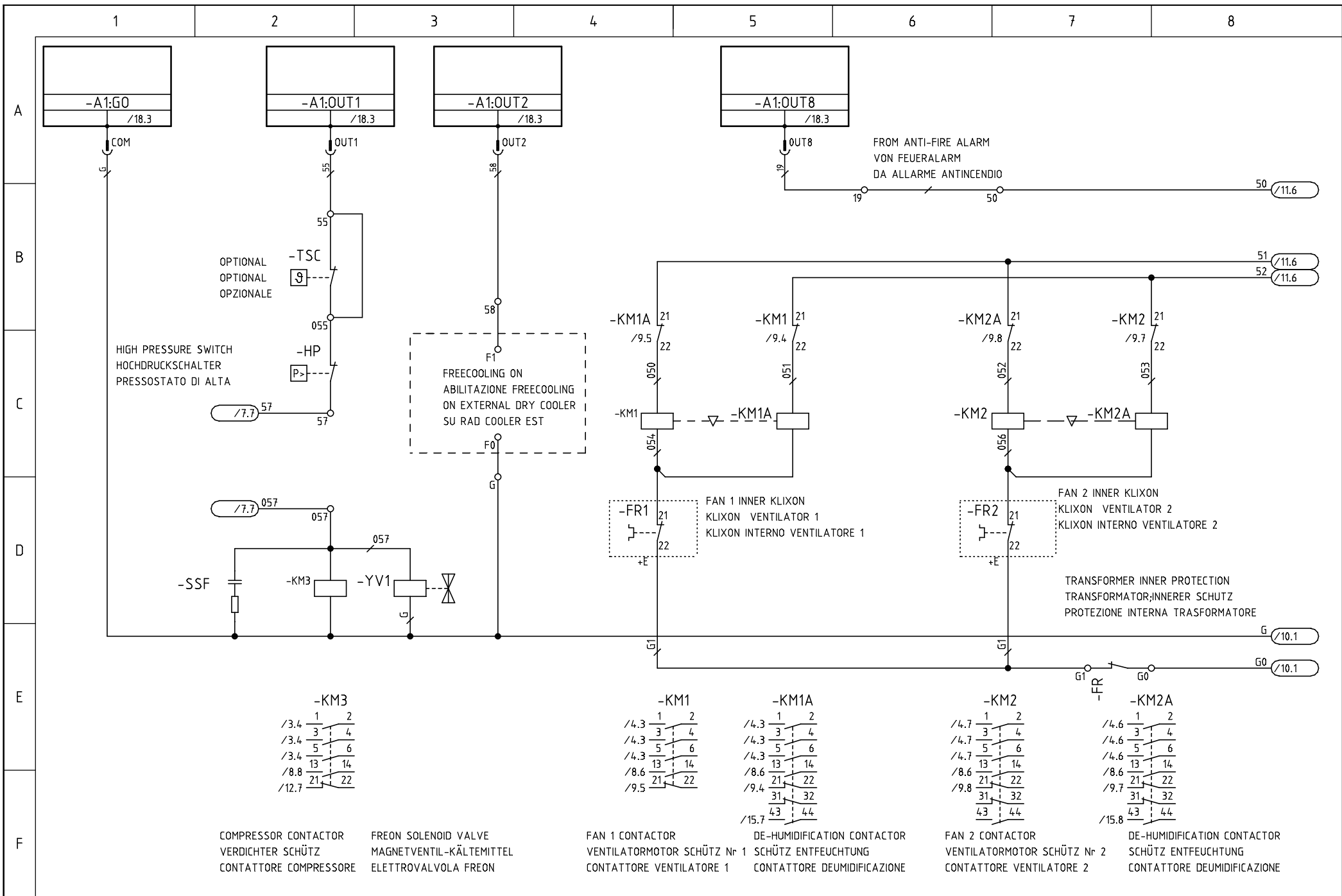

c		Date	12.01.2001	Wiring diagram name	Code	F+C+H	400 Vac	50 Hz	Auxiliaries 24V
b		Signature	E.A.	CD0105E02-G	317820	CP/HIMOD 40 D/F/H	File:	317820	2 Schema
a		Contr.	G.G.						
	Modification	Date	Norm.	Replaced for:	Replaced by:	Origin:			

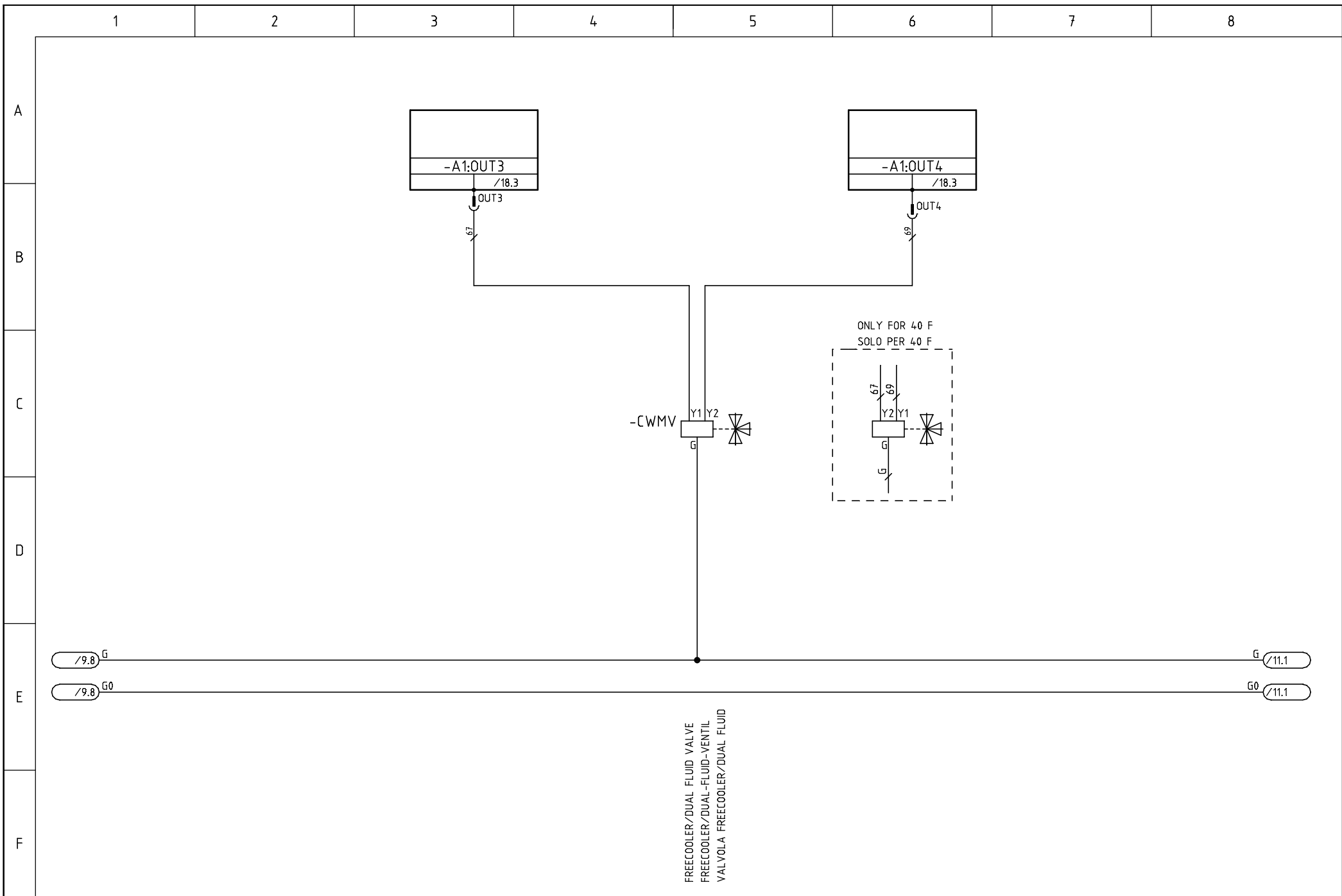

FREE-COOLER/DUAL FLUID VALVE
 FREE-COOLER/DUAL-FLUID-VENTIL
 VALVOLA FREE-COOLER/DUAL FLUID

c		Date	12.01.2001	Wiring diagram name	Code	F+C+H	400 Vac	50 Hz	Auxiliaries 24V
b		Signature	F.A.	CD0105E02-G	317820	CP/HIMOD 40 D/F/H	File: 317820	2 Schema	
a		Contr.	G.G.					Sheet 10 of 26	Continue 11
Modification	Date	Date	Norm.	EN60204-1	Replaced for:	Replaced by:	Origin:		

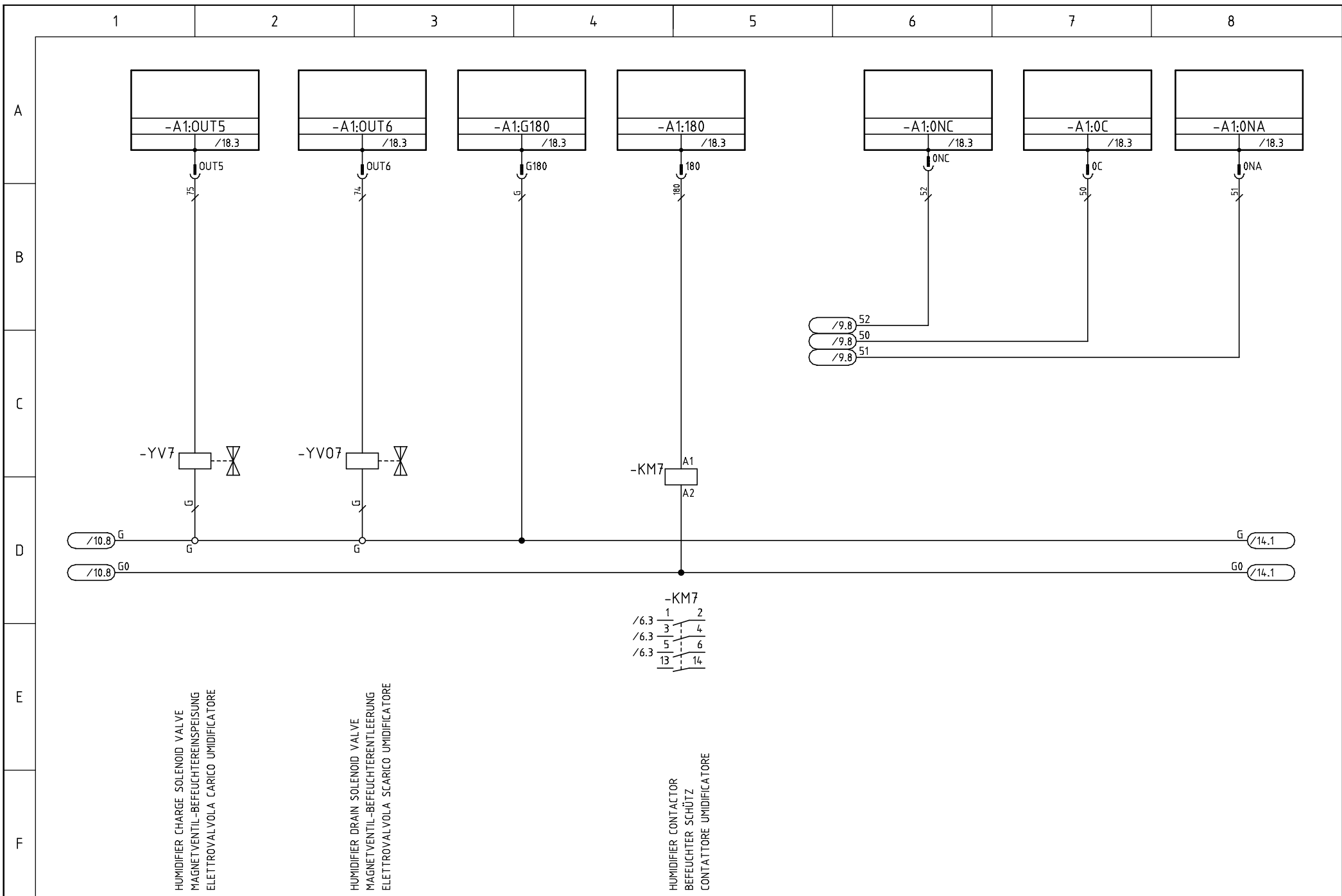

HUMIDIFIER CHARGE SOLENOID VALVE
 MAGNETVENTIL-BEFEUCHTEREINSPEISUNG
 ELETTROVALVOLA CARICO UMIDIFICATORE

HUMIDIFIER DRAIN SOLENOID VALVE
 MAGNETVENTIL-BEFEUCHTERENTLEERUNG
 ELETTROVALVOLA SCARICO UMIDIFICATORE

HUMIDIFIER CONTACTOR
 BEFEUCHTER SCHÜTZ
 CONTATTATORE UMIDIFICATORE

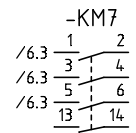

c		Date	12.01.2001	Wiring diagram name	Code	F+C+H	400 Vac	50 Hz	
b		Signature	E.A.	CD0105E02-G	317820				Auxiliaries 24V
a		Contr.	G.G.			TYPE:	CP/HIMOD 40 D/F/H	File:	317820
Modification	Date	Date	Norm.	EN60204-1	Replaced for:	Replaced by:	Origin:		Sheet 11 of 26
									Continue 12

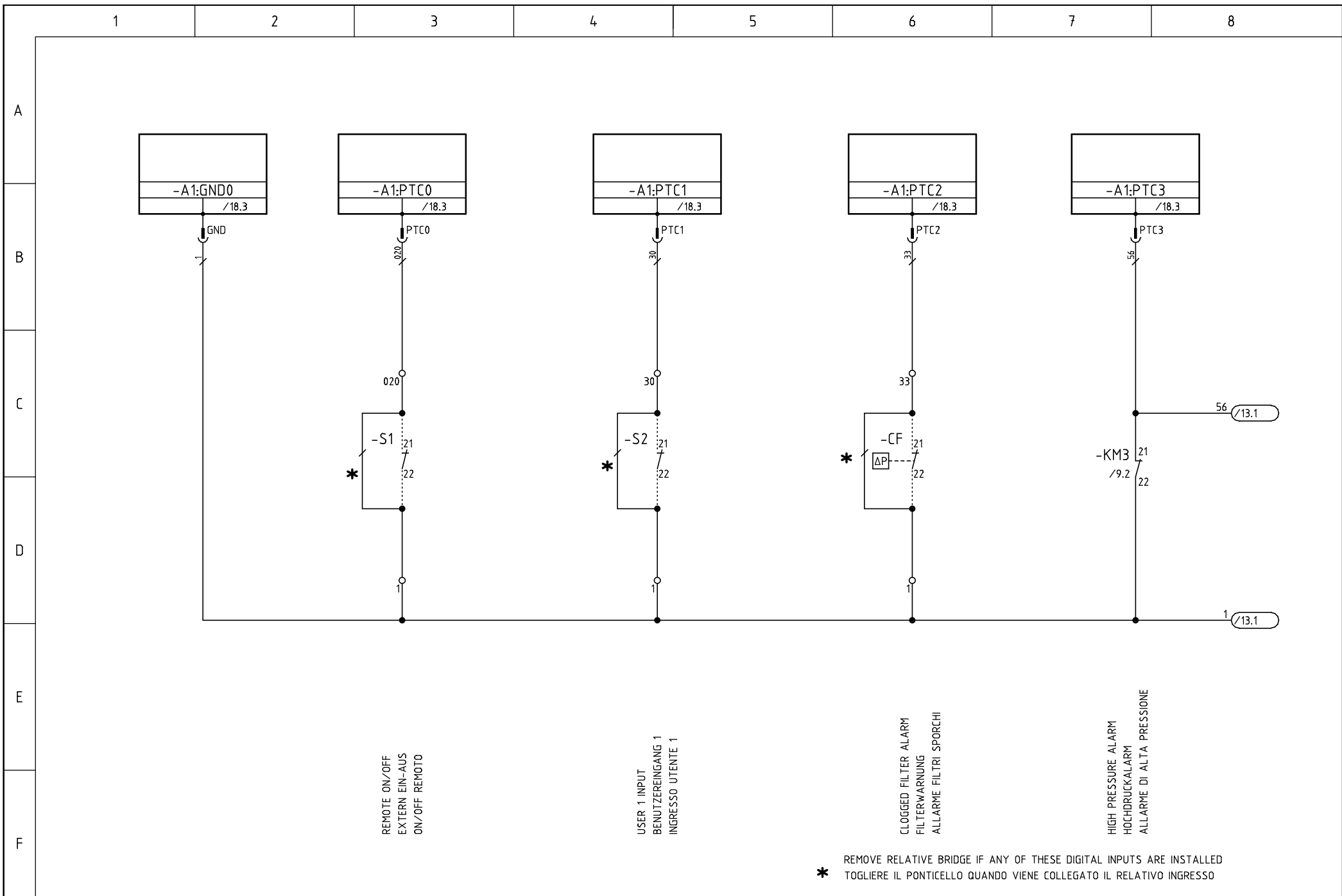

REMOTE ON/OFF
 EXTERN EIN-AUS
 ON/OFF REMOTO

USER 1 INPUT
 BENUTZEREINGANG 1
 INGRESSO UTENTE 1

CLOGGED FILTER ALARM
 FILTERWARUNG
 ALLARME FILTRI SPORCHI

HIGH PRESSURE ALARM
 HOCHDRUCKALARME
 ALLARME DI ALTA PRESSIONE

* REMOVE RELATIVE BRIDGE IF ANY OF THESE DIGITAL INPUTS ARE INSTALLED
 * TOGLIERE IL PONTICELLO QUANDO VIENE COLLEGATO IL RELATIVO INGRESSO

c		Date	12.01.2001	Wiring diagram name	Code	F+C+H	400 Vac	50 Hz	Auxiliaries 24V
b		Signature	E.A.	CD0105E02-G	317820	TYPE:			
a		Contr.	G.G.			CP/HIMOD 40 D/F/H	File:	317820	2 Schema
Modification	Date	Date	Norm.	EN60204-1	Replaced for:	Replaced by:	Origin:		Sheet 12 of 26
									Continue 13

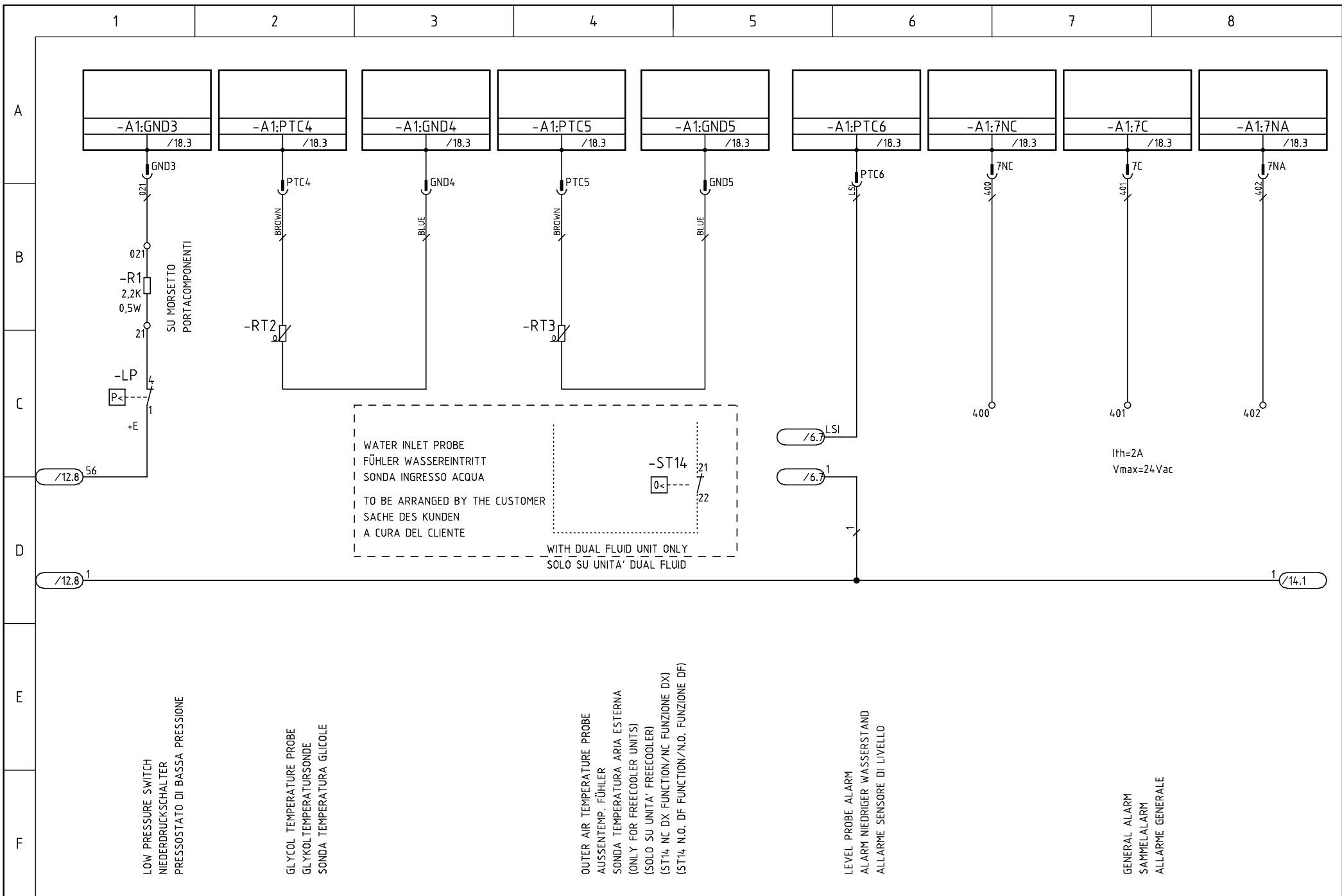

c		Date	12.01.2001	Wiring diagram name	Code	F+C+H	400 Vac	50 Hz	
b		Signature	E.A.	CD0105E02-G	317820	CP/HIMOD 40 D/F/H	File: 317820	2 Schema	Auxiliaries 24V
a		Contr.	G.G.						Sheet 13 of 26
Modification	Date	Date	Norm.	EN60204-1	Replaced for:	Replaced by:	Origin:		

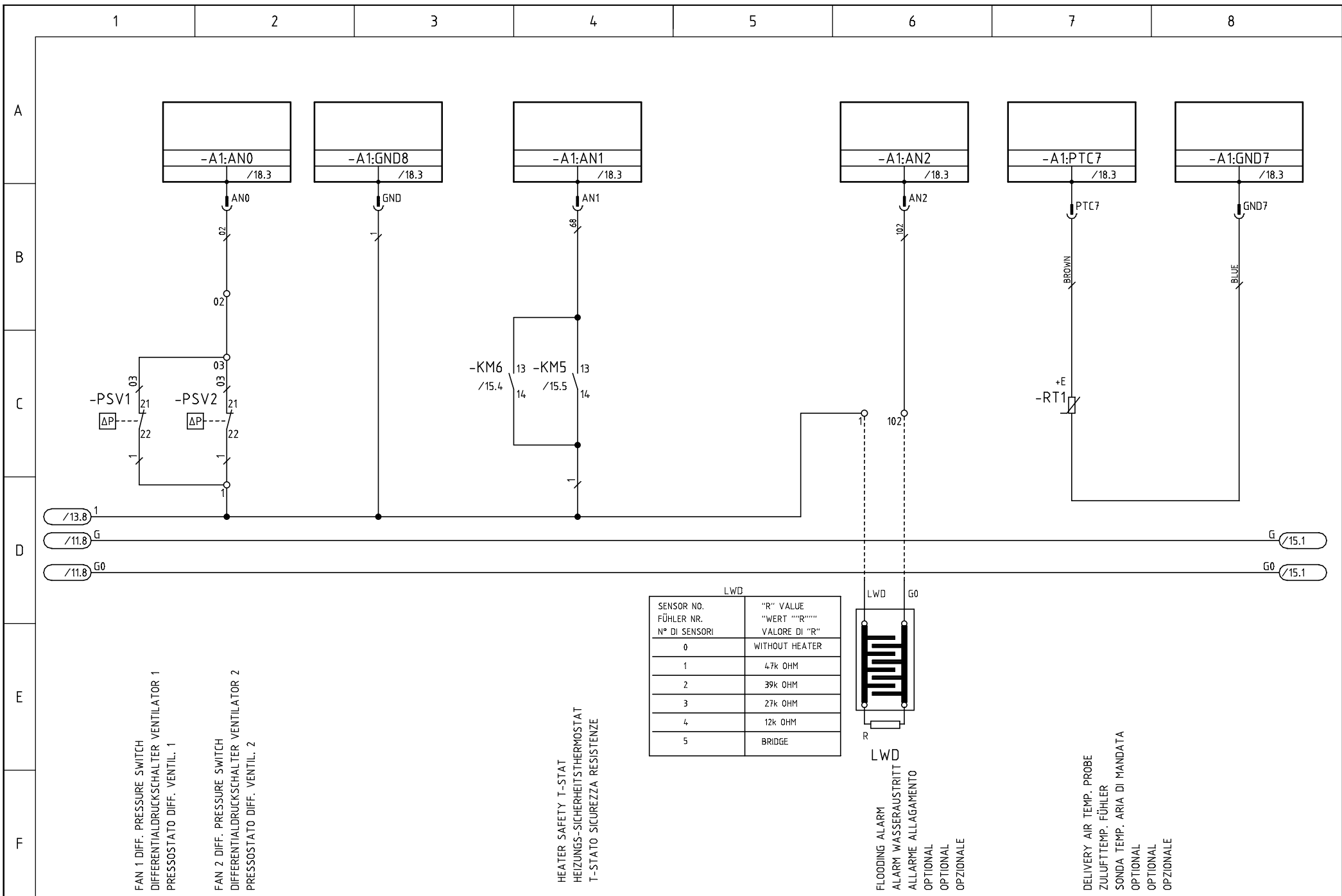

FAN 1 DIFF. PRESSURE SWITCH
DIFFERENTIALDRUCKSCHALTER VENTILATOR 1
PRESSOSTATO DIFF. VENTIL. 1

FAN 2 DIFF. PRESSURE SWITCH
DIFFERENTIALDRUCKSCHALTER VENTILATOR 2
PRESSOSTATO DIFF. VENTIL. 2

HEATER SAFETY T-STAT
HEIZUNGS-SICHERHEITSTHERMOSTAT
T-STATO SICUREZZA RESISTENZE

FLOODING ALARM
ALARME WASSERAUSTRITT
ALLARME ALLAGAMENTO
OPTIONAL
OPTIONAL
OPZIONALE

DELIVERY AIR TEMP. PROBE
ZULUFTTEMP. FÜHLER
SONDA TEMP. ARIA DI MANDATA
OPTIONAL
OPTIONAL
OPZIONALE

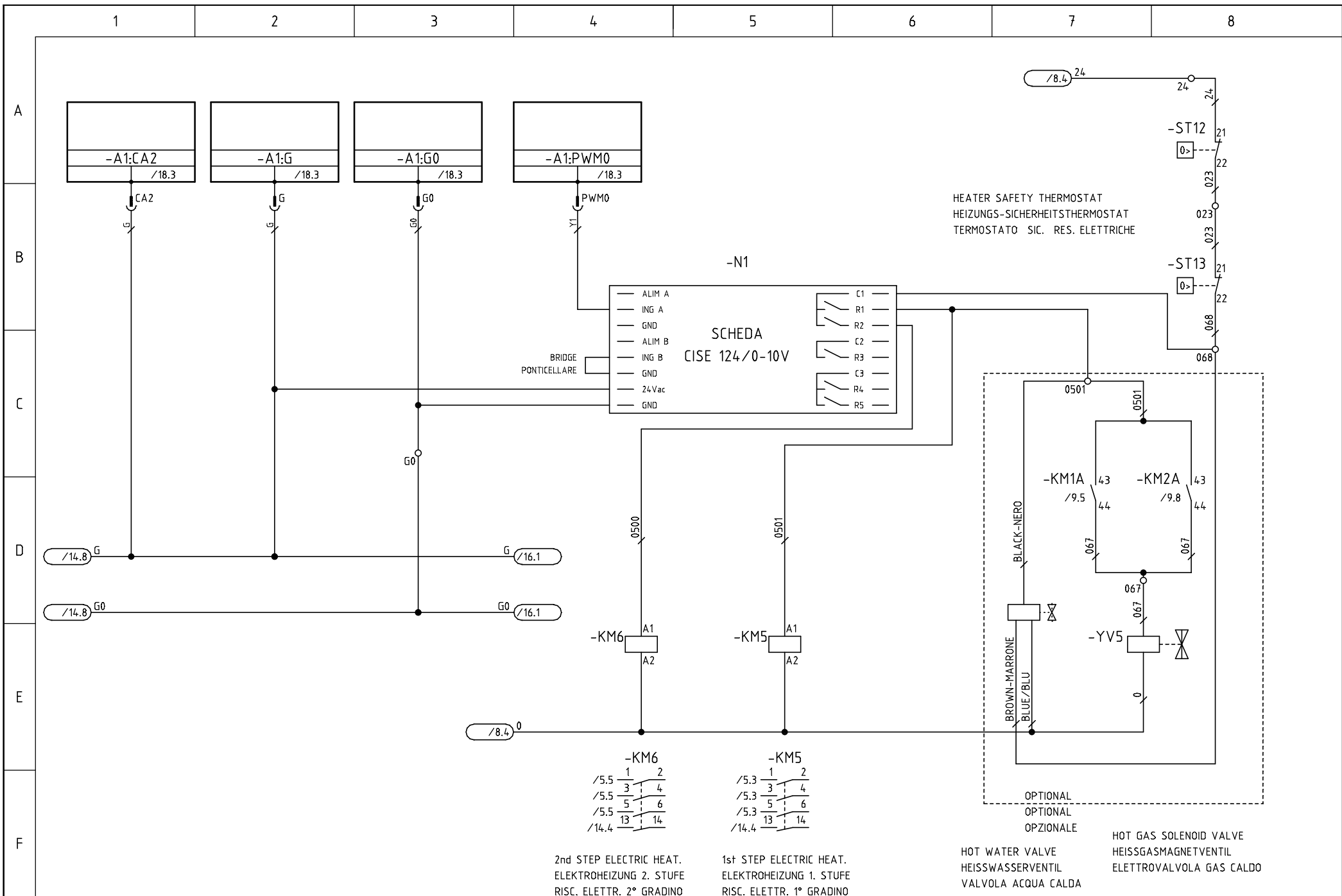

c		Date	12.01.2001	Wiring diagram name	Code	F+C+H	400 Vac	50 Hz	Auxiliaries 24V
b		Signature	F.A.	CD0105E02-G	317820	TYPE:			
a		Contr.	G.G.			CP/HIMOD 40 D/F/H	File:	317820	2 Schema
Modification	Date	Date	Norm.	EN60204-1	Replaced for:	Replaced by:	Origin:		Sheet 15 of 26

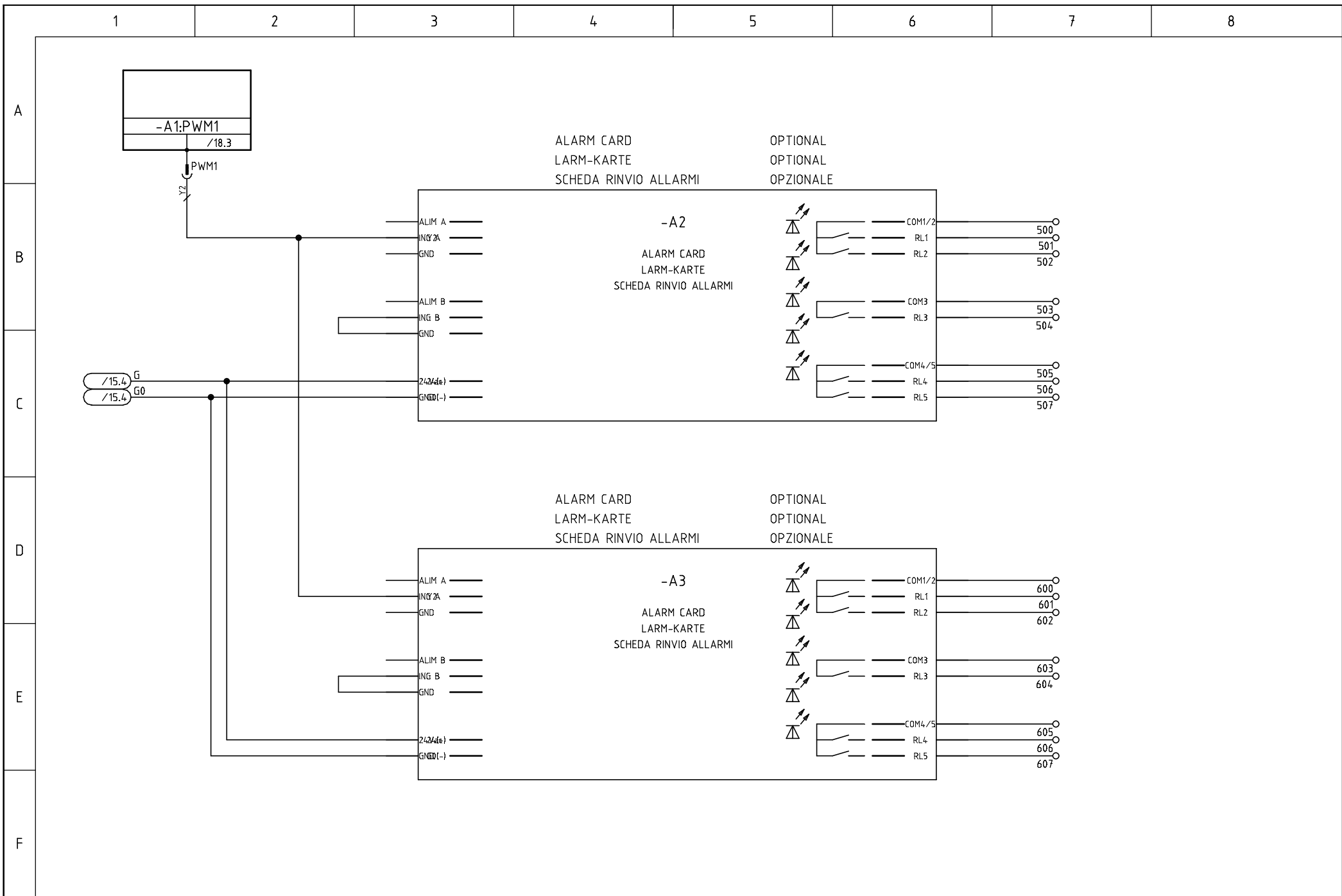

c		Date	12.01.2001	Wiring diagram name	Code	F+C+H	400 Vac	50 Hz	
b		Signature	F.A.	CD0105E02-G	317820	CP/HIMOD 40 D/F/H	File:	317820	Auxiliaries 24V
a		Contr.	G.G.						2 Schema
Modification	Date	Date	Norm.	EN60204-1	Replaced for:	Replaced by:	Origin:	Sheet 16 of 26	Continue

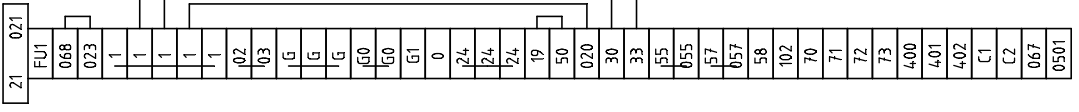
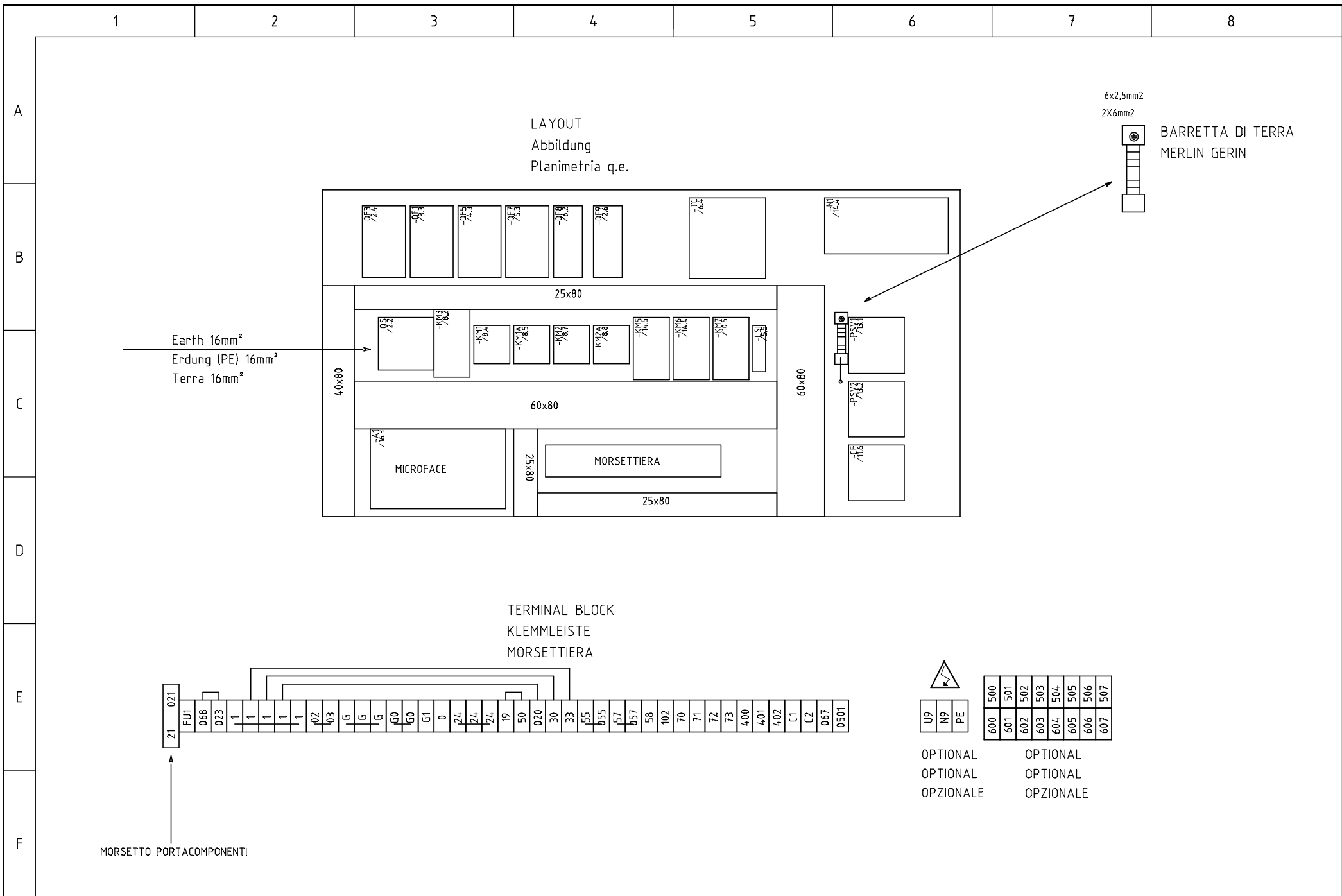

▲		500
U9	N9	501
PE		502
		503
		504
		505
		506
		507

OPTIONAL OPTIONAL
OPTIONAL OPTIONAL
OPZIONALE OPZIONALE

c		Date	12.01.2001	Wiring diagram name	Code	F+C+H	400 Vac	50 Hz	
b		Signature	G.A.	CD0105E02-G	317820	TYPE:	CP/HIMOD 40 D/F/H	File:	317820
a		Contr.	G.G.						
	Modification	Date	Norm.	Replaced for:	Replaced by:	Origin:			

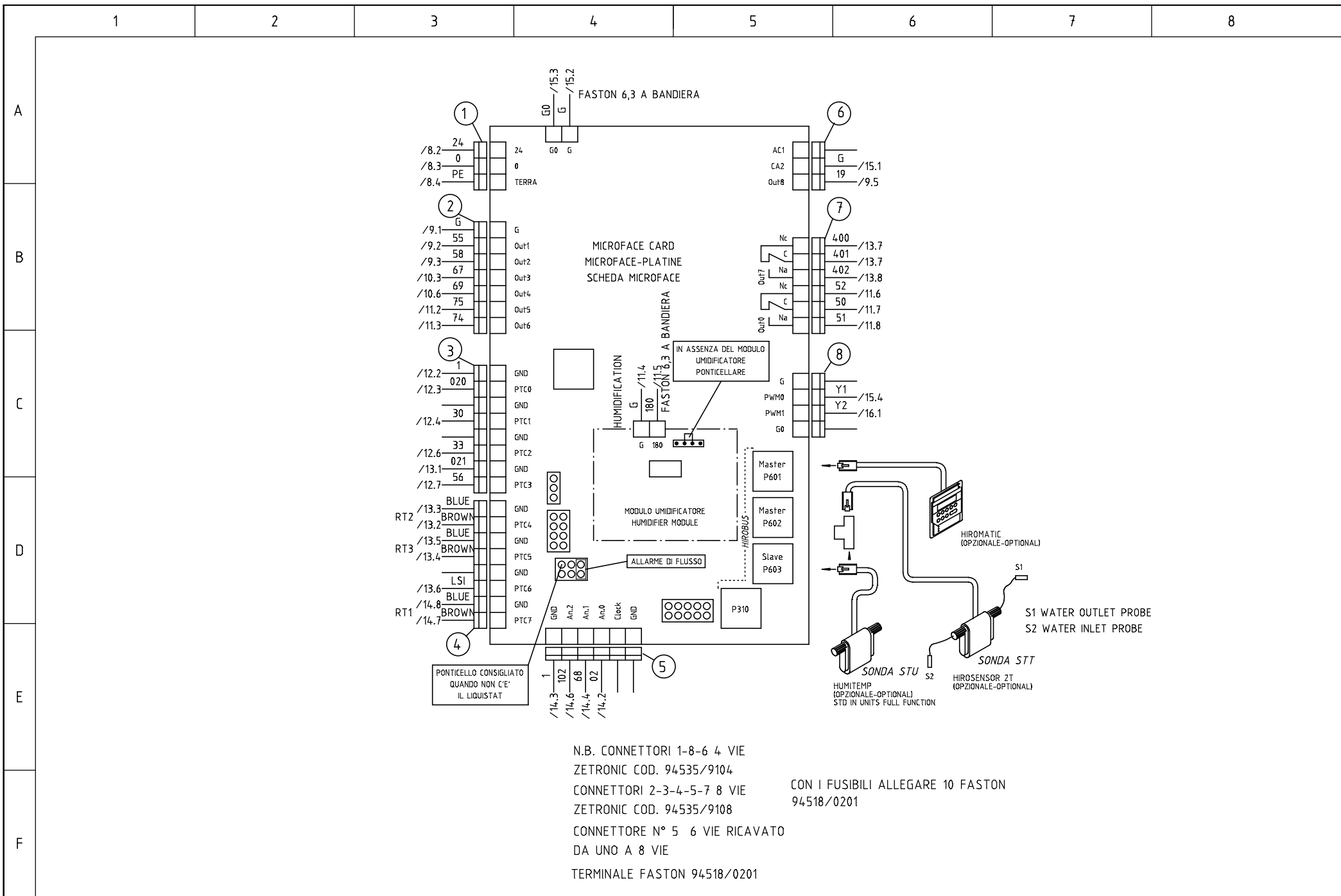

N.B. CONNETTORI 1-8 4 VIE
 ZETRONIC COD. 94535/9104
 CONNETTORI 2-3-4-5-7 8 VIE
 ZETRONIC COD. 94535/9108
 CONNETTORE N° 5 6 VIE RICAIVATO
 DA UNO A 8 VIE
 TERMINALE FASTON 94518/0201

CON I FUSIBILI ALLEGARE 10 FASTON
 94518/0201

c		Date	12.01.2001	Wiring diagram name	Code	F+C+H	400 Vac	50 Hz	
b		Signature	F.A.	CD0105E02-G	317820	TYPE: CP/HIMOD 40 D/F/H	File:	317820	LAYOUT
a		Contr.	G.G.						3 Layout
	Modification	Date	Norm.	EN60204-1	Replaced for:	Replaced by:	Origin:	Sheet 18 of 26	Continue 19

	1	2	3	4	5	6	7	8
A								
B								
C								
D								
E								
F								

	UTENZA	NUMERO	LUNGHEZZA CAVI	TERMIN.	CAVO TIPO NPI
A	COMPRESSORE	UVW.3+PE	4X6mm ² L=3500mm	1 OCCHIELLO ⁰⁵ 1 OCCHIELLO ⁰⁶ PER TERRA	3X6mm2+T CAVO DA COMM.
D	ELETTROV. FREON	057-G	2X1 mm ² L=3400mm		CAVO TIPO NPI
E	HIGH PRESS. P_STAT	055-57	2x1 mm ² L=3700mm		CAVO TIPO NPI
F	TERM.SIC.ST12	023-24	2x1 mm ² L=1000mm	FASTON 6,3	CAVO TIPO NPI
F1	TERM.SIC.ST13	068-023	2x1 mm ² L=1500mm	FASTON 6,3	CAVO TIPO NPI
G	TRASFORMATORE	R3-R4-R5-R20-PE S3-S4-S5-S20 T3-T4-T5-G0-G1	4x1.5mm ² L=1370mm+PE 4x1.5mm ² L=1230mm 5x1.5mm ² L=1080mm	NUMERARE CON ANELLI	PUNTALI 1 OCCHIELLO ⁰⁵ PER TERRA IN CALZA
G1	ALIMENTAZIONE SBU	SL UVW.7+PE	5x2.5mm ² L=3700mm	PUNTALI	1 OCCHIELLO ⁰⁵ PER TERRA 4X2,5mm2+T NPI CAVO DA COMMERCIO
H	YV7	75-G	2x1 mm ² L=3400mm	FASTON 6,3	CAVO TIPO NPI
I	RESIST. CARTER	RS.2+T	2x1.5mm ² +T L=3500mm	PUNTALI	2X1,5mm2+T NPI CAVO DA COMMERCIO
L	LOW PRESS. P_STAT	56-21	2x1 mm ² L=3800mm		CAVO TIPO NPI
M	YV07	74-G	2x1 mm ² L=3400mm	FASTON 6,3	CAVO TIPO NPI
P	VENTILATORE 1	UVW.1+PE	3x1.5mm ² L=3400mm+PE	PUNTALI	3X1,5mm2+T NPI CAVO DA COMMERCIO
Q	VENTILATORE 2	UVW.2+PE	3x1.5mm ² L=3400mm+PE	PUNTALI	3X1,5mm2+T NPI CAVO DA COMMERCIO
Q	KLIXON VENTILATORE 1	054-G1	2 x 1mm ² L=3400mm	PUNTALI	2X1mm2 NPI CAVO DA COMMERCIO
R	KLIXON VENTILATORE 2	056-G1	2 x 1mm ² L=3400mm	PUNTALI	2X1mm2 NPI CAVO DA COMMERCIO
S	SENSORE LSI AUSIL.	1-LS1-V7	3 x 1mm ² L= VEDI POSIZ. QE FORNIRE CABLATO L=150MM	PUNTALI	2 ROSSI+1 NERO
T	PROTEZ. INTEGRALE	57-057-0-24	4x1.5mm ² L=3500mm	FASTON 6,3 A BANDIERA	
U	PSV1 VENTILATORE 1	1-03	2 x 1mm ² L=900mm	FORCINA	2X1mm2 NPI CAVO DA COMMERCIO
V	PSV2 VENTILATORE 2	03-1	2 x 1mm ² L=900mm	FORCINA	2X1mm2 NPI CAVO DA COMMERCIO
W	VALVOLA ACQUA FREDDA	67-69-G	3 x 1mm ² L=3700mm	PUNTALI	3X1mm ² NPI CAVO DA COMMERCIO
X	SCHEDA	Y1-G-G0-068 0500-0501	6X1mm ² L=800mm IN GUAINA	FASTON 6.3 A BANDIERA	

c	Date	12.01.2001	Wiring diagram name		Code	317820	F+C+H	400 Vac	50 Hz			
b	Signature	F.A.	CD0105E02-G							LAYOUT		
a	Contr.	G.G.					TYPE:			3 Layout		
Modification	Date	Date	Norm.	EN60204-1	Replaced for:	Replaced by:	Origin:	CP/HIMOD 40 D/F/H	File:	317820	Sheet 19 of 26	Continue 20

1

2

3

4

5

6

7

8

A

B

C

D

E

F

LCD DISPLAY REAR BACK VIEW

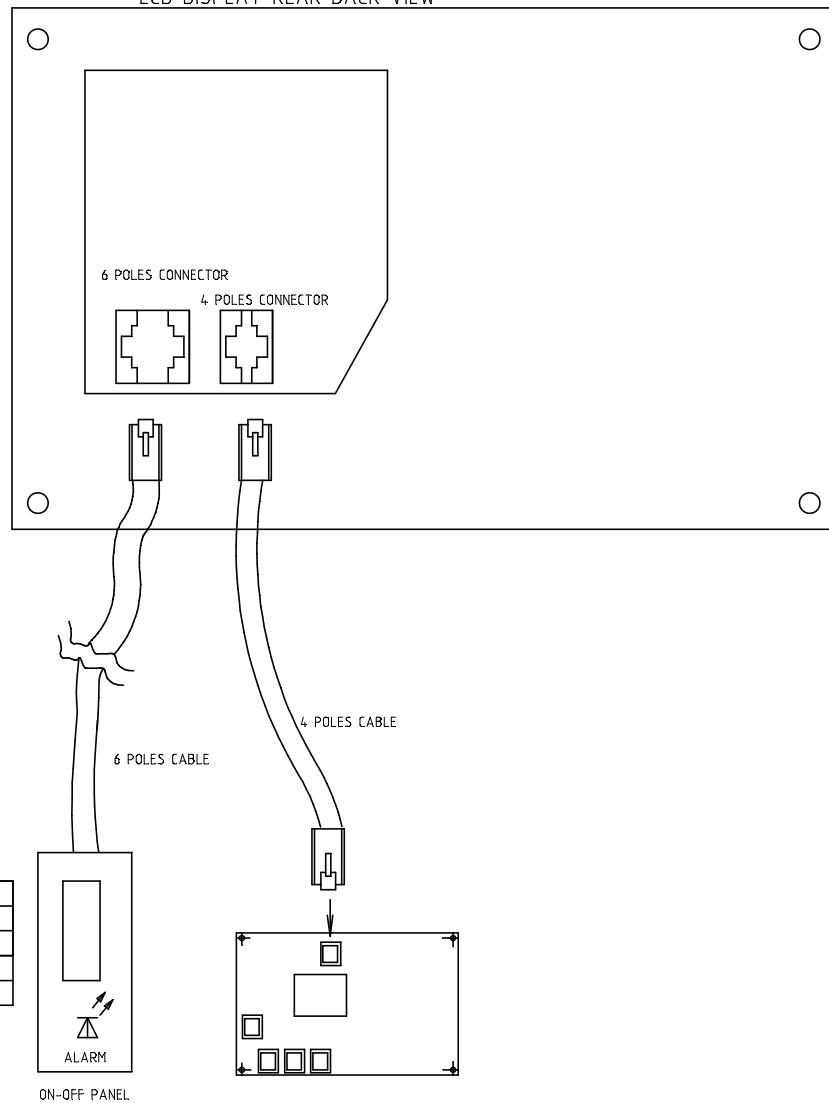

ON-OFF PANEL

LED COLOR	AIR COND. UNIT STATUS
GREEN ON	UNIT OPERATING
RED ON	UNIT IN ALARM
GREEN FLASHING	UNIT IN STAND-BY
ORANGE ON	UNIT POWERED BUT NOT OPERATING

c			Date	12.01.2001		Wiring diagram name	Code	F+C+H	400 Vac	50 Hz		
b			Signature	E.A.		CD0105E02-G	317820				LAYOUT	
a			Contr.	G.G.				TYPE:	CP/HIMOD 40 D/F/H	File:	317820	3 Layout
	Modification	Date	Date	Norm.	EN60204-1	Replaced for:	Replaced by:	Origin:			Sheet 20 of 26	Continue 21

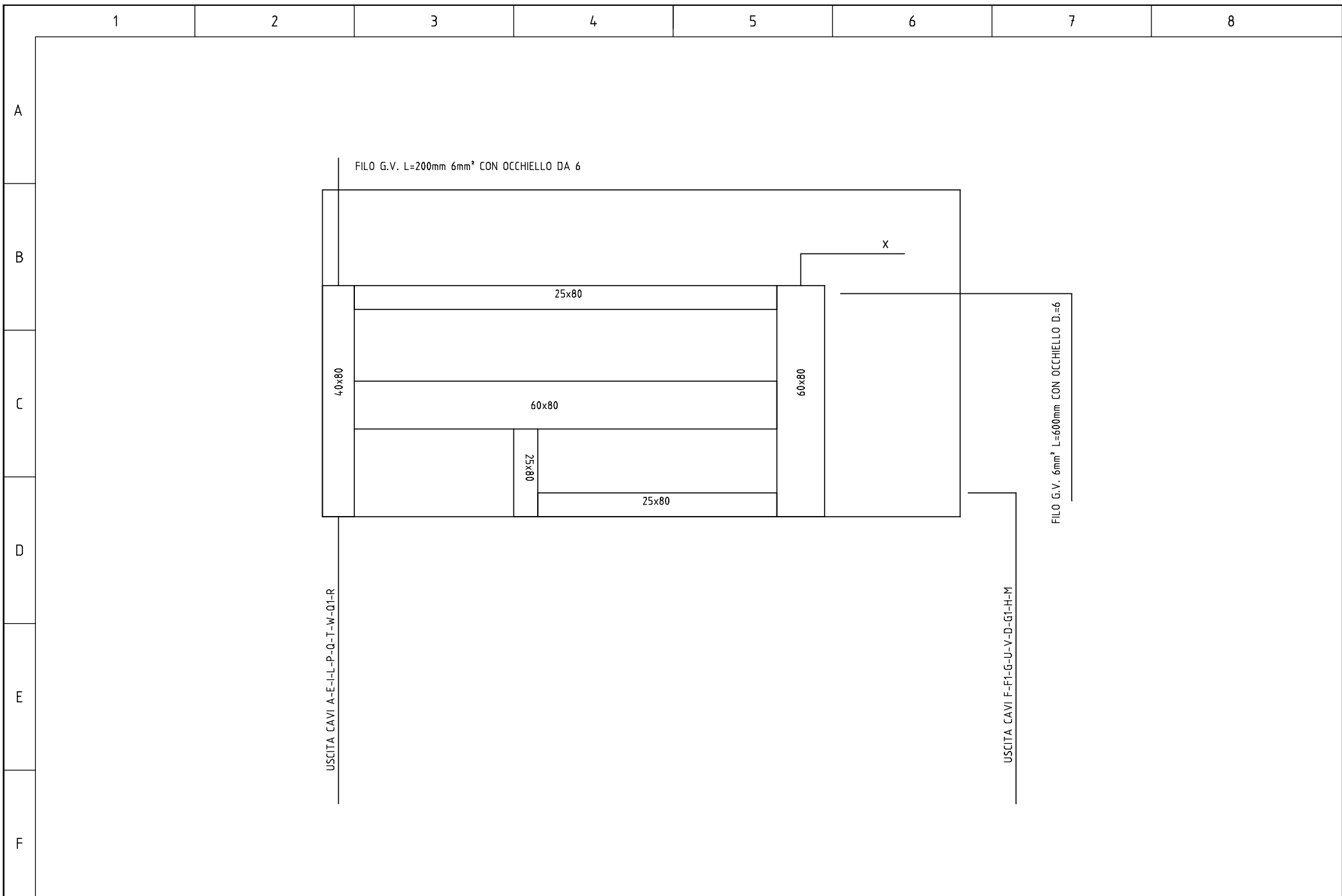

c		Date	12.01.2001	Wiring diagram name	Code	F+C+H	400 Vac	50 Hz			
b		Signature	W.A.	CD0105E02-G	317820				LAYOUT		
a		Contr.	G.G.			TYPE:			3 Layout		
Modification	Date	Date	Norm.	EN60204-1	Replaced for:	Replaced by:	Origin:	CP/HIMOD 40 D/F/H	File: 317820	Sheet 21 of 26	Continue

1		2		3		4		5		6		7		8	
QUANTITY	ARTICLE CODE	DESCRIPTION				TECHNICAL DATA		CATALOGUE NO.	IDENTIFIER	RE.	MANUFACTURER	HIROSS CODE			
A	38	MICROFACE CARD MICROFACE-PLATINE SCHEDA MICROFACE							-A1	/18.3					
		ALARM CARD LARM-KARTE SCHEDA RINVIO ALLARMI							-A2	/16.3					
B		ALARM CARD LARM-KARTE SCHEDA RINVIO ALLARMI							-A3	/16.3					
		FACTOR CORRECTION CAPACITOR KONDENSATOR BLINDSTROMKOMPENSATION CONDENSATORE DI RIFASAMENTO							-C2	/3.3					
C		FACTOR CORRECTION CAPACITOR KONDENSATOR BLINDSTROMKOMPENSATION CONDENSATORE DI RIFASAMENTO							-C3	/4.2					
		FACTOR CORRECTION CAPACITOR KONDENSATOR BLINDSTROMKOMPENSATION CONDENSATORE DI RIFASAMENTO							-C4	/4.6					
D		CLOGGED FILTER ALARM FILTERWARNUNG ALLARME FILTRI SPORCHI							-CF	/12.6					
		FREECOOLER/DUAL FLUID VALVE FREECOOLER/DUAL-FLUID-VENTIL VALVOLA FREECOOLER/DUAL FLUID							-CWMV	/10.5					
E		1st STEP ELECTRIC HEAT. ELEKTROHEIZUNG 1. STUFE RISC. ELETTR. 1° GRADINO							-EH5	/5.3					
		2nd STEP ELECTRIC HEAT. ELEKTROHEIZUNG 2. STUFE RISC. ELETTR. 2° GRADINO							-EH6	/5.5					
F		HOT WATER VALVE HEISSWASSERVENTIL VALVOLA ACQUA CALDA							-HWV	/15.7					
		CONDENSING UNIT SUPPLY VERFLÜSSIGER STROMVERSORGUNG ALIMENTAZIONE UNITA' CONDENSANTE							-M1	/3.6					
F		ALARM CARD LARM-KARTE SCHEDA RINVIO ALLARMI							-N1	/15.4					
		FAN 1 DIFF. PRESSURE SWITCH DIFFERENTIALDRUCKSCHALTER VENTILATOR 1 PRESSOSTATO DIFF. VENTIL. 1							-PSV1	/14.1					
		FAN 2 DIFF. PRESSURE SWITCH DIFFERENTIALDRUCKSCHALTER VENTILATOR 2 PRESSOSTATO DIFF. VENTIL. 2							-PSV2	/14.2					
c		Date	12.01.2001		Wiring diagram name		Code	F+C+H		400 Vac 50 Hz		COMPONENT LIST			
b		Signature	E.A.		CD0105E02-G		317820	TYPE:		CP/HIM00 40 D/F/H		4 Lista componenti			
a		Contr.	E.G.		Replaced by:		Replaced by:	Origin:	File:	317820		Sheet 22 of 26 Continue 23			

1		2		3		4		5		6		7		8	
QUANTITY	ARTICLE CODE	DESCRIPTION				TECHNICAL DATA		CATALOGUE NO.	IDENTIFIER	RE.	MANUFACTURER	HIROSS CODE			
A		WATER INLET PROBE FÜHLER WASSEREINTRITT SONDA INGRESSO ACQUA							-RT2	/13.2					
		OUTER AIR TEMPERATURE PROBE AUSSENTEMP. FÜHLER SONDA TEMPERATURA ARIA ESTERNA							-RT3	/13.4					
B		REMOTE ON/OFF EXTERN EIN-AUS ON/OFF REMOTO							-S1	/12.3					
		USER 1 INPUT BENUTZEREINGANG 1 INGRESSO UTENTE 1							-S2	/12.4					
		HEATER SAFETY THERMOSTAT HEIZUNGS-SICHERHEITSTHERMOSTAT THERMOSTATO SIC. RES. ELETTRICHE							-ST12	/15.8					
C		HEATER SAFETY THERMOSTAT HEIZUNGS-SICHERHEITSTHERMOSTAT THERMOSTATO SIC. RES. ELETTRICHE							-ST13	/15.8					
		WATER INLET PROBE FÜHLER WASSEREINTRITT SONDA INGRESSO ACQUA							-ST14	/13.5					
D		HUMIDIFIER CURRENT TRANSFORMER STROMWANDLER BEFEUCHTER TRASFORMATORE DI CORRENTE UMIDIFICATORE							-TA	/6.4					
		FREON SOLENOID VALVE MAGNETVENTIL-KÄLTEMITTEL ELETTROVALVOLA FREON							-YV1	/9.3					
		HOT GAS SOLENOID VALVE HEISSGASMAGNETVENTIL ELETTROVALVOLA GAS CALDO							-YV5	/15.7					
E		HUMIDIFIER CHARGE SOLENOID VALVE MAGNETVENTIL-BEFEUCHTEREINSPEISUNG ELETTROVALVOLA CARICO UMIDIFICATORE							-YV7	/11.2					
		HUMIDIFIER DRAIN SOLENOID VALVE MAGNETVENTIL-BEFEUCHTERENTLEERUNG ELETTROVALVOLA SCARICO UMIDIFICATORE							-YV07	/11.3					
F		CRANKCASE HEATER KURBELWANNENHEIZUNG RESISTENZA CARTER							-EH3	/7.2					
		HUMIDIFIER BEFEUCHTER UMIDIFICATORE							-EH7	/6.3					
		FAN 1 VENTILATOR 1 VENTILATORE 1							-EV1	/4.3					

c		Date	12.01.2001	Wiring diagram name		Code	F+C+H		400 Vac 50 Hz		COMPONENT LIST	
b		Signature	E.A.	CD0105E02-G		317820	TYPE:		CP/HIM00 40 D/F/H		4 Lista componenti	
a		Contr.	G.G.	Replaced for:			Replaced by:		Origin:		File: 317820	
Modification		Date	Date	Norm.	EN60204-1	Replaced for:		Replaced by:		Origin:		Continue 24

1		2		3		4		5		6		7		8	
QUANTITY	ARTICLE CODE	DESCRIPTION				TECHNICAL DATA		CATALOGUE NO.	IDENTIFIER	RE.	MANUFACTURER	HIROSS CODE			
A		FAN 2 VENTILATOR 2 VENTILATORE 2							-EV2	/4.7					
		FAN 1 INNER KLIXON KLIXON VENTILATOR 1 KLIXON INTERNO VENTILATORE 1							-FR1	/9.4					
		FAN 2 INNER KLIXON KLIXON VENTILATOR 2 KLIXON INTERNO VENTILATORE 2							-FR2	/9.7					
B		LOW PRESSURE SWITCH NIEDERDRUCKSCHALTER PRESSOSTATO DI BASSA PRESSIONE							-LP	/13.1					
		COMPRESSOR VERDICHTER COMPRESSORE							-M3	/3.4					
C		INTEGRAL PROTECT. FOR COMP. 1 INNERER MOTORSCHUTZ VERDICHTER 1 PROTEZ. INTEGRALE COMP. 1							-PI	/7.6					
		AIR SUCTION TEMP. PROBE TEMPERATURFÜHLER LUFTANSAUG SONDA DI TEMP. ASP. ARIA							-RT1	/14.7					
		LEVEL PROBE WASSERSTANDSFÜHLER SENSORE DI LIVELLO							-SL	/6.4					
D	4	HS05.11	FAN 1 CONTACTOR VENTILATORMOTOR SCHÜTZ Nr 1 CONTATTORE VENTILATORE 1		1NA+1NC		HS05.11	-KM1	/9.4	AEG	256027				
			DE-HUMIDIFICATION CONTACTOR SCHÜTZ ENTFEUCHTUNG CONTATTORE DEUMIDIFICAZIONE		1NA+1NC		HS05.11	-KM1A	/9.5	AEG	256027				
E			FAN 2 CONTACTOR VENTILATORMOTOR SCHÜTZ Nr 2 CONTATTORE VENTILATORE 2		1NA+1NC		HS05.11	-KM2	/9.7	AEG	256027				
			DE-HUMIDIFICATION CONTACTOR SCHÜTZ ENTFEUCHTUNG CONTATTORE DEUMIDIFICAZIONE		1NA+1NC		HS05.11	-KM2A	/9.8	AEG	256027				
	1	LSI	LEVEL PROBE WASSERSTANDSFÜHLER SENSORE DI LIVELLO		LSI		275905	-LSI	/6.5	HIROSS	275905				
F	1	LWD	FLOODING ALARM ALARM WASSERAUSTRITT ALLARME ALLAGAMENTO		LWD			-R	/14.6	HIROSS	275180				
	1	MKPC44/2	ANTI-NOISE FILTER ENTSTÖRFILTER FILTRO ANTIDISTURBO		MKPC44/2		MKPC44/2	-C5	/7.4	ARCOTRONICS	254324				
c			Date	12.01.2001	Wiring diagram name		Code	F+C+H		400 Vac 50 Hz		COMPONENT LIST			
b			Signature	#.A.	CD0105E02-G										
a			Contr.	G.G.			317820	TYPE:		CP/HIMOD 40 D/F/H		4 Lista componenti			
Modification	Date	Date	Norm.	EN60204-1	Replaced for:	Replaced by:	Origin:	File:		317820		Sheet 24 of 26 Continue 25			

1		2		3		4		5		6		7		8	
QUANTITY	ARTICLE CODE	DESCRIPTION				TECHNICAL DATA		CATALOGUE NO.	IDENTIFIER	RE.	MANUFACTURER	HIROSS CODE			
A	1	MKT1-43	ANTI-NOISE FILTER ENTSTÖRFILTER FILTRO ANTIDISTURBO				MKT1-43		0,5microF 100ohm	-SSF	/9.2	ARCOTRONIC	254656		
	1	RESISTENZA 2,2K	RESISTOR WIDERSTAND RESISTENZA				149-739 2,2K		149-739	-R1	/13.1	RS	255993		
	1	SF520263	AUXILIARY FUSE 24 V SICHERUNG STEUERSTROMKREIS 24 V FUSIBILE AUSILIARI 24V				6.3A F		SF520263	-FU1	/7.4	OMEGA	254731		
B	1	TK80 4P 0T63E4	MAIN SWITCH HAUPTSCHALTER INTERRUPTORE GENERALE				80A 4 POLI		19114SM 0T63E4	-QS	/3.2	TECHNOELECTRIC ABB	255043		
	2	VB05	DE-HUMIDIFICATION CONTACTOR SCHÜTZ ENTFEUCHTUNG CONTATTORE DEUMIDIFICAZIONE				VB05		VB05	-KM1A	/9.5	AEG	256139		
			DE-HUMIDIFICATION CONTACTOR SCHÜTZ ENTFEUCHTUNG CONTATTORE DEUMIDIFICAZIONE				VB05		VB05	-KM2A	/9.8	AEG	256139		
C	1	51AT40K	FAN/S AUTOTRANSFORMER REGELTRAFO FÜR VENTILATOREN AUTOTRASFORMATORE VENTILATORE/I				6,7KVA		51AT40K	-TM	/4.3	MARINI	256299		
	1	51TM2VM	TRANSFORMER TRANSFORMATOR TRASFORMATORE				160VA		51TM2VM	-TC	/7.4	MARINI	255769		
D	1	115 131.06+F6,3F	AUXILIARY FUSE 24 V SICHERUNG STEUERSTROMKREIS 24 V FUSIBILE AUSILIARI 24V				M4/8.SF GRIGIO		115 131.06	-FU1	/7.4	ENTRELEC	255716		
	1	831-820-676 24267	TRANSF. AUTOMATIC SWITCH AUTOMATIK-SCHALTER INTERR. AUTOMATICO TRASFORMATORE				6A 6KA		E82 C 6 24267	-QF8	/7.2	AEG MERLIN GERIN	255048		
	1	831-820-678 24268	CONDENSING UNIT AUTOMATIC SWITCH AUTOMATIKSCHALTER VERFLÜSSIGEREINHEIT INTERRUPTORE AUTOM. UNITA' CONDENSANTE				10A 6KA		E82 C 10 24268	-QF9	/3.6	AEG MERLIN GERIN	255067		
E	1	831-830-493 25134	COMPRESSOR AUTOMATIC SWITCH AUTOMATIKSCHALTER VERDICHTER INTERRUPTORE AUTOMATICO COMPRESSORE				32A 6KA		E83 D32 25134	-QF3	/3.4	AEG MERLIN GERIN	256162		
	1	831-830-678 24282	FAN AUTOMATIC SWITCH AUTOM. VENTILATORSCHALTER INTERRUPTORE AUTOM. VENTILATORE				10A 6KA		E83 C10 24282	-QF1	/4.3	AEG MERLIN GERIN	255073		
	1	831-830-680 24284	HUMIDIFIER AUTOM. SWITCH AUTOM. SCHALTER BEFEUCHTER INTERR. AUTOM. UMIDIFICATORE				16A 6KA		E83 C16 24284	-QF7	/6.3	AEG MERLIN GERIN	255062		
F	1	831-830-681 24285	HEATER AUTOM. SWITCH AUTOM. SCHALTER HEIZUNG INTERR. AUTOM. RESISTENZE				20A 6KA		E83 C20 24285	-QF5	/5.3	AEG MERLIN GERIN	255069		
c			Date	12.01.2001		Wiring diagram name		Code	F+C+H		400 Vac 50 Hz		COMPONENT LIST		
b			Signature	#A.		CD0105E02-G		317820	TYPE:		CP/HIMOD 40 D/F/H		4 Lista componenti		
a			Contr.	G.G.					File:		317820		Sheet 25 of 26 Continue 26		
	Modification	Date	Date	Norm.	EN60204-1		Replaced for:	Replaced by:	Origin:						

1		2		3		4		5		6		7		8	
QUANTITY	ARTICLE CODE	DESCRIPTION				TECHNICAL DATA		CATALOGUE NO.	IDENTIFIER	RE.	MANUFACTURER	HIROSS CODE			
A	1	910-301-562-55	COMPRESSOR CONTACTOR VERDICHTER SCHÜTZ CONTATTORE COMPRESSORE				24V AC, 1NA+1NC	LS27.11	-KM3	/9.2	AEG	256042			
	2	910-302-503-55 LC1D12B7	ELECTR. HEAT. CONTACTOR 2 ELEKTROHEIZUNG SCHÜTZ 2 CONTATTORE RISC. ELETTR. 2				24V AC, 1NA	LS7.10 LC1D12B7	-KM5	/15.5	AEG TELEMECANIQUE	256038			
B		LC1D12B7	ELECTR. HEAT. CONTACTOR 1 ELEKTROHEIZUNG SCHÜTZ 1 CONTATTORE RISC. ELETTR. 1				24V AC, 1NA	LS7.10 LC1D12B7	-KM6	/15.4	AEG TELEMECANIQUE	256038			
	1	910-302-623-55 LC1D09B7	HUMIDIFIER CONTACTOR BEFEUCHTER SCHÜTZ CONTATTORE UMIDIFICATORE				24V AC, 1NA	LS4.10 LC1D09B7	-KM7	/11.5	AEG TELEMECANIQUE	255585			
	2	910-303-001-55+4+1	DE-HUMIDIFICATION CONTACTOR SCHÜTZ ENTFEUCHTUNG CONTATTORE DEUMIDIFICAZIONE				24V AC 50-60, 2NA+2NC+INTERBLO	LS05.10	-KM1A	/9.5	AEG	256026			
C			DE-HUMIDIFICATION CONTACTOR SCHÜTZ ENTFEUCHTUNG CONTATTORE DEUMIDIFICAZIONE				24V AC 50-60, 2NA+2NC+INTERBLO	LS05.10	-KM2A	/9.8	AEG	256026			
	2	910-303-001-55-4AUS	FAN 1 CONTACTOR VENTILATORMOTOR SCHÜTZ Nr 1 CONTATTORE VENTILATORE 1				24V AC 50-60, 2NA+2NC	LS05.10	-KM1	/9.4	AEG	256026			
			FAN 2 CONTACTOR VENTILATORMOTOR SCHÜTZ Nr 2 CONTATTORE VENTILATORE 2				24V AC 50-60, 2NA+2NC	LS05.10	-KM2	/9.7	AEG	256026			
D	1	19501 OHY2AJ	MAIN SWITCH HAUPTSCHALTER INTERRUTTORE GENERALE				19501	19501 OHY2AJ	-QS	/3.2	TECHNOELECTRIC ABB	256994			
	1	19535-100 OX55X120	MAIN SWITCH HAUPTSCHALTER INTERRUTTORE GENERALE				19535-100	19535-100 OX55X120	-QS	/3.2	TECHNOELECTRIC ABB	255494			
E															
F															

c			Date	12.01.2001	Wiring diagram name			Code	F+C+H			400 Vac 50 Hz		COMPONENT LIST	
b			Signature	E.A.	CD0105E02-G			317820	TYPE:			4 Lista componenti			
a	Modification	Date	Date	Norm.	EN60204-1	Replaced for:	Replaced by:	Origin:	CP/HIMOD 40 D/F/H			File:	317820	Sheet 26 of 26 Continue	

1

2

3

4

5

6

7

8

A

REVISION INDEX

Revision date	REVISION INDEX	Description	Signature
03/09/98	G	AGGIORNATO TABELLA CAVI E PLANIMETRIA	T.A.

B

C

D

E

F

c	Date	12.01.2001	Wiring diagram name	Code	F+C+H	400 Vac	50 Hz	COMPONENT LIST	
b	Signature	T.A.	CD0105E02-G	317820					
a	Contr.	G.G.			TYPE:	CP/HIMOD 40 D/F/H	File: 317820		5 revisioni
Modification	Date	Date	Norm.	EN60204-1	Replaced for:	Replaced by:	Origin:	Sheet 25 of 26	Continue