

DOSSIER MECANIQUE & FRIGORIFIQUE MECHANICAL & REFRIGERATION FILE

Index/Index	Date	Norm/Name	Modifications



MCSB 422 S K

Dessiné/Drawn by:
R. PETREQUIN

Date:
14/12/2007

Mod.	.	.	.
Date	.	.	.
Norm	.	.	.

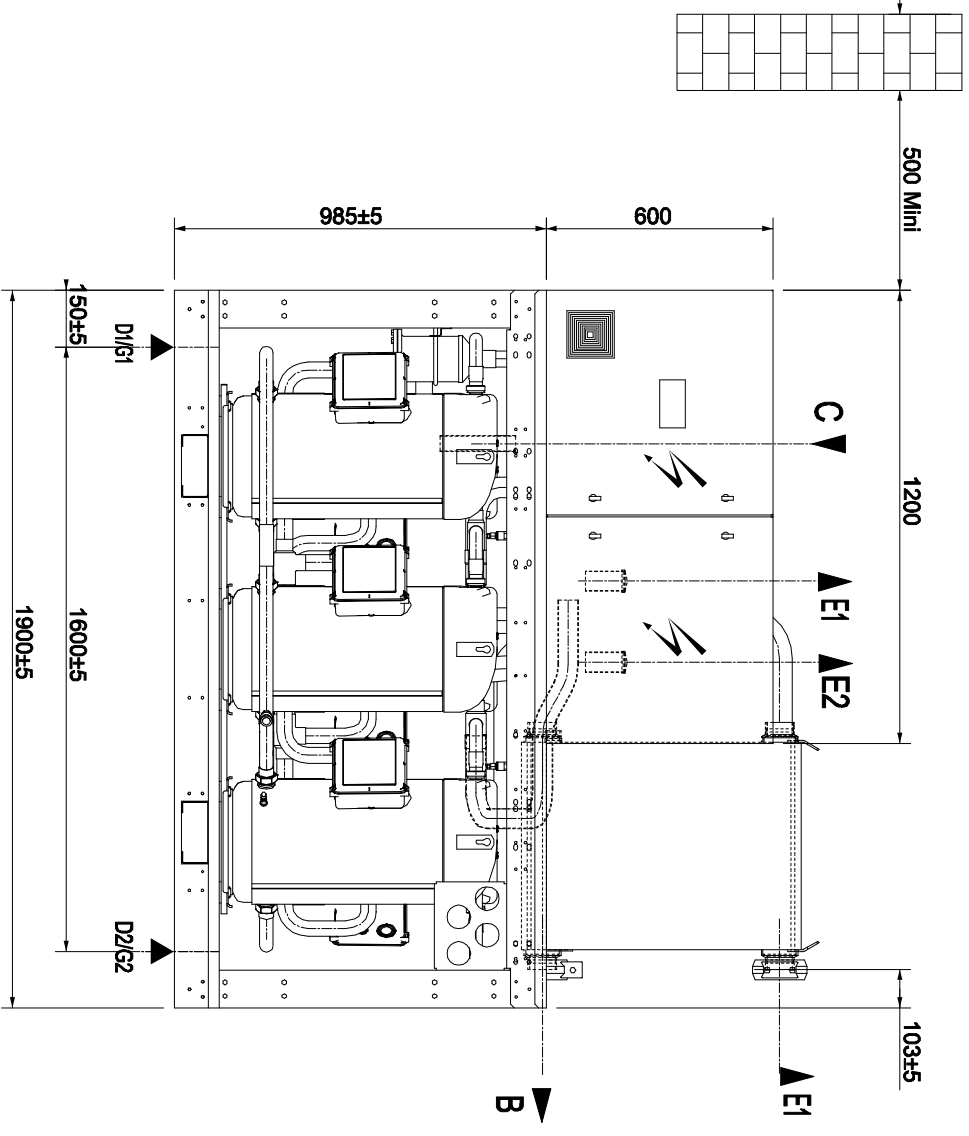
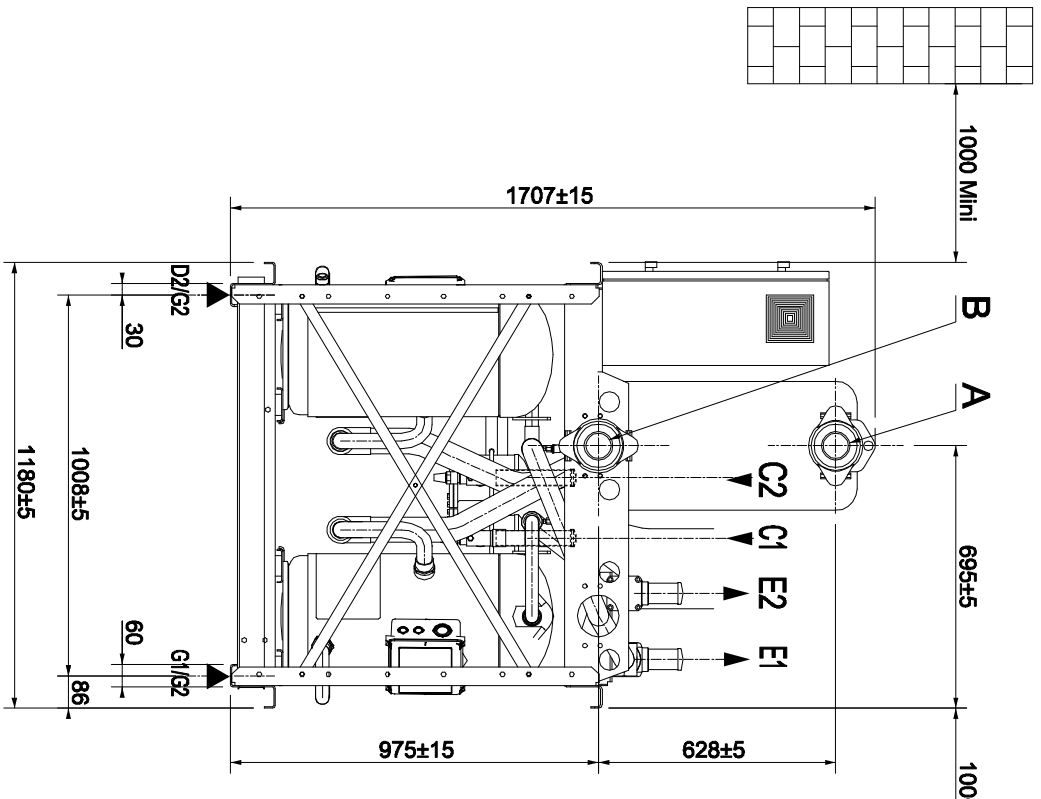

PLAN D'ENSEMBLE

Dessinateur : RF	Ech : 7/100	Date : 16/03/07	2/6
MCSB-422-SK			

RACCORDEMENT HYDRAULIQUE WATER CONNECTION

A	ENTREE / SORTIE EAU FROIDE CHILLED WATER INLET / OUTLET	Victaulic Ø 4"
B	ENTREE / SORTIE EAU CHAUDE HOT WATER INLET / OUTLET	
E1	DEPART FLUIDE FRIGORIGENE / REFRIGERANT FLUID OUTLET	Ø 2" 1/8
E2	RETOUR FLUIDE FRIGORIGENE / REFRIGERANT FLUID INLET	Ø 2" 1/8
C1	INJECTION GAZ CHAUD / HOT GAS	Ø 1" 5/8
C2	INJECTION GAZ CHAUD / HOT GAS	Ø 1" 5/8
V	VIDANGE / DRAINING	Taraudee Ø Threaded PDG GAS

REPARTITION DE CHARGE / LOAD DISTRIBUTION

POIDS DE LA MACHINE A VIDE : 1800 kg
NET UNIT WEIGHT

POIDS DE LA MACHINE EN SERVICE : 1840 kg
OPERATING WEIGHT OF UNIT

- 4 trous de fixation au sol Ø 20
- 4 fixing holes Ø 20

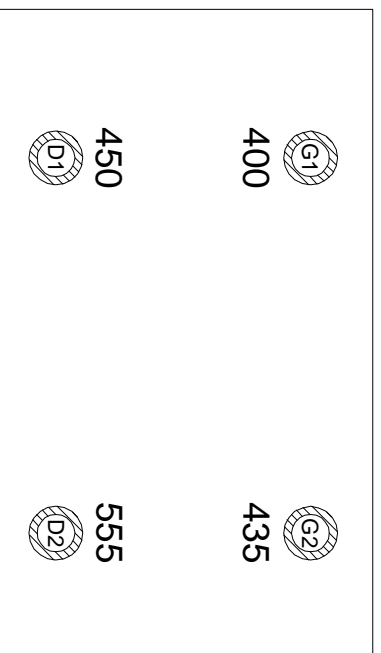

ENCOMBREMENT DES ACCESSOIRE(S) LIVRE(S) DEMONTE(S) DIMENSIONS OF ACCESSORIES SHIPPED KNOCKED DOWN

Le type de raccordement est celui mentionné dans la fenêtre de gauche
The type of connection is indicated in the box on the left

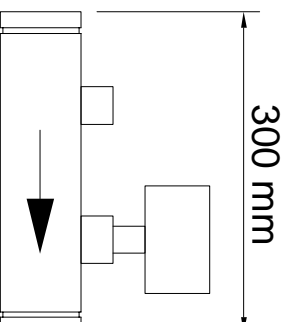

CONTROLEUR DE
DEBIT ET/OU SONDE
FLOW SWITCH
AND/OR SENSOR OF
TEMPERATURE

ENTREE DU CABLE DE RACCORDEMENT PUISSANCE
POWER SUPPLY INLET

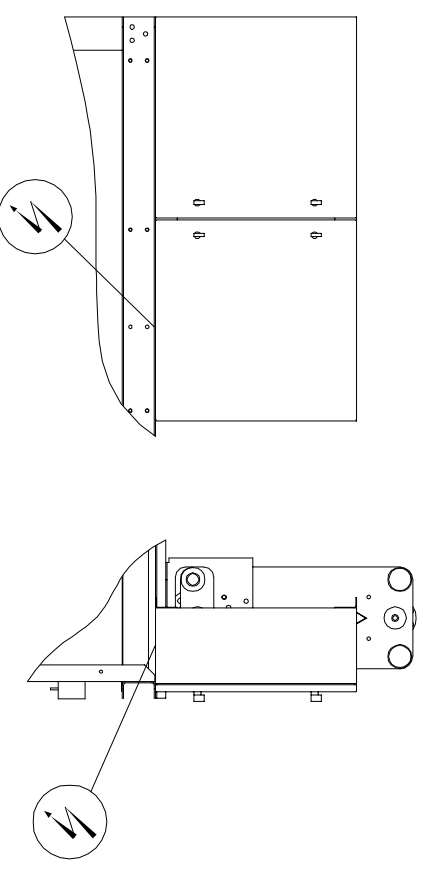

INSTALLATION & RACCORDEMENT MACHINE

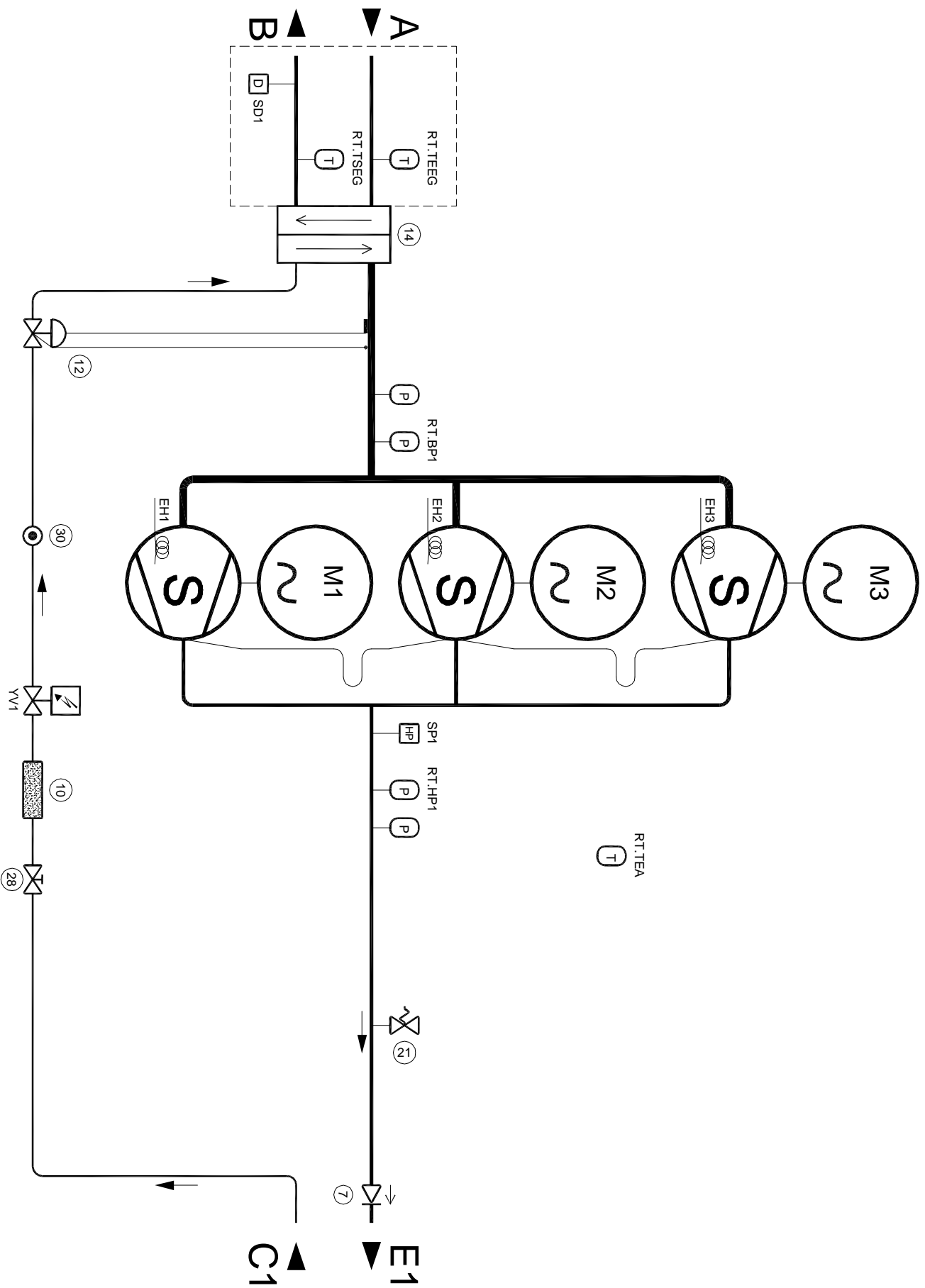







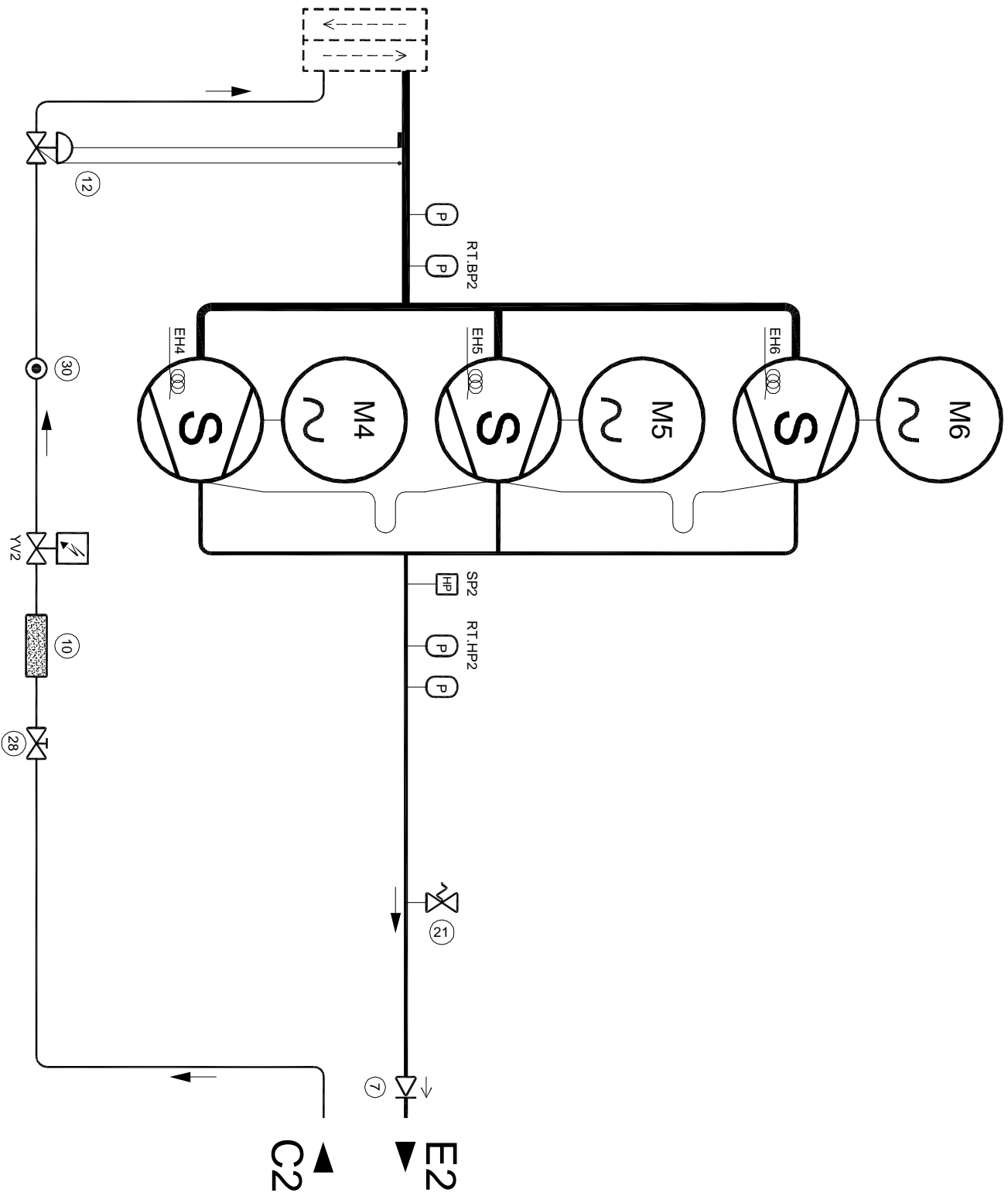











----- Livré non monté / Delivered not mounted

SCHEMA FRIGORIFIQUE

Indice	Date	Norm	Modifications



SCHEMA FRIGORIFIQUE (circuit 2)

1	Antivibratie Vibration isolators	16	Economiseur Economiser	31	Vase d'expansion Expansion tank		Compresseur a piston Reciprocating compressor		Pressostat combiné BP + HP Combine HP-LP switch
2	Bac a eau Water pan	17	Diaphragme Diaphragm	32	Vanne de réglage Regulating valve		Compresseur scroll Scroll compressor		Vanne commandé par pression Pressure operated valve
3	Boutelle anti-coup de liquide Anti-slugging receiver	18	Echangeurs divers Miscellaneous exchangers	33	Vanne de vidange Drain valve		Compresseur a vis Screw compressor		Vanne a commande électrique Electrically operated valve
4	Boutelle reservoir Receiver	19	Purgeur d'air Air purges	34	Disconnecteur Disconnecter		Pompe Pump		Résistance Heater
5	Vanne de remplissage Filling valve	20	Silencieux de refoulement Discharge silencer	35	Boutelle compensatrice Compensating tank		Moteur Motor		
6	Clapet de decharge eau Water discharge valve	21	Soupape de securite Safety valve	36	Vanne de tarionnage manometre Pressure gauge setting valve		Controlleur de débit Flow switch		
7	Clapet de retenue Retaining valve	22	Separateur d'huile Oil separator	37	D'iente par capillaire Capillary expansion system		Controlleur de niveau Level controller		
8	Condenseur a air Air cooled condenser	23	Vanne 3 voies 3-way valve				Controlleur de pression Pressure controller		
9	Condenseur a eau Water cooled condenser	24	Vanne 4 voies 4-way valve				Controlleur de température Temperature controller		
10	Deshydrateur Drier	25	Vanne aspiration compresseur Compressor suction valve				Indicateur de niveau Level indicator		
11	Dentendeur électronique Electronic expansion valve	26	Vanne refoulement compresseur Compressor discharge valve				Indicateur de pression Pressure indicator		
12	Detendeur thermostatique Thermostatic expansion valve	27	Vanne pressostatique Pressure operated valve				Indicateur de température Temperature indicator		
13	Filtre Filter	28	Vanne a main Manual valve				Pressostat basse pression Low pressure switch		
14	Evaporateur a eau Water evaporator	29	Evaporateur a air Air cooled evaporator				Pressostat haute pression High pressure switch		
15	Vidange Drain	30	Voyant liquide Liquid sightglass				Pressostat d'huile Oil pressure switch		

MANUTENTION - HANDLING

POIDS

1800 kg

WEIGHT

