

# DOSSIER MECANIQUE & FRIGORIFIQUE MECHANICAL & REFRIGERATION FILE

Index/Index	Date	Norm/Name	Modifications



MCC 132 S K LN LENNOX UK	Dessiné/Drawn by: R. PETREQUIN Date: 30/05/2006	DM132982	1/8
-----------------------------	--	----------	-----

Ref	RF	EVAP TBE1373H
Date	30/106	
Mod		

Modification	
--------------	--

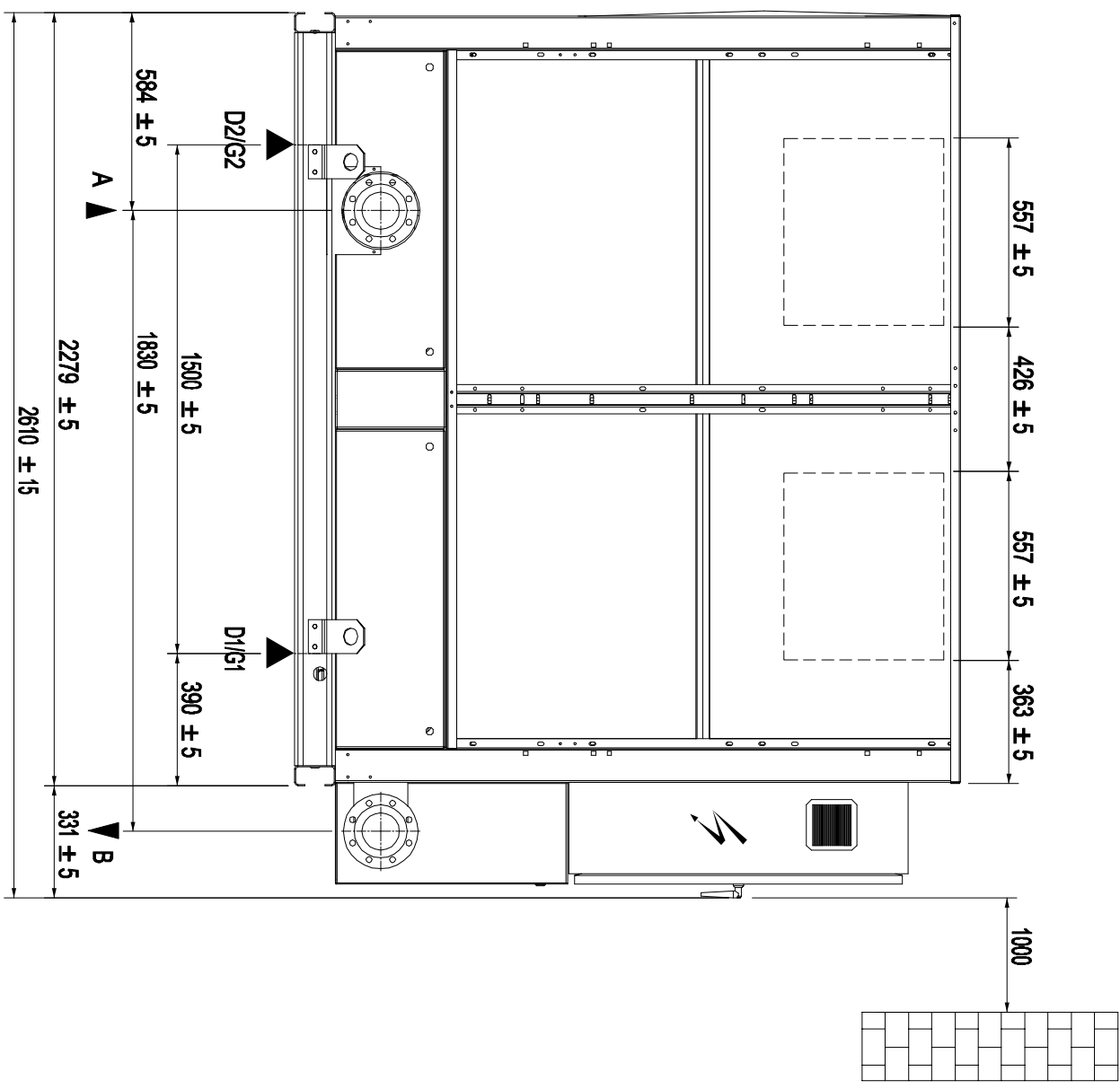
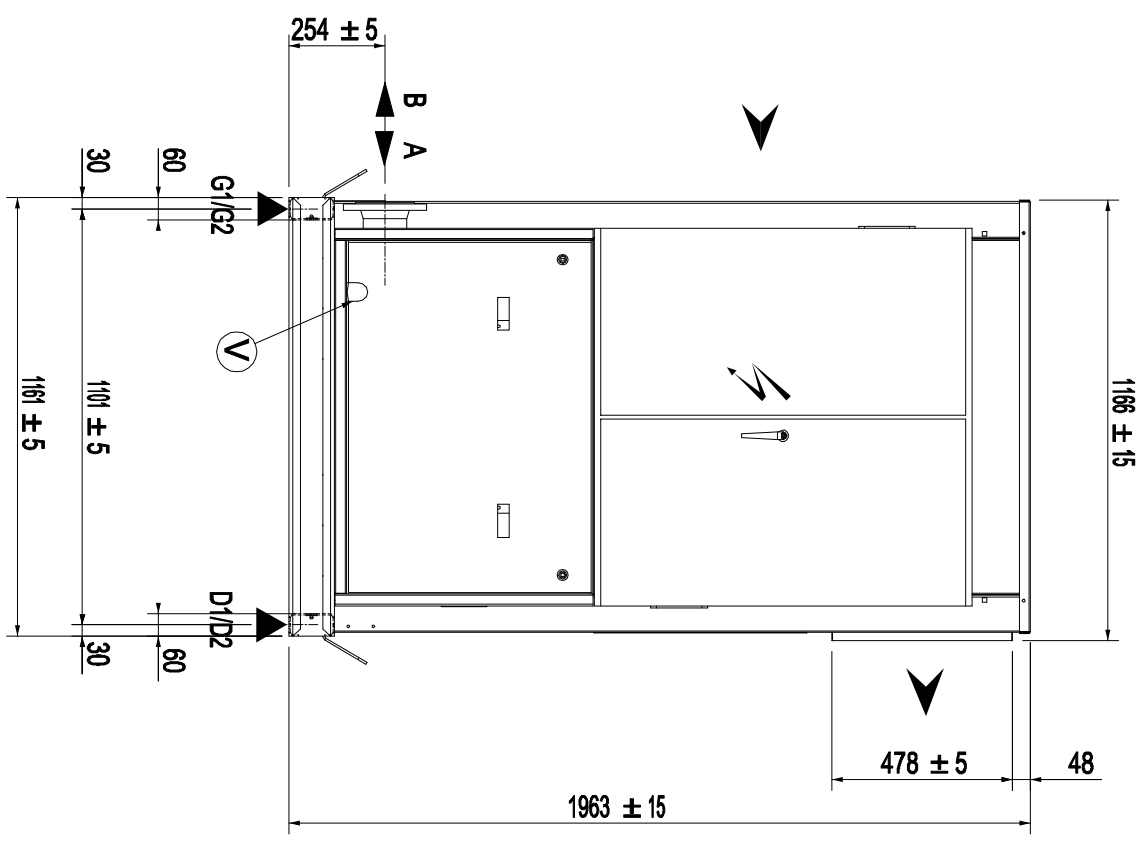

# PLAN D'ENSEMBLE

Dessinateur : PB	Ech : 7/100	Date : 17/02/06	2/8
MCC4S02C0000000P006			

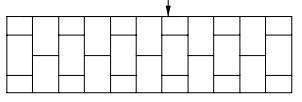

## RACCORDEMENT HYDRAULIQUE WATER CONNECTION

A	ENTREE / SORTIE EAU FROIDE	Bride DN100 PN16
B	CHILLED WATER INLET / OUTLET	
	ENTREE / SORTIE EAU CHAUDE	
	HOT WATER INLET / OUTLET	
	DEPART FLUIDE FRIGORIGENE / REFRIGERANT FLUID OUTLET	Ø
	RETOUR FLUIDE FRIGORIGENE / REFRIGERANT FLUID INLET	Ø
	INJECTION GAZ CHAUD / HOT GAS	Ø
V	VIDANGE DRAINING	Ø21.3 Taraudee Threaded Ø 1/2" PDG GAS

## REPARTITION DE CHARGE / LOAD DISTRIBUTION

POIDS DE LA MACHINE A VIDE : 1392 kg  
NET UNIT WEIGHT

POIDS DE LA MACHINE EN SERVICE : 1435 kg  
OPERATING WEIGHT OF UNIT

- 4 trous de fixation au sol Ø 20
- 4 fixing holes Ø 20

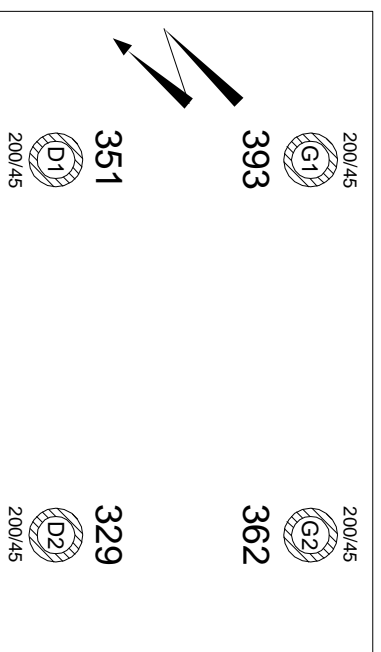

## ENCOMBREMENT DES ACCESSOIRE(S) LIVRE(S) DEMONTE(S) DIMENSIONS OF ACCESSORIES SHIPPED KNOCKED DOWN

Le type de raccordement est celui mentionné dans la fenêtre de gauche  
The type of connection is indicated in the box on the left

## ENTREE DU CABLE DE RACCORDEMENT PUISSANCE POWER SUPPLY INLET

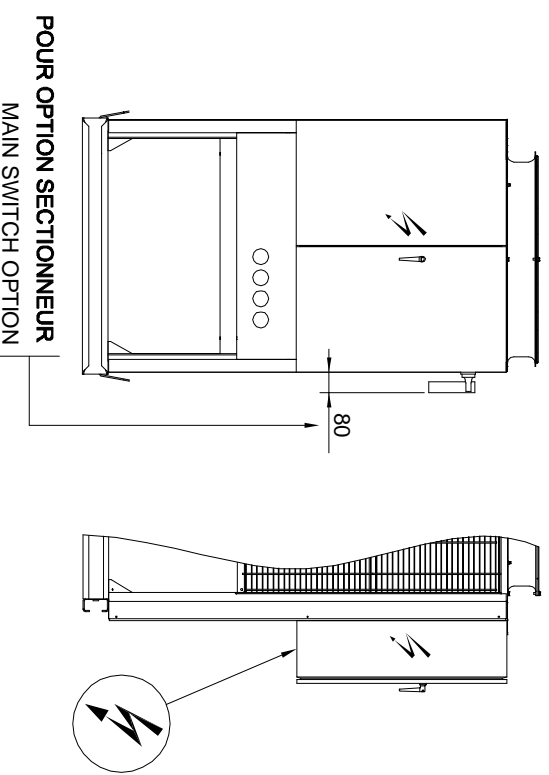

## INSTALLATION & RACCORDEMENT MACHINE

**DIMENSION DE RACCORDEMENT D'ENTREE D'AIR**

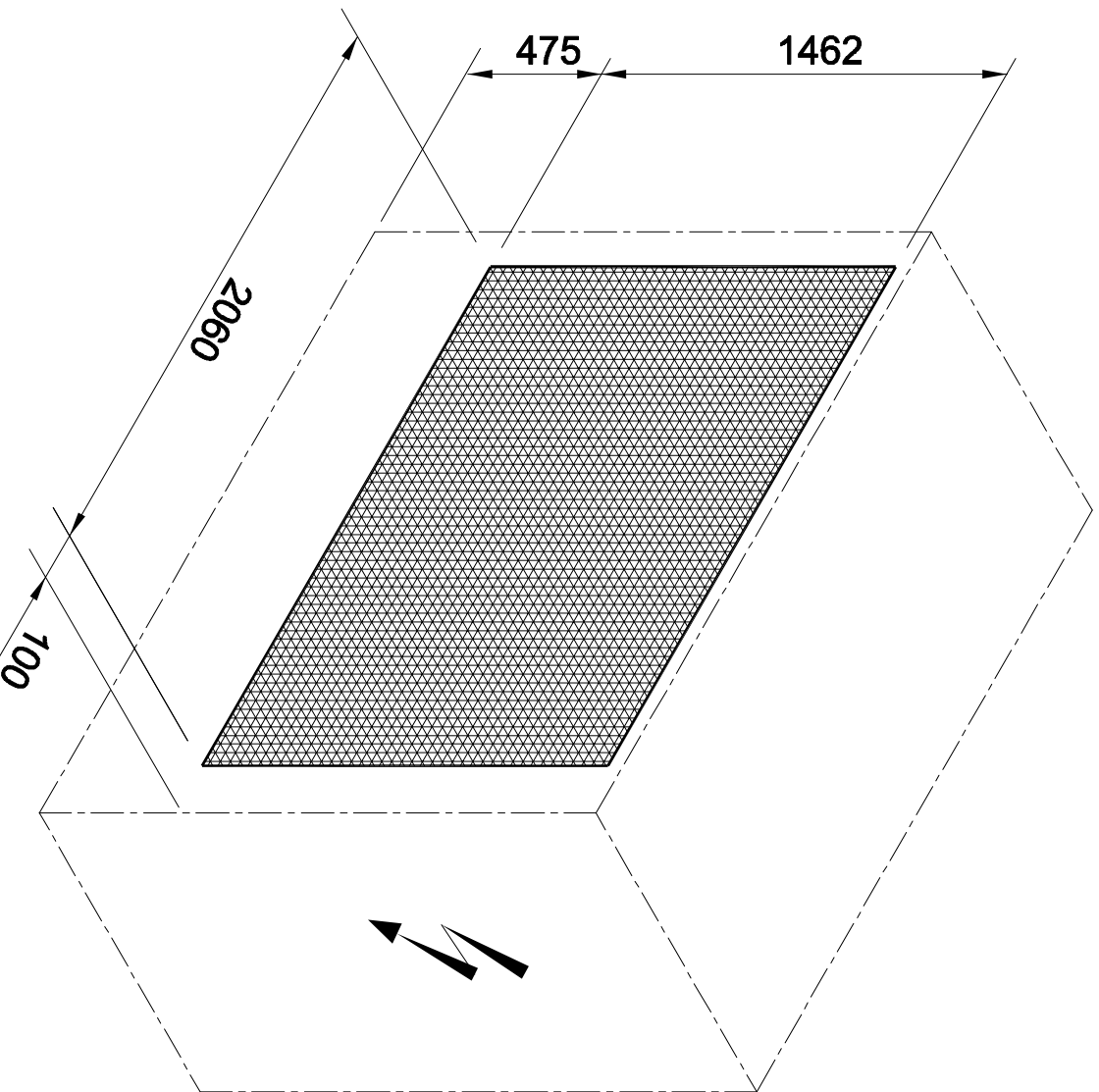

**FILTRE & RACCORDEMENT VENTILATION**

Indice	Date	Nom

Modifications

Indice	Date	Norm
--------	------	------



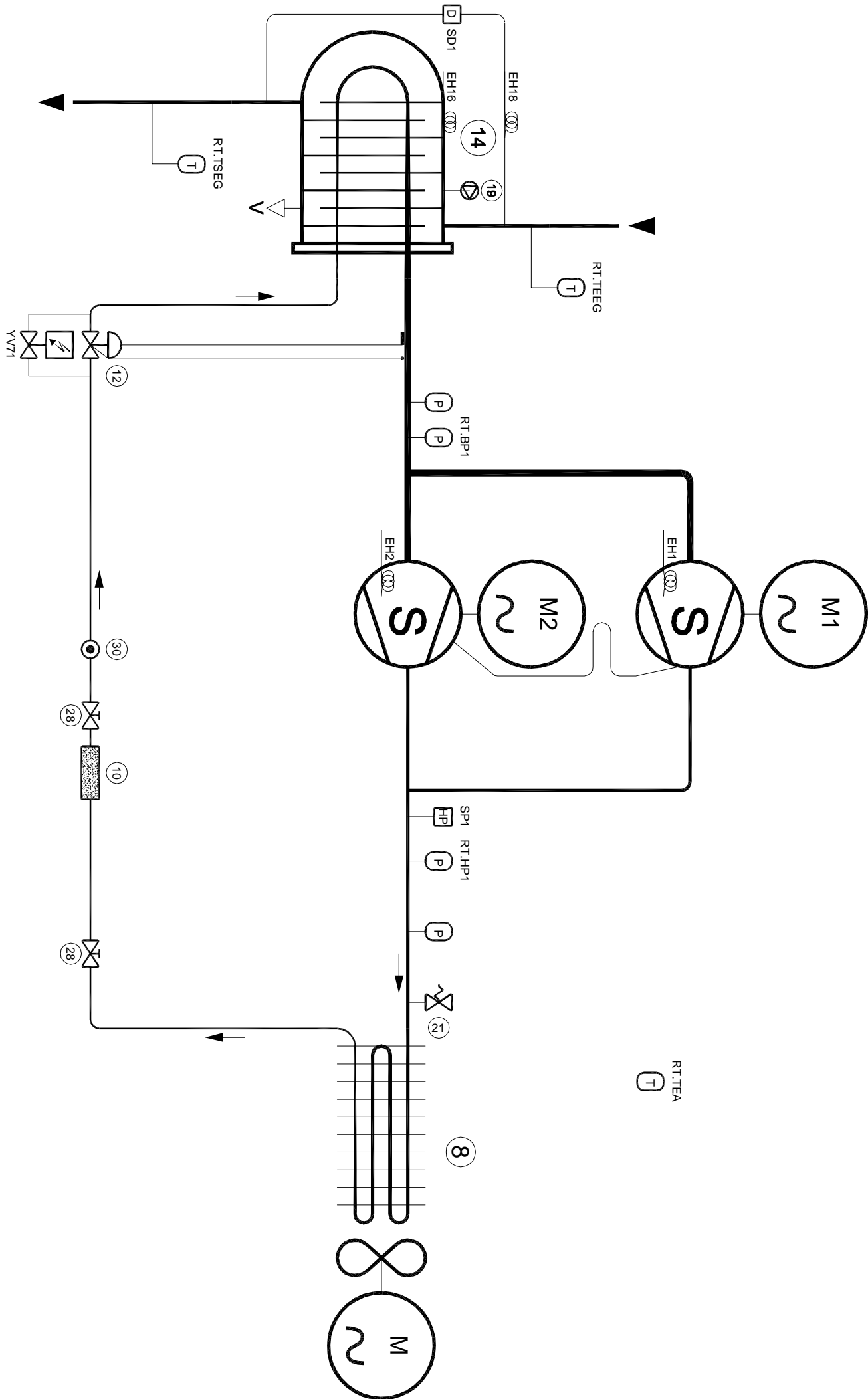



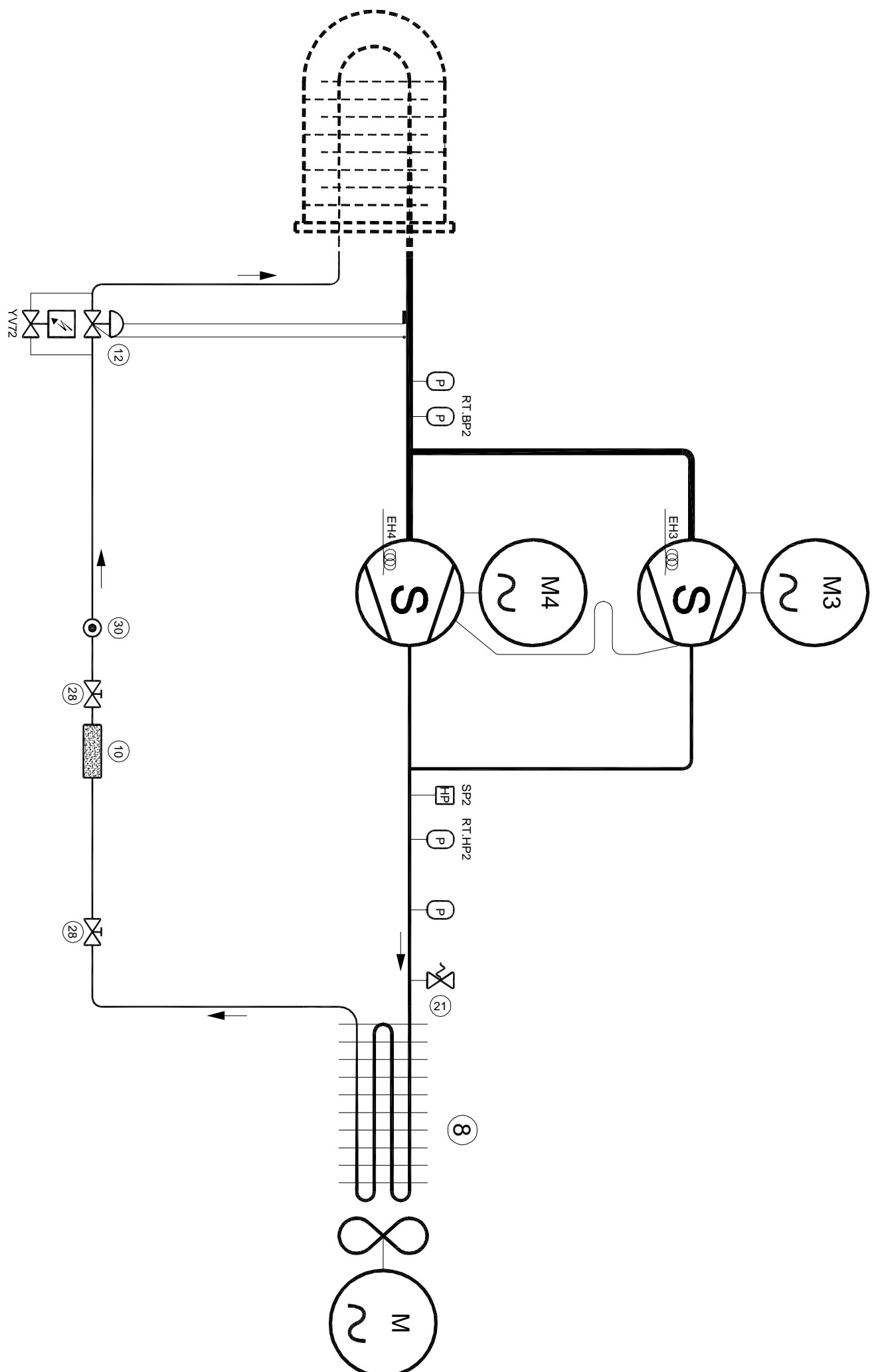











Modifications



SCHEMA FRIGORIFIQUE



SCHEMA FRIGORIFIQUE (circuit 2)

1	Antivibratile Vibration isolators	16	Economiseur Economiser	31	Vase d'expansion Expansion tank		Compresseur a piston Reciprocating compressor		Pressostat combin, BP + HP Combine HP-LP switch
2	Bac a eau Water pan	17	Diaphragme Diaphragm	32	Vanne de reglage Regulating valve		Compresseur scroll Scroll compressor		Vanne command, par pression Pressure operated valve
3	Boutelle anti-coup de liquide Anti-slugging receiver	18	Echangeurs divers Miscellaneous exchangers	33	Vanne de vidange Drain valve		Compresseur a vis Screw compressor		Vanne a commande, lectrique Electrically operated valve
4	Boutelle reservoir Receiver	19	Purgeur d'air Air purges	34	Disconnecteur Disconnecter		Pompe Pump		Resistance Heater
5	Vanne de remplissage Filling valve	20	Silencieux de refoulement Discharge silencer	35	Boutelle compensatrice Compensating tank		Moteur Motor		
6	Clapet de decharge eau Water discharge valve	21	Soupape de securite Safety valve	36	Vanne de tarionnage manometre Pressure gauge setting valve		Controlleur de d'bit Flow switch		
7	Clapet de retenue Retaining valve	22	Separateur d'huile Oil separator	37	D'iente par capillaire Capillary expansion system		Controlleur de niveau Level controller		
8	Condenseur a air Air cooled condenser	23	Vanne 3 voies 3-way valve				Controlleur de pression Pressure controller		
9	Condenseur a eau Water cooled condenser	24	Vanne 4 voies 4-way valve				Controlleur de temp,rature Temperature controller		
10	Deshydrateur Drier	25	Vanne aspiration compresseur Compressor suction valve				Indicateur de niveau Level indicator		
11	Dentendeur electronique Electronic expansion valve	26	Vanne refoulement compresseur Compressor discharge valve				Indicateur de pression Pressure indicator		
12	Detendeur thermostatique Thermostatic expansion valve	27	Vanne pressostatique Pressure operated valve				Indicateur de temperature Temperature indicator		
13	Filtre Filter	28	Vanne a main Manual valve				Pressostat basse pression Low pressure switch		
14	Evaporateur a eau Water evaporator	29	Evaporateur a air Air cooled evaporator				Pressostat haute pression High pressure switch		
15	Vidange Drain	30	Voyant liquide Liquid sightglass				Pressostat d'huile Oil pressure switch		

## SCHEMA FRIGORIFIQUE &amp; HYDRAULIQUE

# Plot antivibratile / Vibration isolators / Schwingungsdämpfer / Antivibracion / Veerdempers / Antivibratorio / Vibrationdampere

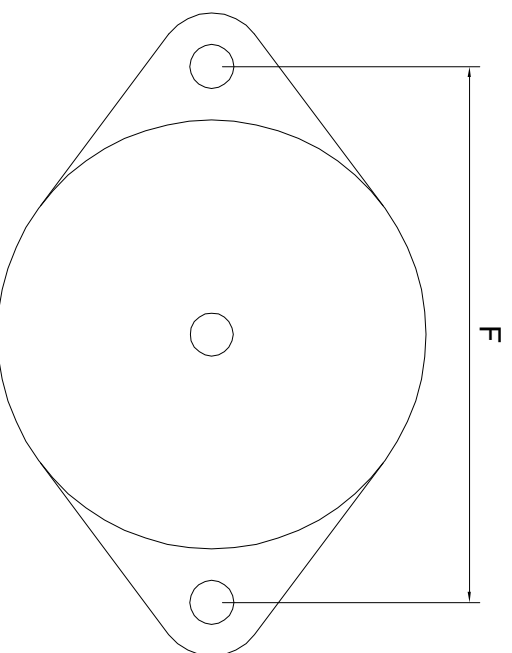
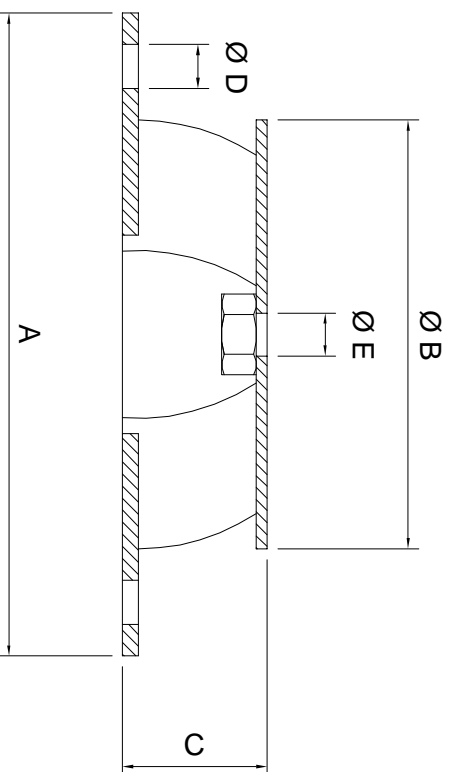

	A	B	C	D	E	F
80 (/45/60/75)	120	80	27	8.2	M8	100
100 (/45/60/75)	148	100	28	10.2	M10	124
150 (/45/60/75)	214	150	39	12.2	M14	182
200 (/45/60/75)	280	200	44	14.5	M18	240



# MANUTENTION - HANDLING

**POIDS**      **1392 kg**  
**WEIGHT**

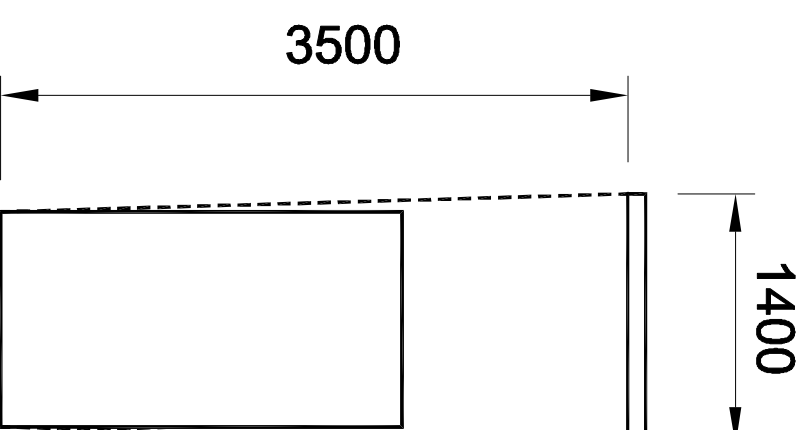
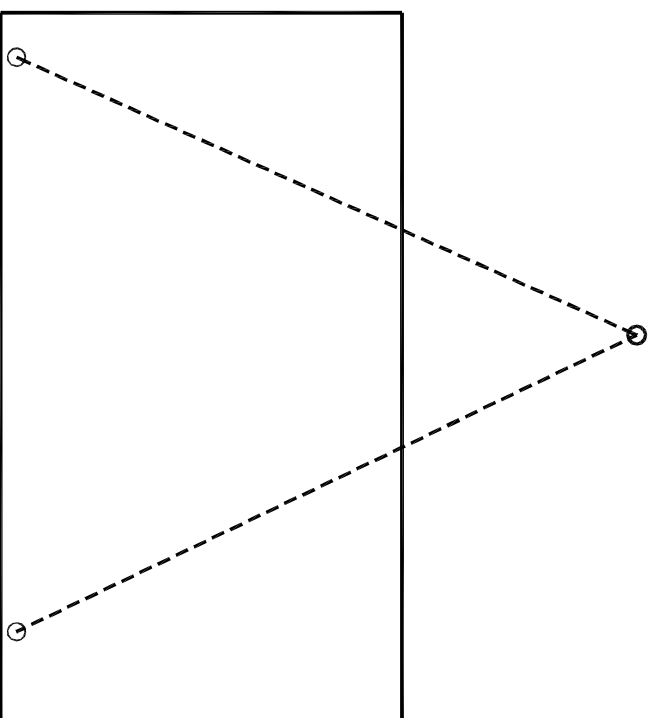
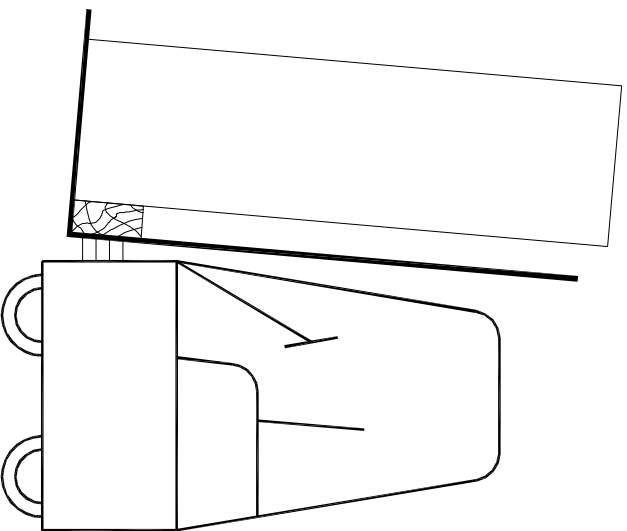

4500642218

DM132982