

*DOSSIER ELECTRIQUE  
ELECTRICAL FILE*

Index / Index	Date	Num / Name	Modifications



LCH 652 VK LNE		Num: / Name:
LENDX UK		B-S
		Date:
		13-11-2007
SE138189		
		0 / 13



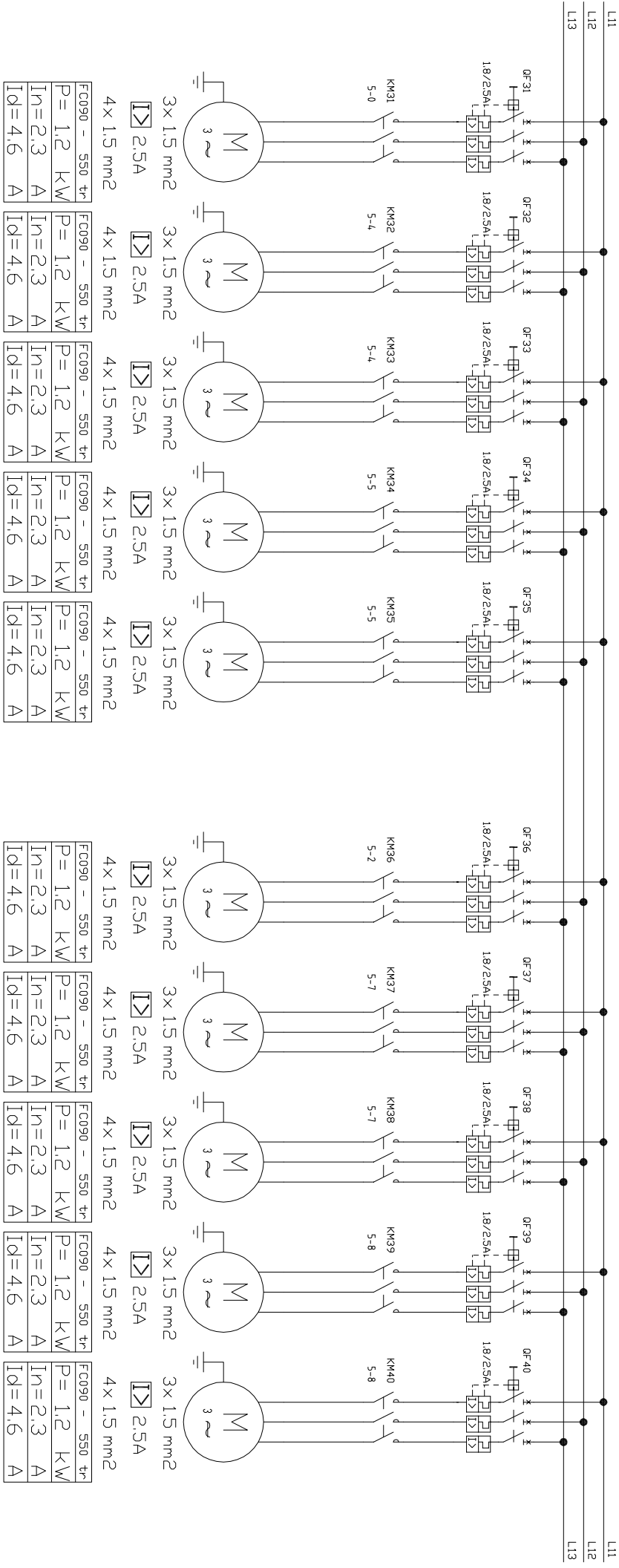

OF31									
NO	NF								
	9-1								

OF32									
NO	NF								
	9-1								

OF33									
NO	NF								
	9-1								

OF34									
NO	NF								
	9-2								

OF35									
NO	NF								
	9-2								

OF36									
NO	NF								
	9-1								

OF37									
NO	NF								
	9-1								

OF38									
NO	NF								
	9-1								

OF39									
NO	NF								
	9-2								

OF40									
NO	NF								
	9-2								

# SCHEMA ELECTRIQUE

0 1 2 3 4 5 6 7 8 9

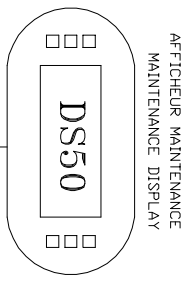

AFICHEUR MAINTENANCE  
MAINTENANCE DISPLAY

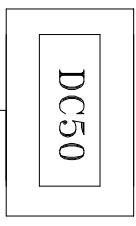

AFICHEUR LOCAL  
LOCAL DISPLAY

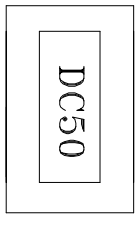

AFICHEUR DISTANT  
REMOTE DISPLAY

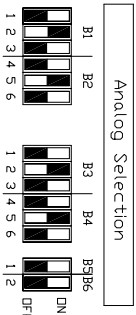

Analog Selection

Input B1-B2-B3-B4		Input
OFF	OFF	0/1V
DN	OFF	NTC
OFF	DN	0/20mA
OFF	OFF	0/5V

Input B5-B6		Input
DN	digital input	
OFF	NTC	

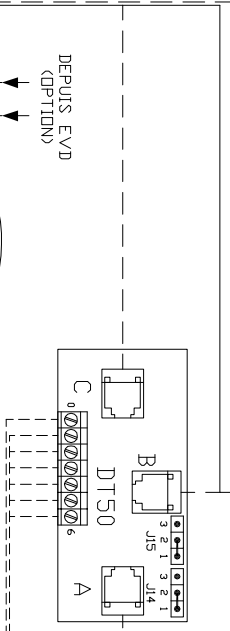

DEPUIS EVD  
(OPTION)

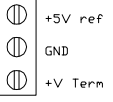

J11



J12



J13



J14



J15



J16



J17



J18

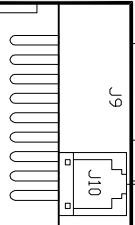

Clock Cord

BM50 Master

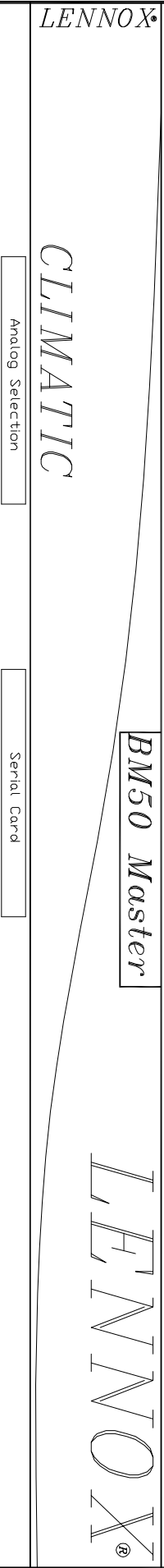

Analog Selection

Serial Card

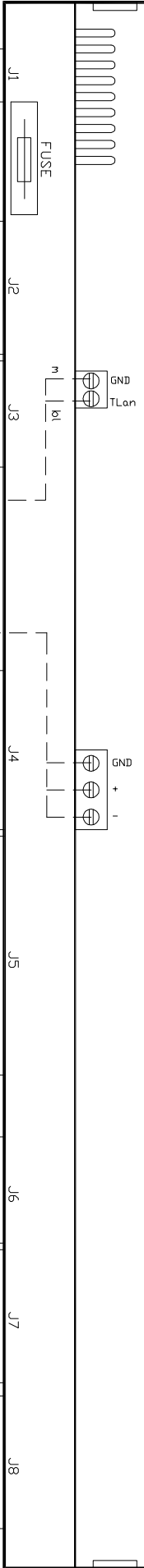

Index

DATE

NOM

MODIFICATIONS

SCHEMA ELECTRIQUE

CLIMATIC 50

BM50 Master  
S.LOG

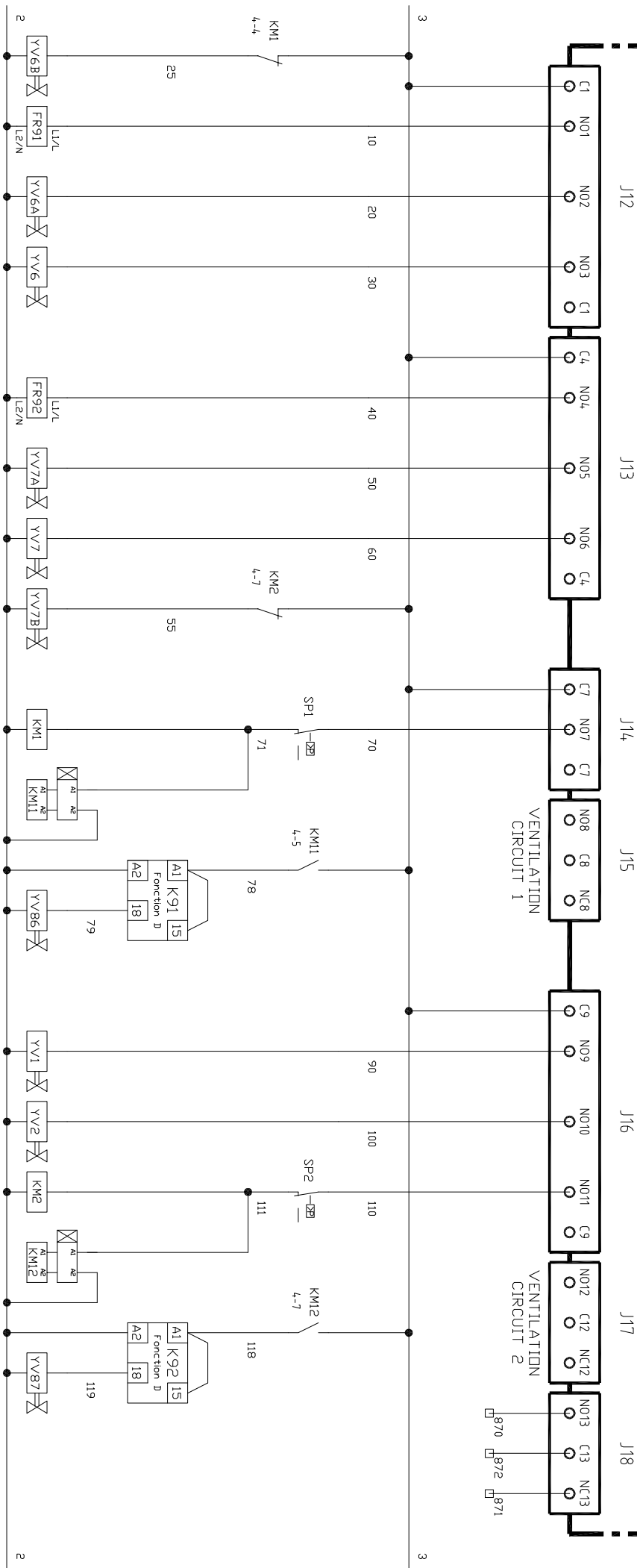

FR91	NO	NF
6-0	6-0	

FR92	NO	NF
6-2	6-2	

KM1	NO	NF
9-0	9-9	

KM1	NO	NF
1-2	1-2	

REGLAGES  
100%  
10s  
D

KM2	NO	NF
9-1	9-9	

KM2	NO	NF
1-5	1-5	

REGLAGES  
100%  
10s  
D

# SCHEMA ELECTRIQUE

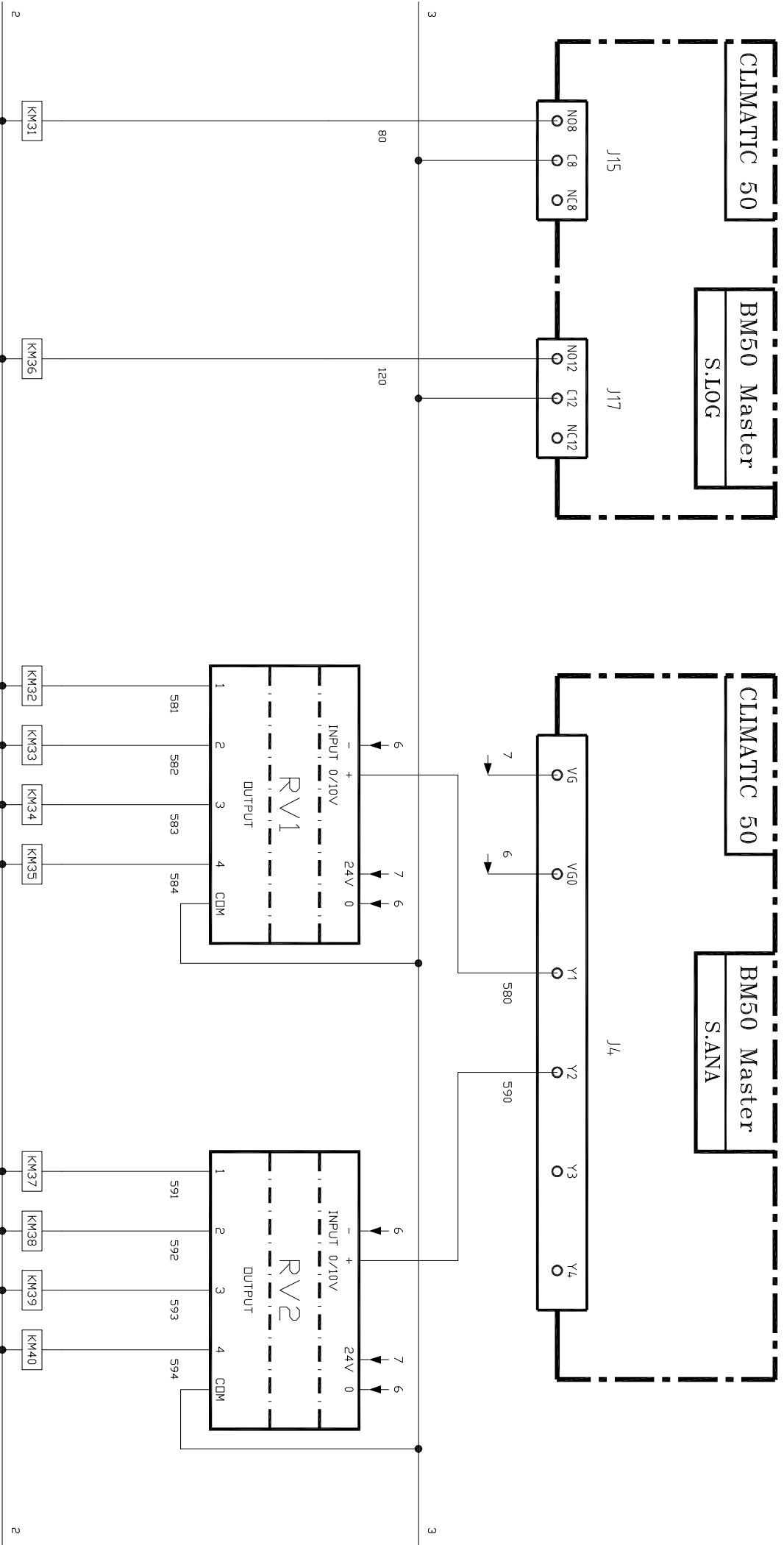

KN31	NO	NF
2-1		
2-1		
2-1		

KN36	NO	NF
2-5		
2-5		
2-5		

KN32	NO	NF
2-1		
2-1		
2-1		

KN33	NO	NF
2-2		
2-2		
2-2		

KN34	NO	NF
2-3		
2-3		
2-3		

KN35	NO	NF
2-4		
2-4		
2-4		

KN37	NO	NF
2-6		
2-6		
2-6		

KN38	NO	NF
2-7		
2-7		
2-7		

KN39	NO	NF
2-8		
2-8		
2-8		

KN40	NO	NF
2-9		
2-9		
2-9		

# SCHEMA ELECTRIQUE

CLIMATIC 50

BM50 Master  
E.LOG

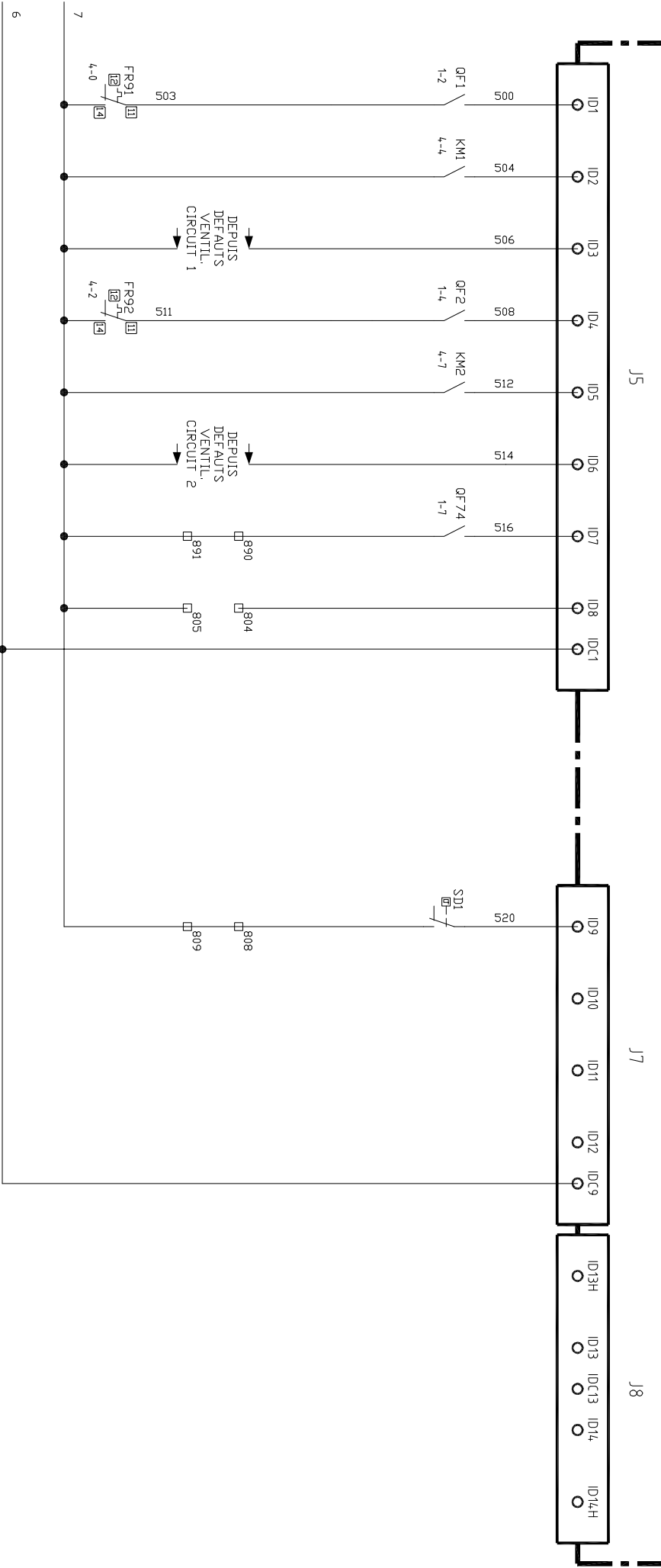

Index	DATE	NOM	MODIFICATIONS

# SCHEMA ELECTRIQUE

CLIMATIC 50

BM50 Master  
E.ANA

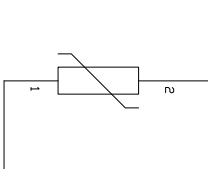
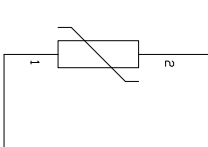
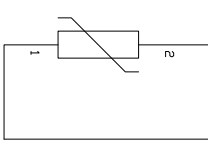
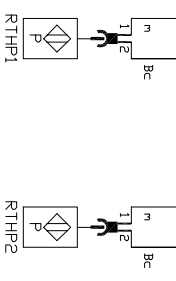
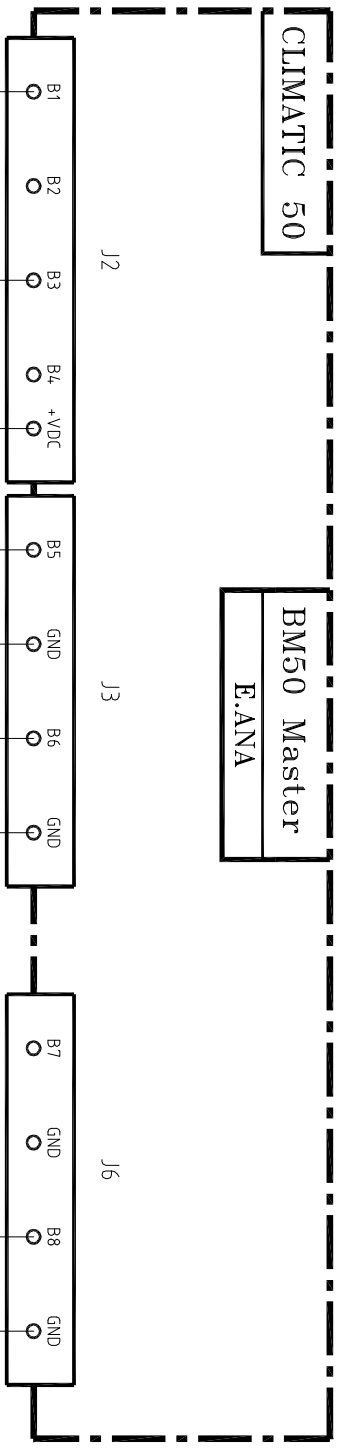

Index	
DATE	
NOM	
MODIFICATIONS	

# SCHEMA ELECTRIQUE



VERS CLIMATIC 50 (J11)  
LE PLUS COURT POSSIBLE

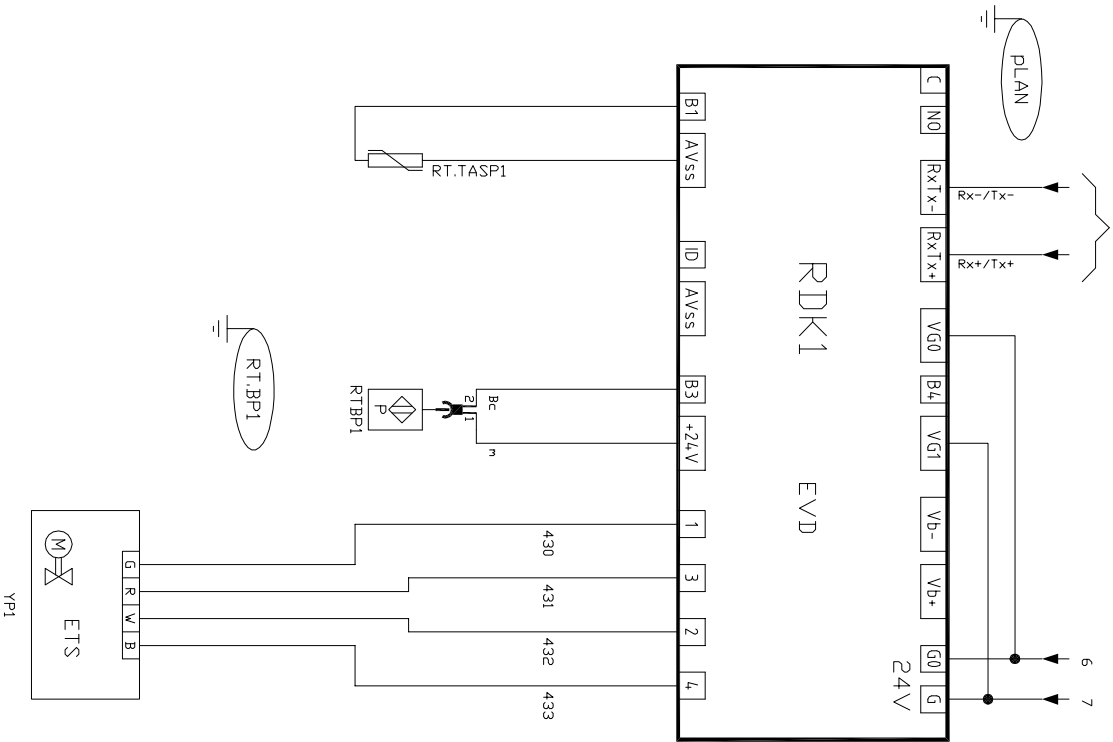

VERS CLIMATIC 50 (J11)  
LE PLUS COURT POSSIBLE

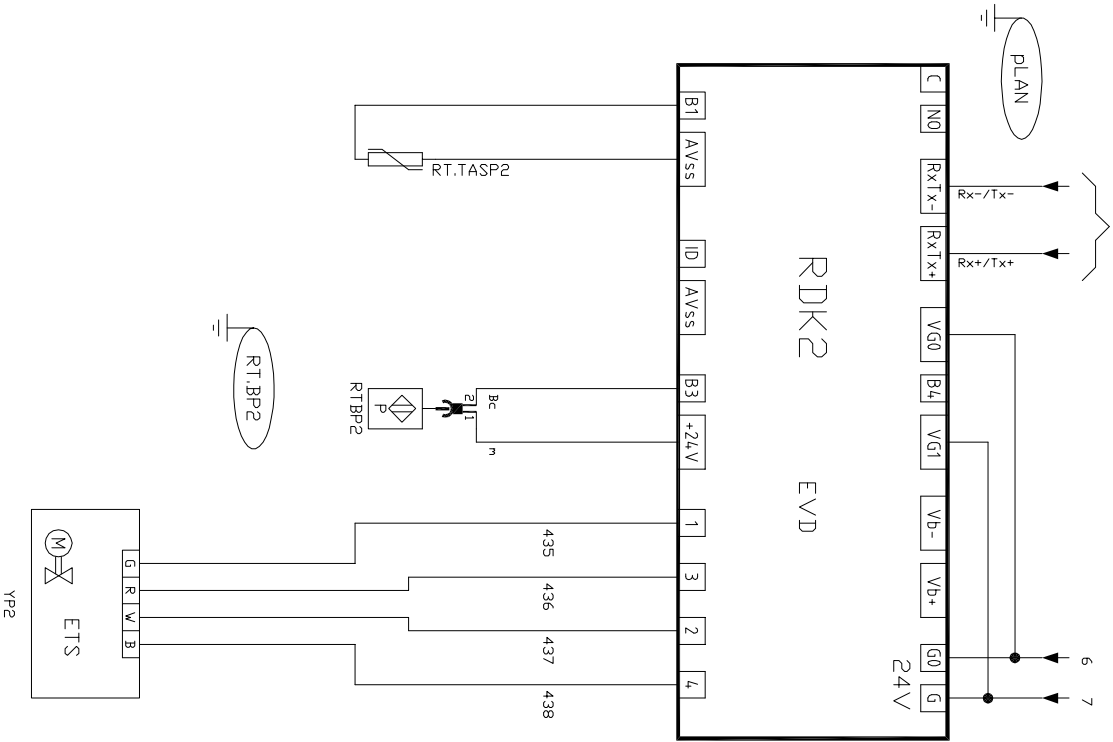

INDEX

DATE

NOM

MODIFICATIONS

# SCHEMA ELECTRIQUE

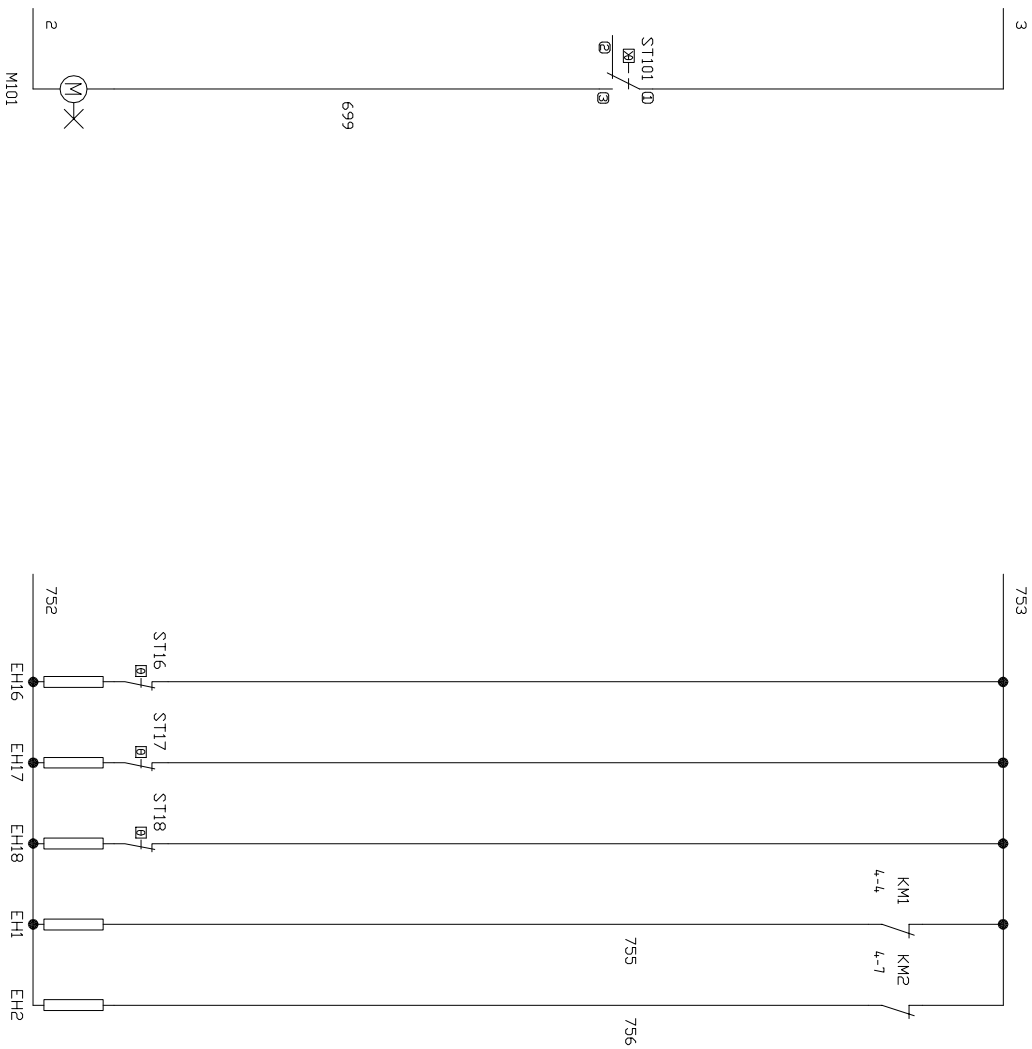
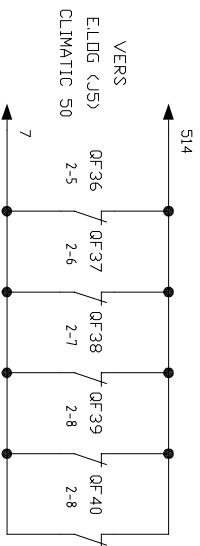
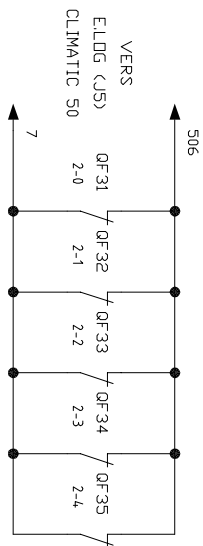
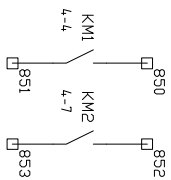

Index	DATE	NOM	MODIFICATIONS

# SCHEMA ELECTRIQUE

Index	
DATE	
NOM	
MODIFICATIONS	

0 1 2 3 4 5 6 7 8 9

ALIMENTATION  
GENERALE  
GENERAL  
SUPPLY

NEUTRAL	(OPTION) NEUTRE	N
PHASE 1	PHASE 1	L1
PHASE 2	PHASE 2	L2
PHASE 3	PHASE 3	L3
EARTH	TERRE	PE

FAULTS RESET NC=RESET	RESET DES DEFAUTS NF=RESET	804 805
CUSTOMER 'S WATER FLOW OF EVAPORATOR	DEBIT EVAPORATEUR CLIENT (CONTACT SEC)	808 809
REMOTE CONTACT FOR COMPRESSOR 1	REPORT CONTACT SEC DE MARCHE COMPRESSEUR 1	850 851
REMOTE CONTACT FOR COMPRESSOR 2	REPORT CONTACT SEC DE MARCHE COMPRESSEUR 2	852 853
REMOTE CONTACT NORMALLY OPEN REMOTE CONTACT NORMALLY CLOSED GENERAL FAILURE UNIT	REPORT CONTACT SEC N.O REPORT CONTACT SEC N.F DE DEFAUT GENERAL GROUPE	870 871 872
REMOTE ON/OFF FOR THE UNIT	MARCHE/ARRET A DISTANCE GROUPE (CONTACT SEC)	890 891

SCHEMA ELECTRIQUE

0	1	2	3	4	5	6	7	8	9
A1->9	Horloge de degivrage Defrost timer		FU90 . . . .	Fusible divers Various fuse		KA01	Relais auxiliaire d'alarme (sauf SULZER) Alarm auxiliary relay (exept Sulzer)		
AP4	Carte de permutatiön Sequense switch card		FV . . . .	Relais seuil tensiön Voltage level relay		KA02	Relais auxiliaire M/A à distance (24 V ou autre) Remote Start/Stop auxiliary relay (24V or else)		
C . . . .	Condensateur Capacitor		HA . . . .	Signalisation sonore Sound signal		KA1->9	Relais chaîne de securite compresseur ou circuit Compressor or circuit safety line relay		
D1 . . . .	Relais anti-court cycle Anti-short cycle relay		HL01	Voyant defaut general General fault lamp		KA10->12	Relais Marche / Arrêt ON / OFF relay		
EHT->10	Resistance Carter Crankcase heater		HL1->9	Voyant marche compresseur Compressor operating lamp		KA15	Relais pump down au demarrage Pump down relay		
EHT1->15	Resistance bouteille Receiver heater		HL11->20	Voyant marche ventilateur Fan operating lamp		KA31->34	Relais marche forcee vanne liquide Solenoid liquid valve forced operation relay		
EHT6->25	Resistance evapörateur Evaporator heater		HL25->29	Voyant defaut pompe Pump fault lamp		KA40	Presence tensiön On line relay		
EH26->35	Resistance condenseur Condenser heater		HL30	Voyant sous tensiön Power On lamp		KA41->49	Relais renvoi defaut compresseur Remote compressor fault relay		
EH65->70	Resistance pompe Pump heater		HL31->39	Voyant arrêt contrôle Control thermostat stop lamp		KA50->75	Relais divers Various relay		
EH90->100	Resistance diverse Various heater		HL41->49	Voyant arrêt securite Safety stop lamp		KA76	Relais thermostat antigel Antifreeze thermostat relay		
EH101 . . . .	Resistance armoire Electrical panel heater		HL51->60	Voyant defaut ventilateur Fan fault lamp		KA80	Relais contrôleur de debit Flow switch relay		
EL . . . .	Eclairage Lighting		HL65->69	Voyant marche pompe Pump operation lamp		KA91->99	Relais protection interne compresseur Solid-state motor protection relay		
FA . . . .	Relais seuil de courant Current limit relay		HL90 . . . .	Voyant divers Various lamps		KM1->24	Contacteur compresseur Compressor contactor		
FR1->19	Relais thermique compresseur Compressor motor thermal overload contactor		K1->9	Inter temporise demarrage compresseur Compressor start timer		KM31->64	Contacteur ventilateur Fan contactor		
FR31->64	Relais thermique ventilateur Fan motor thermal overload contactor		K15->22	Inter temporise pump down au demarrage Pump down timer		KM65->85	Contacteur pompe Pump contactor		
FR65->70	Relais thermique pompe Pump motor thermal overload contactor		K31->34	Inter temporise passage ventilation GV / PV Fan HS / LS permutatiön timer		KM90 . . . .	Contacteur divers Various contactor		
FR80->90	Relais thermique divers Various motor protector		K41->49	Inter temporise renvoi defaut compresseur Remote compressor fault timer		KT1->9	Relais temporise demarrage compresseur Compressor start time delayed relay		
FR91->99	Protection moteur compresseur Solid-state motor protector		K61->65	Inter temporise by-pass pressostat B.P. L.P. pressostat by-pass timer		KT11->14	Relais temporise declage demarrages compresseurs Time delayed relay for compressor start gap		
FU1->50	Fusible moteur Motor fuse		K71->75	Inter temporise vanne by pass detendeur Expansion valve by-pass timer		KT15	Relais temporise arrêt groupe "type laiterie" Unit stop time delayed relay (dairy industry)		
FU60->69	Fusible contrôle Control fuse		K80	Inter temporise defaut debit Flow switch timer		KT21->24	Relais temporise coupure BP LP cut off time delayed relay		
FU70->78	Fusible protection transformateur Transformer protection fuse		K90 . . . .	Inter temporise divers Various timers		KT37	Relais cliqñoteur Cliqñoteur relay		

	0	1	2	3	4	5	6	7	8	9
	KT41->49	Relais temporise renvoi defaut Remote fault time delayed relay		QF70->89	Disjoncteur protection circuit commande Control circuit protection circuit breaker		SA11	Interrupteur local/distance Local/remote switch		
	KT90 . . . .	Relais temporise divers Various time delayed relay		QF90 . . . .	Disjoncteur divers Various circuit breaker		SA12->16	Interrupteur marche pompe Pump on/off switch		
	M1->9	Compresseur Compressor motor		QS1->30	Porte fusible compresseur Compressor fuse breaker		SA17	Permutateur compresseur Compressor permutation switch		
	M11->M15	Anti-court cycle Anti-short cycle		QS31->64	Porte fusible ventilateur Fan fuse breaker		SA18-19	Permutateur pompe Pump permutation switch		
	M31->64	Ventilateur Fan motor		QS65->69	Porte fusible pompe Pump fuse breaker		SA20	Permutateur ete/hiver Summer/winter switch		
	M65->70	Pompe Pump		QS90 . . . .	Porte fusible divers Various fuse breaker		SA21	Permutateur M/A klaxon Horn switch ON/OFF		
	M90->100	Moteur divers Various motors		QSG	Interrupteur general Main power interrupter		SA90 . . . .	Interrupteur divers Various switches		
	M101-102	Ventilateur d'armoire Electrical panel fan			ouSectionneur general orMain power switch		SB1	Bouton poussoir hors tension Off line push button		
	M111->109	Ventilateur de culasse compresseur Compressor cylinder head fan			ouDisjoncteur general orMain power circuit breaker		SB2	Bouton poussoir sous tension On line push button		
	UCHILLER	Regulateur Regulator		R . . . .	Resistance triphassee 3 phase heater		SB3->6	Bouton poussoir marche Start push button		
	AP2	Module supplementaire (CP2) Extra regulator module (CP2)		RC . . . .	Circuit RC RC circuit		SB7->9	Bouton poussoir arrêt Stop push button		
	AP31-32 (RV1-2)	Relais de commande ventilateur monophasse Command relay for single phase fan motor		RT . . . .	Sonde ou capteur Temperature or pressure sensor		SB10	Bouton poussoir arrêt d'urgence Emergency stop push button		
	AP1	Module de base (CP1) Basic module (CP1)		RTTEA	Temperature d'entree d'air Air inlet temperature		SB11	Bouton poussoir arrêt klaxon Horn stop push button		
	P1 . . . .	Afficheur D27 ouPC905 D27 or PC905 display		RTTEEG	Temperature d'entree d'eau glacee Cold water inlet temperature		SB12	Bouton poussoir test lampe Lamp test push button		
	PA . . . .	Ampèremètre Ammeter		RTSEG	Temperature de sortie d'eau glacee Cold water outlet temperature		SB16->24	Bouton poussoir rearmentent huile Oil pressotat reset push button		
	PJ . . . .	Wattmètre (compteur d'energie) Wattmeter		RTREF . . . .	Temperature de refoulement Discharge temperature		SB25->29	Bouton poussoir arrêt pompe Pump stop push button		
	PT1->9	Compteur horaire Hour meter		RTTASP . . . .	Temperature d'aspiration Suction temperature		SB41	Bouton poussoir effacement defaut Fault reset push button		
	PV . . . .	Voltmètre		RTTBP . . . .	Temperature d'evaporation Evaporating temperature		SB65->69	Bouton poussoir marche pompe Start pump push button		
	QF1->14	Disjoncteur compresseur Compressor circuit breaker		RV1 . . . .	Variateur de vitesse Speed regulator		SB76->80	Bouton poussoir rearmentent antigel Antifreeze reset push button		
	QF31->64	Disjoncteur ventilateur Fan circuit breaker		SA1->5	Interrupteur sous tension On-off switch		SB90 . . . .	Bouton poussoir divers Various push button		
	QF65->69	Disjoncteur pompe Pump circuit breaker		SA6->10	Interrupteur marche circuit Circuit start switch		SD1 . . . .	Contrôleur de débit Flow switch		

## SCHEMA ELECTRIQUE

	0	1	2	3	4	5	6	7	8	9
SL1->5	Contrôleur de niveau d'eau Water level controller			ST36->40	Thermostat depart d'eau Water outlet thermostat			YV36->40	Electrovanne gaz chauds pressostatique Pressostatic hot gas solenoid valve	
SL16->20	Contrôleur de niveau d'huile Oil level controller			ST41->45	Thermostat retour d'eau Water inlet thermostat			YV41->45	Electrovanne gaz chauds thermostatique Thermostatic hot gas solenoid valve	
SP1->9	Pressostat HP HP pressostat			ST46->55	Thermostat d'huile Oil thermostat			YV46->50	Electrovanne decharge bouteille Receiver by-pass valve	
SP11->15	Pressostat BP LP pressostat			ST56->64	Thermostat de surchauffe Overheat thermostat			YV51->55	Electrovanne aspiration Suction solenoid valve	
SP16->25	Pressostat d'huile Oil pressostat			ST71->75	Thermostat de degivrage Defrosting thermostat			YV56->60	Electrovanne by pass condenseur (ete/hiver) Condenser by-pass solenoid valve (winter/summer)	
SP26->30	Pressostat BP antigel Antifreeze pressostat			ST76->85	Thermostat antigel Antifreeze thermostat			YV61->70	Electrovanne inversion cycle Reverse cycle solenoid valve	
SP31->50	Pressostat HP de commande ventilateur Fan control HP pressostat			ST90->100	Thermostat divers Various thermostat			YV71->75	Electrovanne by pass detendeur Expansion valve by-pass solenoid valve	
SP51->55	Pressostat HP de commande resistance bouteille Receiver heater control pressostat			ST101 . . .	Thermostat resistance et ventilateur d'armoire Electrical panel fan and heater control thermostat			YV90 . . .	Electrovanne diverse Various solenoid valve	
SP56->60	Pressostat HP de commande vanne decharge bouteille Discharge valve control pressostat			T1 . . . . .	Transformateur CLIMATIC CLIMATIC transformer					
SP61->65	Pressostat HP de commande delestage Overload control pressostat			TA . . . . .	Transformateur d'intensite Current transformer					
SP66->70	Pressostat HP de commande degivrage Defrosting pressostat			TC1 . . . . .	Transformateur Transformer					
SP71->75	Pressostat de commande by-pass detendeur Expansion valve by-pass control pressostat			V . . . . .	Diode Diode					
SP90->110	Pressostat divers Various pressostat			VOPT . . . . .	Optocoupleur Optoelectronic coupler					
SP111->115	Pressostat HP/BP combine HP/LP pressostat			XB . . . . .	Barrette sectionnable Isolator link					
SQ1 . . . . .	Contact de porte Door contact			XSS90 . . . . .	Prise de courant Plug					
SR91 . . . . .	Contrôleur de phase Phase controller			YP1 . . . . .	Detendeur électronique Electronic expansion valve					
ST1->5	Thermostat de contrôle Control thermostat			YV1->5	Electrovanne liquide Liquid solenoid valve					
ST11->15	Thermostat de commande resistance bouteille Receiver heater control thermostat			YV6->15	Electrovanne reduction de puissance compresseur Compressor capacity control valve					
ST16->25	Thermostat de commande resistance evaporaieur Evaporator heater control thermostat			YV16->20	Electrovanne injection de liquide Liquid injection solenoid valve					
ST26->30	Thermostat de commande resistance condenseur Condenser heater control thermostat			YV21->25	Electrovanne economiseur Economizer solenoid valve					
ST31->35	Thermostat de commande ventilateur Fan control thermostat			YV26->35	Electrovanne by-pass compresseur Compressor by-pass solenoid valve					

INDEX

DATE

NOM

MODIFICATIONS

## SCHEMA ELECTRIQUE