

*DOSSIER ELECTRIQUE
ELECTRICAL FILE*

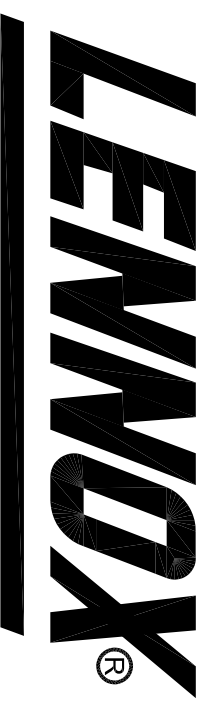

WA 230D K LN

Num: / Name
CTD /
Date: / Date
17/11/2004

SE128628

1/
19

CARACTERISTIQUES MACHINE			
MACHINE CHARACTERISTICS			
400 V	Pmax	Imax	Idem
	(kW)	(A)	(A)
3.50Hz	114.00	189.00	450.00

**CARACTERISTIQUES MOTEURS
MOTOR CHARACTERISTICS**

REPÈRE MARKER	DESIGNATION	DESIGNATION	REFERENCE REFERENCE	Pabs. (kW)	Inom. (A)
M1	Compresseur	Compressor motor	ZR19	17.72	28.66
M2	Compresseur	Compressor motor	ZR380	35.24	58.52
M3	Compresseur	Compressor motor	ZR19	17.72	28.66
M4	Compresseur	Compressor motor	ZR380	35.24	58.52
M31	Ventilateur	Fan motor	ZA_1090	1.7	2.9
M32	Ventilateur	Fan motor	ZA_1090	1.7	2.9
M33	Ventilateur	Fan motor	ZA_1090	1.7	2.9
M34	Ventilateur	Fan motor	ZA_1090	1.7	2.9

NOMENCLATURE ARMOIRE ELECTRIQUE
ELECTRIC PANEL ASSEMBLY BILL OF MATERIAL

REPERE MARKER	DESIGNATION	DESIGNATION	FOURNISSEUR SUPPLIER	REFERENCE REFERENCE
AP1	Carte interface circuit 1	Interface board circuit1	INF-11b/c	
AP2	Carte interface circuit 2	Interface board circuit 2	INF-12b/c	
Dép1	Alimentation peigne	Supply cable assembly	GV1G09	
Dép2	Peigne 1	Cable assembly 1	GV2G245	
KM1	Contacteur compresseur M1	Compressor contactor M1	GV2DM132B7	
KM2	Contacteur compresseur M2	Compressor contactor M2	LC1D50B7	
KM3	Contacteur compresseur M3	Compressor contactor M3	GV2DM132B7	
KM32	Contacteur ventilateur M32	Fan contactor M32	GV2ME08K1B7	
KM34	Contacteur ventilateur M34	Fan contactor M34	GV2ME08K1B7	
KM4	Contacteur compresseur M4	Compressor contactor M4	LC1D50B7	
QF2	Disjoncteur compresseur M2	Compressor circuit breaker M2	GV3ME63	
QF31	Disjoncteur ventilateur M31	Fan circuit breaker M31	GV2ME083	
QF33	Disjoncteur ventilateur M33	Fan circuit breaker M33	GV2ME083	
QF4	Disjoncteur compresseur M4	Compressor circuit breaker M4	GV3ME63	
QF70	Disjoncteur pfmaitre TC1	Primary circuit breaker TC1	GB2DB07	
QF72	Disjoncteur secondaire TC1	Secondary circuit breaker TC1	GB2CD14	
QF73	Disjoncteur secondaire TC1	Secondary circuit breaker TC1	GB2CD14	
QF74	Disjoncteur départ résistances	Fan circuit breaker M38	GV2ME063	
QSG	Interrupteur	Main power switch	31102	
QSG	Répartiteur	Terminal block	4033	
QSG	Cde frontale prolongée	Front operated Isolator	31050	
QSG	Cache bornes	Terminal block cover	29324	
QSG	Répartiteur	Terminal block	4155	
TC1	Transformateur contrôle	Transformer 24V	ABL6TS40B	

SCHEMA ELECTRIQUE

0	1	2	3	4	5	6	7	8	9
EH1-->9	Résistance carter Crankcase heater		R	Résistances triphasée 3 phase heater		SP111-->115	Pressostat HP BP combiné HP LP combined switch		
EH11-->15	Résistance bouteille Receiver heater		RC	Circuits RC RC circuit		ST11-->15	Thermostat de commande résistances bouteille		
EH16-->25	Résistance évaporateur Evaporator heater		RT	Sondes ou Capteurs Temperature or pressure sensor		ST16-->25	Thermostat de commande résistances évaporateur		
EH26-->35	Résistance condenseur Condenser heater		RTTEA	Température d'entrée d'air Air inlet temperature		ST26-->30	Thermostat de commande résistances condenseur		
EH90-->100	Résistances diverses Various heaters		RTTEEG	Température d'entrée d'eau glacée Water inlet temperature		ST56-->65	Thermostat de surchauffe Overheat thermostat		
EH101	Résistance armoire Electrical panel heater		RTTSEG	Température de sortie d'eau glacée Water outlet temperature		ST66-->70	Thermostat de commande ventilateur armoire		
FR91-->99	Protection moteur compresseur Solid state motor protection		RTTREF	Température de refroidement Discharge temperature		ST71-->75	Thermostat de dégivrage Defrost thermostat		
FU90	Fusibles divers Various fuses		RTTASP	Température d'aspiration Suction temperature		ST76-->85	Thermostat antigel Antifreeze thermostat		
HA	Signalisation sonore Sound signal		RTTBP	Température d'évaporation Evaporating temperature		ST90-->100	Thermostat divers Various thermostat		
HL01	Voyant défaut général General fault light		SA90.	Interrupteurs divers Various switches		V	Diode Diode		
HL1-->9	Voyant marche compresseur Compressor operating light		SB90.	Bouillons pousoirs divers Various push buttons		VOPT	Optocoupleur Optoelectronic coupler		
HL11-->20	Voyant marche ventilateur Fan running light signal		SD1	Contrôleur de débit Flow switch		XB	Barette sectionnable Isolator link		
HL25-->29	Voyant défaut pompe Pump fault light signal		SL1-->5	Contrôleur de niveau d'eau Water Level controller		XS90	Prise de courant plug		
HL30	Voyant sous tension Voltage ON light signal		SL16-->20	Contrôleur de niveau d'huile Oil level controller		YP1-->5	Détendeur électronique Electronic expansion valve		
HL31-->39	Voyant arrêt contrôle Control shutdown light signal		SP1-->9	Pressostat HP sécurité HP pressure switch		YV1-->5	Electrovanne liquide liquid line solenoid valve		
HL41-->49	Voyant arrêt sécurité Safety shutdown light signal		SP11-->15	Pressostat BP sécurité BP pressure switch		YV6-->15	Electrovanne réduction de puissance compresseur Compressor capacity reduction solenoid valve		
HL51-->60	Voyant défaut ventilateur Fan shutdown light signal		SP16-->25	Pressostat d'huile Oil pressure switch		YV16-->20	Electrovanne injection de liquide Liquid injection solenoid valve		
HL65-->69	Voyant marche pompe Pump operation light		SP26-->30	Pressostat BP antigel Antifreeze LP pressure switch		YV21-->25	Electrovanne économiseur Economizer solenoid valve		
HL90	Voyant divers Various light signal		SP31-->50	Pressostat HP de commande ventilateur Fan control HP pressure switch		YV26-->35	Electrovanne by-pass compresseur Compressor by-pass solenoid valve		
KA50-->75	Relais divers Various relays		SP51-->55	Pressostat HP de commande résistance bouteille Receiver heater HP pressure switch		YV36-->40	Electrovanne gaz chauds pressostatique pressure control hot gas solenoid valve		
KM90	Contacteurs divers Various contacts		SP56-->60	Pressostat HP de commande vanne décharge bouteille Discharge valve HP pressure switch		YV41-->45	Electrovanne gaz chauds thermostatique Thermostatic hot gas solenoid valve		
KT90	Relais temporisés divers Various time delayed relays		SP61-->65	Pressostat HP de commande de délestage Overload control HP pressure switch		YV61-->70	Electrovanne inversion de cycle 4 way reversing solenoid valve		
M111	Ventilateur de culasse compresseur Compressor cylinder head fan		SP71-->75	Pressostat de commande by-pass détenteur Expansion valve by-pass control pressure switch		YV71-->75	Electrovanne by-pass détenteur Thermostatic expansion valve by-pass solenoid valve		
P1	Afficheur Display		SP90-->110	Pressostats divers Various pressure switch		YV90	Electrovanne diverses Various solenoid valves		

SE128628

SCHEMA ELECTRIQUE

0	1	2	3	4	5	6	7	8	9
EH1-->9	Crankcase heater		R	3 phase heater		SP111-->115	HP LP combined switch		
EH11-->15	Receiver heater		RC	RC circuit		ST11-->15	Receiver control thermostat		
EH16-->25	Evaporator heater		RT	Temperature or pressure sensor		ST16-->25	Evaporator resistance control thermostat		
EH26-->35	Condenser heater		RTTEA	Air inlet temperature		ST26-->30	Condenser resistance control thermostat		
EH90-->100	Various heaters		RTTEEG	Water inlet temperature		ST56-->65	Overheat thermostat		
EH101	Electrical panel heater		RTTSEG	Water outlet temperature		ST66-->70	Electrical panel fan control thermostat		
FR91-->99	Solid state motor protection		RTTREF	Discharge temperature		ST71-->75	Defrost thermostat		
FU90	Various fuses		RTTASP	Suction temperature		ST76-->85	Antifreeze thermostat		
HA	Sound signal		RTTBP	Evaporating temperature		ST90-->100	Various thermostat		
HL01	General fault light		SA90.	Various switches		V	Diode		
HL1-->9	Compressor operating light		SB90.	Various push buttons		VOPT	Optoelectronic coupler		
HL11-->20	Fan running light signal		SD1	Flow switch		XB	Isolator link		
HL25-->29	Pump fault light signal		SL1-->5	Water Level controller		XS90	plug		
HL30	Voltage ON light signal		SL16-->20	Oil level controller		YP1-->5	Electronic expansion valve		
HL31-->39	Control shutdown light signal		SP1-->9	HP pressure switch		YV1-->5	liquid line solenoid valve		
HL41-->49	Safety shutdown light signal		SP11-->15	BP pressure switch		YV6-->15	Compressor capacity reduction solenoid valve		
HL51-->60	Fan shutdown light signal		SP16-->25	Oil pressure switch		YV16-->20	Liquid injection solenoid valve		
HL65-->69	Pump operation light		SP26-->30	Antifreeze LP pressure switch		YV21-->25	Economizer solenoid valve		
HL90	Various light signal		SP31-->50	Fan control HP pressure switch		YV26-->35	Compressor by-pass solenoid valve		
KA50-->75	Various relays		SP51-->55	Receiver heater HP pressure switch		YV36-->40	Pressure control hot gas solenoid valve		
KM90	Various contactors		SP56-->60	Discharge valve HP pressure switch		YV41-->45	Thermostatic hot gas solenoid valve		
KT90	Various time delayed relays		SP61-->65	Overload control HP pressure switch		YV61-->70	4 way reversing solenoid valve		
M111	Compressor cylinder head fan		SP71-->75	Expansion valve by-pass control pressure switch		YV71-->75	Thermostatic expansion valve by-pass solenoid valve		
P1	Display		SP90-->110	Various pressure switch		YV90	Various solenoid valves		

SE128628

SCHEMA ELECTRIQUE

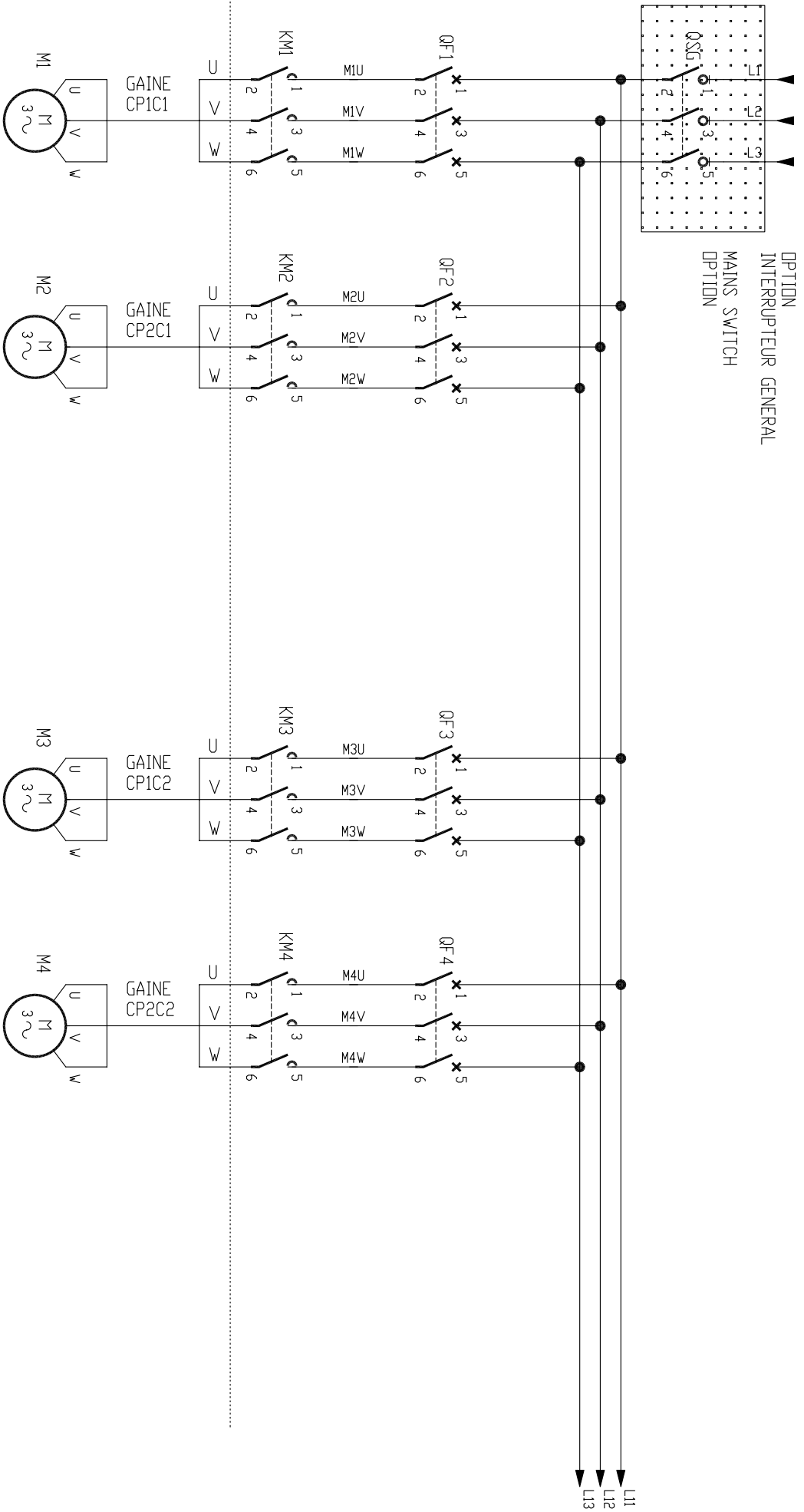

SCHEMA ELECTRIQUE

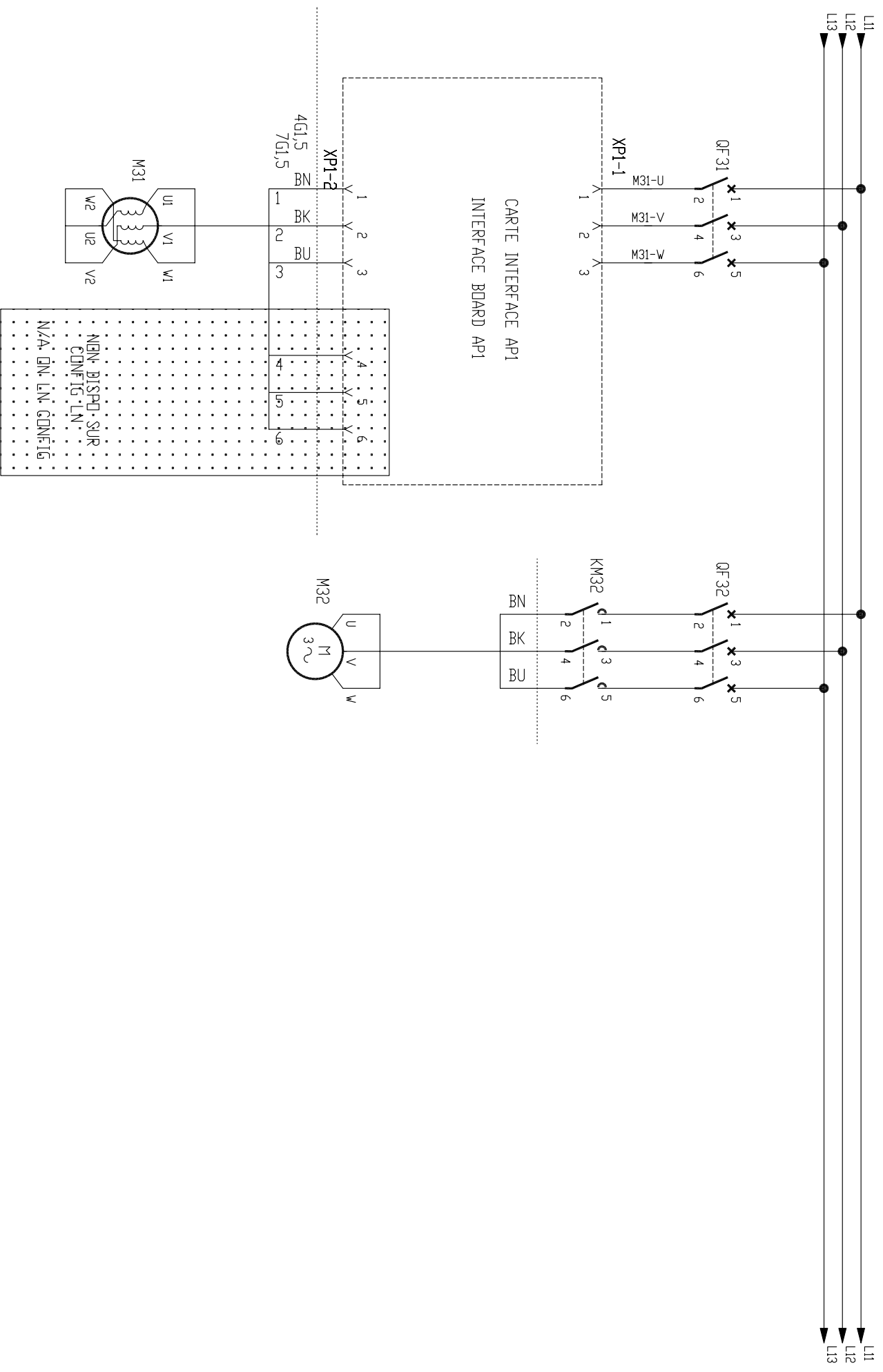

SCHEMA ELECTRIQUE

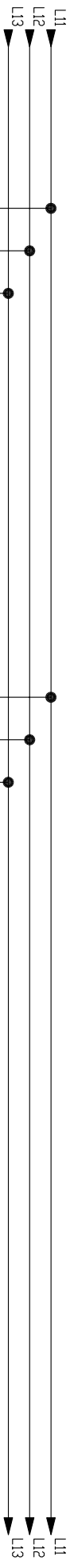

CARTE INTERFACE AP2
INTERFACE BOARD AP2

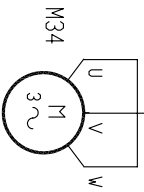
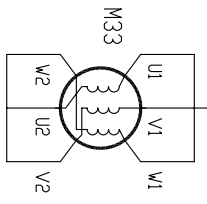
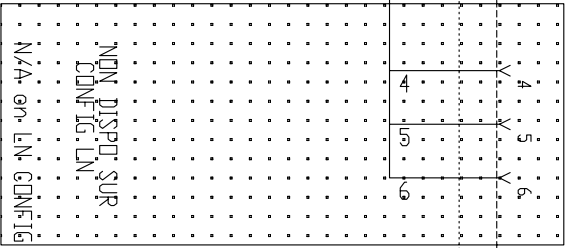
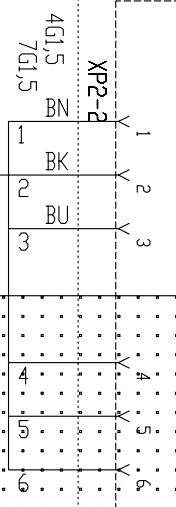
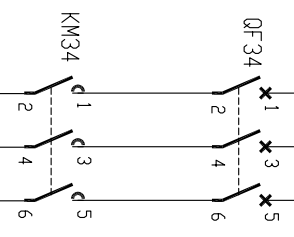
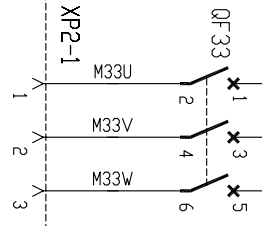

SCHEMA ELECTRIQUE

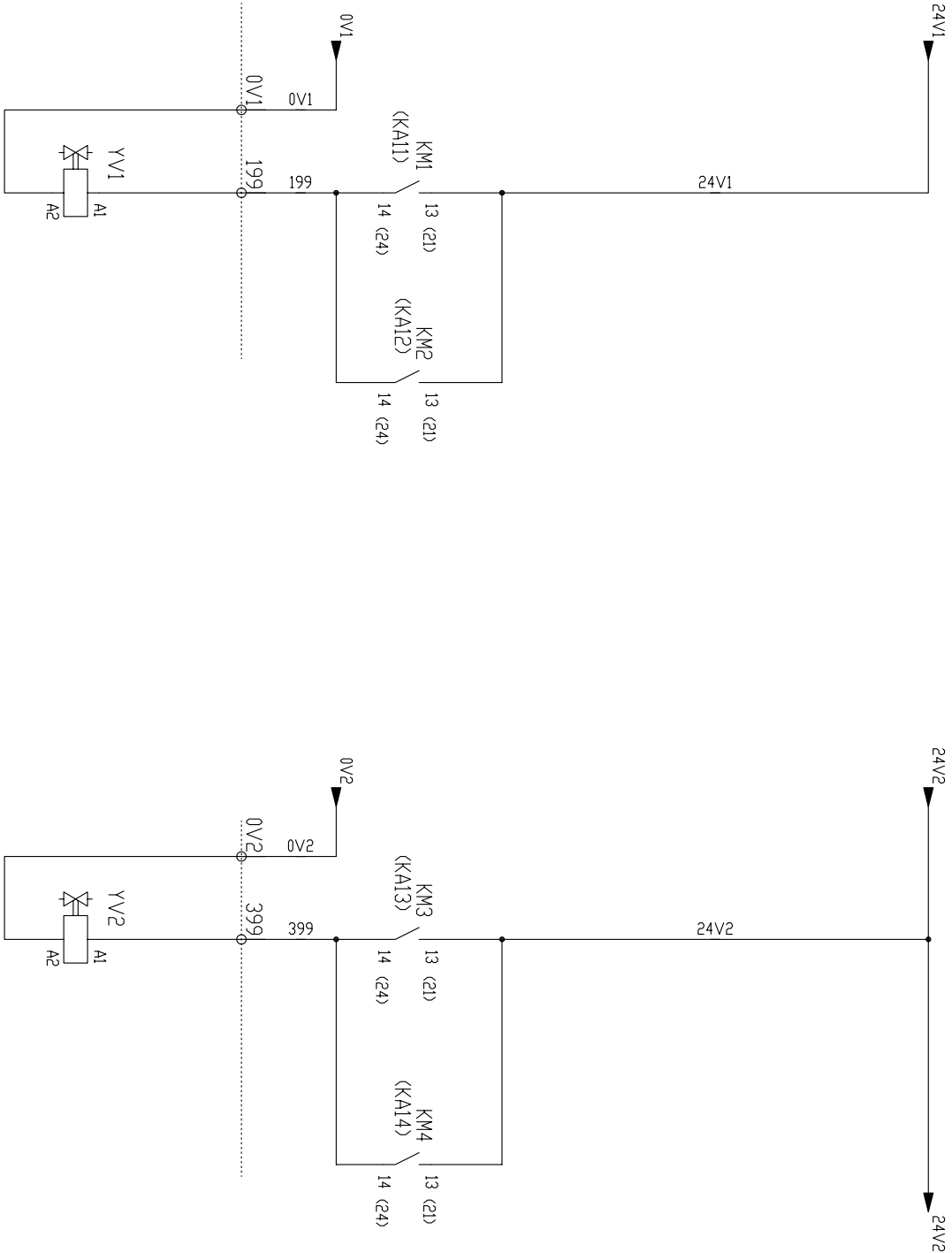

IF: SOFT STARTER OPTION LH4
 ST: DEM. ELEC. OPTION LH4
 KM1: --> KA11
 KM2: --> KA12
 KM3: --> KA13
 KM4: --> KA14

SCHEMA ELECTRIQUE

753

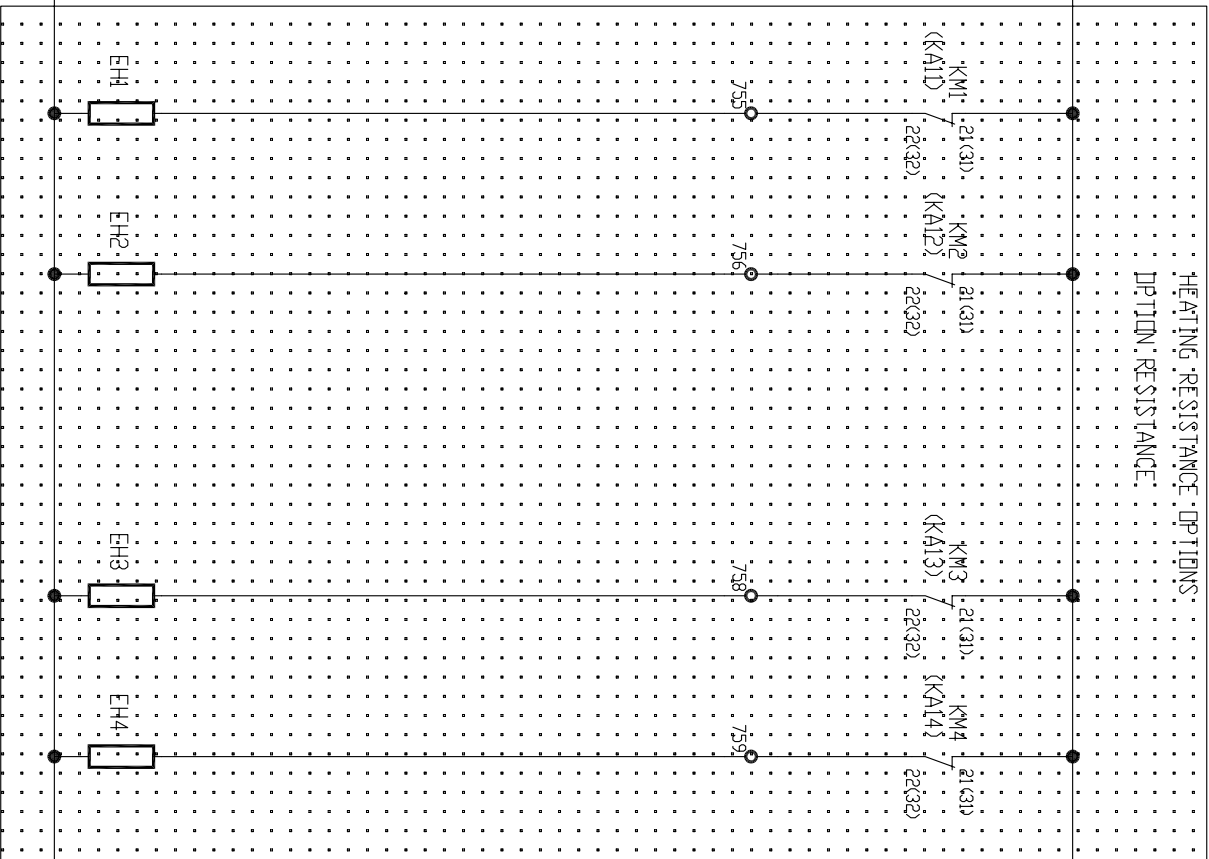

752

IF: SUE ISTARTER: OPTIEN LH4: KM1 --> KA11
 ST: DEM: ELEC: OPTIEN LH4: KM2 --> KA12
 KM3 --> KA13
 KM4 --> KA14

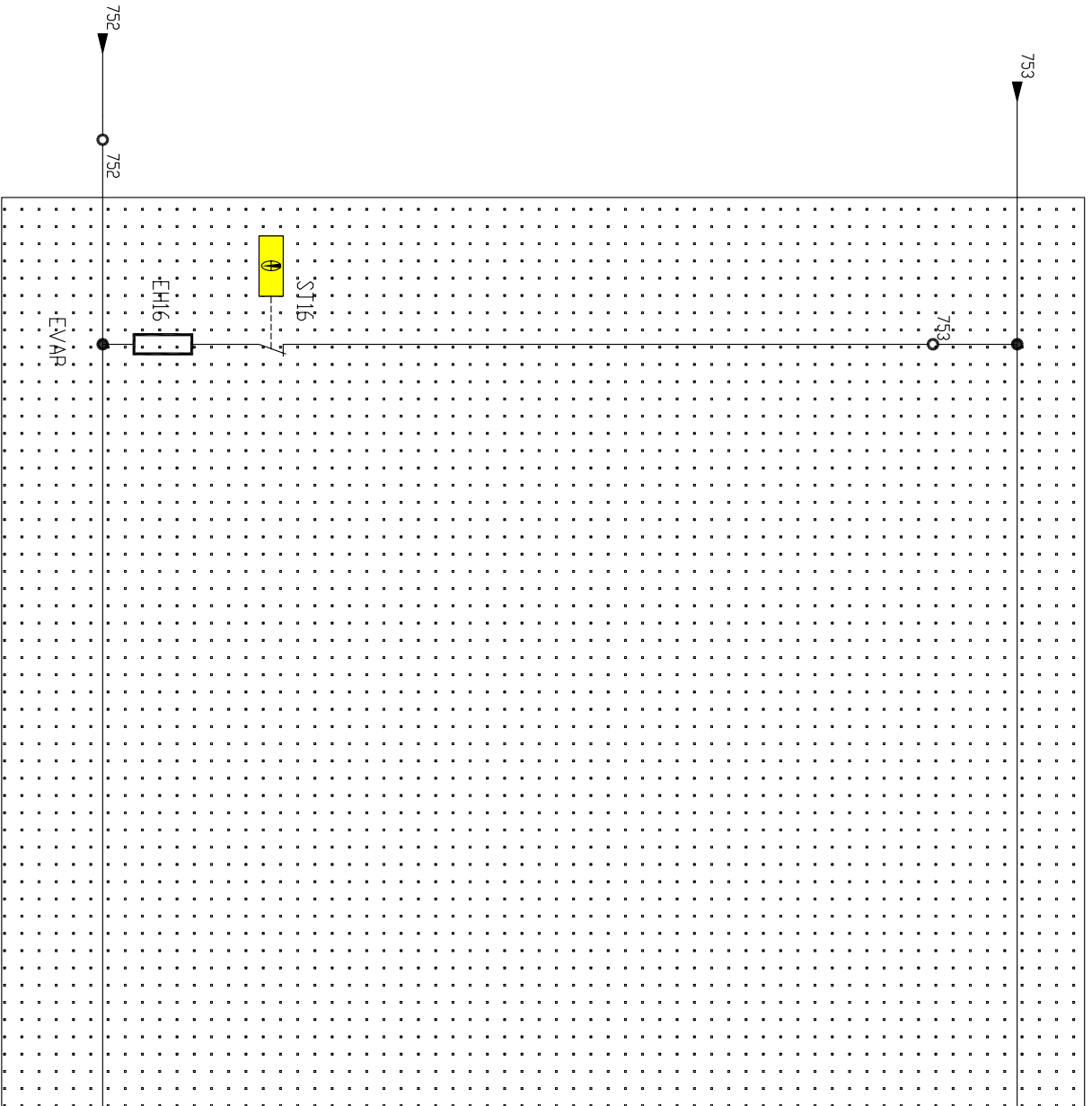

SCHEMA ELECTRIQUE

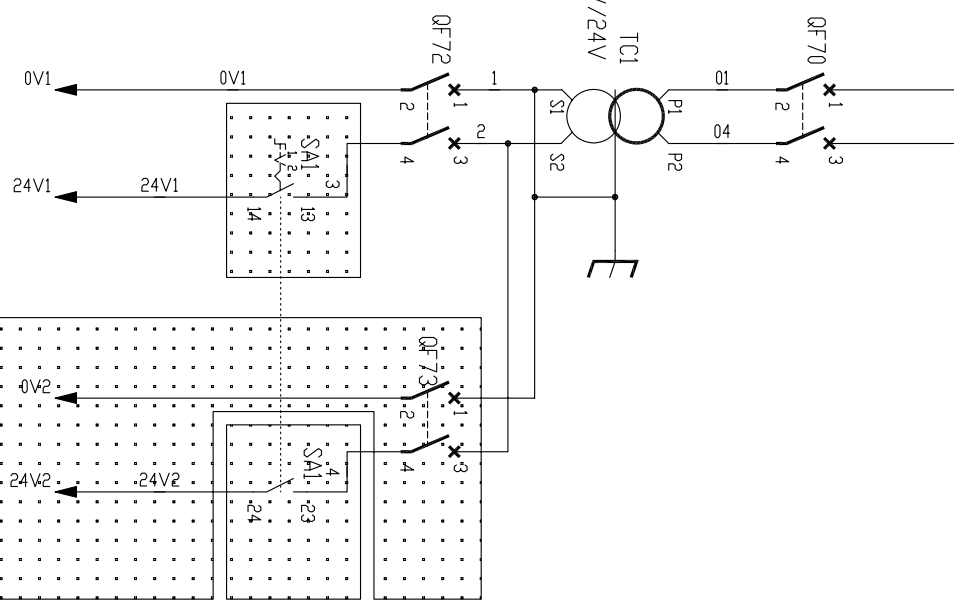
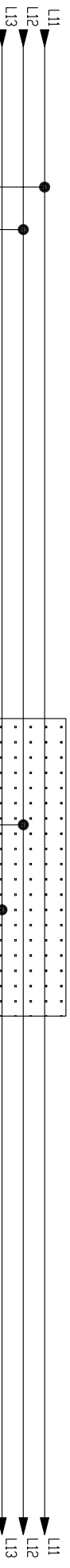

IF NO OPTION
 MAINS SWITCH
 SA1 DOOR MOUNTED
 SI PAS OPTION
 INTERRUPTEUR AG
 SA1 SUR PORTE

SI POWER
 TRANSFD >250 VA
 SI PUISSANCE
 TRANSFD >250 VA

CONTROL POWER SUPPLY
 ALIMENTATION CONTRÔLE

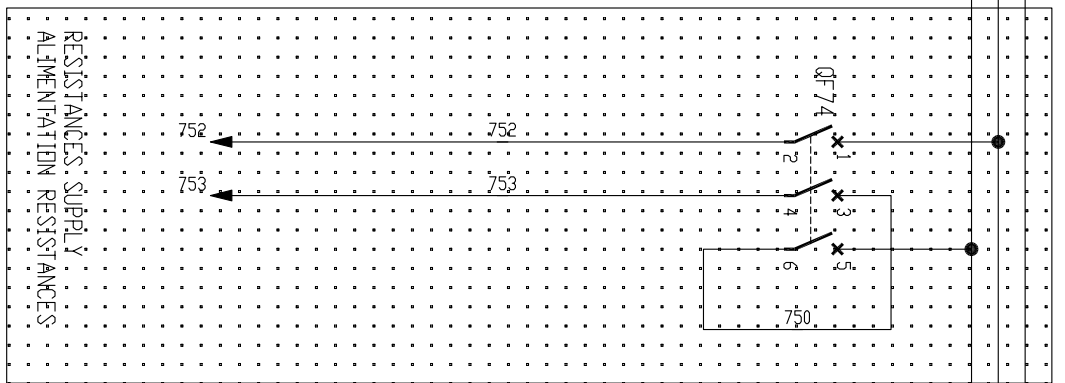

RESISTANCES SUPPLY
 ALIMENTATION RESISTANCES

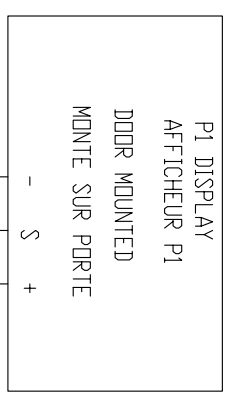

CONTROL BOARD
 MOUNTED ON AP1
 CARTE REGULATION
 MONTÉE SUR AP1

SCHEMA ELECTRIQUE

.IF: SOFT-STARTER OPTION: LH4: KM1: --> KAI1
 .SI: option: mémoriser: LH4: : KM2: --> KAI2

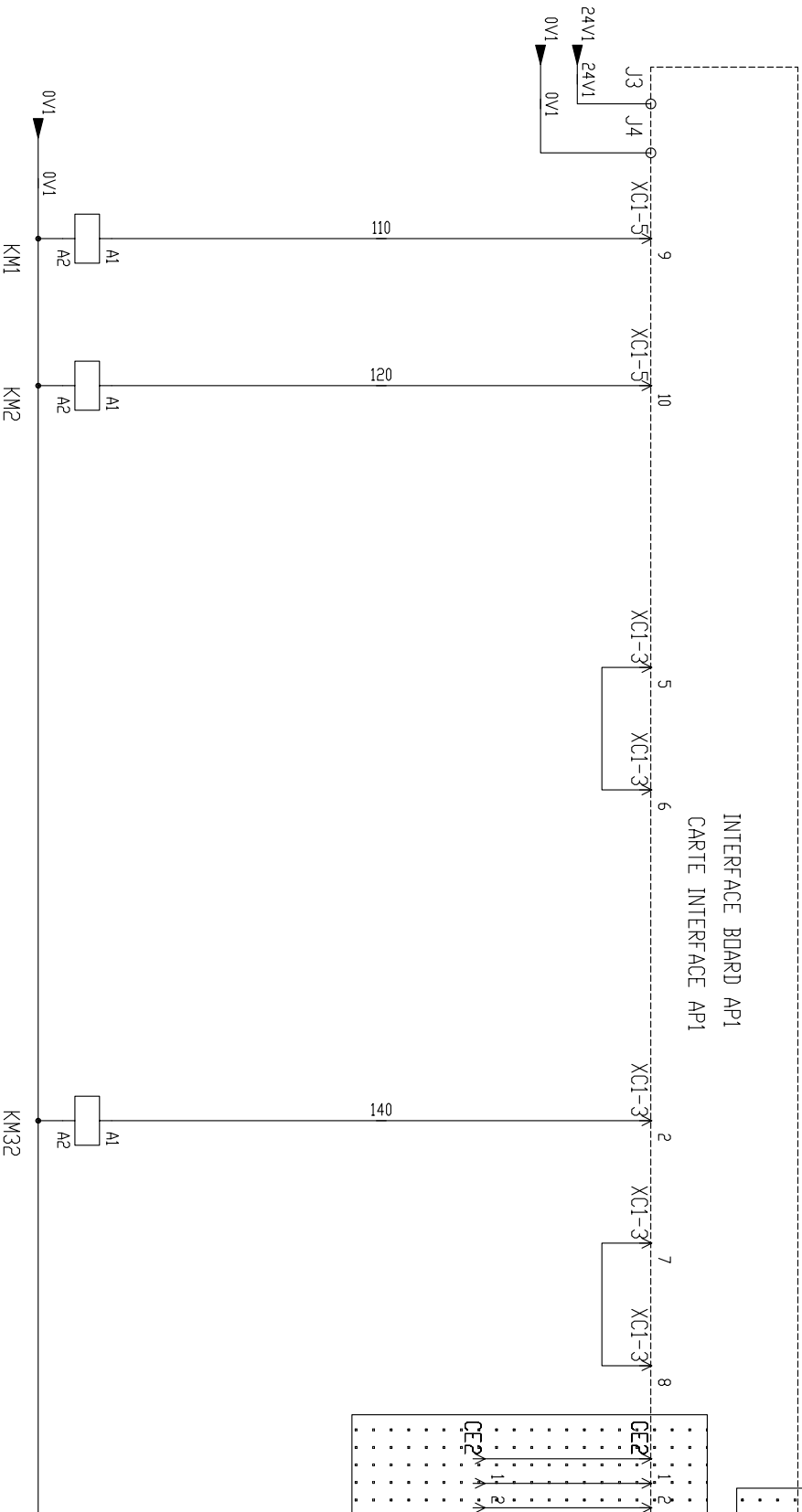

INTERFACE BOARD AP1
 CARTE INTERFACE AP1

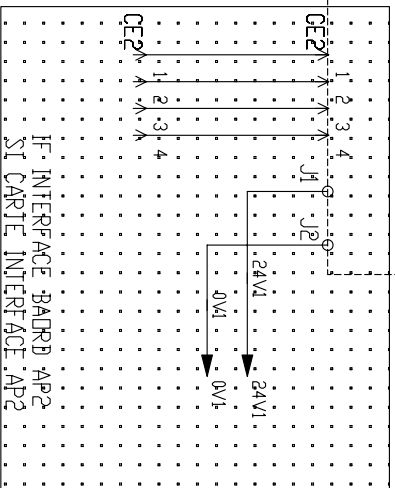
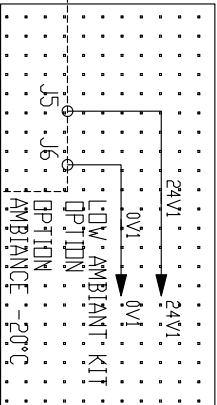

SCHEMA ELECTRIQUE

.I: S0FT-STARTER OPTI0N LHM: KM3 --> KA13 .
 .S: opti0n de m0d0le LHM: KM4 --> KA14 .

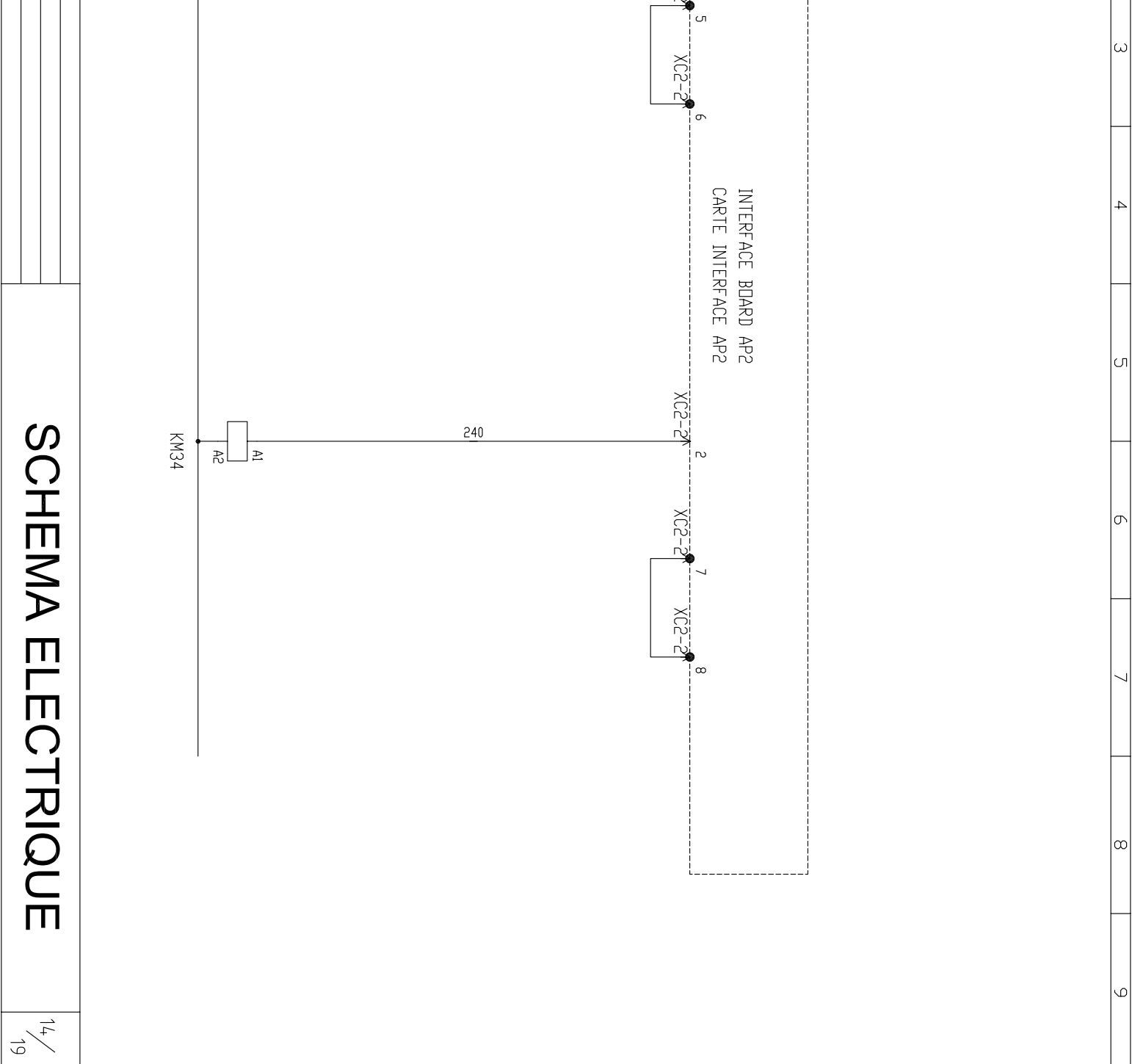

SCHEMA ELECTRIQUE

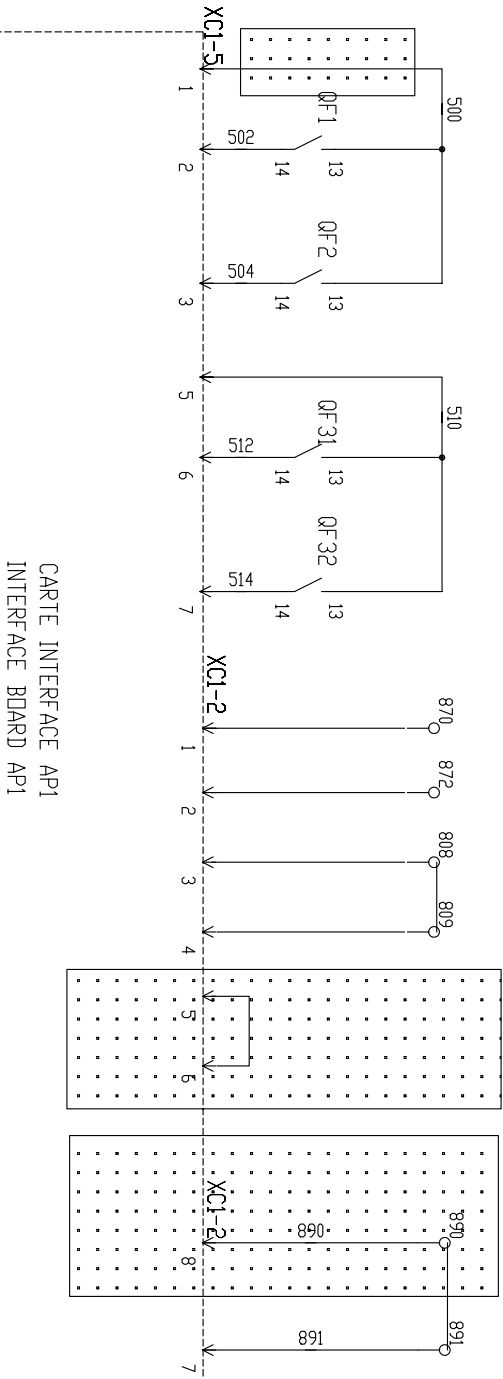

CARTIE INTERFACE API
INTERFACE BOARD API

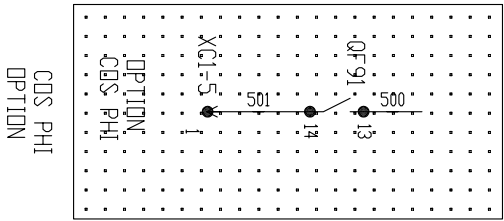

CDS PHI
OPTIION

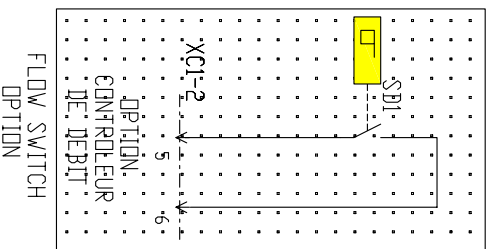

FLOW SWITCH
OPTIION

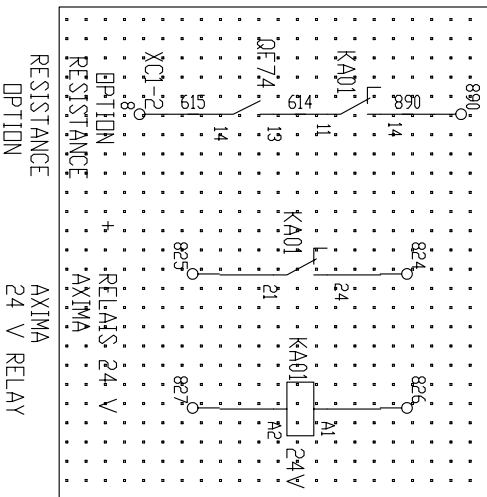

RESISTANCE
OPTIION
AXIMA
24 V RELAY

SCHEMA ELECTRIQUE

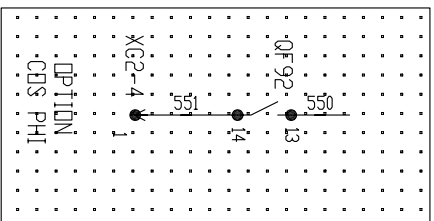
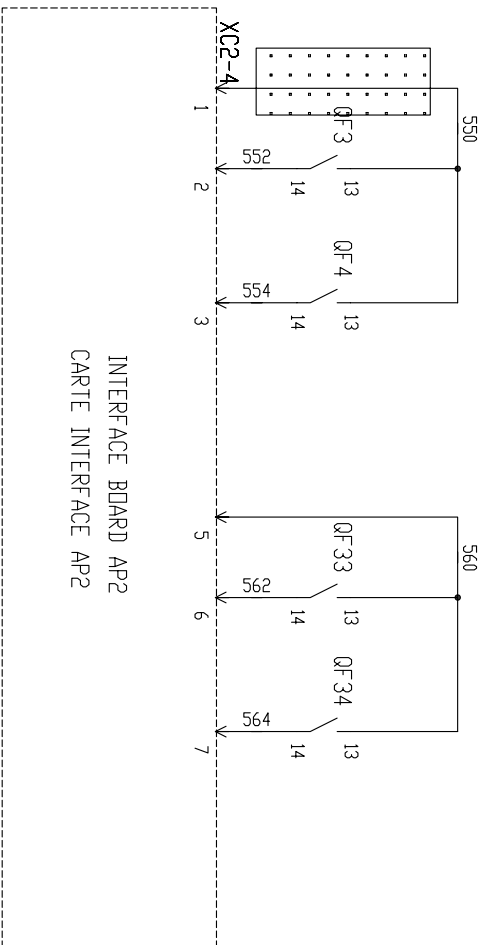

SCHEMA ELECTRIQUE

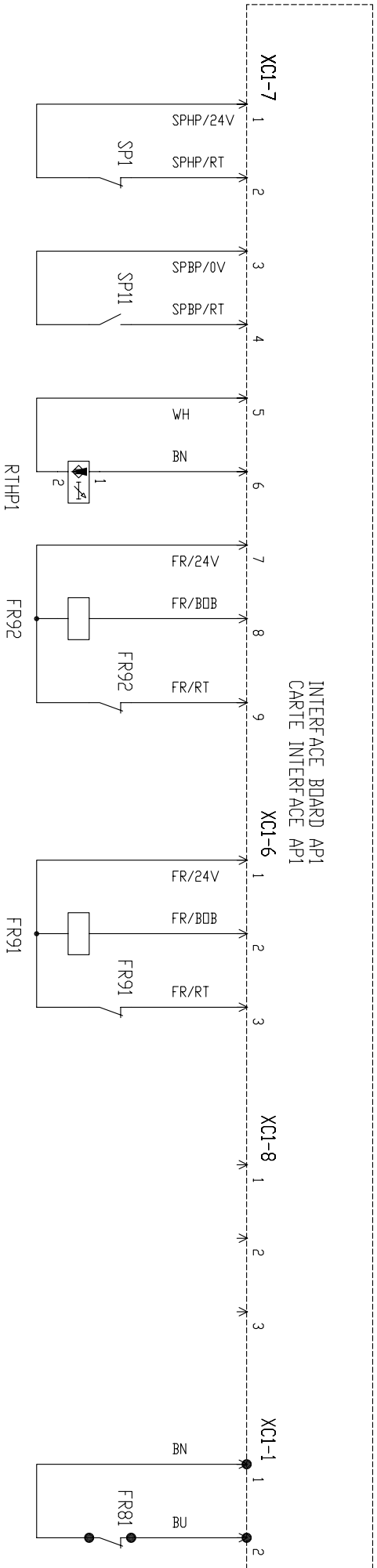

SCHEMA ELECTRIQUE

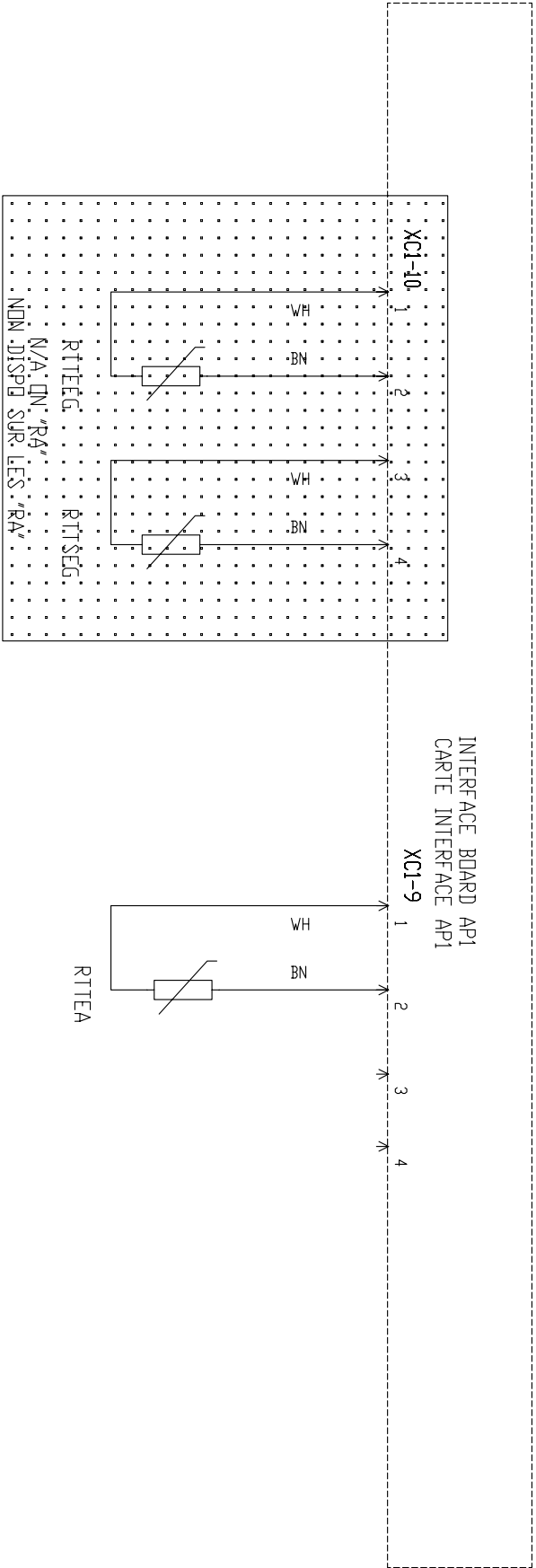

SCHEMA ELECTRIQUE

INTERFACE BOARD AP2
 CARTE INTERFACE AP2

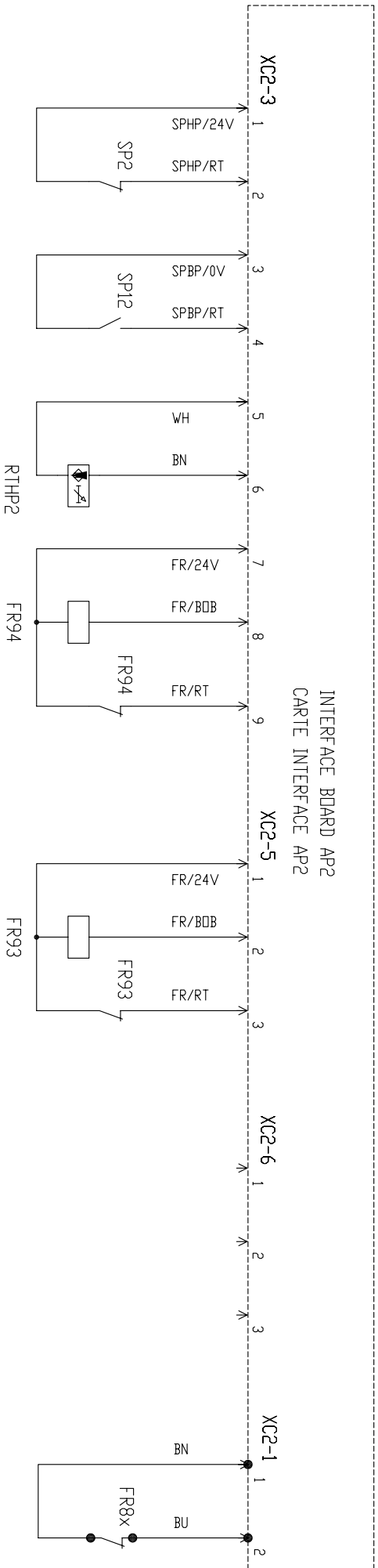

x = 3 IF 4 FAN MOTORS / Si 4 Moto - Ventilateur
 x = 4 IF 6 FAN MOTORS / Si 6 Moto - Ventilateur

SCHEMA ELECTRIQUE