

DOSSIER ELECTRIQUE

ELECTRICAL FILE

A	25-02-03	Y-D	MISE A JOUR FOLIO 10
Indice / Index	Date	Nom / Name	Modifications

LENNOX®

WA 130D K LN
LENNOX UK

Nom: / Name:
Y-D
Date:
21-01-2003

SE22917

0 / 14

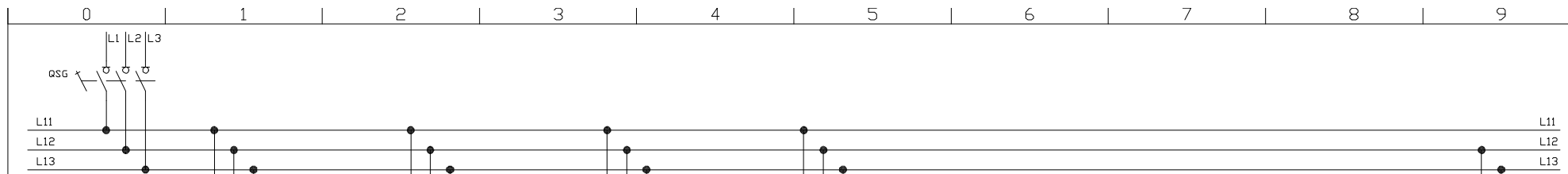

400V
3.50Hz
P max
66kW
I max
113A
I dem
195A

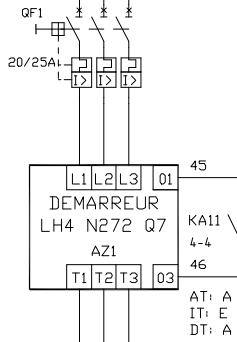

3x 6 mm2
 I 23A
 4x 6 mm2

SZ160
P= 14.5 kW
In=24.3 A
Id= 90 A

M1

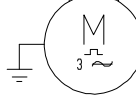
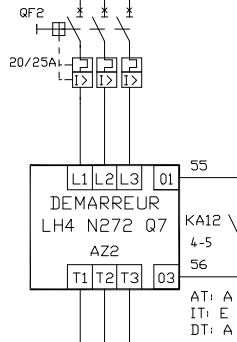

3x 6 mm2
 I 23A
 4x 6 mm2

SZ160
P= 14.5 kW
In=24.3 A
Id= 90 A

M2

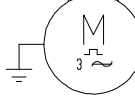
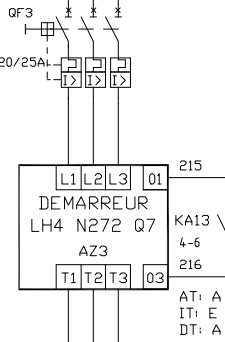

3x 6 mm2
 I 23A
 4x 6 mm2

SZ160
P= 14.5 kW
In=24.3 A
Id= 90 A

M3

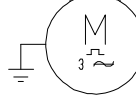
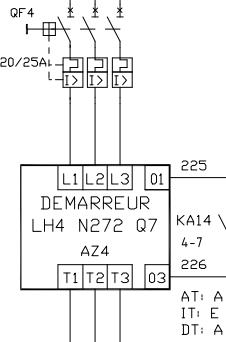

3x 6 mm2
 I 23A
 4x 6 mm2

SZ160
P= 14.5 kW
In=24.3 A
Id= 90 A

M4

QF1
NO NF
8-1

QF2
NO NF
8-2

QF3
NO NF
8-5

QF4
NO NF
8-6

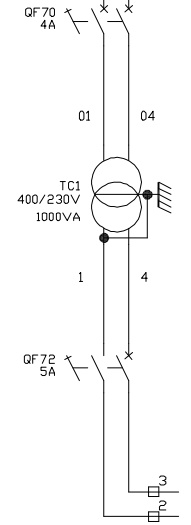

ATTENTION
 LES COMPRESSEURS
 MANEUROP SCROLL
 N'ONT QU'UN SEUL
 SENS DE ROTATION
 POUR FONCTIONNER

SE22917

Indice	DATE	NOM	MODIFICATIONS

SCHEMA ELECTRIQUE

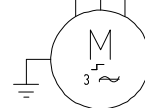
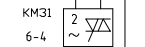
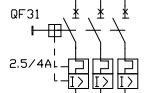

3x 1.5 mm²
 I 4A
 4x 1.5 mm²

FE071-VDQ-6N5
P= 1.7 kW
In=2.9 A
Id= A

M31

QF31
NO NF
5-2

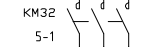
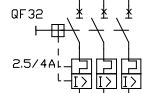

3x 1.5 mm²
 I 4A
 4x 1.5 mm²

FE071-VDQ-6N5
P= 1.7 kW
In=2.9 A
Id= A

M32

QF32
NO NF
5-1 10-1

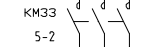
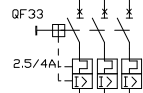

3x 1.5 mm²
 I 4A
 4x 1.5 mm²

FE071-VDQ-6N5
P= 1.7 kW
In=2.9 A
Id= A

M33

QF33
NO NF
5-2 10-2

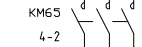
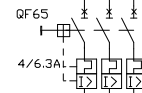

3x 1.5 mm²
 I 6.3A
 4x 1.5 mm²

LPD80-125/117
P= 2.2 kW
In=5.1 A
Id= 39 A

M65

QF65
NO NF
7-3

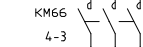
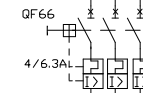

3x 1.5 mm²
 I 6.3A
 4x 1.5 mm²

LPD80-125/117
P= 2.2 kW
In=5.1 A
Id= 39 A

M66

QF66
NO NF
7-3

SE22917

Indice	DATE	NOM	MODIFICATIONS

SCHEMA ELECTRIQUE

LIAISON
CONSOLE (J22)

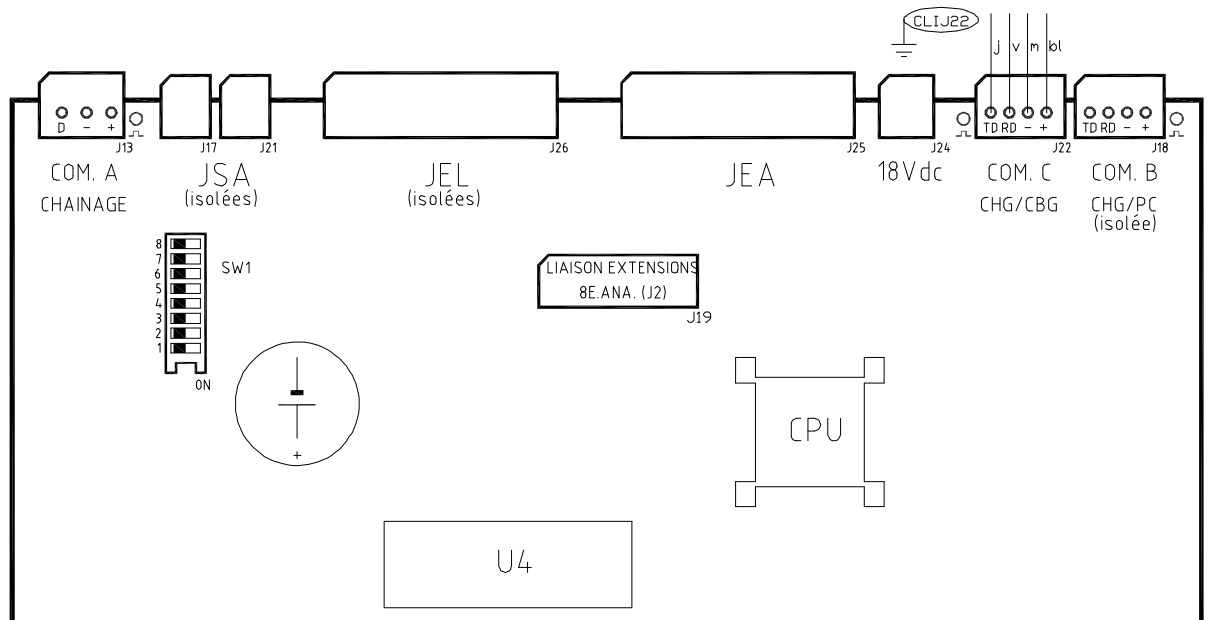
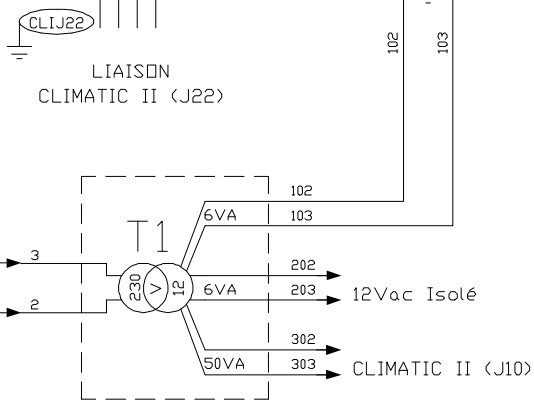
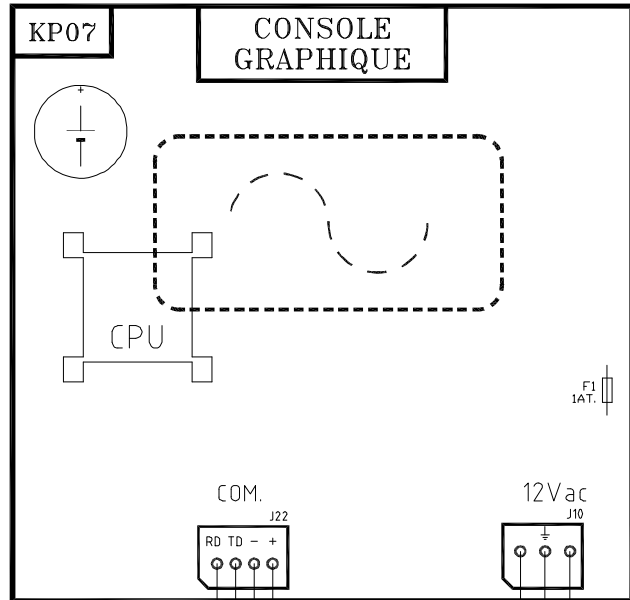

CLIMATIC II

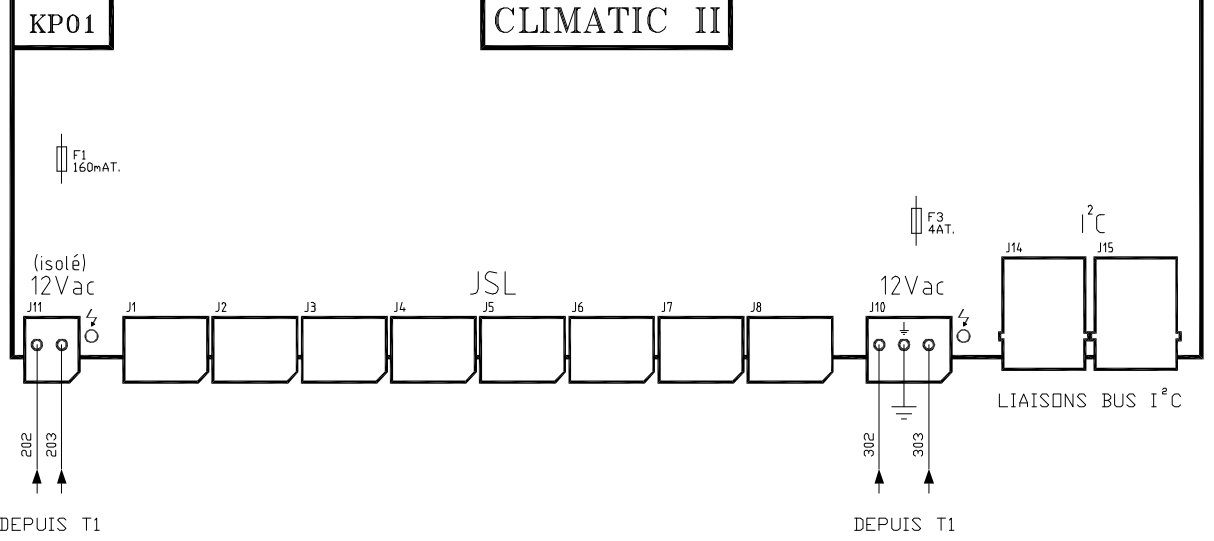

SE22917

Indice	DATE	NOM	MODIFICATIONS

SCHEMA ELECTRIQUE

0 1 2 3 4 5 6 7 8 9

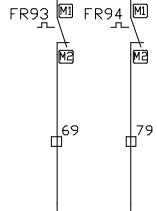
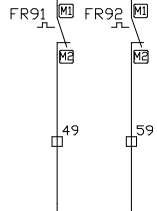
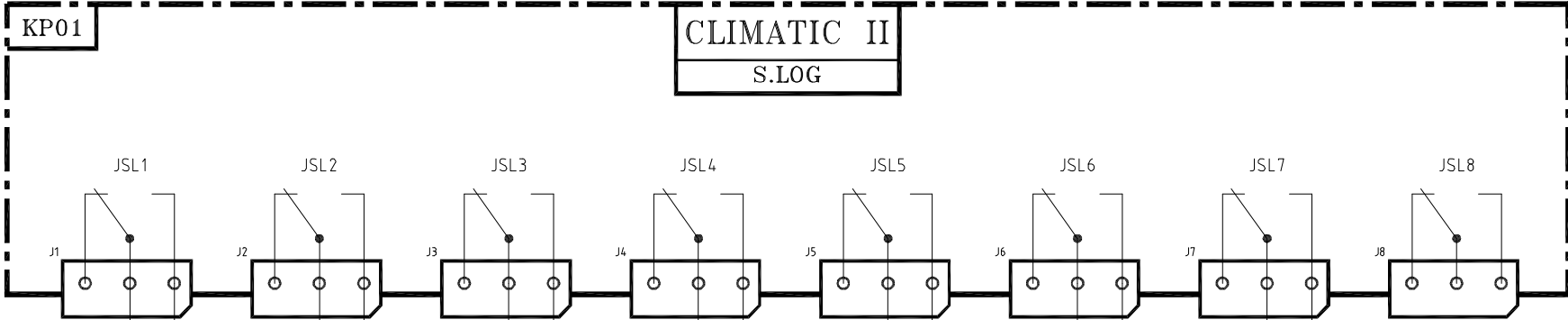

KA91	
NO	NF
8-2	

KA92	
NO	NF
8-2	

KA61	
NO	NF
10-3	10-3
	10-1
	10-1

KM65	
NO	NF
2-6	
2-6	
2-7	
2-6	

KM66	
NO	NF
2-7	
2-7	
10-0	
1-2	

KA11	
NO	NF
8-0	10-8
10-1	
1-2	

KA12	
NO	NF
8-1	10-8
10-1	
1-3	

KA13	
NO	NF
8-4	10-9
10-1	
1-4	

KA14	
NO	NF
8-4	10-9
10-2	
1-5	

KA93	
NO	NF
8-5	

KA94	
NO	NF
8-6	

SE22917

Indice	DATE	NOM	MODIFICATIONS

SCHEMA ELECTRIQUE

0 | 1 | 2 | 3 | 4 | 5 | 6 | 7 | 8 | 9

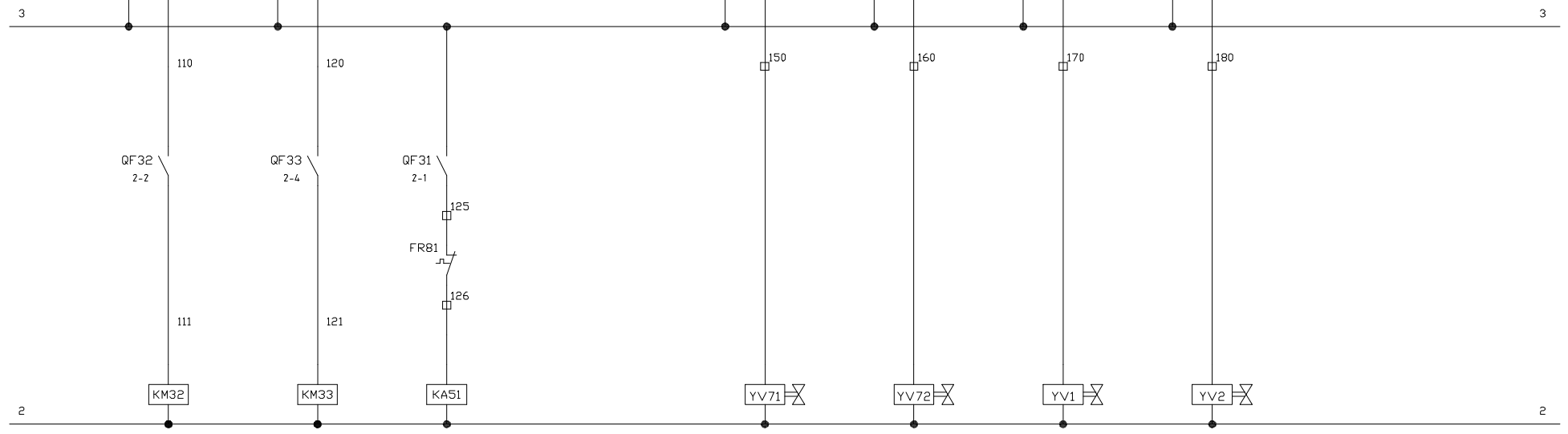
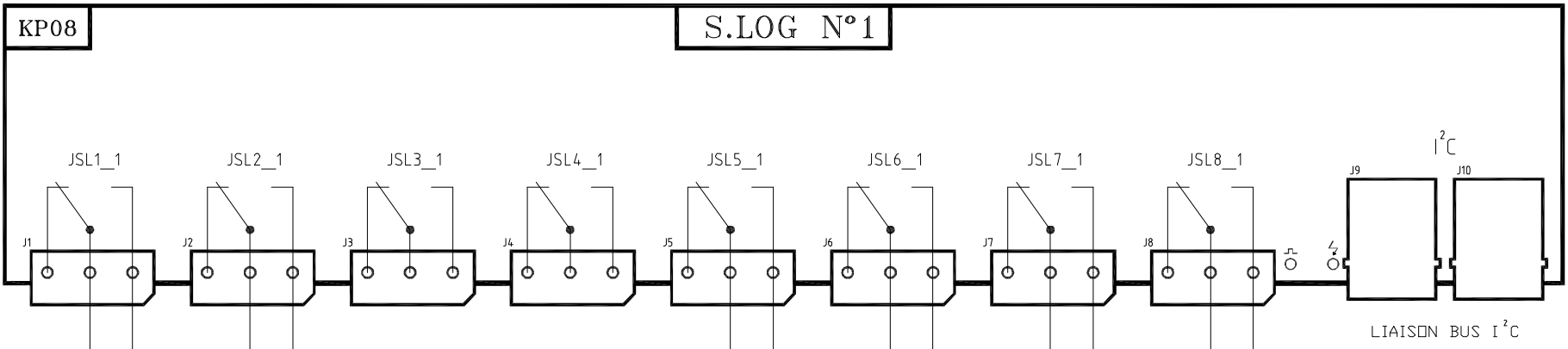

KM32	
NO	NF
2-2	
2-2	
2-2	

KM33	
NO	NF
2-4	
2-4	
2-4	

KA51	
NO	NF
6-4	10-1

SE22917

Indice	DATE	NOM	MODIFICATIONS

SCHEMA ELECTRIQUE

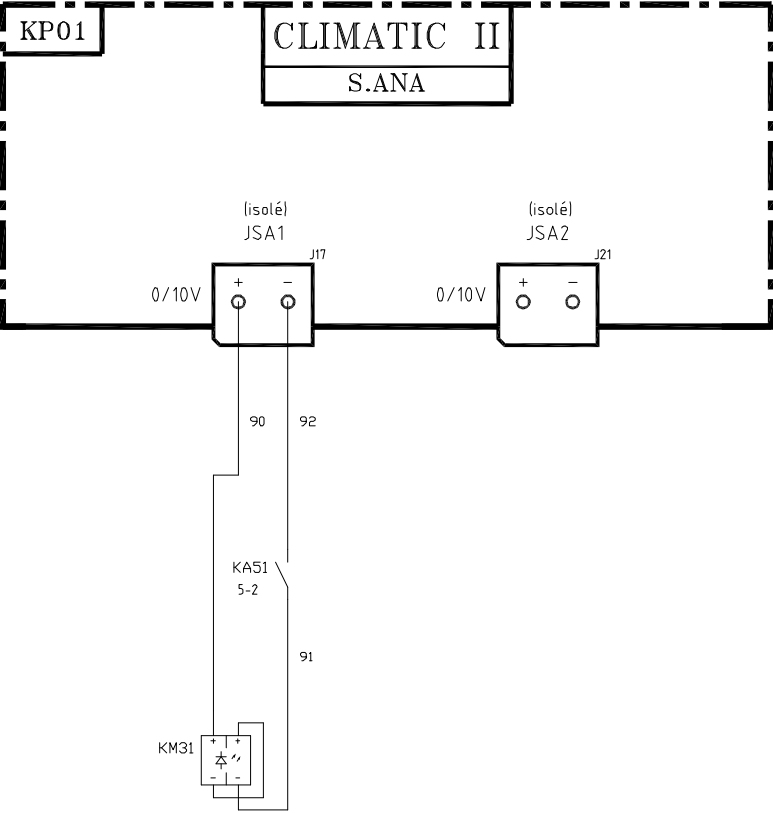

KM31	
NO	NF
2-1	

SE22917

Indice	DATE	NOM	MODIFICATIONS

SCHEMA ELECTRIQUE

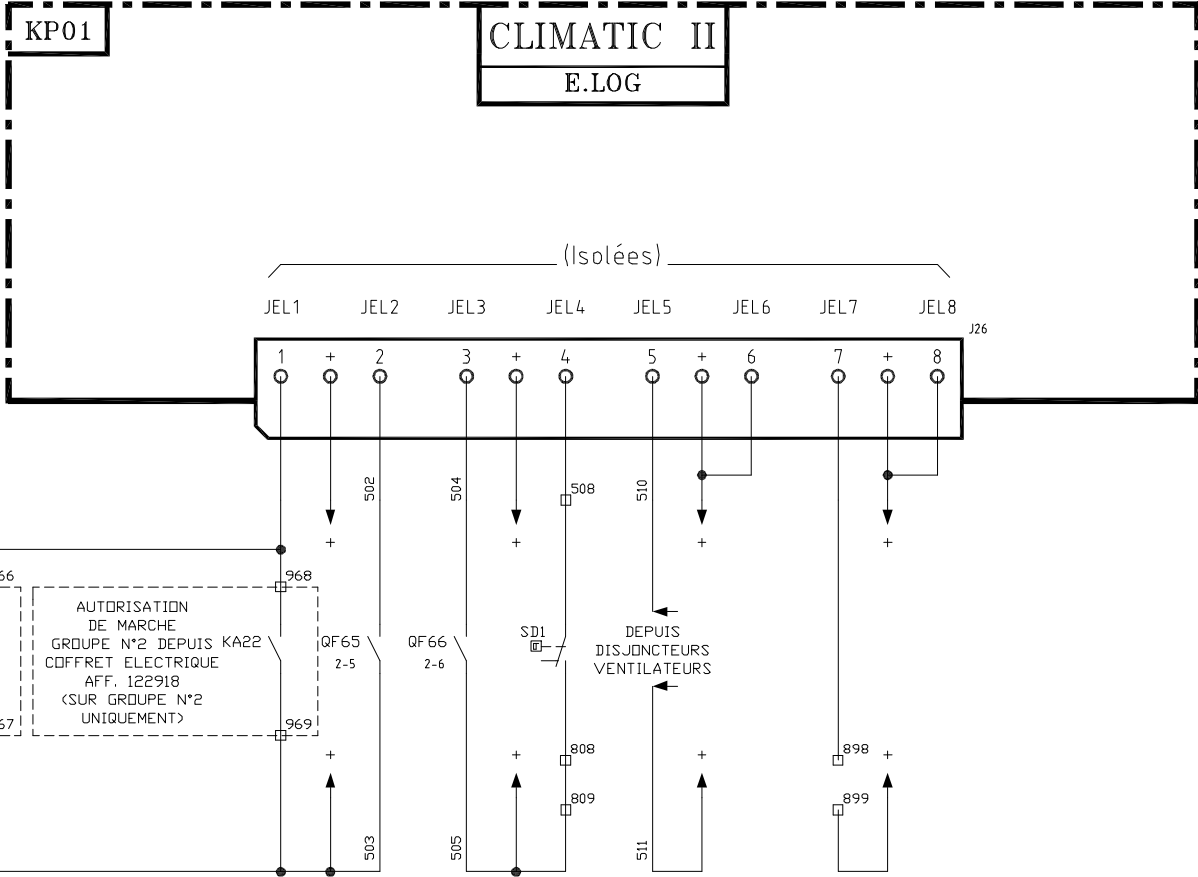

SE22917

Indice	DATE	NOM	MODIFICATIONS

SCHEMA ELECTRIQUE

KP03

E.LOG N°1

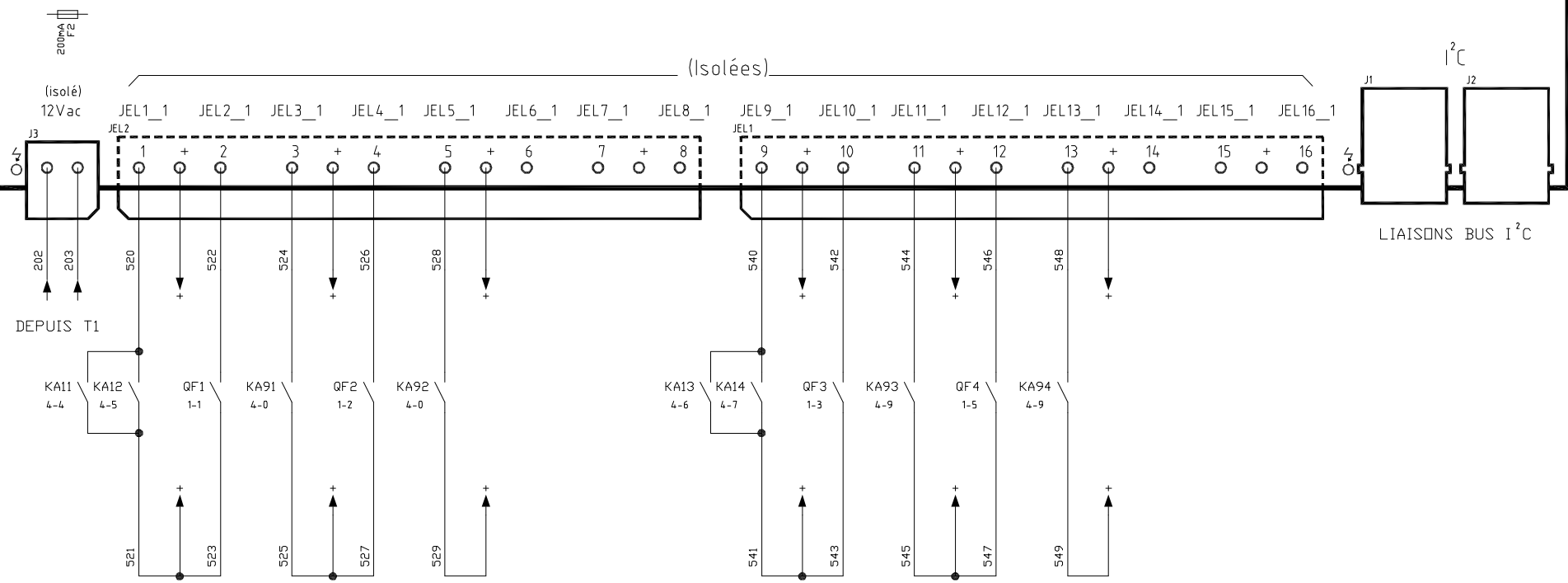

SE22917

Indice	DATE	NOM	MODIFICATIONS

SCHEMA ELECTRIQUE

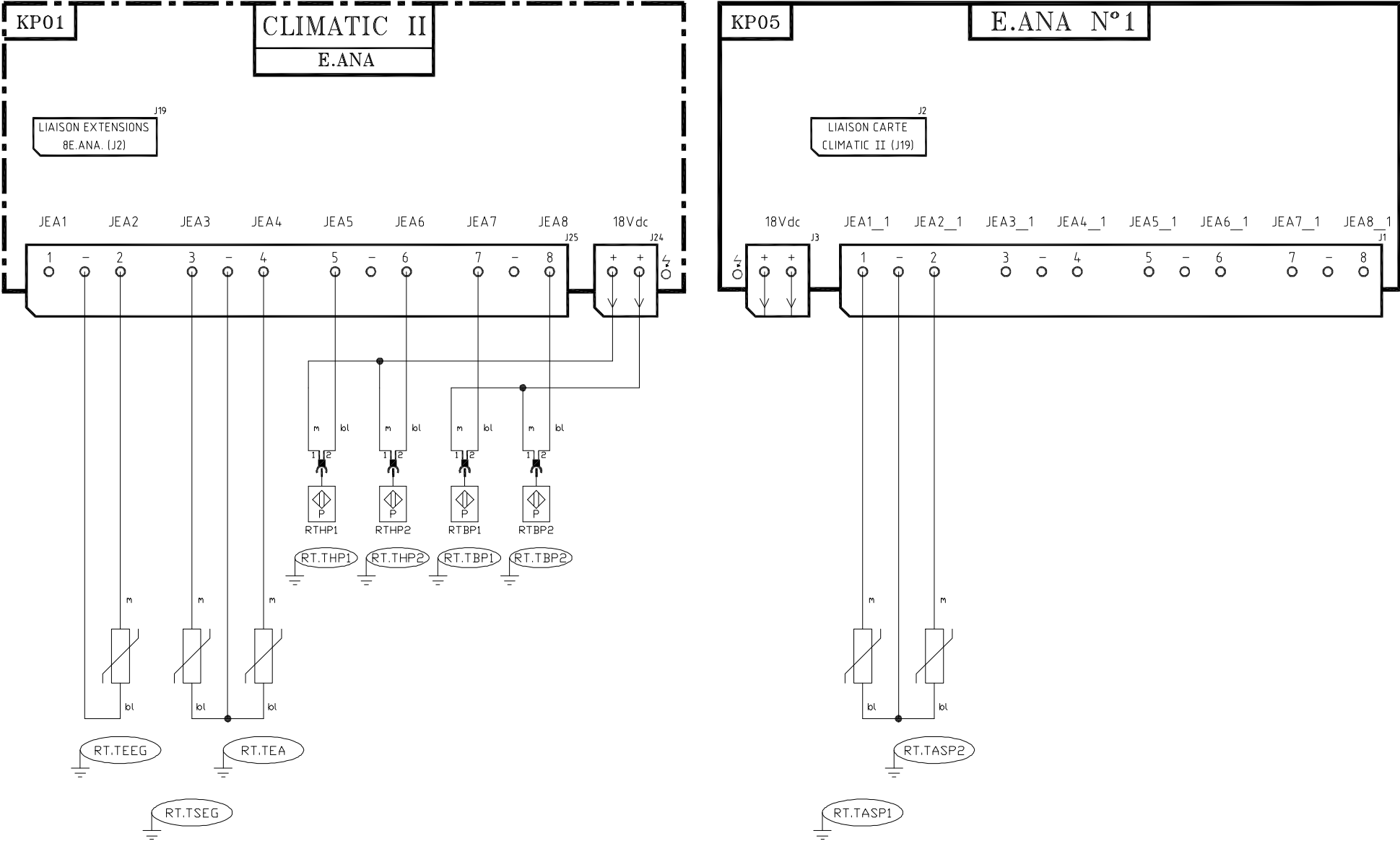

SE22917

Indice	DATE	NOM	MODIFICATIONS

SCHEMA ELECTRIQUE

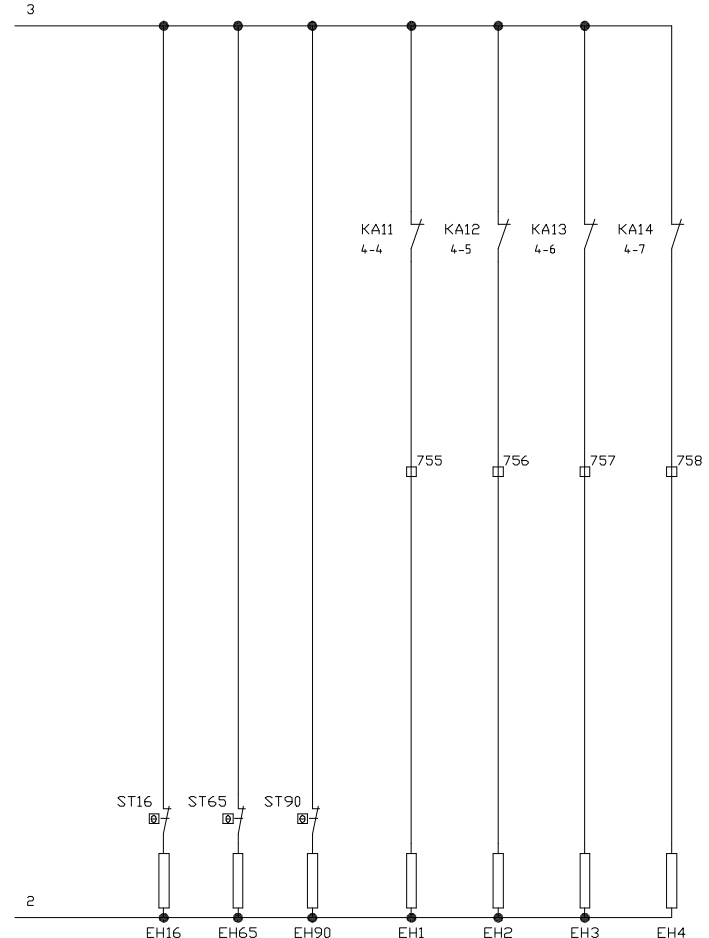
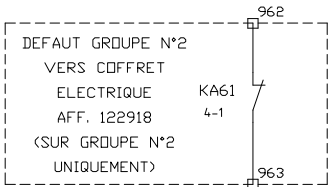
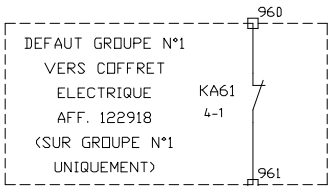
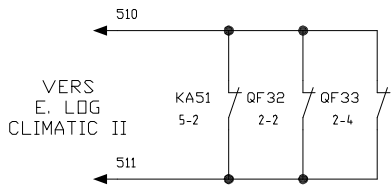
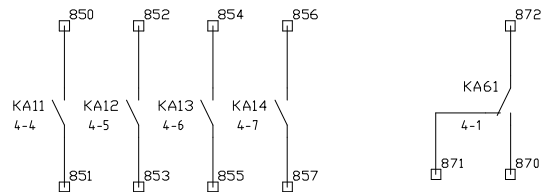

FR91	FR92	FR93	FR94
NO NF	NO NF	NO NF	NO NF
4-0	4-0	4-9	4-9

SE22917

A	25-02-03	Y-D	SUPPRESSION BOBINES DE KRIWAN
Indice	DATE	NOM	MODIFICATIONS

SCHEMA ELECTRIQUE

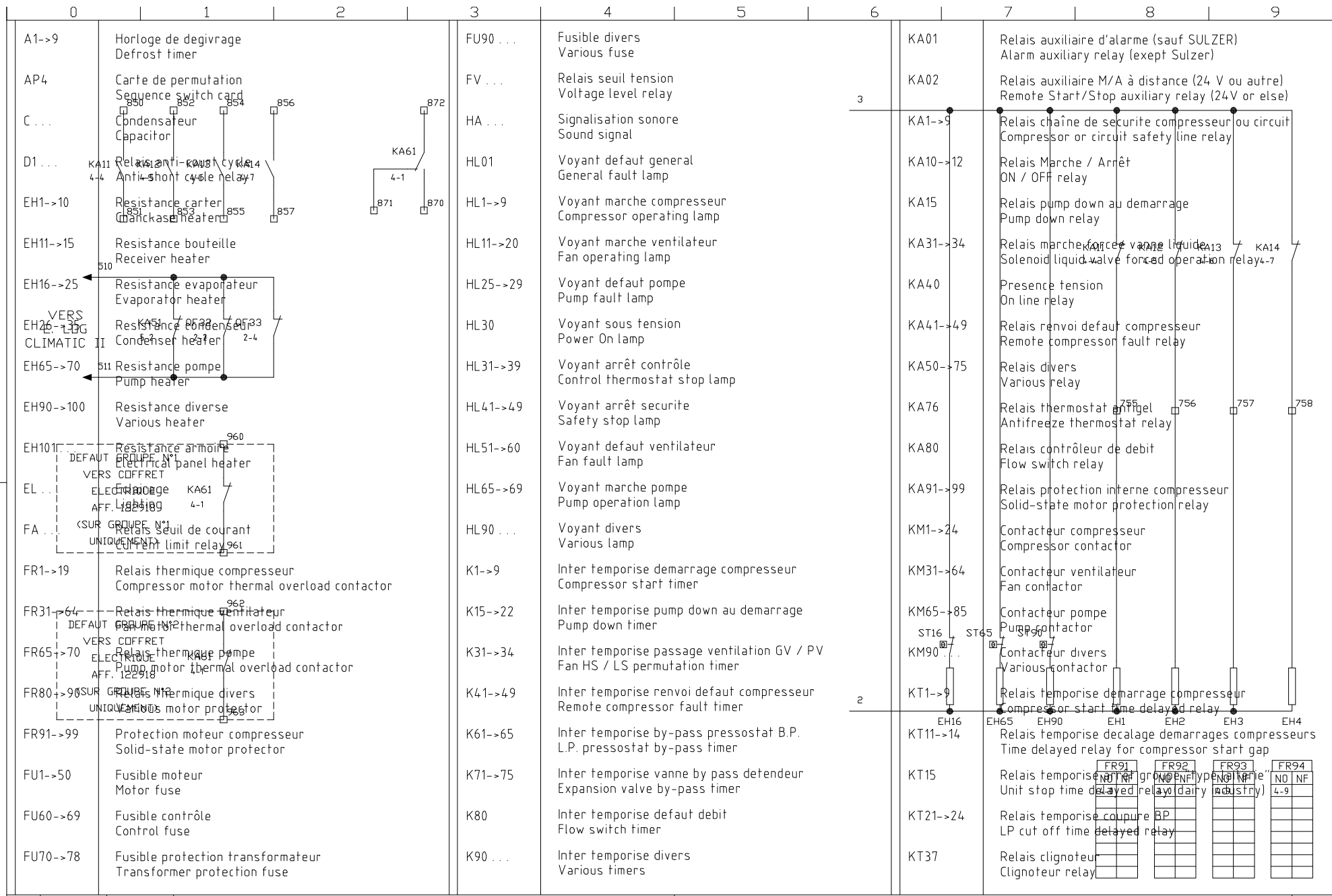

SE22917

A	25-02-03	Y-D	SUPPRESSION BOBINES DE KRIWAN
Indice	DATE	NOM	MODIFICATIONS

SCHEMA ELECTRIQUE

0	1	2	3	4	5	6	7	8	9
KT41->49	Relais temporise renvoi défaut Remote fault time delayed relay		QF70->89	Disjoncteur protection circuit commande Control circuit protection circuit breaker		SA11	Interrupteur local/distance Local/remote switch		
KT90 ...	Relais temporise divers Various time delayed relay		QF90 ...	Disjoncteur divers Various circuit breaker		SA12->16	Interrupteur marche pompe Pump on/off switch		
M1->9	Compresseur Compressor motor		QS1->30	Porte fusible compresseur Compressor fuse breaker		SA17	Permutateur compresseur Compressor permutation switch		
M11->M15	Anti-court cycle Anti-short cycle		QS31->64	Porte fusible ventilateur Fan fuse breaker		SA18-19	Permutateur pompe Pump permutation switch		
M31->64	Ventilateur Fan motor		QS65->69	Porte fusible pompe Pump fuse breaker		SA20	Permutateur ete/hiver Summer/winter switch		
M65->70	Pompe Pump		QS90 ...	Porte fusible divers Various fuse breaker		SA21	Permutateur M/A klaxon Horn switch ON/OFF		
M90->100	Moteur divers Various motors		QSG	Interrupteur general Main power interrupter		SA90 ...	Interrupteur divers Various switches		
M101-102	Ventilateur d'armoire Electrical panel fan		┌ └	ouSectionneur general orMain power switch		SB1	Bouton poussoir hors tension Off line push button		
M111->109	Ventilateur de culasse compresseur Compressor cylinder head fan			ouDisjoncteur general orMain power circuit breaker		SB2	Bouton poussoir sous tension On line push button		
CHILLER	Regulateur Regulator		R ...	Resistance triphasee 3 phase heater		SB3->6	Bouton poussoir marche Start push button		
┌ AP2	Module supplementaire (CP2) Extra regulator module (CP2)		RC ...	Circuit RC RC circuit		SB7->9	Bouton poussoir arrêt Stop push button		
└ AP31-32 (RV1-2)	Relais de commande ventilateur monophasé Command relay for single phase fan motor		RT ...	Sonde ou capteur Temperature or pressure sensor		SB10	Bouton poussoir arrêt d'urgence Emergency stop push button		
└ AP1	Module de base (CP1) Basic module (CP1)		RTTEA	Temperature d'entree d'air Air inlet temperature		SB11	Bouton poussoir arrêt klaxon Horn stop push button		
P1 ...	Afficheur D27 ou PC905 D27 or PC905 display		RTTEEG	Temperature d'entree d'eau glatee Cold water inlet temperature		SB12	Bouton poussoir test lampe Lamp test push button		
PA ...	Ampèremètre Ammeter		RTTSEG	Temperature de sortie d'eau glatee Cold water outlet temperature		SB16->24	Bouton poussoir rearmement huile Oil pressostat reset push button		
PJ ...	Wattmètre (compteur d'energie) Wattmeter		RTTREF ...	Temperature de refoulement Discharge temperature		SB25->29	Bouton poussoir arrêt pompe Pump stop push button		
PT1->9	Compteur horaire Hour meter		RTTASP ...	Temperature d'aspiration Suction temperature		SB41	Bouton poussoir effacement défaut Fault reset push button		
PV ...	Voltmètre		RTTBP ...	Temperature d'évaporation Evaporating temperature		SB65->69	Bouton poussoir marche pompe Start pump push button		
QF1->14	Disjoncteur compresseur Compressor circuit breaker		RV1 ...	Variateur de vitesse Speed regulator		SB76->80	Bouton poussoir rearmement antigel Antifreeze reset push button		
QF31->64	Disjoncteur ventilateur Fan circuit breaker		SA1->5	Interrupteur sous tension On-off switch		SB90	Bouton poussoir divers Various push button		
QF65->69	Disjoncteur pompe Pump circuit breaker		SA6->10	Interrupteur marche circuit Circuit start switch		SD1 ...	Contrôleur de debit Flow switch		

SE22917

Indice	DATE	NOM	MODIFICATIONS

SCHEMA ELECTRIQUE

13 / 14

0	1	2	3	4	5	6	7	8	9
SL1->5	Contrôleur de niveau d'eau Water level controller		ST36->40	Thermostat depart d'eau Water outlet thermostat		YV36->40	Electrovanne gaz chauds pressostatique Pressostatic hot gas solenoid valve		
SL16->20	Contrôleur de niveau d'huile Oil level controller		ST41->45	Thermostat retour d'eau Water inlet thermostat		YV41->45	Electrovanne gaz chauds thermostatique Thermostatic hot gas solenoid valve		
SP1->9	Pressostat HP securite HP pressostat		ST46->55	Thermostat d'huile Oil thermostat		YV46->50	Electrovanne decharge bouteille Receiver by-pass valve		
SP11->15	Pressostat BP securite LP pressostat		ST56->64	Thermostat de surchauffe Overheat thermostat		YV51->55	Electrovanne aspiration Suction solenoid valve		
SP16->25	Pressostat d'huile Oil pressostat		ST71->75	Thermostat de degivrage Defrosting thermostat		YV56->60	Electrovanne by pass condenseur (ete/hiver) Condenser by-pass solenoid valve (winter/summer)		
SP26->30	Pressostat BP antigel Antifreeze pressostat		ST76->85	Thermostat antigel Antifreeze thermostat		YV61->70	Electrovanne inversion cycle Reverse cycle solenoid valve		
SP31->50	Pressostat HP de commande ventilateur Fan control HP pressostat		ST90->100	Thermostat divers Various thermostat		YV71->75	Electrovanne by pass detendeur Expansion valve by-pass solenoid valve		
SP51->55	Pressostat HP de commande resistance bouteille Receiver heater control pressostat		ST101...	Thermostat resistance et ventilateur d'armoire Electrical panel fan and heater control thermostat		YV90...	Electrovanne diverse Various solenoid valve		
SP56->60	Pressostat HP de commande vanne decharge bouteille Discharge valve control pressostat		T1...	Transformateur CLIMATIC CLIMATIC transformer					
SP61->65	Pressostat HP de commande delestage Overload control pressostat		TA...	Transformateur d'intensite Current transformer					
SP66->70	Pressostat HP de commande degivrage Defrosting pressostat		TC1...	Transformateur Transformer					
SP71->75	Pressostat de commande by-pass detendeur Expansion valve by-pass control pressostat		V...	Diode Diode					
SP90->110	Pressostat divers Various pressostat		VOPT...	Optocoupleur Optoelectronic coupler					
SP111->115	Pressostat HP/BP combine HP/LP pressostat		XB...	Barette sectionnable Isolator link					
SQ1...	Contact de porte Door contact		XS90...	Prise de courant Plug					
SR91...	Contrôleur de phase Phase controller		YP1...	Detendeur electronique Electronic expansion valve					
ST1->5	Thermostat de contrôle Control thermostat		YV1->5	Electrovanne liquide Liquid solenoid valve					
ST11->15	Thermostat de commande resistance bouteille Receiver heater control thermostat		YV6->15	Electrovanne reduction de puissance compresseur Compressor capacity control valve					
ST16->25	Thermostat de commande resistance evaporateur Evaporator heater control thermostat		YV16->20	Electrovanne injection de liquide Liquid injection solenoid valve					
ST26->30	Thermostat de commande resistance condenseur Condenser heater control thermostat		YV21->25	Electrovanne economiseur Economizer solenoid valve					
ST31->35	Thermostat de commande ventilateur Fan control thermostat		YV26->35	Electrovanne by-pass compresseur Compressor by-pass solenoid valve					

SE22917

Indice	DATE	NOM	MODIFICATIONS

SCHEMA ELECTRIQUE

14/14