

LENNOX[®]

CLIMATIC[™] USER MANUAL



PROVIDING **GLOBAL SYSTEM SOLUTIONS**

CHILLERS
V 2.4

GENERAL CONTENTS

	Page
CONTROL AND REGULATION.....	2
OPTIONS.....	14
MACHINE FAULTS.....	24
CIRCUIT FAULTS.....	31
COMPRESSOR FAULTS	38
MISCELLANEOUS FAULTS	44
KP02 DIGITAL CONSOLE	51
VISUAL DISPLAY UNIT (VDU) KP 07	56
ELECTRONIC CARD DATA	81

CONTROL AND REGULATION

CONTENTS

	Page
IDLE FUNCTION	3
CONTROL OF EVAPORATOR PUMPS	4
COLD THERMOSTAT	5
HOT THERMOSTAT.....	6
CONTROL OF COMPRESSORS.....	7
CONTROL OF CAPACITY REDUCTIONS FOR COLD REGULATION	8
CONTROL OF CAPACITY REDUCTIONS FOR HOT REGULATION	9
HP LOAD SHEDDING	10
CONTROL OF ELECTRONIC EXPANSION VALVE.....	11
CONTROL OF CONDENSER FANS	12
SPECIFIC VALVES FOR SCREW COMPRESSORS	13

IDLE FUNCTION

Function

The idle function enables the machine to be stopped during certain times of the day or certain days of the week. Outside the idle period, the refrigeration unit operates normally, in accordance with its instructions.

Description

Idle time is defined by 4 instructions (start instructions are included in the idle period, while end instructions are excluded):

- HDEBUTI ⇔ Start time of daily idle period
- HFINI ⇔ End time of daily idle period
- JDEBUTI ⇔ Start day of weekly idle period
- JFINI ⇔ End day of weekly idle period

As an option, the customer has the facility of confirming or stopping the idle function by remote control, by means of a hard contact connected to the logic input provided for this purpose (see wiring diagram). The variable associated with this entry is MAARI.

If MAARI = 0, idle times are inhibited.

If MAARI = 1, idle times are applied.

Example:

The user wishes to stop the machine:

- from Monday to Friday, from 7 p.m. to 6 a.m. the next morning
- all day on Saturday and Sunday.

In this case the instructions should be set as follows:

- HDEBUTI = 19
- HFINI = 6
- JDEBUTI = 7
- JFINI = 2

Note : By convention, Sunday is the first day of the week (Sunday = 1).

CONTROL OF EVAPORATOR PUMPS

Function

To control the flow of refrigerant in the evaporator

Description

There are two possible types of regulation, defined by the variable C2POMPE.

- ❶ If C2POMPE = 0, the CLIMATIC controls one pump or none.
- ❷ If C2POMPE = 1, the CLIMATIC controls two pumps in normal / standby mode.

The user configures the C2POMPE parameter through switch 1 (or SW1) of CPU card.

☞ Case ❶:

The pump POMPE1 is in service if all the following conditions are satisfied:

- ⇒ At least one on / off circuit n is ON (MAARn = 1). *
- ⇒ The remote on / off switch for the machine is ON (MAARD = 1). *
- ⇒ This is not an idle period (INOCCUP = 0). *
- ⇒ The pump has been off for 1 minute or is already in operation.
- ⇒ There is no electrical fault on the pump (DELECP1 = 1).
- ⇒ There is no flow fault on the pump (DSDEB1 = 0).

* This condition is not taken into account if the "anti-freeze pump start-up" option has been selected and the outside air temperature is less than 2°C.

POMPE1 is always controlled by the CLIMATIC even if the installation pump is not electrically controlled by the refrigeration unit.

If the customer controls the pump, he/she must comply with the following procedures:

- Pump start-up 1 minute before confirming the remote on / off switch for the unit.
- Pump off at least 2 minutes after MAARD is switched to 0.

☞ Case ❷:

The pump POMPEk is in service if:

- ⇒ At least one on / off circuit n is ON (MAARn = 1). *
- ⇒ The remote on / off machine is ON (MAARD = 1). *
- ⇒ This is not an idle period (INOCCUP = 0). *
- ⇒ Pump POMPEk has priority (PRIP = k-1).
- ⇒ The pump has been off for 1 minute or is already in operation.
- ⇒ There is no electrical fault on the pump (DELECPk = 1).
- ⇒ There is no flow fault on the pump (DSDEBk = 0).

* This condition is not taken into account if the "anti-freeze pump start-up" option has been selected and if the outside air temperature is less than 2°C.

The pump priority changes automatically once a week, on Monday at 6 p.m..

In the event of a fault occurring on the pump in service, the second pump automatically takes over, if it is available.

Note: The CLIMATIC waits 2 minutes before stopping the pumps after a request to stop the machine or circuits, to avoid any risk of the evaporator freezing.

COLD THERMOSTAT

Function

To bring the temperature of the cooled fluid as close as possible to the set point by adapting the number of compressors in service to the heat load in operation.

Description

The thermostat THER controls the switching on and off of compressors.

It is determined in accordance with the following parameters:

- TEEG ⇔ Chilled water input temperature (°C)
 CONSREG ⇔ Active instruction for output of chilled water (°C)
 The value of this instruction depends on the type of regulation required by the customer and the state of the logic input associated with the CHPCONS variable.

Option regulation with gradient	CHPCONS	Value of CONSREG
Not selected	0	CONSEA
	1	CONSEB
Selected (see page 15)	0	CONSEA
	1	CONSCALC = f(TEA)

- DELTAT ⇔ Desired temperature difference between water input and output (°C)
 ENCL ⇔ Operating differential for a regulation stage (°C)
 This variable is calculated as follows:
 $ENCL = (DELTAT / \text{No. Of compressors})$

Example of a machine with 4 compressors:

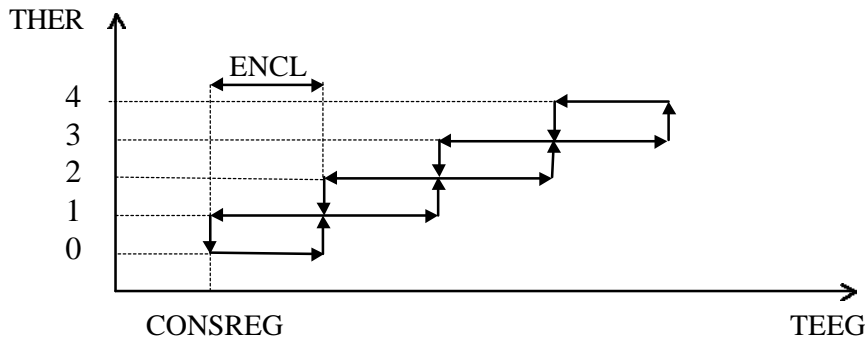

With CONSREG = 7°C
 and DELTAT = 5°C

⇒ ENCL = 1.25°C

Compressor start-up		Compressor stop	
THER	TEEG (°C)	THER	TEEG (°C)
0 ⇔ 1	8.25	4 ⇔ 3	10.75
1 ⇔ 2	9.5	3 ⇔ 2	9.5
2 ⇔ 3	10.75	2 ⇔ 1	8.25
3 ⇔ 4	12	1 ⇔ 0	7

Note : The thermostat is only authorised to increase by a stage if the following conditions are satisfied:

- ⇒ The condition on TEEG justifying the increase of THER continues for at least 3 minutes.
- ⇒ The chilled water output temperature TSEG is greater than the set point.
- ⇒ The number of compressors in service is equal to the thermostat value.

HOT THERMOSTAT

Function

To bring the temperature of the heated fluid as close as possible to the set point by adapting the number of compressors in service to the heat load in operation.

Description

The thermostat THER controls the switching on and off of compressors.

It is determined in accordance with the following parameters:

- TEEC ⇔ Hot water input temperature (°C)
 CONSREG ⇔ Active instruction for output of hot water (°C)
 The value of this instruction depends on the type of regulation required by the customer and the state of the logic input associated with the CHPCONS variable.

Option regulation with gradient	CHPCONS	Value of CONSREG
Not selected	0	CONSEA
	1	CONSEB
Selected (see page 16)	0	CONSEA
	1	CONSCALC = f(TEA)

- DELTAT ⇔ Desired temperature difference between water input and output (°C)
 ENCL ⇔ Operating differential for a regulation stage (°C)
 This variable is calculated as follows:

$$ENCL = (DELTAT / \text{No. Of compressors})$$

Example of a machine with 4 compressors:

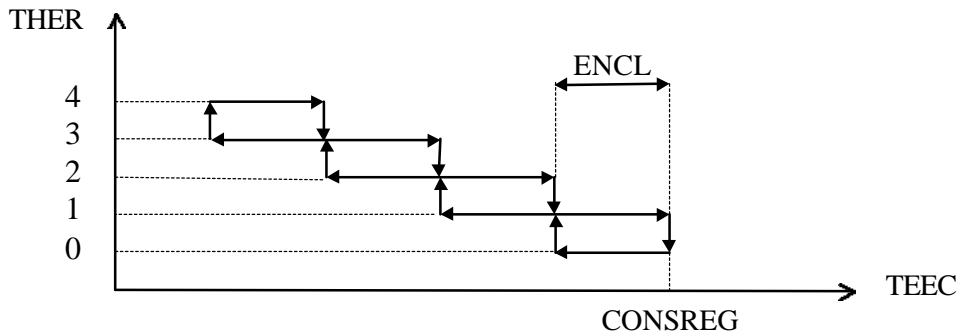

With CONSREG = 45°C
 and DELTAT = 5°C

⇒ ENCL = 1.25°C

Compressor start-up		Compressor stop	
THER	TEEC (°C)	THER	TEEC (°C)
0 ⇔ 1	43.75	4 ⇔ 3	41.25
1 ⇔ 2	42.5	3 ⇔ 2	42.5
2 ⇔ 3	41.25	2 ⇔ 1	43.75
3 ⇔ 4	40	1 ⇔ 0	45

Note : The thermostat is only authorised to increase by a stage if the following conditions are satisfied:

- ⇒ The condition on TEEC justifying the increase of THER continues for at least 3 minutes.
- ⇒ The hot water output temperature TSEC less than the set point.
- ⇒ The number of compressors in service is equal to the thermostat value.

CONTROL OF COMPRESSORS

Function

The compressors are started up and stopped in the order which avoids the anti-short cycle, as far as possible, and evens out their operating times..

Description

☞ Start-up and stopping order for compressors

This order is determined by a "FIFO" (first in, first out) rule. This function incorporates the automatic, instantaneous recording of a priority compressor which has become unavailable

☞ Compressor start-up and stopping

The compressor COMPmn starts up if all the following conditions are satisfied:

- ⇒ The water circulation pump received the order to operate at least 1 minute earlier.
- ⇒ The on / off switch for circuit n is ON (MAARn = 1).
- ⇒ The machine is available (DISPOM = 1).
- ⇒ Circuit n is available (DISPOCn = 1).
- ⇒ Compressor mn is available (DISPOmn = 1).
- ⇒ The regulation thermostat THER is greater than the number of compressors in service.
- ⇒ COMPmn is the compressor defined by the FIFO rule as the next one to start up.
- ⇒ The last start-up of COMPmn was at least 6 minutes earlier (ACCmn = 1).

The compressor COMPmn stops if at least one of the following conditions is satisfied:

- ⇒ The remote on / off switch for the machine is OFF (MAARD = 0).
- ⇒ The on / off switch for circuit n is OFF (MAARn = 0).
- ⇒ The machine is unavailable (DISPOM = 0).
- ⇒ Circuit n is unavailable (DISPOCn = 0).
- ⇒ Compressor mn is unavailable (DISPOmn = 0).
- ⇒ The regulation thermostat THER is less than the number of compressors in service and COMPmn is the compressor defined by the FIFO rule as the next one to be stopped.

		THER	0	1	2	3	4	3	4	3	2	1	2	3	2	3	4	3	2	1	0
Compressor number	Last one started up		-	1	2	3	4	-	1	-	-	-	2	3	-	4	1	-	-	-	-
	Last one stopped		-	-	-	-	-	1	-	2	3	4	-	-	1	-	-	2	3	4	1
	In operation		-	1	1 2	1 2 3	1 2 3 4	2 3 4	2 3 4 1	3 4 1	4 1	1	1 2	1 2 3	2 3	2 3 4	2 3 4 1	3 4 1	4 1	1	-

CONTROL OF CAPACITY REDUCTIONS FOR COLD REGULATION

Function

To adjust the chilled water output temperature as closely as possible to the set point, by adapting compressor capacity.

Description

Capacity reduction valves are only available on semi-hermetic reciprocating or screw compressors.

On a machine with several compressors, only the last one started up can modify its capacity. The other compressors are maintained at full capacity.

The number of capacity reductions to be put into operation is defined by the thermostat THERRP depending on the following 2 parameters:

- TSEG ⇔ Chilled water output temperature (°C)
- CONSREG ⇔ Chilled water instruction (°C)

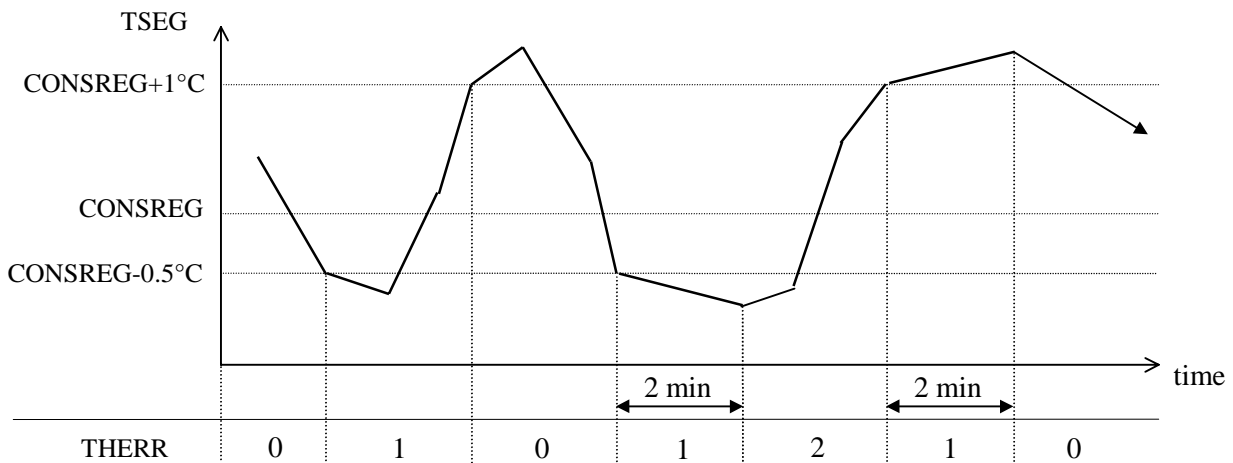

As soon as TSEG becomes lower than $CONSREG - 0.5^{\circ}C$, capacity is reduced

As long as the TSEG stays lower than $CONSREG - 0.5^{\circ}C$, an additional capacity reduction cuts in (if applicable) every 2 minutes.

If at least one capacity reduction is in service, one is stopped as soon as TSEG is greater than $CONSREG$.

As long as the TSEG condition is satisfied, an additional capacity reduction is stopped every 2 minutes.

If TSEG goes above $CONSREG + 1^{\circ}C$, all capacity reductions are stopped.

- Note:**
- The compressors are started up and maintained at reduced power for 2 minutes. The screw compressors start up at 25% of power.
 - In continuous regulation, the power reduction stages allowed on all screw compressors are 50 and 75%. The 25% stage is only used on machines with 2 compressors at the most.

CONTROL OF CAPACITY REDUCTIONS FOR HOT REGULATION

Function

To adjust the hot water output temperature as closely as possible to the set point by adapting compressor capacity.

Description

Capacity reduction valves are only available on semi-hermetic reciprocating or screw compressors.

On a machine with several compressors, only the last one started up can modify its capacity. The other compressors are maintained at full capacity.

The number of capacity reductions to be put into operation is defined by the thermostat THERR, in accordance with the following 2 parameters:

- TSEC ⇔ Hot water output temperature (°C)
- CONSREG ⇔ Chilled water instruction (°C)

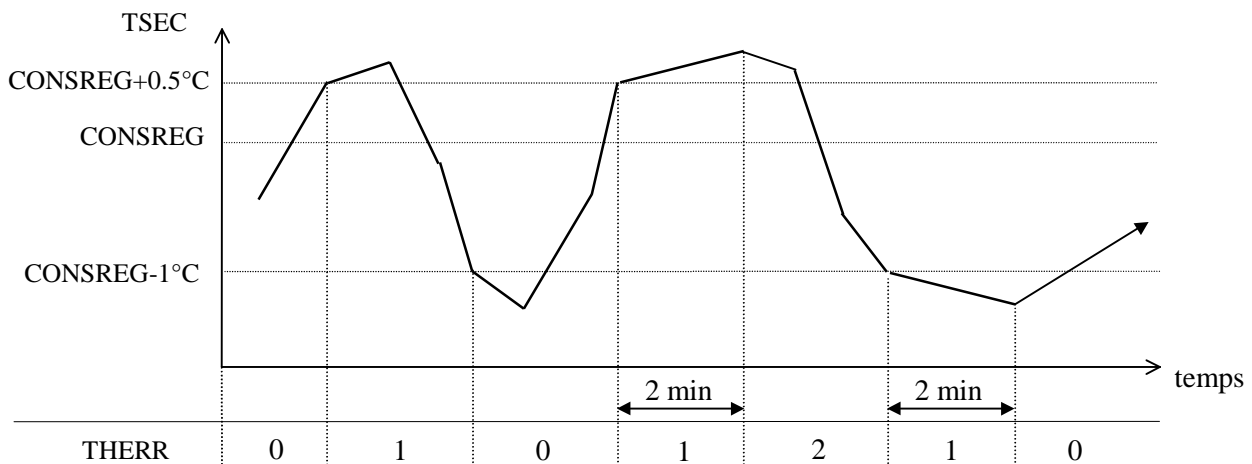

As soon as TSEC becomes greater than $CONSREG + 0.5^\circ C$, capacity is reduced. As long TSEC remains above $CONSREG + 0.5^\circ C$, an additional capacity reduction cuts in (if applicable) every 2 minutes.

If at least one capacity reduction is in service, one is stopped as soon as TSEC is less than $CONSREG - 1^\circ C$. As long as the TSEC condition is satisfied, an additional capacity reduction is stopped every 2 minutes.

- Note:**
- The compressors are started up and maintained at reduced power for 2 minutes. The screw compressors start up at 25% of power.
 - In continuous regulation, the power reduction stages allowed on all screw compressors are 50 and 75%. The 25% stage is only used on machines with 2 compressors at the most.

HP LOAD SHEDDING

Function

To reduce the power of a cooling circuit before the high pressure reaches the cut-off point.

Description

HP load shedding is only processed as standard on air condensation units which are not fitted with heat recovery. It is activated in particular at start-up of the machine, when the ambient air temperature is high.

The load shedding phase on circuit n is characterised by the variable DELESTn. It is determined in accordance with the condensation pressure on circuit n PTHPn.

☞ Activation of load shedding

As soon as high pressure PTHPn exceeds 25 bar absolute, circuit n is put into load shedding (DELESTn = 1).

On circuits with one compressor only, load shedding consists of forcing the compressor into maximum power reduction (on condition that the compressor is fitted with at least one power reduction valve). On circuits which have 2 compressors mounted in parallel, load shedding stops one of the 2 compressors.

☞ Stopping load shedding

When high pressure PTHPn goes back below 19 bar absolute, the load shedding phase of circuit n ends (DELESTn = 0). The circuit compressors go back to normal regulation which then only depends on thermostats THER and THERRP.

CONTROL OF ELECTRONIC EXPANSION VALVE

Function

To control correct filling of the evaporator with refrigerant in order to obtain highest efficiency, whilst protecting the compressor against slugging.

Description

The regulation described below is specific to electrical expansion valves with thermal motors, make Danfoss and type TQ.

The expansion valve is controlled by Proportional + Integral + Derivative logic. The ideal theoretical opening RDETA_n of the expansion valve on circuit n is determined and compared with the actual opening. Depending on the variation observed, an opening or closing order is issued to the expansion valve.

☞ Calculation of RDETA_n

The opening to be achieved RDETA_n depends on the following parameters:

- SURCHD ⇔ Superheat requested
The value of SURCHD is set to 5 °C for water regulation instructions greater than -5 °C and to 8 °C for water instructions less than -5 °C.
- TASP_n-TBP_n ⇔ Superheat measured on circuit n (°C)
- RDET_n ⇔ Opening measured on expansion valve (°C)

I.e. Δ and the difference at time t between the measured superheat and the instruction:

$$\Delta_{and} = (TASP_n - TBP_n) - SURCHD$$

$$REDTA_n = RDET_n - K_p \cdot \Delta_{and} + K_i \cdot \sum_{t-ni}^t \Delta e_t + K_d \cdot \sum_{t-nd}^t (\Delta e_t - \Delta e_{t-1})$$

Integral action
Derivative

Proportional action

☞ Order issued to expansion valve

There are 3 possible cases:

- ⇒ If RDETA_n < RDET_n, the expansion valve must be heated (DET_n=1) to open it to the desired opening.
- ⇒ If RDETA_n > RDET_n, the expansion valve is not heated (DET_n=0) so that it can close.
- ⇒ If RDETA_n = RDET_n, the expansion valve is maintained at its current opening value by alternating start and stop heating operations successively.

Note: Before start-up of the first compressor on the circuit, the expansion valve is pre-set to an opening value calculated on the basis of the chilled water output temperature.

CONTROL OF CONDENSER FANS

Function

To maintain as stable a condensation pressure as possible without fans cutting in too frequently.

Description

The CLIMATIC calculates the number of ventilation stages THVn required for the proper functioning of each refrigeration circuit.

THVn depends on the following parameters:

PTHPn ⇔ Condensation pressure in circuit n (abs. bar)

TEA ⇔ Outside air temperature (°C)

HPHAUT ⇔ High pressure limit (abs. bar)

HPBAS ⇔ Low pressure limit (abs. bar)

The minimum difference between HPHAUT and HPBAS is 5 bar.

TEMPOV ⇔ Timing of raising or lowering of ventilation stage (s)

Setting
instructions

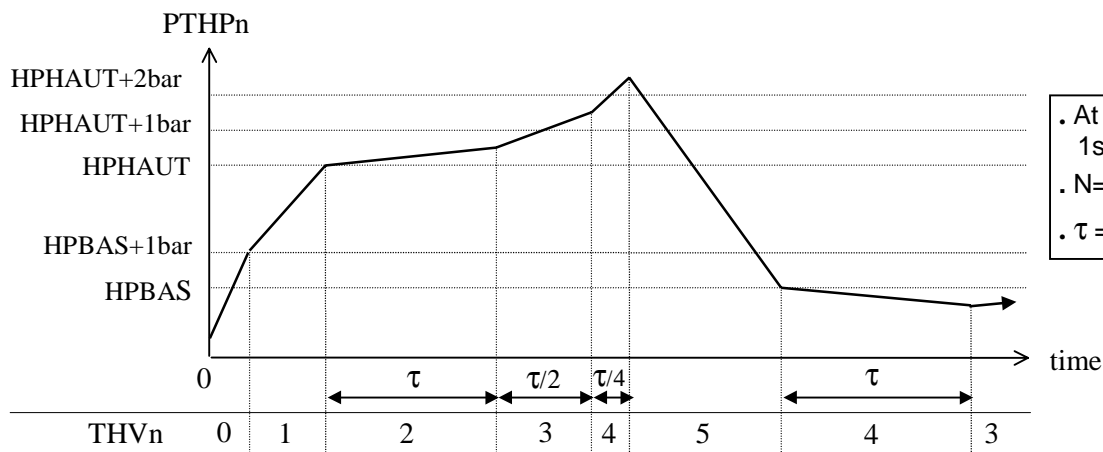

Fan operation

At the start-up of the first compressor on the circuit, as soon as high pressure becomes greater than $HPBAS+1bar$, N fans are immediately started up (the number N depends on the outside air temperature).

When $PTHPn$ exceeds $HPHAUT$, the thermostat is increased by one stage. If the pressure remains above $HPHAUT$, $THVn$ continues to be increased by one unit every T (time interval):

- . If $HPHAUT < PTHPn \leq HPHAUT+1bar$, $T = TEMPOV$
- . If $HPHAUT+1bar < PTHPn \leq HPHAUT+2bars$, $T = TEMPOV/2$
- . If $PTHPn > HPHAUT+2bars$, $T = TEMPOV/4$

Turning off fans

Once $PTHPn$ falls below $HPBAS$, $THVn$ is reduced by one stage. As long as $PTHPn$ remains below $HPBAS$, $THVn$ continues to be decreased by 1 every $TEMPOV$ (time interval).

Note: When stopping a ventilation stage relates to a 2-speed fan, switching from fast to slow speed is delayed by 5 seconds.

SPECIFIC VALVES FOR SCREW COMPRESSORS

Liquid injection valve using intermediate suction

Function

To reduce the compressor discharge temperature thereby improving cooling on the compressor motor.

Description

The liquid injection valve INJLmn is open if :

- . the compressor COMPmn is in operation
- and . the discharge temperature TREFmn is greater than 100°C

INJLmn is kept open as long as :

- . the compressor COMPmn is in operation
- and . the discharge temperature TREFmn is greater than 90°C.

Economy valve

Function

To increase refrigerating capacity by increased sub-cooling of the liquid refrigerant output from the condenser.

Description

The economy valve ECOmn is open if :

- . compressor COMPmn is in operation and at full capacity for 2 minutes
- and . the discharge temperature TREFmn is greater than θ
- and . high pressure in circuit n PTHPn is greater than P1.

ECOmn is kept open as long as:

- . compressor COMPmn is in operation and at full capacity
- and . the discharge temperature TREFmn is greater than $\theta - 2^\circ\text{C}$
- and . high pressure in circuit n PTHPn is greater than P2.

	θ (°C)	P1 (bar absolute)	P2 (bar absolute)
R22	65	11.9	11.2
R134a	40	7.7	6.7
R407C	45	13.5	11.7

OPTIONS

CONTENTS

	Page
COLD REGULATION WITH GRADIENT.....	15
HOT REGULATION WITH GRADIENT	16
LOW/HIGH SPEED CONTROL OF CONDENSER FANS.....	17
FREE-COOLING.....	19
HEAT RECOVERY	21
MANAGEMENT OF UNITS IN PARALLEL	22

COLD REGULATION WITH GRADIENT

Function

To adapt the regulation set point to the outside air temperature, for improved counterbalancing of solar heat pick-up by the premises to be air conditioned.

Description

The set point for CONSCALC regulation is calculated according to the following parameters:

- TEA ⇔ Outside air temperature (°C)
- CONSA ⇔ 1st reference air temperature selected (°C)
- CONSAM ⇔ 2nd reference air temperature selected (°C)
- TEGI ⇔ Minimum chilled water temperature instruction (°C)
- CONSEG ⇔ Required water instruction for air instruction CONSA (°C)
(CONSEG must be lower than +15°C).
- CONSEI ⇔ Required water instruction for air instruction CONSAM (°C)
(CONSEI must be greater than TEGI+2°C).
- PENTE F ⇔ Regulation gradient (%)
The gradient is calculated using the following equation:
$$PENTE F = 100 \times (CONSEI - CONSEG) / (CONSAM - CONSA)$$

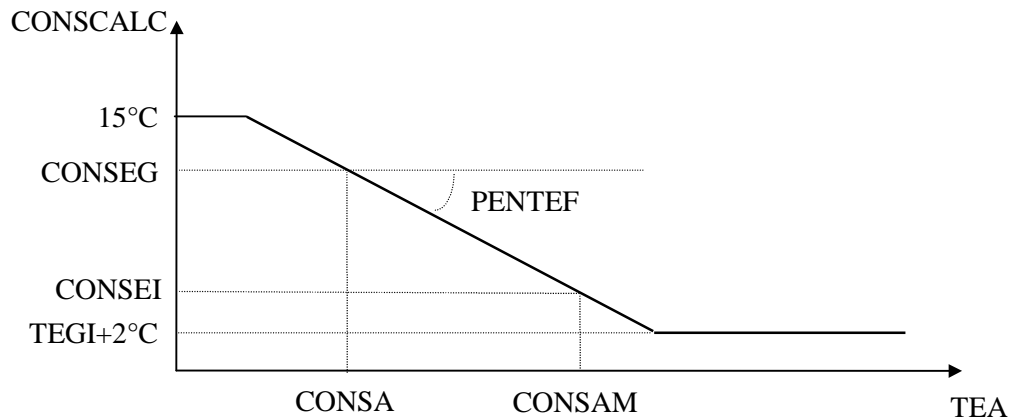

$$CONSCALC = CONSEG + PENTE F \times (TEA - CONSA) / 100$$

Example of regulation:

With CONSA = 20°C
 CONSEG = 10°C
 CONSAM = 35°C
 CONSEI = 6°C

⇒ PENTE F = -26.7 %

TEA (°C)	CONSCALC (°C)
20	10
25	8.66
30	7.33
35	6

HOT REGULATION WITH GRADIENT

Function

To adapt the regulation set point to the outside air temperature for improved counterbalancing of heat loss to the outside from the premises to be heated.

Description

The regulation set point CONSCALC is calculated according to the following parameters:

- TEA ⇔ Outside air temperature (°C)
- CONSAI ⇔ 1st reference air temperature selected (°C)
- CONSA ⇔ 2nd reference air temperature selected (°C)
- TECS ⇔ Maximum hot water temperature instruction (°C)
- CONSEM ⇔ Required water instruction for the air instruction CONSAI (°C)
(CONSEM must be less than TECS-2°C).
- CONSEC ⇔ Required water instruction for the air instruction CONSA (°C)
(CONSEC must be greater than 25°C).
- PENTEC ⇔ Regulation gradient (%)
The gradient is calculated using the following equation:
 $PENTEC = 100 \times ((CONSEC - CONSEM) / (CONSA - CONSAI))$

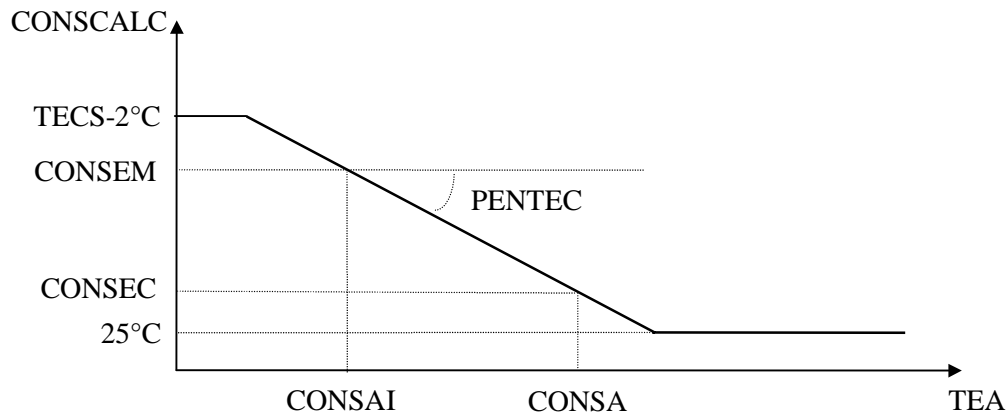

$$CONSCALC = CONSEC + (PENTEC \times (TEA - CONSA) / 100)$$

Example of regulation:

With CONSAI = -10°C
 CONSEM = 50°C
 CONSA = 15°C
 CONSEC = 30°C

⇒ PENTEC = -80 %

TEA (°C)	CONSCALC (°C)
-10	50
-5	46
0	42
5	38
10	34
15	30

LOW/HIGH SPEED CONTROL OF CONDENSER FANS

Function

To give priority to fan operation at low speed, only allowing switching to high speed to avoid HP cut-out.

Description

The CLIMATIC calculates the numbers of stages of low speed ventilation THVn and high speed THGVn required for correct operation of each cooling circuit.

THVn and THGVn depend on the following parameters:

- PTHPn ⇔ Condensation pressure circuit n (bar abs.)
- TEA ⇔ Outside air temperature (°C)
- HPHAUT ⇔ High pressure limit for start-up of fans (bar abs.)
- HPBAS ⇔ Low pressure limit for stopping fans (bar abs.)
The difference between HPHAUT and HPBAS must be 5 bar minimum.
- HPGV ⇔ High pressure limit for switching fans to high speed (bar abs.)
The difference between HPGV and HPHAUT must be at least 3 bar.
- HPDIFF ⇔ Pressure differential for switching of fans to low speed (bar)
The minimum value of HPDIFF is 2 bar.
- TEMPOV ⇔ Timing for increasing or reducing ventilation stage(s)
- MAARGV ⇔ Confirmation of high speed mode
This variable is associated with a logic input allowing the user, via a hard contact, to authorise or prevent switching of fans to high speed.

Instructions
can be
adjusted

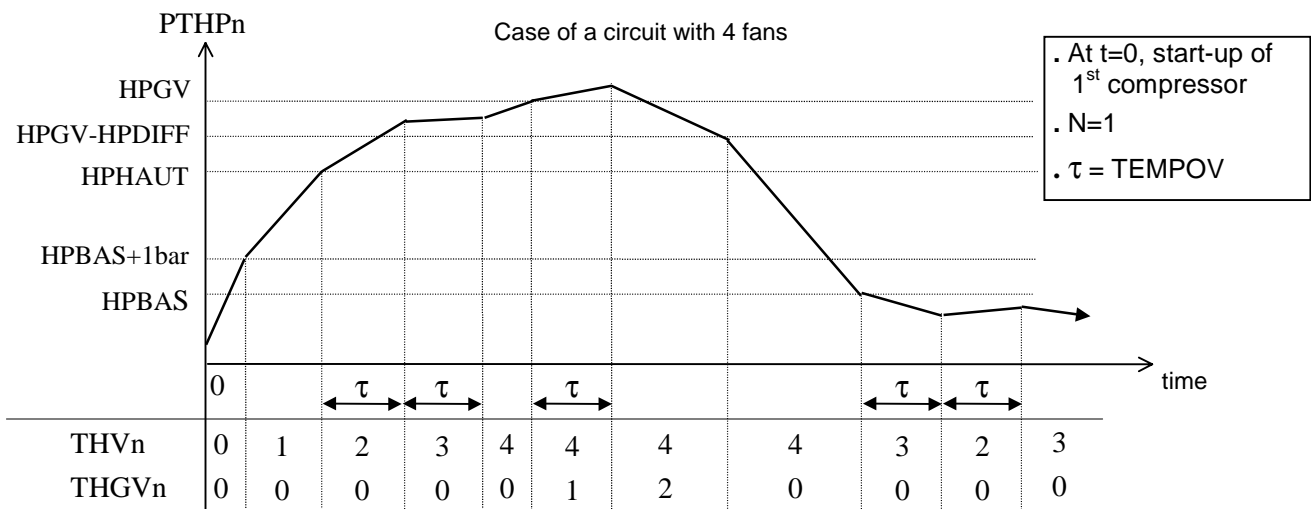

Putting fans into service at low speed

At start-up of the first compressor on the circuit, as soon as high pressure is greater than HPBAS+1bar, N fans are started immediately (the number N depends on the outside air temperature).

When PTHPn exceeds HPHAUT, the thermostat THVn is increased by a stage. When the pressure remains above HPHAUT, THVn continues to be incremented by one unit every TEMPOV (time interval).

LOW / HIGH SPEED CONTROL OF CONDENSER FANS (suite)

☞ Switching fans to high speed

Switching of one or more fans to high speed is only authorised if the variable MAARGV is set to 1.

When all fans on the circuit are running at low speed (THVn = total number of fans on the circuit) and PTHPn exceeds HPGV, a fan is switched from low to high speed: the thermostat THGVn is increased by one stage. As long as the pressure remains above HPGV, THGVn continues to be incremented by one unit every TEMPOV (time interval).

When a fan is switched to high speed, it is included in THGVn and also continues to be counted in thermostat THVn.

☞ Return of fans to low speed

As soon as PTHPn goes back below HPGV-HPDIFF, all fans running at high speed are switched back to low speed.

☞ Stopping fans

If PTHPn becomes lower than HPBAS, THVn is reduced by one stage. As long as PTHPn remains below HPBAS, THVn continues to be reduced by 1 every TEMPOV (time interval).

- Notes:**
- In Low speed/high speed mode, all fans on the machine must be dual speed.
 - In certain cases (in particular on machines with 4 cooling circuits), the lack of available relay outputs on the CLIMATIC means that we have had to modify the regulation described above: as soon as high pressure exceeds Hphigh speed, fans on the same circuit are all switched to high speed at the same time, instead of one after another.

FREE-COOLING

Function

To ensure refrigeration whilst optimising the use of free-cooling, thus limiting electrical consumption to a minimum.

Description

☛ Free-cooling outline diagram

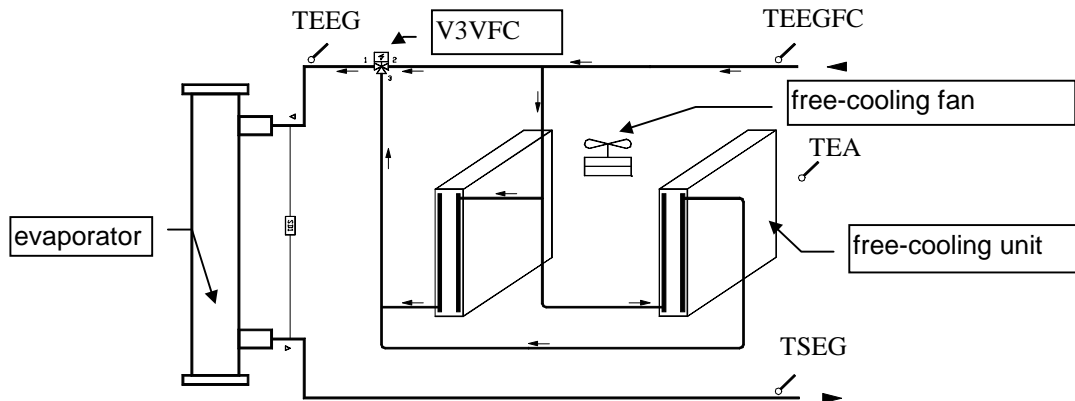

- TEEGFC ⇔ Temperature of chilled water input to free-cooling (°C)
- TEEG ⇔ Temperature of chilled water input to the evaporator (°C)
- TSEG ⇔ Chilled water output temperature (°C)
- TEA ⇔ Outside air temperature (°C)
- V3VFC ⇔ Three-way free-cooling valve

☛ Control of the three-way free-cooling valve:

V3VFC is fed if all the following conditions are satisfied:

- ⇒ TEEGFC is greater than the regulation instruction CONSREG.
- ⇒ $TEA < TEEGFC - 2^{\circ}\text{C}$.
- ⇒ The chilled water circulation pump has been in operation for at least 30 seconds.
- ⇒ The three way valve has remained off for 3 minutes.
- ⇒ The free-cooling water input sensor is not defective.

V3VFC is kept connected as long as all following conditions are satisfied:

- ⇒ TEEGFC is not less than CONSREG.
- ⇒ $TEA < TEEGFC$.
- ⇒ The pump is in operation.
- ⇒ The free-cooling water input sensor is not defective.

☛ Control of free-cooling fans

The number of ventilation stages required for the batteries is determined by the free-cooling thermostat THERFC. This parameter depends on the temperature of the water input to the evaporator TEEG and on the regulation instruction.

FREE-COOLING (CONT'D)

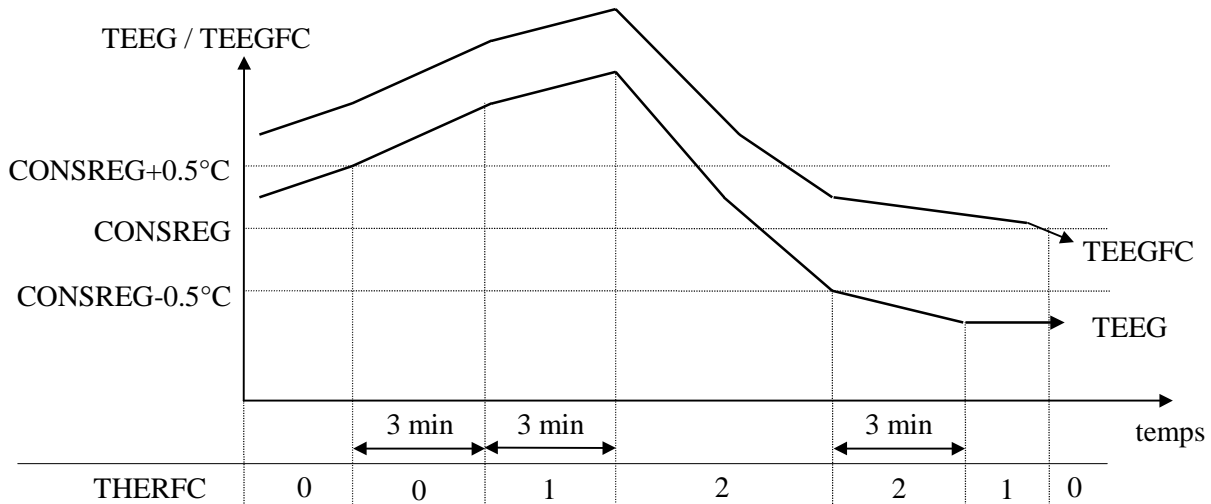

The thermostat is incremented by one stage if TEEG remains greater than $\text{CONSREG}+0.5^{\circ}\text{C}$ for over 3 minutes. As long as this condition on TEEG is satisfied, THERFC continues to be incremented by one stage every 3 minutes.

If TEEG remains lower than $(\text{CONSREG}-0.5^{\circ}\text{C})$ the free-cooling thermostat is reduced by one stage every 3 minutes.

When TEEGFC falls below the set point, all ventilation stages are halted.

If the compressor regulation thermostat THER requires at least one stage of regulation whilst free-cooling is in service, the free-cooling thermostat is forced to its maximum.

The free-cooling fan n VENTFCn operates if :

- . $\text{THERFC} \geq n$
- and . V3VFC is in service.

☞ Authorisation of compressor start-up

Authorisation of compressor start-up, in parallel with free-cooling operation, is defined by the variable AUTOCP which is dependent on the following parameters:

- V3VFC ⇔ Three-way free-cooling valve
- THERFC ⇔ Free-cooling regulation thermostat
- THER ⇔ Compressor regulation thermostat

AUTOCP is set to 1 if:

- . THERFC is at its maximum and TEEG is greater than CONSREG for over 3 minutes
- or . V3VFC is not fed.

AUTOCP is kept at 1 as long as :

- . THER is strictly positive
- or . V3VFC is not fed.

HEAT RECOVERY

Function

On air units with heat recovery condenser, to maintain the hot water output temperature as close as possible to the instruction, whilst adapting the air condenser capacity to the excess thermal capacity to be discharged.

Description

☞ Outline diagram of heat recovery process

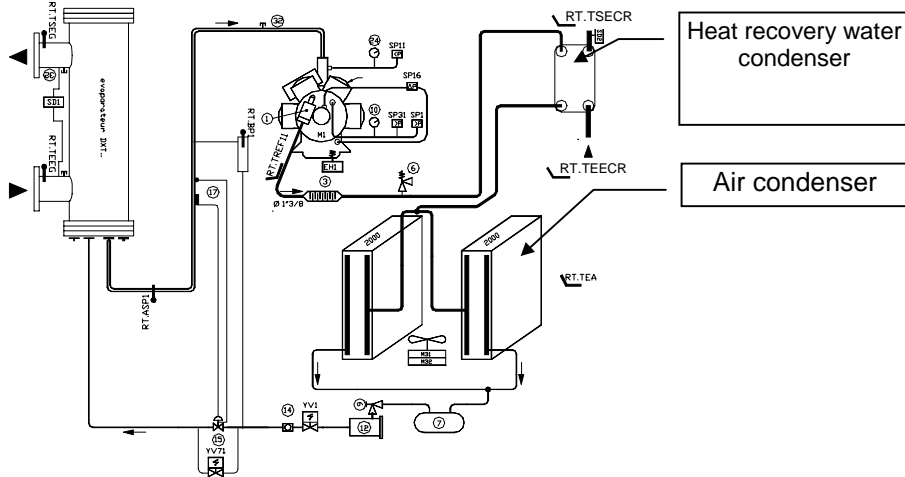

☞ Determination of heat recovery mode

Unit operation in heat recovery or total discharge mode is defined by the RECUP parameter which is set to 1 or 0. RECUP is determined depending on:

- FSCR ⇔ Recovery condenser flow controller
- TSECR ⇔ Hot water output temperature (°C)
- CONSECR ⇔ Hot water instruction (°C)

RECUP is set to 1 if:

- . FSCR is on for over 15 seconds
- and . TSECR < CONSECR.

RECUP remains at 1 as long as:

- . FSCR has not been off for over 15 seconds
- and . TSECR < CONSECR + 2°C.

☞ Control of air condenser fans

On switching to recovery mode, the ventilation thermostat for circuit n THVn is forced to 0 for 5 seconds.

If the high pressure of circuit n exceeds 25 bar, THVn is increased by 1 stage. The ventilation thermostat continues to be incremented by 1 every TEMPOV (time interval) as long as the condition on the pressure is satisfied. Every time THVn is incremented, the value of the hot water output temperature TSECR is memorised in the variable MTSECR.

In recovery mode, if TSECR becomes lower than MTSECR whilst at least one fan is in operation, the ventilation thermostat is decremented.

Note: On water units, the CLIMATIC does not include heat recovery

MANAGEMENT OF UNITS IN PARALLEL

Function

To ensure, via an independent CPU card, staging of several units installed on the same water loop, in order to adjust the temperature of the cooled fluid as closely as possible to the set point.

Description

General regulation is by a KP01 independent of those which directly control the units. Dialogue between the cards is by hard contact only, without chaining.

☞ Outline hydraulics diagram (case of chilled water production)

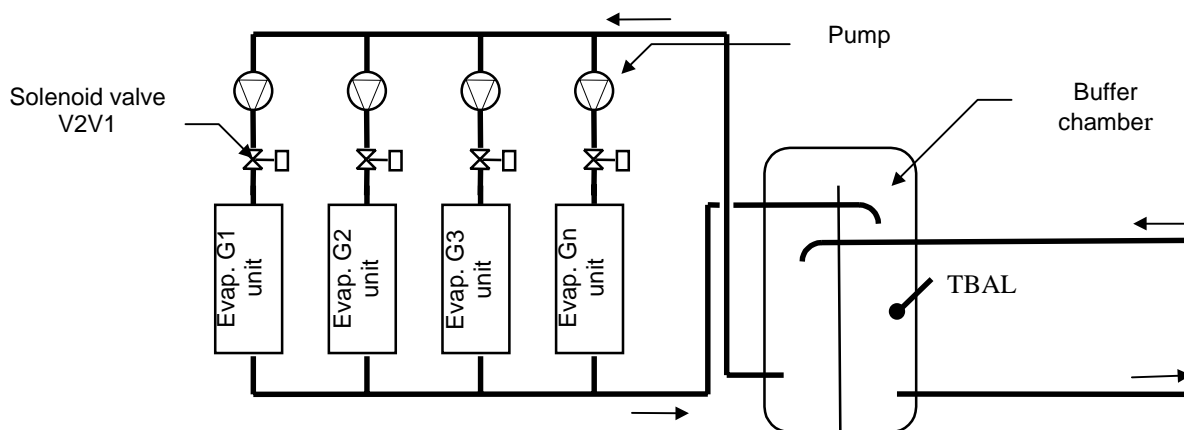

☞ Thermostat on units

The thermostat THERG controls switching on and off of the different installation units Gn.

THERG is calculated in accordance with the following parameters:

- TBAL ⇔ Water temperature in the chamber (°C)
- CONSEG ⇔ Water instruction for general regulation (°C)
- ENCLG ⇔ Operating differential for one unit (°C)
- DIFETG ⇔ Differential between units (°C)

Case of an installation with 4 machines:

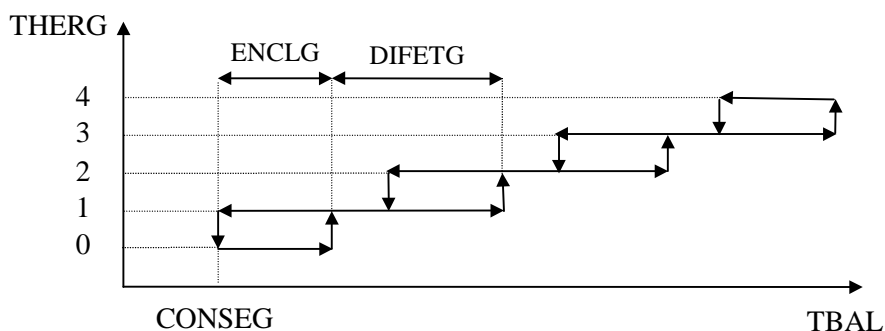

MANAGEMENT OF UNITS IN PARALLEL

With CONSEG = 6°C
 ENCLG = 1.5°C
 DIFETG = 1.5°C

Units start-up		Unit stop	
THERG	TBAL (°C)	THERG	TBAL (°C)
0 ⇨ 1	7.5	1 ⇨ 0	6
1 ⇨ 2	9	2 ⇨ 1	7.5
2 ⇨ 3	10.5	3 ⇨ 2	9
3 ⇨ 4	12	4 ⇨ 3	10.5

Notes: THERG can only be incremented by a stage if it has not increased for a time defined using instructions TPHERM.
 THERG can only be decremented by a stage if it has not decreased for a time defined using instructions TPHERD.

☞ Control of isolation valves for evaporators on each unit

If the regulation thermostat THERG requests operation of unit Gn, valve V2Vn is sent a command to open.

☞ Operation of units

The start-up of the next priority unit Gn is authorised if the opening command has been issued to valve V2Vn for at least TPV2V (variable time). The hard contact representing this authorisation to switch a unit on (associated variable MAARGn) must be wired to the "remote on / off" input connection for the machine.

Each unit controls its own compressors and pump in accordance with its own set point (see "cold thermostat" chapter page 5). For better general regulation, it is recommended to set unit instructions to the same value as CONSEG.

☞ Fault management and automatic unit logging

Each unit sends its availability state to the general regulation card. Depending on the overall availability of all units, an optimal priority order PRIG is defined (units with no faults are put at the top of the priority list):

PRIG	Ordure of unit start-up
0	G1 / G2 / G3 / G4
1	G4 / G1 / G2 / G3
2	G3 / G4 / G1 / G2
3	G2 / G3 / G4 / G1

In order to level out operating times for the different units, and if they are all available, PRIG changes automatically once a week, on Monday at 6 pm.

If the temperature sensor in the chamber is defective, all the valves are opened and, when the time interval TPV2V is up, start-up authorisation is issued to all the units.

MACHINE FAULTS

CONTENTS

	Page
TEMPERATURES OF CHILLED WATER OUTSIDE RANGE	25
HOT WATER TEMPERATURES OUTSIDE RANGE	26
INSUFFICIENT FLOW OF CHILLED WATER	27
INSUFFICIENT FLOW OF HOT WATER	28
ABSENCE OF 230V SUPPLY WITH BACKUP	29
INCORRECT SEQUENCE OF PHASES.....	30

TEMPERATURES OF CHILLED WATER OUTSIDE RANGE

Logical variable: **DTEG**

Incident codes KP02: **1**

KP07 icon:



Description

The input or output chilled water temperature measured by the sensor is outside the authorised range:

Water without glycol

TEEG < TEGI or TEEG > 65°C

TSEG < TEGI or TSEG > 65°C

Water with glycol (maxi 30% glycol)

TEEG < -15°C or TEEG > 65°C

TSEG < -15°C or TSEG > 65°C

With:

TEEG ⇔ Chilled water input temperature (°C)

TSEG ⇔ Chilled water output temperature (°C)

TEGI ⇔ Minimum chilled water temperature for evaporator (°C)

Action

- ☞ Immediate machine halt.
- ☞ The fault is displayed on the screen.
- ☞ The remote fault report is delayed for 6 minutes.

Resetting

Automatic fault resetting once chilled water temperatures return to normal operating range:

Water without glycol

TEGI+2°C < TEEG < 60°C

TEGI+2°C < TSEG < 60°C

Water with glycol (maxi 30% glycol)

-13°C < TEEG < 60°C

-13°C < TSEG < 60°C

Trouble-shooting

Sensor fault on input or output of chilled water.
Wiring fault or disconnection of sensor.

Solution

Replace sensor.
Check sensor connection.

HOT WATER TEMPERATURES OUTSIDE RANGE

Logical variable: **DTEC**

Incident codes KP02: **2**

KP07 icon: 

Description

The input or output temperature of hot water measured on the water cooled condensers is outside the authorised range:

TEEC <-27°C or TEEC> TECS

TSEC <-27°C or TSEC> TECS

With:

TEEC ⇔ Hot water input temperature (°C)

TSEC ⇔ Hot water output temperature (°C)

TECS ⇔ Maximum hot water temperature at condenser (°C)

Action

- ☞ Immediate machine halt.
- ☞ The fault is displayed on the screen.
- ☞ The remote fault report is delayed for 6 minutes.

Resetting

Automatic fault resetting once hot water temperatures return to normal operating range:

TEEC > -27°C and TEEC < TECS-5°C

TSEC > -27°C and TSEC < TECS-5°C

Trouble-shooting

Hot water input or output sensor defective.
Wiring fault or disconnection of the sensor.

Solution

Replace the sensor.
Check sensor connection.

INSUFFICIENT FLOW OF CHILLED WATER

Logical variable: **DFSE**

Incident codes KP02: **3**

KP07 icon:



Description

The "flow switch" FSE detects an insufficient flow in the evaporator for over 2 seconds.

Action

- ☞ Immediate machine halt.
- ☞ The fault is displayed on the screen.
- ☞ The remote fault report is delayed for 6 minutes

Resetting

The machine restarts **automatically** 20 seconds after the flow of chilled water is restored.

Trouble-shooting

Wiring fault on pump control.
Wiring fault on flow controller.
Water filter clogged.
Setting fault on flow controller.

Solution

Check pump connection.
Check flow controller connection.
Clean water filter.
Adjust flow controller.

INSUFFICIENT FLOW OF HOT WATER

Logical variable: **DFSC**

Incident codes KP02: **4**

KP07 icon:



Description

The "flow switch" FSC detects insufficient flow insufficient in the condenser for over 3 seconds

Action

- ☞ Immediate machine halt.
- ☞ The fault is displayed on the screen.
- ☞ The remote fault report is delayed for 6 minutes.

Resetting

The machine restarts **automatically** 20 seconds after the flow of hot water is restored.

Trouble-shooting

Wiring fault on control pump.
Wiring fault on flow controller.
Water filter clogged.
Setting fault on flow controller.

Solution

Check pump connection.
Check flow controller connection.
Clean water filter.
Adjust flow controller.

ABSENCE OF 230V SUPPLY WITH BACKUP

Logical variable: **DPT230V**

Incident codes KP02: **7**

KP07 icon:



Description

The supply presence voltage relay is tripped (PT230V = 0).
The compressor casing resistors and the anti-freeze resistors on the hydraulic circuit are no longer fed.

Action

- ☞ Immediate machine halt.
- ☞ The fault is displayed on the screen.
- ☞ The remote fault report is delayed for 6 minutes.

Resetting

The machine restarts **automatically** 20 seconds after the 230 V supply has been restored.

Trouble-shooting

Wiring fault on 230 V supply.
Wiring fault on voltage presence relay.

Solution

Check connections and voltage of 230 V power supply arriving at the machine.
Check wiring of power presence relay.

INCORRECT SEQUENCE OF PHASES

Logical variable: **DPHASE**

Incident codes KP02: **9**

KP07 icon:



Description

This fault only applies to machines fitted with scroll or screw compressors.

The phase controller is tripped (PHASE = 0).
It detects an inversion or a bad phase coupling.

Action

- ☞ Immediate machine halt.
- ☞ The fault is displayed on the screen.
- ☞ The remote fault report is delayed for 6 minutes.

Resetting

The machine can only be restarted after **manual** resetting and the correct re-establishment of phases.

Note: The fault is cleared **automatically** every time the machine is switched on.

Trouble-shooting

Fault appears the first time the machine is switched on.
Absence of a supply phase.

Wiring fault on phase presence contact.

Solution

Reverse two of the three phases upstream of the unit.
Check the presence of the three phases and voltage values between phases.
Check wiring on phase presence contact.

CIRCUITS FAULTS

CONTENTS

	Page
LOW PRESSURE INSUFFICIENT.....	32
EVAPORATOR FREEZING	33
INSUFFICIENT SUPERHEATING	34
VACUUM SUCTION FAILURE	35
SENSOR OR DETECTOR FAULTS	36
EXPANSION VALVE OPENING INCORRECT	37

LOW PRESSURE INSUFFICIENT

Logical variable: **DBPn**

Incident codes KP02: **n1**

KP07 icon:



Description

The BP cut-off point is defined as a refrigerant function as follows:

R22 ⇒ 2 bar abs. (or -25°C at saturation temperature)

R407C ⇒ 1.5 bar abs. (or -28°C at steam saturation temperature).

Case ①: No compressor on circuit n is working. The liquid valve has been open for 2 minutes, but low pressure remains lower than safety limits.

Note: On screw units, the liquid valve is controlled in parallel with the compressor. The condition on its opening has therefore not been taken into account when generating the BP fault.

Case ②: A compressor on circuit n has been operating for more than 2 minutes. The liquid valve is open and the expansion valve bypass valve (if applicable) has been closed for 1 minute, but low pressure is insufficient.

Reminder: The units with an expansion valve bypass valve are those fitted with the "all seasons" option and thermostatic expansion valves.

Case ③: A compressor on circuit n has been operating for over 6 minutes, all other compressors in service on the circuit have been operating for at least 2 minutes and insufficient low pressure is detected

Action

- ☞ If circuit n is not in operation, start-up has not been authorised. If it is in operation, it stops immediately.
- ☞ The fault is displayed on the screen.
- ☞ The remote fault report is delayed for 6 minutes.

Resetting

The fault reset limits are as follows:

R22 ⇒ 3 bar abs. (or -14°C at saturation temperature)

R407C ⇒ 2.5 bar abs. (or -16°C at steam saturation temperature).

Case ① & ②: **Three automatic fault resets are allowed daily. After this, circuit n can only be restarted after manual resetting.**

Case ③: Resetting is *manual*.

Note: "Low pressure" failure counters TOBPn are all *reset to zero daily at 6 pm*, on condition that the maximum number of faults authorised has not been reached.

Trouble-shooting

Insufficient circuit load.
Malfunction of the liquid solenoid valve.
Malfunction of expansion valve.
Dehydrator clogged.

Solution

Complete the load.
Check solenoid valve operation.
Check expansion valve operation.
Change dehydrator.

EVAPORATOR FREEZING

Logical variable: **DGELn**

Incident codes KP02: **n2**

KP07 icon:



Description

This fault is only processed on machines cooling water without solution which does not freeze at 0°C (glycol or brine)

Case ①: Tubular exchangers

A compressor m on circuit n has been operating for at least 1 minute and the following 2 conditions remain satisfied for over 2 minutes:
 TBPn < TBPI and TASPn < +5°C

Case ②: Plate exchangers

A compressor m on circuit n has been operating for at least 2 minutes and:
 TBPn < TBPI for over
 . **5 seconds** for R407C units
 . **30 seconds** for R22 units.

With: TBPn ⇔ Evaporation temperature circuit n (°C)

TASPn ⇔ Suction temperature for circuit n (°C)

TBPI ⇔ Minimum evaporation temperature (°C)

The minimum (and default) value of instruction TBPI is defined as follows:

Exchanger type	R407C	R22
Tubular (case ①)	-1°C (suction temp (superheated))	-4°C
Plate (case ②)	+1°C (suction temp (superheated))	-1,7°C

Action

- ☞ Immediate halt of circuit n.
- ☞ The fault is displayed on the screen.
- ☞ The remote fault report is delayed for 6 minutes.

Resetting

Case ①: For the first fault, resetting is **automatic** after of **30 minutes**, if the evaporation temperature has returned to over TBPI + 5°C.
 After this, circuit n can only be restarted after **manual** resetting

Case ②: For the first fault, the resetting is **automatic** after **30 minutes**, if the evaporation temperature has returned to over TBPI + 3°C.
 After this, circuit n can only be restarted after **manual** resetting.

Note: "Freeze" failure counters TOGELn are all reset to **zero daily at 6 pm**, on condition that the maximum number of authorised faults has not been reached.

Trouble-shooting

Incorrect TBPI instruction settings.
 Evaporation, or suction sensor fault.
 Wiring fault or disconnection of the sensor.
 Water flow in the evaporator insufficient.

Solution

Check instruction settings.
 Replace the sensor.
 Check sensor connection.
 Check flow and setting of flow controller.

INSUFFICIENT SUPERHEATING

Logical variable: **DSURFn**

Incident codes KP02: **n4**

KP07 icon:



Description

This fault is only processed on units fitted with electrical expansion valves.

A compressor on circuit n has been operating for at least 2 minutes and one of the 2 following conditions remains satisfied for at least 2 *minutes* :

$$TASPn \geq (TEEG + 3^{\circ}\text{C})$$

$$(TASPn - TBPn) \leq 2^{\circ}\text{C}$$

With :

TASPn ⇔ Suction temperature on circuit n (°C)

TBPn ⇔ Evaporation temperature on circuit n (°C)

TEEG ⇔ Chilled water intake temperature (°C)

Action

- ☞ Immediate halt of circuit n.
- ☞ The fault is displayed on the screen.
- ☞ The remote fault report is delayed for 6 minutes.

Resetting

Fault resetting is **manual**.

Trouble-shooting

Evaporation, suction or chilled water intake sensor fault.
Wiring fault or disconnection of one of these sensors.

Solution

Replace the sensor.
Check sensor connections.

VACUUM SUCTION FAILURE

Logical variable: **DPUMPDn**

Incident codes KP02: **n5**

KP07 icon:



Description

This fault is only processed on units in which the evaporator is physically located above the compressors (e. g. LCW range).

For **2 minutes**, a compressor on circuit n is in operation and the liquid solenoid is not connected, but low pressure is still below minimum.

The end limit of vacuum creation is defined as a refrigerant function, as follows:

R22 ⇒ 2 bar abs. (or -25 °C at saturation temperature)

R407C ⇒ 3 bar abs. (or -11 °C at vapour saturation temperature).

Action

- ☞ Immediate halt of circuit n.
- ☞ The fault is displayed on the screen.
- ☞ The remote fault report is delayed for 6 minutes.

Resetting

The first 2 faults are **automatically** reset after **2 minutes**.

After this, circuit n can only be restarted after a **manual** reset.

Note : Counters of “pump down” failures TOPUMPDn are all *reset to zero daily at 6 pm*, on condition that the maximum number of authorised faults has not been reached.

Trouble-shooting

Liquid solenoid blocked open by foreign matter.

Solution

Change the solenoid valve.

SENSOR OR DETECTOR FAULTS

Logical variable: **DSONDEn**

Incident codes KP02: **n6**

KP07 icon:



Description

One or more temperature sensors or pressure detectors installed on circuit n are either in short-circuit, broken or disconnected.

Sensor or detector involved

Suction temperature sensor
 Internal sensor on electronic expansion
 Low pressure detector
 High pressure detector

Condition for occurrence of fault

$TASp_n \leq -40^\circ\text{C}$
 $1000 U \leq RDET_n \leq 50 U$
 $BP_n \leq 0.5 \text{ bar}$
 $HP_n \leq 0.5 \text{ bar}$

Note : All these sensors and detectors are not necessarily present on the same machine.

Action

- ☞ Immediate halt of circuit n.
- ☞ The fault is displayed on the screen.
- ☞ The remote fault report is delayed for 6 minutes.

Resetting

Circuit n can only be restarted after **manual** resetting and correct reading of all detectors and sensors.

Trouble-shooting

Sensor or detector fault.
 Wiring fault or disconnection of a sensor or detector.

Solution

Replace the element.
 Check sensor and detector connections

EXPANSION VALVE OPENING INCORRECT

Logical variable: **DCDEtn**

Incident codes KP02: **n7**

KP07 icon:



Description

This fault is only processed on units equipped with electric expansion valves DANFOSS TQ type.

No compressor on circuit n is working. A compressor start-up command has been issued and the expansion valve is in the pre-heat phase.

After **6 minutes**, the expansion valve opening value calculated for start-up of the compressor has still not been reached.

Action

- ☞ Circuit n start-up is not authorised.
- ☞ The fault is displayed on the screen.
- ☞ The remote fault report is delayed for 6 minutes.

Resetting

Fault resetting is **manual**.

Trouble-shooting

Expansion valve sensor fault.
Wiring fault or disconnection of the sensor.
24V supply fault on expansion valve.
The green LED on the static relay is lit up but the expansion valve is not heating.

Solution

Replace expansion valve.
Check sensor connection.
Check supply
Check the static relay and the expansion valve controller card.

COMPRESSOR FAULTS

CONTENTS

	Page
COMPRESSOR CUT-OUT SWITCH TRIPPED	39
OIL PRESSURE INSUFFICIENT	40
EXCESS HIGH PRESSURE	41
DISCHARGE TEMPERATURE TOO HIGH	42
INTERNAL PROTECTION TRIPPED.....	43

COMPRESSOR CUT-OUT SWITCH TRIPPED

Logical variable: **DELECMn**

Incident codes KP02: **mn1**

KP07 icon: 

Description

The thermomagnetic cut-out switch on compressor mn is tripped (ELECmn = 0).

Action

- ☞ Immediate halt of compressor mn.
- ☞ The fault is displayed on the screen.
- ☞ The remote fault report is delayed for 6 minutes.

Resetting

Compressor mn can only be restarted after engagement of the cut-out switch and a **manual** reset.

Note: The fault is cleared **automatically** every time the machine is switched on.

Trouble-shooting

Faulty connection or connections too tight.
Cut-out switch wrongly set.

Solution

Check connections.
Set the protection in accordance with the rated current for the compressor.

OIL PRESSURE INSUFFICIENT

Logical variable: **DHUILEmn**

Incident codes KP02: **mn2**

KP07 icon:



Description

This fault only applies to semi-hermetic reciprocating compressors.

The total time during which the oil pressostat on compressor mn POILmn remains tripped exceeds *90 seconds*. The oil pressure is then insufficient for proper lubrication of the compressor.

Note: The counter for periods of low oil pressure is reset to zero if the oil pressostat remains above its triggering point for over 3 minutes.

Action

- ☞ Immediate halt of compressor mn.
- ☞ The fault is displayed on the screen.
- ☞ The remote fault report is delayed for 6 minutes.

Resetting

The first fault is cleared **automatically**.

After this, compressor mn can only be restarted after a **manual** reset

Note : Counters for "oil pressure" failures TOOILmn are all **reset to zero daily at 6 pm**, on condition that the maximum number of authorised faults has not been reached.

Trouble-shooting

Lack of oil in the compressor.
Oil pump fault.
Oil pressostat wrongly set.
Wiring fault on oil pressostat.

Solution

Check oil level.
Change oil pump.
Check setting of oil pressostat.
Check wiring on oil pressostat.

EXCESS HIGH TEMPERATURE

Logical variable: **DHPmn**

Incident codes KP02: **mn5**

KP07 icon:



Description

The high pressure safety cut-out on compressor mn PHPmn has tripped..

Action

- ☞ Immediate halt of compressor mn.
- ☞ The fault is displayed on the screen.
- ☞ The remote fault report is delayed for 6 minutes.

Resetting

The first 2 faults are reset **automatically**

After this, the compressor mn can only be started after a **manual** reset.

Note : Counters for " high pressure" failures TOHPmn are all **reset to zero daily at 6 pm**, on condition that the maximum number of authorised faults has not been reached.

Trouble-shooting

Condenser clogged.
 Fault on parameter settings for regulation of condensation.
 Malfunction of liquid solenoid valve.
 Dehydrator clogged.
 Wiring fault or high pressure safety cut-out wrongly set

Solution

Clean condenser
 Check parameter settings

 Check operation of solenoid valve.
 Replace the dehydrator
 Check setting and wiring of high pressure safety cut-out.

DISCHARGE TEMPERATURE TOO HIGH

Logical variable: **DREFmn**

Incident codes KP02: **mn6**

KP07 icon:



Description

The discharge temperature on compressor mn REFmn stays over **120°C** for over **9 seconds**.

Action

- ☞ Immediate halt of compressor mn.
- ☞ The fault is displayed on the screen.
- ☞ The remote fault report is delayed for 6 minutes

Resetting

The first 2 faults are reset **automatically** after a delay of **30 minutes** on condition that REFmn has dropped below 90°C.

After this, compressor mn can only be restarted by **manual** resetting (this reset can only be processed **30 minutes** after generation of the fault).

Note : Counters for “discharge too high” failures TOREFmn **are all reset to zero daily at 6 pm**, on condition that the maximum number of authorised faults has not been reached.

Trouble-shooting

Discharge sensor fault.
Wiring fault on the sensor.
Insufficient refrigerant in circuit.
Superheat setting too high.

Solution

Replace sensor.
Check sensor connection.
Check refrigerant.
Check superheat setting.

INTERNAL PROTECTION TRIPPED

Logical variable: **DPINTmn**

Incident codes KP02: **mn7**

KP07 icon: 

Description

☞ Semi-hermetic compressors (reciprocating and screw type) and scroll compressors :

The thermal protection on the motor windings on mn PINTmn is tripped.

☞ Hermetic reciprocating compressors :

Compressor mn has been operating for 6 minutes and the discharge temperature REFmn is less than θ . This shows that the internal protection on the compressor has been tripped.

	θ (°C)
R22 & R407C	40
R134a & R404A	30

Action

- ☞ Immediate halt of compressor mn.
- ☞ The fault is displayed on the screen.
- ☞ The remote fault report is delayed for 6 minutes.

Note : switched off, the fault is not memorised.

Resetting

Compressor mn can only be restarted after re-closing the internal protection and **manual** reset.

Note : The fault is cleared **automatically** every time the machine is switched on.

Trouble-shooting

Fault on supply to internal protective relay.
Discharge sensor badly wired or defective (possible with hermetic reciprocating compressors).
Superheat setting too high.

Solution

Check supply to relay.
Check sensor connection and replace if necessary.

Check superheat setting.

MISCELLANEOUS FAULTS

CONTENTS

	Page
INSUFFICIENT FLOW ESTABLISHED BY THE PUMP	45
FANS CIRCUIT BREAKERS TRIPPED	46
PUMP CIRCUIT BREAKER TRIPPED	47
REMOTE INSTRUCTION UNDETECTED	48
TEMPERATURE OF FREE-COOLING OUTSIDE RANGE	49
DIALOGUE BETWEEN CPU AND KP07 INTERRUPTED	50

INSUFFICIENT FLOW ESTABLISHED BY THE PUMP

Logical variable: **DSDEBk**

Incident codes KP02 : **81** (pump 1)
82 (pump 2)

KP07 icon: 

Description

Pump k supplying the evaporator has had the operational command for **20 seconds**.
The "flow switch" FSE detects insufficient flow in the exchanger for over **25 seconds**.

Action

Case ①: The unit has **one pump only, or no pump** (C2POMPE = 0).

- ☞ Immediate halt of pump k.
- ☞ The fault is displayed on the screen.
- ☞ The remote fault report is delayed for 6 minutes.
- ☞ 22 seconds before generation of the fault, the machine has been stopped with the fault "insufficient flow of chilled water" (see page 27).

Case ②: The unit has two pumps (C2POMPE = 1).

- ☞ Immediate halt of pump k.
- ☞ Start-up of the 2nd pump (see chapter "control of evaporator pumps " page 4).
- ☞ The fault is displayed on the screen.
- ☞ The remote fault report is delayed for 6 minutes.

Resetting

Case ① : If the CLIMATIC detects water circulation when no command has been issued to operate POMPEk (meaning that the pump is not electrically controlled by the automatic controller), the machine restarts **automatically** 20 seconds after flow is re-established.
Otherwise, the machine can only be restarted after a **manual** reset.

Case ② : If the flow is re-established within 20 seconds following the start command to the 2nd pump, the machine restarts **automatically**.
Otherwise, the unit can only start up again after a **manual** reset.

Trouble-shooting

Wiring fault on the control pump.
Wiring fault on the flow controller.
Water filter clogged.
Flow controller wrongly set.

Solution

Check the pump connection.
Check the connection on the flow controller.
Clean the water filter.
Adjust the flow controller setting.

FAN CIRCUIT BREAKERS TRIPPED

Logical variable: **DELECV**

Incident codes KP02: **90**

KP07 icon:



Description

One or more thermomagnetic circuit breakers protecting the air condenser fans are tripped. (ELECV = 0).

Action

- ☞ The fault is displayed on the screen.
- ☞ The remote fault report is delayed for 6 minutes.

Resetting

The fault is cleared **automatically** once all the fan circuit breakers are reset.

Trouble-shooting

Bad connection or connections too tight.
Circuit breakers wrongly set.

Solution

Check connections.
Set protections according to the rated current for fans.

PUMP CIRCUIT BREAKER TRIPPED

Logical variable: **DELECPk**

Incident codes KP⁹¹ (pump 1)
KP⁹² (pump 2)

KP07 icon: 

Description

The thermomagnetic circuit breaker on pump k is tripped (ELECpk = 0).

Action

Case ①: Pump k is in service and the unit has **only one pump** (C2POMPE = 0).

- ☞ Immediate halt of pump k
- ☞ Immediate machine halt
- ☞ The fault is displayed on the screen.
- ☞ The remote fault report is delayed for 6 minutes.

Case ②: Pump k is in service and the unit has **two pumps** (C2POMPE = 1).

- ☞ Immediate halt of pump k.
- ☞ Start-up of the 2nd pump (see chapter "control of evaporator pumps" page 4).
- ☞ The fault is displayed on the screen.
- ☞ The remote fault report is delayed for 6 minutes.

Case ③: Pump k is not in service.

- ☞ The fault is displayed on the screen.
- ☞ The remote fault report is delayed for 6 minutes.

Resetting

Case ①: The machine restarts automatically **20 seconds** after the fault has been cleared and the CLIMATIC has restarted the pump

Case ②: The fault is cleared **automatically** once the pump circuit breaker is reset

Case ③: The fault is cleared automatically once the pump circuit breaker is reset.

Trouble-shooting

Bad connection or connections too tight.
Circuit breaker wrongly set.

Solution

Check connections.
Set the protection in accordance with the rated current for the pump.

REMOTE INSTRUCTION UNDETECTED

Logical variable: **DCONS**

Incident codes KP02: **95**

KP07 icon:



Description

The unit should be regulated to the water instruction sent remotely by the customer (SGLCONS = 1), but the signal received is incorrect (TCONS < -25°C).

Action

- ☞ The machine is not stopped and is regulated to its own water instruction.
- ☞ The fault is displayed on the screen.
- ☞ The remote fault report is delayed for 6 minutes.

Resetting

Once TCONS > -25°C, the fault is cleared **automatically**.

The machine can once again be regulated to the remote instruction.

Trouble-shooting

Wiring fault on 4/20mA signal.

Solution

Check wiring (see wiring diagram).

TEMPERATURE OF FREE-COOLING OUTSIDE RANGE

Logical variable: **DTEFC**

Incident codes KP02: **97**

KP07 icon: 

Description

The inlet chilled water temperature, which is measured by the sensor located on the collector (forward free-cooling coils), is outside authorized range:

$$TEEGFC < -15^{\circ}\text{C} \text{ or } TEEGFC > 65^{\circ}\text{C}$$

Action

- ☞ Immediate halt of free-cooling (free-cooling fans stop and the 3 way valve completely by-pass the coils)
- ☞ The fault is displayed on the screen.
- ☞ The remote fault report is delayed for 6 minutes.

Resetting

Automatic fault resetting, as soon as inlet chilled water temperature is inside the normal operation conditions.

$$-13^{\circ}\text{C} < TEEGFC < 60^{\circ}\text{C}$$

Trouble-shooting

Sensor fault on free-cooling water inlet.
Wiring fault or disconnection of sensor.

Solution

Replace sensor.
Check sensor connection.

DIALOGUE BETWEEN CPU AND KP07 INTERRUPTED

Logical variable: -

Incident codes KP02: -

KP07 icon:



Description

After 3 attempts, the KP07 VDU has not succeeded in establishing a dialogue with at least one of the CPU cards connected to it.

Action

- ☞ Regular attempts to restore communication.
- ☞ The fault is displayed on the screen.
- ☞ The remote fault report is delayed for 6 minutes.

Resetting

The fault is cleared **automatically** once dialogue is restored.

Trouble-shooting

Wiring fault on link between the KP07 and the CPU.
Power failure on one of the cards.

Solution

Check the connection of the link between the cards.
Check electrical supply to cards.

KP02 DIGITAL CONSOLE

1. GENERAL PRESENTATION

The KP02 console is a man-machine interface consisting of a 6 digit display, 6 indicator lights and 5 keys.

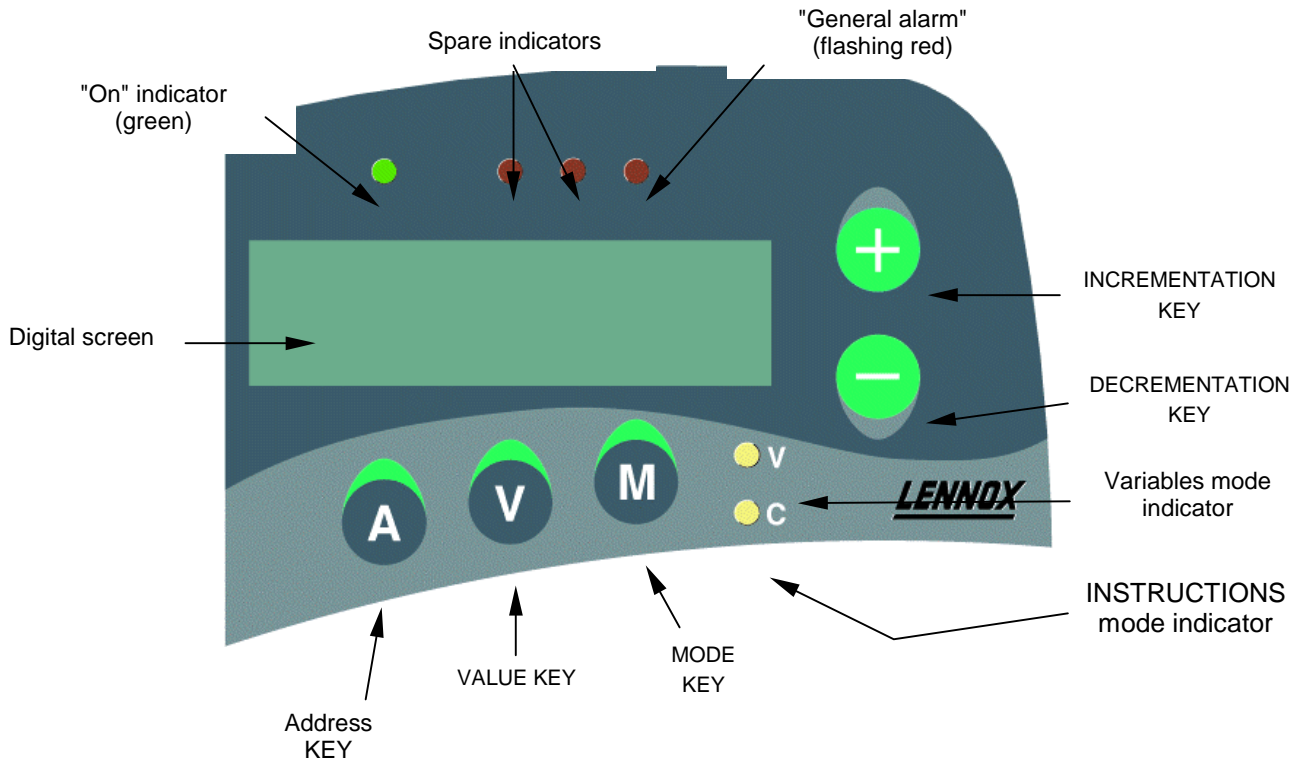

This console is principally used to read and/or modify the values of variables or instructions for the CPU card to which it is connected.

Dialogue with the CPU is initiated by the KP02. If, after 3 attempts, communication is not established, a message indicating the communication problem is displayed (see §II.5.c). The console will then make regular attempts to reconnect.

Data transmission speed is 1200 baud, in 8-bit format (1 start, 8 bits, odd parity, 1 stop).

2. DISPLAY FORMATS

2.1. Time



When the console keypad is inactive for 5 minutes, the time is automatically displayed.

KP02 DIGITAL CONSOLE

2.2. Date



2.3. Address of a variable

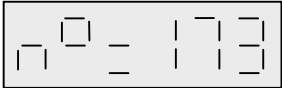

2.4. Value of a variable

2.4.1. Logical values

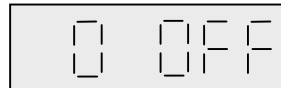
 (1 \Leftrightarrow ON) (0 \Leftrightarrow OFF)

2.4.2. Temperatures

The temperatures are displayed in °C, to nearest 0.1°C.

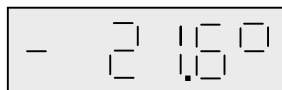
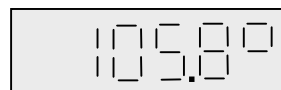
 \Leftrightarrow -21.6°C \Leftrightarrow +105.8°C

2.4.3. Pressures

The pressures are shown in bar, to nearest 0.1 bar.

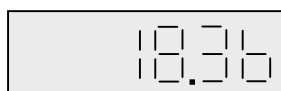
 \Leftrightarrow 18.3 bar

2.4.4. Other analogue values

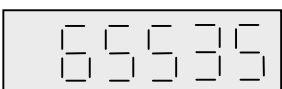
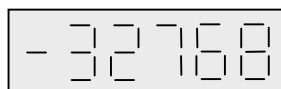
 Values without signs Signed values

2.4.5. Fault mode

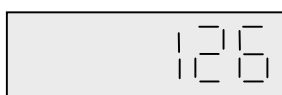
 \Leftrightarrow Discharge temperature too high on compressor 1 on circuit 2.

KP02 DIGITAL CONSOLE

When a fault occurs on the machine, the red led "general alarm" flashes. If the user wishes to know the nature of the fault, he can consult the variable "breakdown" representative of the code "breakdown".

2.5. Specific displays

2.5.1. Application release

When the console is switched on, the computer application release number is displayed.

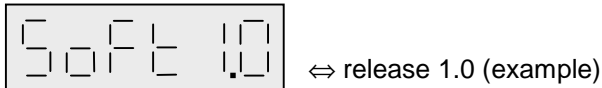

2.5.2. VDU test

Correct operation of the VDU can only be tested at the time the console is switched on, by pressing on the 3 keys "A", "M" and "-" simultaneously. Correct operation of the VDU is shown as follows:



2.5.2. KP02 / CPU communication fault

An absence of dialogue between the KP02 console and the CPU card is signalled by the permanent following message:

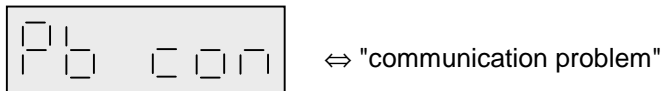

3. OPERATING MODES

4 modes are available:

1. VARIABLES mode is used to read the values of variables.
2. INSTRUCTIONS mode is used to modify setting instructions.
3. READ DATER mode is used to read the time and date.
4. SET DATER mode is used to modify the time and date.

The user selects the required mode by pressing the "M" key as many times as necessary.

Mode	Indicator "V"	Indicator "C"
VARIABLES	On	off
INSTRUCTIONS	Off	On
READ DATER	Off	Off
SET DATER	On	on

KP02 DIGITAL CONSOLE

3.1. VARIABLES mode

Pressing on "A" displays the address of the variable currently being read.

The address is incremented by pressing keys "A" and "+" simultaneously. The address is incremented slowly if "+" is pressed briefly, or faster if it is pressed continuously.

The address is decremented in a similar manner, using keys "A" and "-".

When the required address is selected, pressing key "V" displays the value of the corresponding variable. Variables are updated cyclically every n seconds.

Note: When an address is selected, if the user does not enter a value request, this takes place automatically after 1 minute.

3.2. INSTRUCTIONS mode

The address of the instruction to be modified is selected as for VARIABLES mode (see § 3.1.).

The value of the instruction is increased by pressing keys "V" and "+" simultaneously. The value increases slowly if "+" is pressed briefly, and faster if it is pressed continuously. Slow incrementation is by 0.1 for temperatures and pressures and 1 for other values. Fast incrementation starts with the rightmost digit then moves to the left.

Decrementation is in a similar manner, using keys "A" and "-".

As soon as key "V" is released, the value displayed is sent to the CPU.

Access to instructions other than CONSEA, CONSEB, DELTAT, MAARCn and RESET is restricted. For access to all instructions, a password must be entered in the reserved instruction at address no.0. If the password is correct, the following message is displayed when key "V" is released:

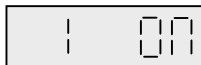

After 5 minutes of keypad inactivity, the console automatically cancels unlimited access to instructions. To modify a protected instruction the password must be re-entered.

3.3. READ DATER mode

Read accessible dater elements are :

. Time

↔

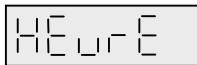

. and date

↔

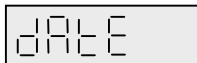

The element is selected by holding key "A" pressed down and pressing briefly on "+" or "-".

KP02 DIGITAL CONSOLE

Pressing key "V" displays the value of the selected data item.

Note: If the user does not press "V", the value appears automatically after 1 minute.

3.4. SET DATER mode

This mode can be used to adjust the 6 dater elements:

. hours and minutes	⇔	HEurE
. the day of the month	⇔	Jour
. the day of the week	⇔	Jour 5
. the month	⇔	MOIS
. the year	⇔	AnnEE

The element to be modified is selected as for READ DATER mode.

In the same way as for instructions, incrementation of the value is by simultaneously pressing keys "V" and "+", and decrementation by simultaneously pressing "V" and "-".

For the different types of data, setting ranges are as follows :

Item	Minimum value	Maximum value
Hours and minutes	00-00H	23-59H
Day of the month	1	31
Day of the week	1	7
Month	1	12
Year	0	99

Pressing key "A" saves the value entered.

Note: Months with less than 31 days are not automatically checked on entry. If a day is entered which is not compatible with the current month, the value is refused at dater level and the old day is retained.
Examples:

	Day of the month		
	Current value	Value entered	Final value
02 (February)	15	30	15
10 (September)	26	31	31

KP07 VDU (VISUAL DISPLAY UNIT) CONSOLE

1. GENERAL PRESENTATION

The KP07 console is a man-machine interface with a black and white liquid crystal graphics screen, back-lit, with definition 240 x 128 pixels. It also has 2 indicator lights and 12 keys.

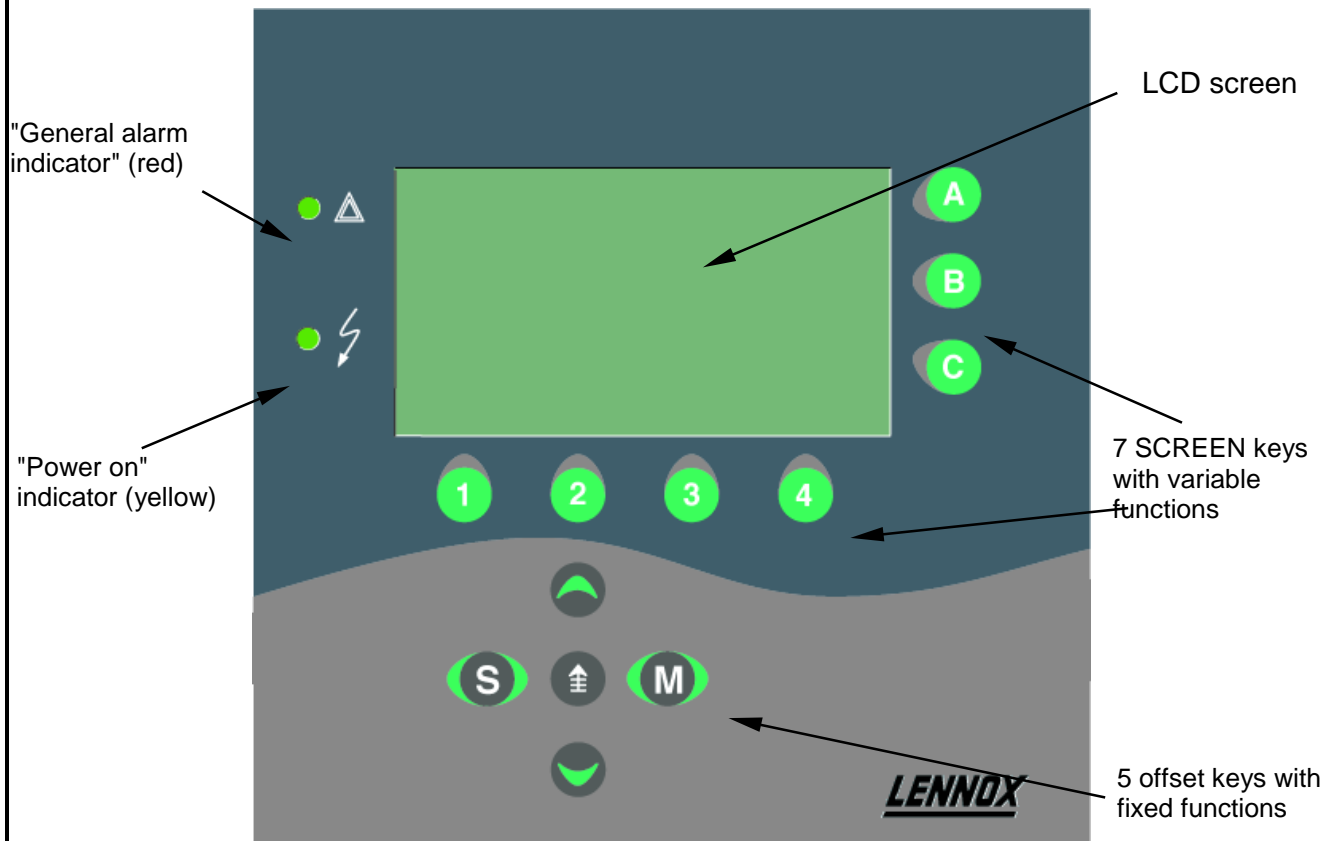

The principal functions of the console are:

- Management of the tree structure of interactive screens.
- Permanent updating of all dynamic parameters displayed on the different screens.
- Saving successive states of predefined variables to be used for analogue and event logs.

A KP07 console can be connected to a maximum of 8 distinct controllers, on condition that they all have the same structure of variables. The number of controllers connected is declared in the application program for the VDU. If a single CPU is connected, its card number is also declared.

The controller / VDU link is serial type and uses JBUS protocol. On connection, the console tries to establish a dialogue with the declared controllers. If, after 3 attempts, the console cannot communicate with a controller, the latter is set to "disconnected" status. The link problem is then displayed on the screen (if the disconnected controller is selected for operator dialogue) and saved in the event log. The KP07 then makes regular attempts to reconnect.

Communication speed is 4800 baud. Data is transferred in 8-bit format (1 start, 8 bits, odd parity, 1 stop).

KP07 VDU (VISUAL DISPLAY UNIT) CONSOLE

1.1. Key allocation

1.1.1. SCREEN keys

These are the 7 keys located around the LCD screen:







The function of these keys may vary from one screen to another, and is defined on the active screen by an icon. For keys "1", "2" "3" and "4", the icon is displayed above the key. For the other 3 keys "A", "B" and "C", the icon is displayed to their left.

Each key offers the possibility:

- of accessing another screen.
- or entering a Boolean value in a given variable.









1.1.2. Offset keys

The functions of these 5 keys are fixed.

	PAGE DOWN key :	Go to the next page of the same type of screen.
	PAGE UP key :	Go back to the previous page of the same type of screen.
	SUMMARY key :	Go back to the first screen in the tree structure –c-to-d summary)
	LAST SCREEN key :	Return to the last screen selected.
	MODIFICATION key :	Pressing this key activates " modification " mode (see § 1.2.)

1.2. "Modification" mode

This mode is used to modify the values of all modifiable variables displayed on the active screen. This mode uses the 4 keys "1", "2", "3" and "4", assigning them pre-defined functions:

Key	Associated icon	Key function
		Selection of the variable to be modified.
		Selection of the number to be modified. (Press the key successively to move the cursor, digit by digit, from the right to the left, then the cursor is repositioned on the last digit of the value to be changed.)
		Incrementation of the digit from 0 to 9.
		Confirmation of the current modification.

KP07 VDU CONSOLE

"Modification" mode offers the user the following main possibilities:

- Selecting the number of the controller on which variables are to be displayed (where several KP01 cards are connected to the same KP07 console)
- Setting instructions
- Configuration of on/off switches on circuits.

To exit from "modification" mode and return to the active screen, press MODIFICATION key.

Notes:

- During the modification phase, the screen is no longer updated.
- If a modification is not confirmed, the variable remains at its previous value.

1.3. Contrast adjustment

Contrast on the display unit is adjusted in "modification" mode (see § 1.2):

- Press successively on key A to increase contrast.
- Press successively on key B to reduce contrast.
- Key C is used to restore the contrast setting by default (see § 2. **VDU CONSOLE** ➤ **KP07**).

KP07 VDU CONSOLE

2. GENERAL TREE STRUCTURE OF SCREENS

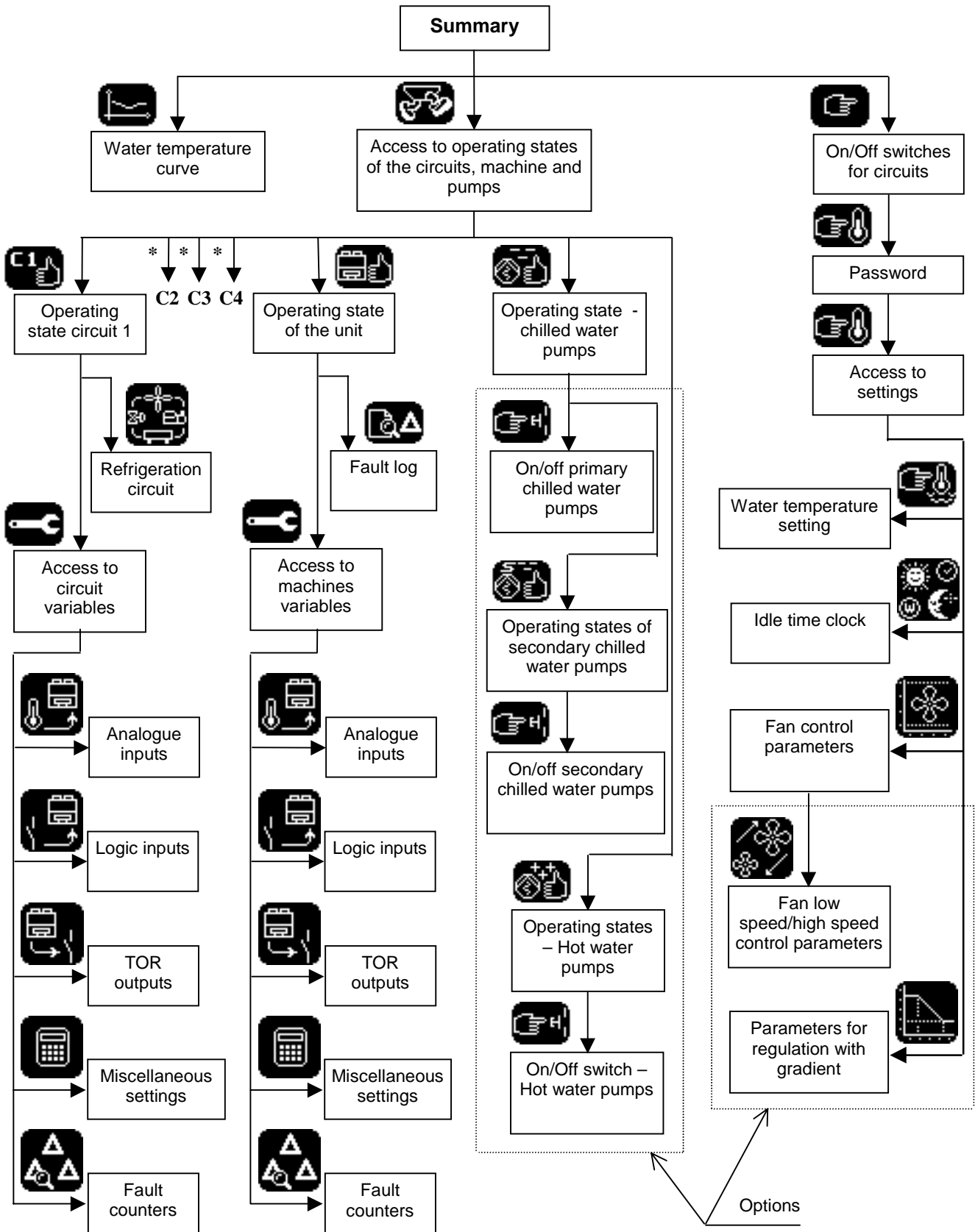

* For units with more than one refrigeration circuit, branches C2, C3 and C4 corresponding to operating states for circuits no. 2, 3 and 4, are active.

KP07 VDU CONSOLE

3. CONTENT OF SCREENS

3.1. Summary

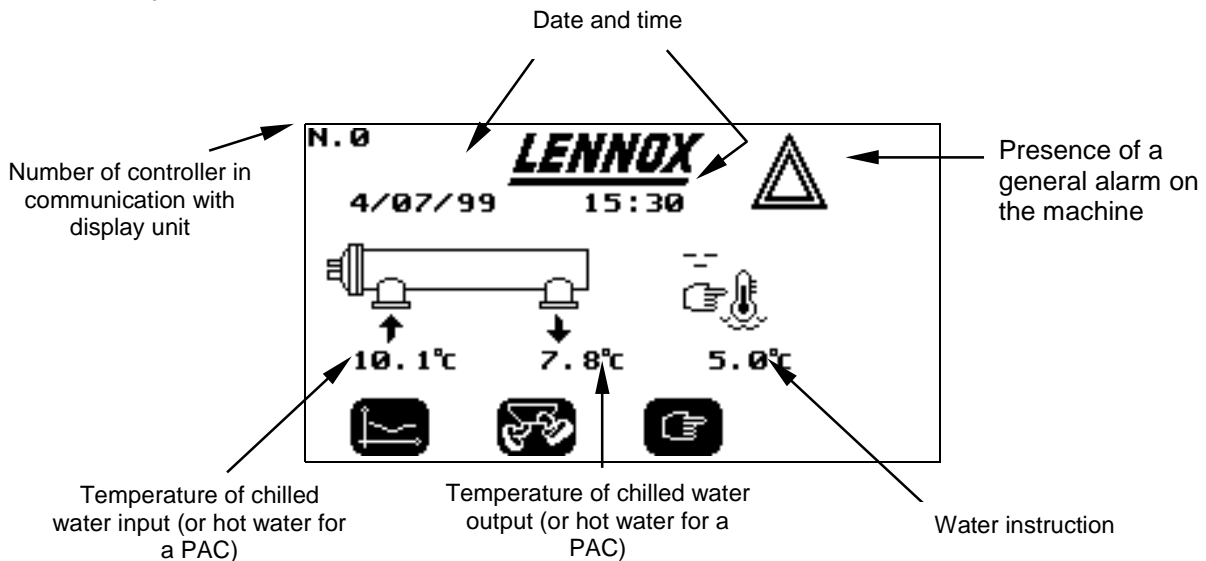

On a machine not fitted with the option "regulation with gradient", the active water instruction (CONSEA or CONSEB) is a variable which can be modified in "modification" mode. In the case of regulation with gradient, the active instruction CONSEA can be modified. However CONSALC cannot be modified, since it is the result of a calculation (see pages 15 and 16).

Where several KP01 cards are connected to the same KP07, the controller number can also be modified. On all other screens, the controller number can only be read.

Date and time data can also be changed. Every 24 hrs, the console automatically reads the date and time on the lowest JBUS address controller and sends this information to any other controllers connected to it.

3.2. Water output temperature curve

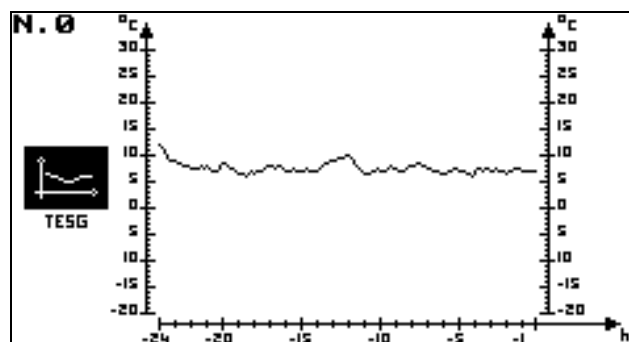

The monitoring frequency for the temperature of chilled water output (or hot water for a PAC) is 10 minutes, over a complete 24 hour cycle. The console therefore memorises the last 144 values of the monitored variable.

KP07 VDU CONSOLE

3.3. Access to the different operating states

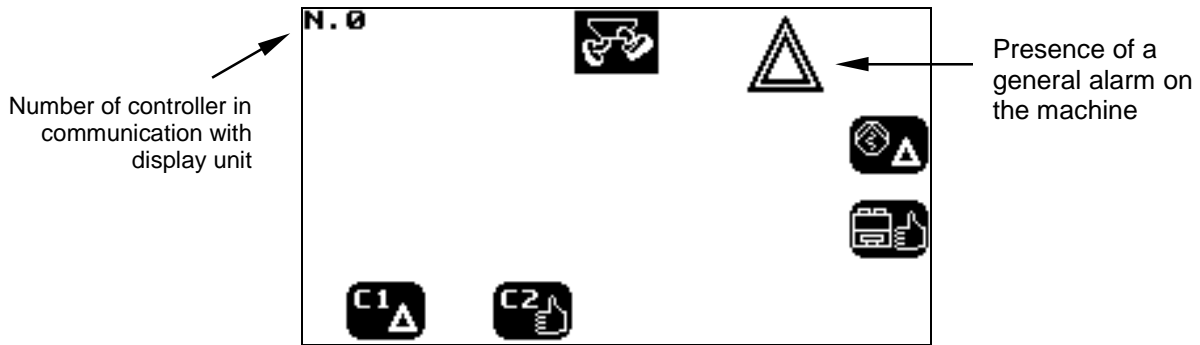

This screen gives access to the operating states of the refrigeration circuits, pumps and machine.

3.4. Operating states of refrigeration circuits

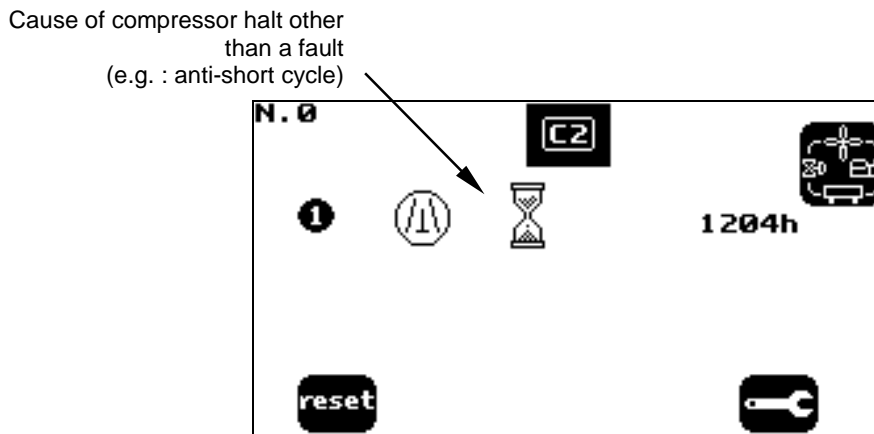
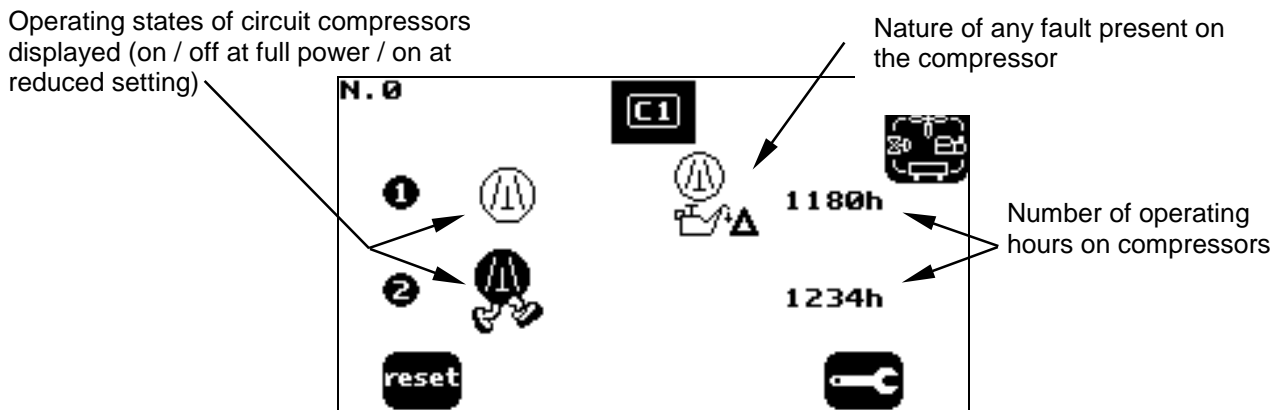

KP07 VDU CONSOLE

3.5. Refrigeration diagrams

3.5.1. Air condensation units

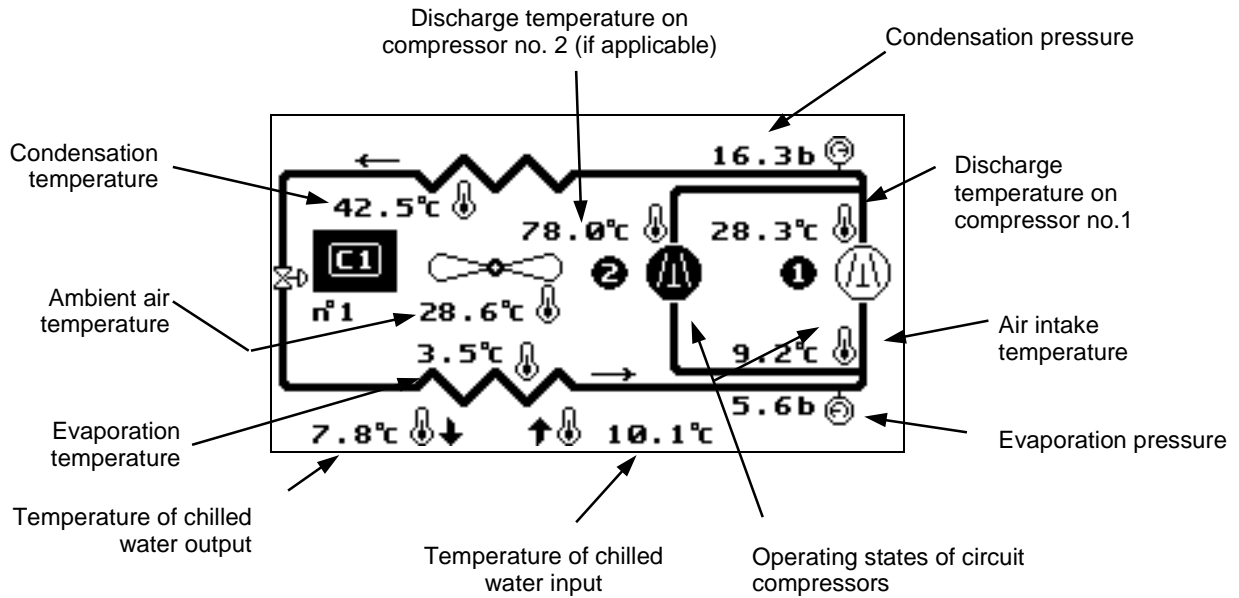

3.5.2. Water cooled condensers

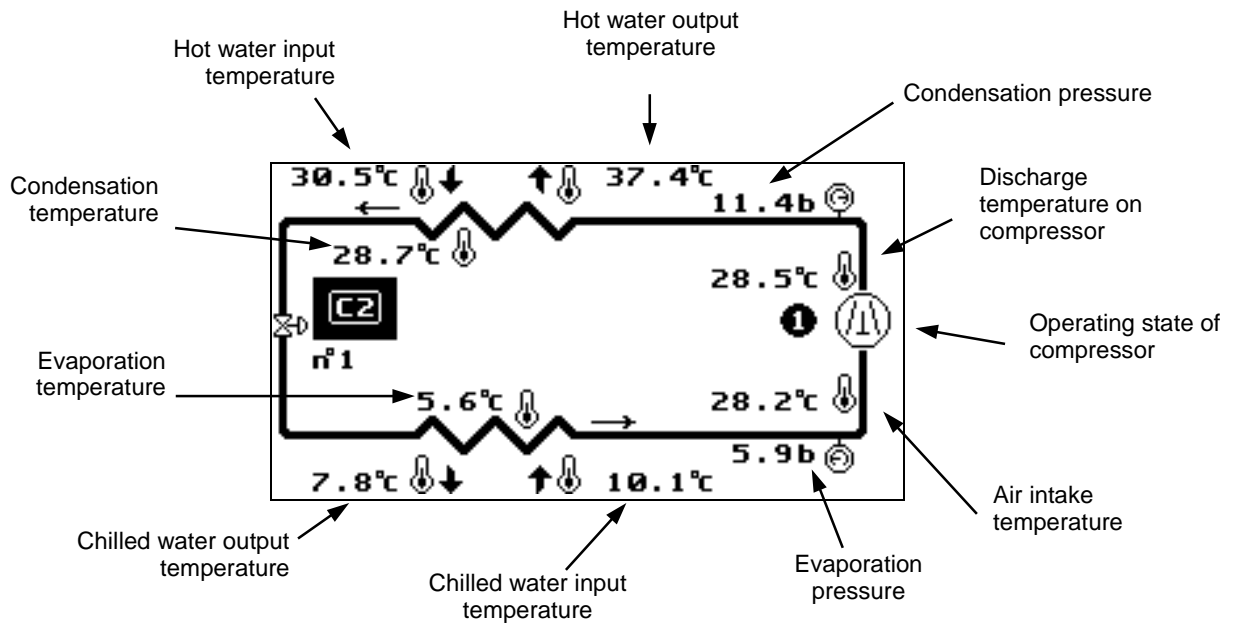

KP07 VDU CONSOLE

3.6. Tables of variables associated with refrigeration circuits

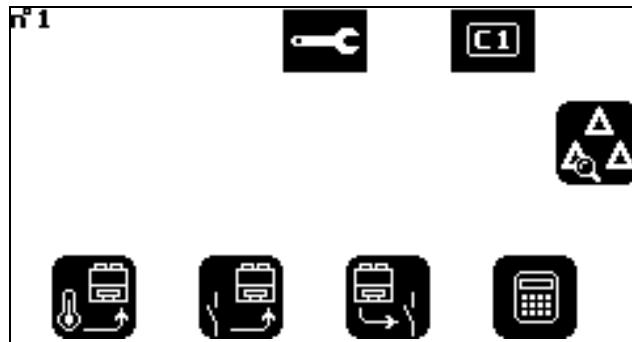

This screen gives access to the values of logic inputs, fault counters, TOR output and other variables describing the selected refrigeration circuit. Each variable is identified by its mnemonic.

3.6.1. Analogue inputs

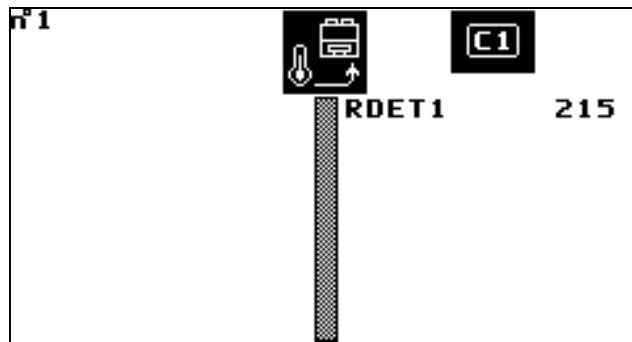

This screen shows the analogue inputs for the refrigerant circuit which are not shown in the refrigerant diagram screens described in § 3.5. (e.g. opening of electronic expansion valve).

3.6.2. Logic inputs

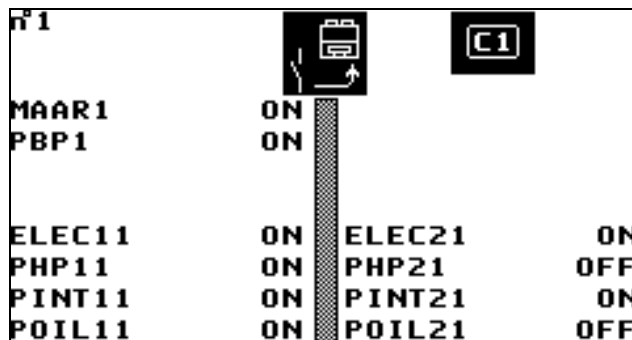

This screen shows the state of all the logic inputs associated with the circuit and its compressors.

KP07 VDU CONSOLE

3.6.3. TOR outputs

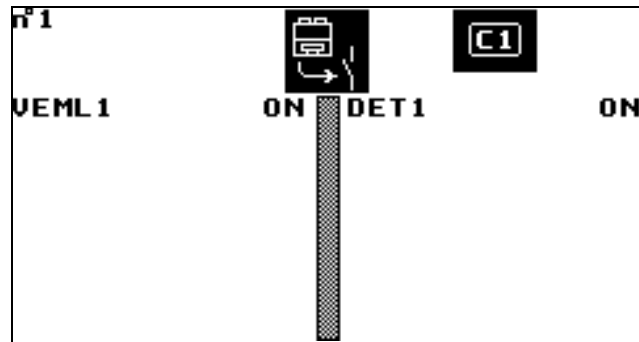

This screen displays the state of the actuators which control circuit components other the compressors, whose operation has already been described in operating states for circuits (see § 3.4.).

3.6.4. Fault counters

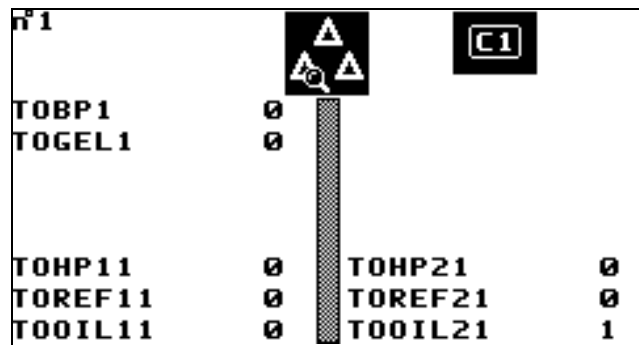

This screen shows the values of counters for all faults on the circuit and its compressors.

KP07 VDU CONSOLE

3.6.5. Miscellaneous settings

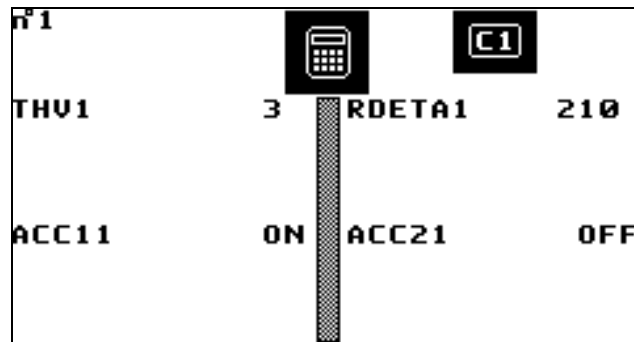

This screen displays the calculated values of significant circuit variables such as the anti-short cycle of compressors, the ventilation thermostat or the order of position given to the expansion valve.

3.7. Pump operating states

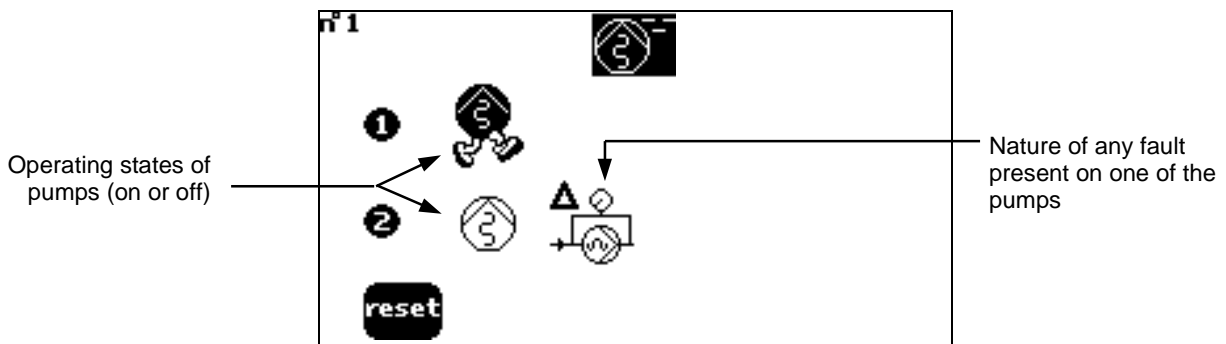

3.8. Machine operating states

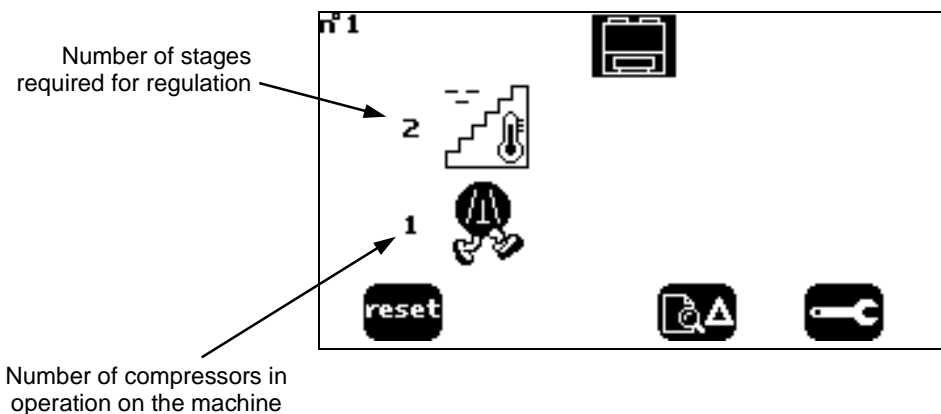

KP07 VDU CONSOLE

3.9. Tables of general variables

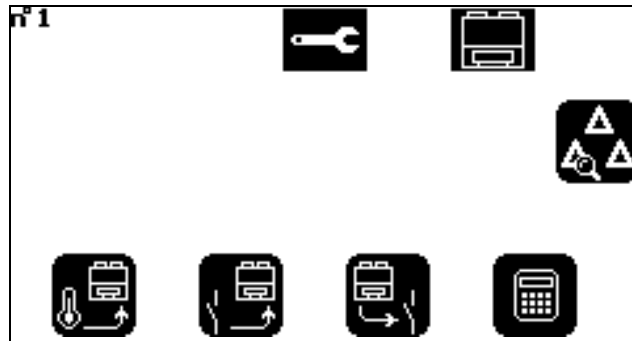

This screen gives access to the values of analogue inputs, logic inputs, TOR outputs, fault counters, and other variables relating to the entire machine (not related to a specific refrigeration circuit). Each variable is identified by its mnemonic.

3.9.1. Analogue inputs

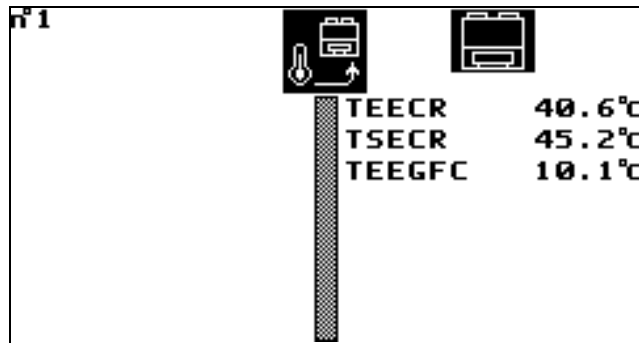

This screen contains the temperatures associated with specific options (e.g. temperatures of chilled water at input to free-cooling or hot water at I/O to a heat recovery exchanger).

3.9.2. Logic inputs

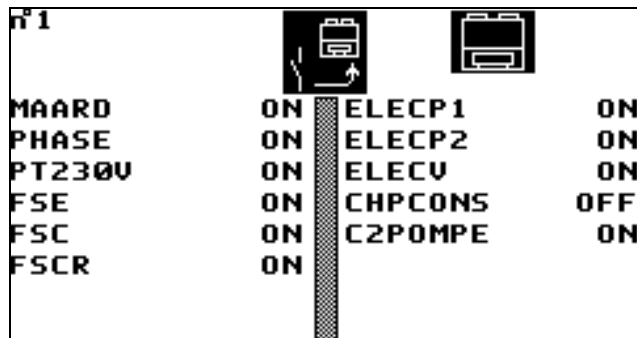

This screen shows the states of contacts which have an effect on the overall operation of the machine (e.g.: remote on / off, circuit breakers for pumps, choice of setting instruction, etc.)

KP07 VDU CONSOLE

3.9.3. TOR outputs

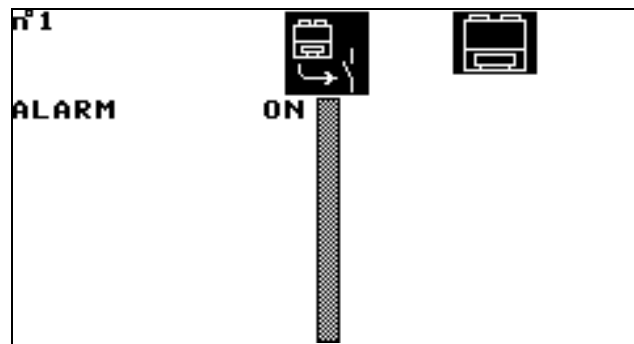

This screen displays the state of the actuators which control machine components other than those already described in operating states for circuits and pumps (e.g. general alarm).

3.9.4. Fault counters

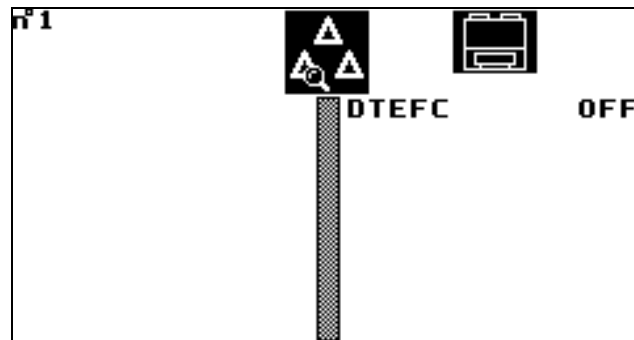

Faults and fault counters associated with specific options appear on this screen (e.g. temperature of water input to free-cooling outside range).

3.9.5. Other variables

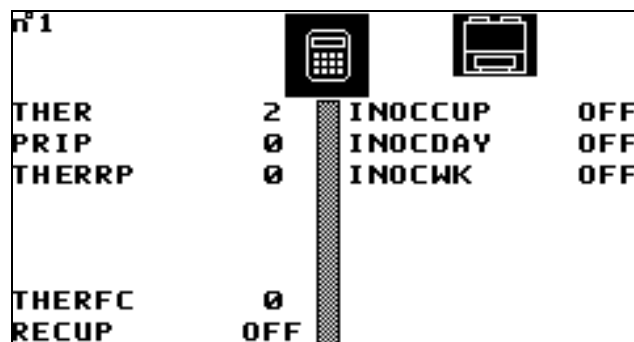

This screen gives the values of calculated variables which apply to the entire machine. (e.g.: priority status for pump operation, pump operation, idle functions, etc.)

VDU CONSOLE KP07

3.10. Fault log

n°1		[Magnifying Glass]	
2	--Δ	29/02	1 C2
		8:36	
1	C1	1/05	1/11
		7:44	21:33
		14/07	25/12
		9:53	0:13
			1 C1
			1/01
			6:46

The event log allows recording of the last 24 changes of state related to faults.

Depending on the configuration chosen in the console application program, either fault occurrences only, or fault occurrences and clearances are taken into account.

The log displayed relates only to the controller which is currently in communication with the display unit. If other KP01 cards are linked to this display unit, their respective event logs can be accessed by modification of the controller number in the summary screen (see § 3.1.).

3.11. On / off switches on refrigeration circuits

n°1		[Hand]		[Hand]	
C1	H ₁	ON			
C2	H ₁	ON			

This screen can be used to configure authorisation to switch on each refrigeration circuit, or to keep it switched off, using "modification" mode.

After pressing key **M**, the screen shows:

n°1		[Hand]	
C1	H ₁	OFF	
C2	H ₁	ON	

VDU CONSOLE KP07

3.12. Instructions

Access to the different setting instructions is protected by a password (a modifiable variable consisting of 5 figures). This is entered via "modification" mode.



Entry of the password, followed by validation, activates key "A":



Pressing key "A" displays the screen below, enabling the user to access the type of instruction he/she wishes to adjust.

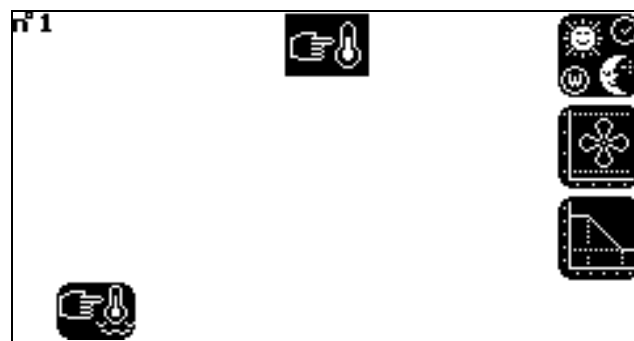

All the instructions which follow can be adjusted via the "modification" mode.

KP07 VDU CONSOLE

3.12.1. Water temperature instructions

The screen shown below corresponds to the case of a liquid cooler. There is a similar screen for heat pumps.

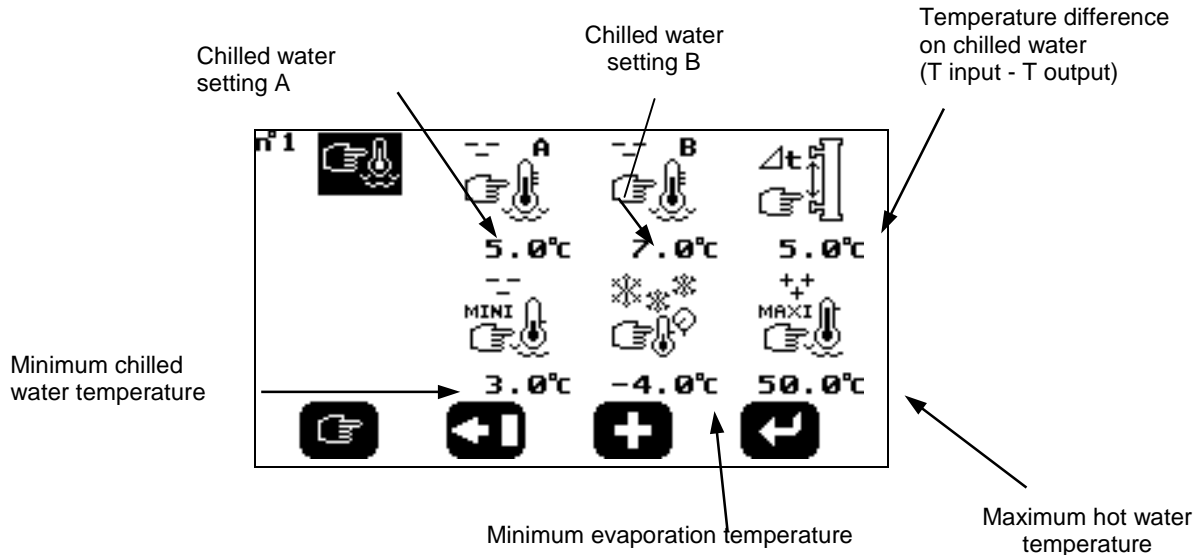

3.12.2. Idle time clocks

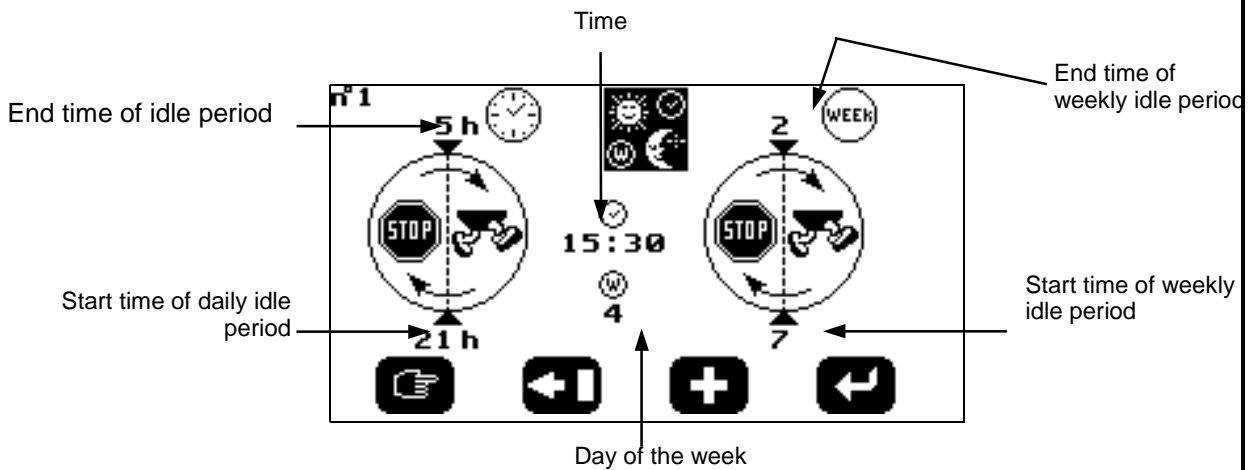

Like the instructions displayed on this screen, the date and time are modifiable variables.

For days of the week, value 1 is Sunday and 7 is Saturday.

KP07 VDU CONSOLE

3.12.3. Control parameters for condenser ventilation (specific for chillers with air cooled condensers)

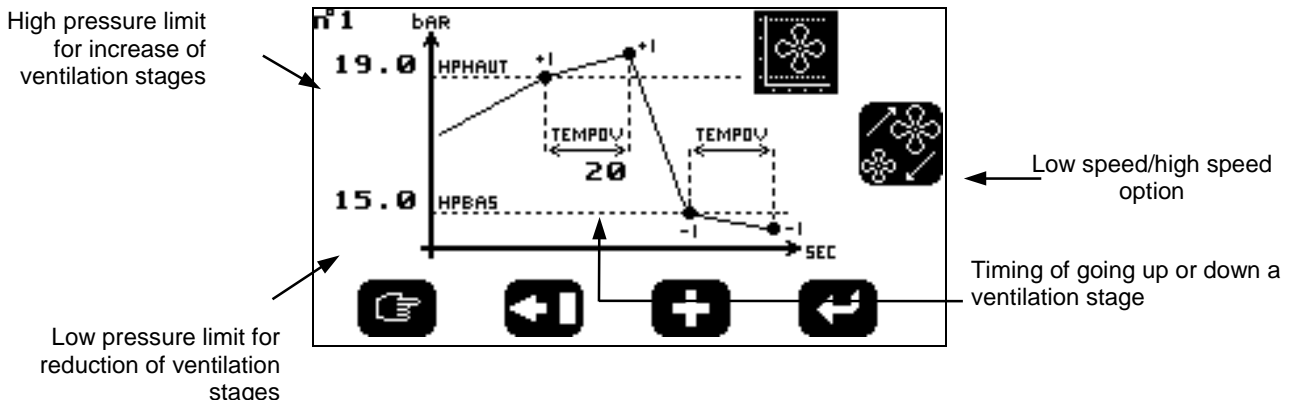

3.12.5. Control parameters for condenser ventilation in PV / GV (option specific to air condensation machines)

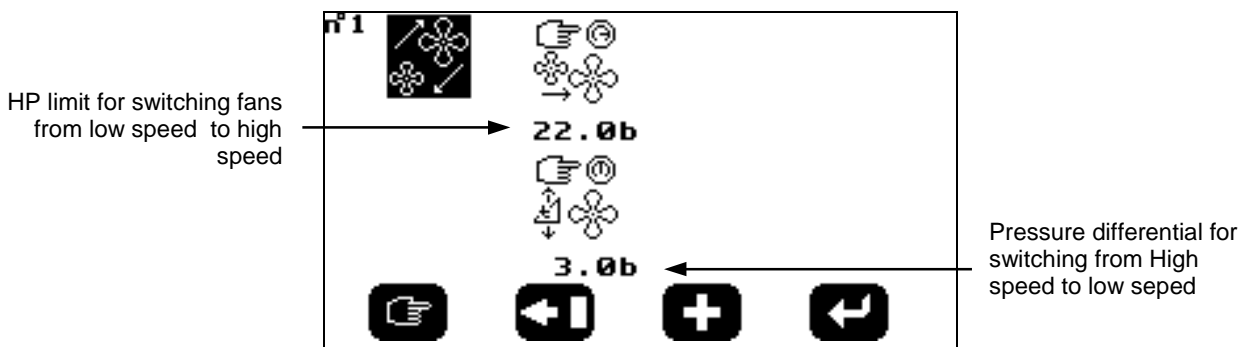

3.12.6. Parameters for regulation with gradient on air temperature (option)

The screen below corresponds to the case of a liquid chiller

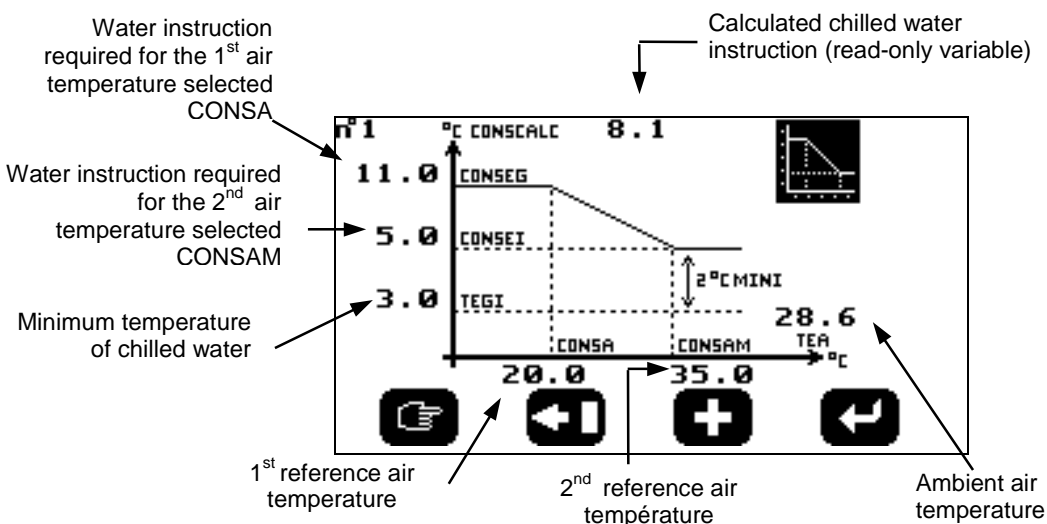

KP07 VDU CONSOLE

4. GLOSSARY OF ICONS

Icons are classed in 6 categories:

1. Keys
2. Screen headings
3. Identification of components
4. Operating states
5. Faults
6. On / off settings and instructions

IV.1. Keys



Access to the temperature curve for water output from machine.



Access to operating states for refrigeration circuits, pumps and machine



Access to operating state for refrigeration circuit no.1 (no faults are reported on the circuit)



Access to operating state for refrigeration circuit no.1 (there is a fault on the circuit).



Access to operating state for refrigeration circuit no.2 (no faults are reported on the circuit).



Access to operating state for refrigeration circuit no.2 (there is a fault on the circuit).



Access to operating state for refrigeration circuit no.3 (no faults are reported on the circuit).



Access to operating state for refrigeration circuit no.3 (there is a fault on the circuit).



Access to operating state for refrigeration circuit no.4 (no faults are reported on the circuit).



Access to operating state for refrigeration circuit no.4 (there is a fault on the circuit).



Access to operating states for chilled water pumps (no faults are reported on the pumps).



Access to operating states for hot water pumps (no faults are reported on the pumps).



Access to operating states for secondary chilled water pumps (no faults are reported on the pumps).



Access to operating states for secondary chilled water pumps (there is a fault on the pumps).



Access to operating states for hot water pumps (there is a fault on the pumps).



Access to operating states for hot water pumps (there is a fault on the pumps).



Access to operating state for machine (there is a fault on the machine).



Access to operating state for machine (there is a fault on the machine).

KP07 VDU CONSOLE



Reset faults and fault counters to zero.



Access to refrigeration diagram for selected circuit.



Access to fault log.



Access to the different tables of variables.



Access to analogue inputs (other than those shown on refrigeration diagrams).



Access to logic inputs.



Access to TOR outputs.



Access to miscellaneous variables.



Access to fault counters.



Access to on / off controls and instructions. Selection of the variable to be modified (see §I.2.).



Selection of figure to be modified (see §I.2.)



Incrementation of figure from 0 to 9 (see §I.2.).



Validation of current modification (see §I.2.).



Access to on / off controls for refrigeration circuits and for pumps



Access to the various instructions.



Access to water temperature instructions.



Access to idle timers (day / night).



Access to control parameters for condenser fan.



Access to low / high speed control parameters for condenser fan.



Access to parameters for regulation with gradient on air temperature.

KP07 VDU CONSOLE

4.2. Screen headings



Temperature curves for water output from the machine.



Access to operating states for refrigeration circuits, pumps and machine.



Operating state of refrigeration circuit no.1.



Operating state of refrigeration circuit no.2.



Operating state of refrigeration circuit no.3.



Operating state of refrigeration circuit no.4.



Operating state of chilled water pumps.



Operating state of secondary chilled water pumps.



Operating state of hot water pumps.



Operating state of machine.



Fault log.



Access to the different tables of variables.



Analogue inputs (other than those shown on refrigeration diagrams).



Logic inputs.



TOR outputs



Miscellaneous variables.



Fault counters.



On / off controls for refrigeration circuits.



On / off controls for primary chilled water pumps.



On / off controls for secondary chilled water pumps.



On / off controls for hot water pumps.



KP07 VDU CONSOLE



Password entry for access to modifiable instructions.



Access to the various instructions.



Water temperature instructions.



Idle timers (day / night).



Control parameters for condenser fan.



Low / high speed control parameters for condenser fan.



Parameters for regulation with gradient on air temperature.

4.3. Identification of components



Machine.



Refrigeration circuit no. 1



Refrigeration circuit no. 2



Refrigeration circuit no. 3



Refrigeration circuit no. 4



Compressor or pump no. 1 (in " circuits or pumps " operating states respectively).



Compressor or pump no. 2 (in " circuits or pumps " operating states respectively).



Compressor no. 1 for refrigeration circuit no. 1



Compressor no. 2 for refrigeration circuit no. 1



Compressor no. 1 for refrigeration circuit no.



Compressor no. 2 for refrigeration circuit no. 2

VDU CONSOLE KP07



Compressor no. 1 for refrigeration circuit no. 3



Compressor no. 1 for refrigeration circuit no. 4



Primary chilled water pump no. 1



Primary chilled water pump no. 2



Secondary chilled water pump no. 1.



Secondary chilled water pump no. 2.



Hot water pump no. 1.



Hot water pump no. 2.

4.4. Operating states



Stages required for chilled water regulation.



Stages required for hot water regulation.



Compressor in operation (representation on refrigeration diagram).



Compressor in operation.



Compressor in operation at full capacity.



Compressor in operation at reduced capacity.



Compressor operating at 75% of its total capacity



Compressor operating at 50% of its total capacity.



Compressor operating at 25% of its total capacity.

VDU CONSOLE KP07



Compressor stopped (representation on refrigeration diagram).



Compressor stopped.



Compressor stopped for regulation



Compressor stopped in anti-short cycle.



Compressor stopped by idle timers



Compressor stopped by non operation of pump or pump stopped



Compressor stopped by refrigeration circuit on/off.



Compressor stopped by remote on / off command to machine.



Pump in operation.



Free-cooling in operation.



Free-cooling stopped.

4.5. Faults



On the unit, presence of a machine, circuit compressor or miscellaneous fault

4.5.1. General machine faults



Chilled water temperature outside authorised range



Hot water temperature outside authorised range.



Chilled water flow insufficient.

KP07 VDU CONSOLE



Hot water flow insufficient.



Absence of power on 230 V electrical supply to the machine.



Incorrect connection of 3 phases of general electrical supply to the machine.



Electronic starter fault.

4.5.2. Faults on the refrigeration circuit



Low pressure insufficient.



Evaporator freezing.



Superheat insufficient.



Vacuum draught on circuit not achieved.



Temperature sensors or pressure detectors faulty.



Incorrect opening of expansion valve.

4.5.3. Compressor faults



Tripping of thermomagnetic circuit breaker for compressor.



Insufficient oil pressure.



Excess high pressure.



Discharge temperature too high.



Tripping of internal protection for compressor.

KP07 VDU CONSOLE

4.5.4. Miscellaneous faults



Insufficient water flow although operational command has been issued to pump.



Tripping of thermomagnetic circuit breaker for at least one fan.



Tripping of thermomagnetic circuit breaker for pump.



Water tank level or pressure insufficient.



Bad reception of 4/20 mA signal transmitted remotely for water instruction.



Chilled water temperature at the input of free cooling outside authorised range.



Dialogue interrupted between KP07 console and a CPU card on the network.



KP07 / KP01 dialogue re-established.

4.6. On / off settings and instructions



On / off refrigeration circuit no. 1.



On / off refrigeration circuit no. 2.



On / off refrigeration circuit no. 3.



On / off refrigeration circuit no. 4.



On/Off pump no. 1.



On/Off pump no. 2.



First chilled water setting (CONSEA).



Second chilled water setting (CONSEB).



Chilled water instruction calculated according to air gradient (CONSCALC)

KP07 VDU CONSOLE



First hot water setting (CONSEA).



Second hot water setting (CONSEB).



Hot water recuperation instruction (CONSECR)



Desired temperature difference, as an absolute value, between processed water input and output (DELTAT)



Minimum chilled water temperature (TEGI).



Maximum hot water temperature (TECS).



Minimum evaporation temperature (TBPI).



HP limit for switching fans from low to high speed (HPGV).



Pressure differential for switching fans from high to low speed (HPDIFF).



Maximum number of compressors which can operate in load shedding mode (THERMAX).

ELECTRONIC CARD DATA

CONTENTS

	Page
CLIMATIC CARD ➤ KP01.....	82
EXTENSION - 16 LOGIC INPUTS ➤ KP03.....	87
EXTENSION – ANALOGUE OUTPUT ➤ KP04.....	89
EXTENSION - 8 ANALOGUE INPUTS ➤ KP05	91
EXTENSION - 8 RELAYS ➤ KP08.....	93
DAUGHTER CARD – DIGITAL OUTPUT 0-10 V ➤ KP09.....	95
EXTENSION - +18VDC SUPPLY ➤ KP10	96
FEMALE CARD – ANALOGUE OUTPUT ➤ KP11	97
DIGITAL CONSOLE ➤ KP02.....	98
VDU CONSOLE ➤ KP07	99

CLIMATIC CARD ➤ KP01

1. PRESENTATION

The main KP01 card is fitted with a microprocessor 68HC16, an EPROM containing the program for regulation of the machine and a battery used to supply power to the dater and to save important operational data in the event of a power cut.

In its basic version, a KP01 card has:

- 8 logic inputs
- 8 analogue inputs
(An optional KP10 card, generating an 18 Vdc supply, can be installed on the KP01 to supply the 0-20 mA sensors.)
- 8 logic outputs
- 2 asynchronous serial links designed for dialogue with a PC, a GTC or a digital or VDU console

As an option, the addition on the KP01 of 2 KP11 daughter cards or 2 x KP09 or 1 x KP11 + 1 x KP09 gives control of 2 0-10 V analogue outputs or 2 0-10V digital outputs or 1 analogue output + 1 digital output, respectively.

The architecture of the CLIMATIC is modular, using extension cards. The following can be connected to the same KP01:

- ☞ 3 extensions - 16 logic inputs (KP03 card)
- ☞ 4 extensions - analogue output (KP04 card)
- ☞ 3 extensions - 8 analogue inputs (KP05 card)
(Each KP05 added takes up an analogue input on the KP01.)
- ☞ 4 extensions - 8 supplementary logic outputs (KP08 card)

In the case where the requirement for inputs / outputs on a machine exceeds the capacities of a single KP01, or if there is a need for communication to be established between different units on the same site, chaining of several KP01 cards, with their accompanying extensions, may be envisaged (maximum 8 KP01, with a maximum distance between cards of 100 m).

2. EXTERNAL LINKS

2.1 Power supply

A single transformer supplies power to the CLIMATIC (KP01, extensions and KP07)

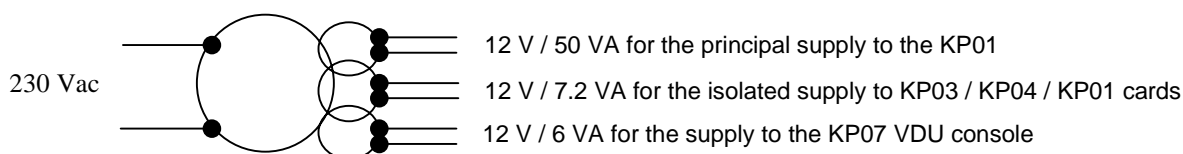

Connection to KP01:

- . 12 V principal supply + Earth ➔ 3 point plug-in connector, pitch 5.08 mm (J10)
- . 12 V isolated supply ➔ 2 point plug-in connector, pitch 5.08 mm (J11)

The presence of a power supply to the KP01 power supplies is indicated by 2 green leds (LD3 for 12V principal and LD2 for 12V isolated).

CLIMATIC CARD ► KP01

2.2 Logic inputs

Logic inputs are basically linked to hard contacts from control equipment installed on the machine (e.g. pressostats, magneto-thermal circuit breakers, flow controller, etc.)

Connection is by a 12 point plug-in connector, pitch 3.81 mm (J26). Wiring of machine equipment to a logic input can be in unscreened cable. However, screened cable must be used for connection to the terminals provided for the customer's use.

2.3 Analogue inputs

Analogue inputs can be used to connect CTN temperature sensors (10 k Ω at 25°C) or pressure transmitters. All 0-20 mA sensors, whatever the quantity measured, must have a supply connection to a KP10 card connected to the KP01 at J23.

Connection to analogue inputs is by a 12 point plug-in connector, pitch 3.81 mm (J25). In addition, the 18 V dc voltage generated by the KP10 is transmitted to the KP05 extension cards via a 2 point plug-in connector, pitch 3.81 mm (J24).

2.4 Logic outputs

The inverter type actuator relays are used in particular for on-off control of "motorised" components of the machine, such as compressors, fans and solenoid valves. They can also be used to transmit logical information on hard contacts fitted to terminals.

Connection is by a 3 point plug-in connector, pitch 5.08 mm (J1 to J8). The relays have a 12 V power supply.

2.5 0-10 V outputs

Analogue outputs (associated with KP11 daughter cards) are used for variable control by 0-10 V signal. The equipment controlled may be a damper motor or a modulating valve.

The 0-10 V digital outputs (associated with KP09 daughter cards) can be used for on-off control, with frequent state change and via static relays, of components such as solenoid valves or heating resistors.

Connection to KP09 or KP11 cards is by 2 point plug-in connectors, pitch 3.81 mm (J17 & J21).

2.6 Link with extension cards

This link is based on an I²C bus, connecting the KP01 to KP03, KP04 and KP08 extensions.

Connection is by RJ45 type connectors (J14 & J15).

2.7 Analogue bus

This link is used to connect the KP01 to KP05 extensions.

Connection is by an HE10 14 point plug-in connector, pitch 2.54 mm (J19).

CLIMATIC CARD ➤ KP01

2.8 Inter-KP01 chaining link

The KP01s communicate with each other by an asynchronous serial link which uses 3 signals:

- . Transmission / reception
- . Reference mass
- . Power supply

The different KP01 cards are connected to each other via 3 point plug-in connectors, pitch 3.81 mm. A yellow flashing led signals correct dialogue between the KP01 (LD4).

2.9 Serial link

All KP01 cards have 2 communication ports, named COM B and COM C respectively. COM B can be used to connect a KP07 VDU console, a micro-computer or a GTC. The COM C port is designed solely for a link with a KP02 digital console or a KP07 VDU console (the choice of the type of console is made via microswitch no.8 on SW1).

The asynchronous serial link uses the following 4 signals:

- . TXD: transmission of CLIMATIC data
- . RXD: reception of CLIMATIC data
- . GND: reference mass for the 2 signals TXD and RXD
- . Power supply

The characteristics of the COM B link are as follows:

- . Communication speed configurable, via a JBUS gateway: baud rate 4800 (by default), 2400 or 1200
 - . Parity: odd
 - . Data format: 8 bits
 - . Number of stop bits: 1

Connection to both COM ports is by 4 point plug-in connector, pitch 3.81 mm (J14 / J15). Each port is fitted with a yellow led which flashes when dialogue between the KP01 and the end device is OK (LD6 for COM B / LD5 for COM C).

Note: Any connection of a PC to a KP01 requires the installation of an RS232 interface. In the same way, CLIMATIC dialogue with a GTC must go through a KP06JBUS gateway.

3 CONFIGURATION

3.1 Battery (switch SW4):

When the card is in use, SW4 must be on (T) so that data can be backed up. During storage or breakdown periods, it is recommended to turn the battery off (R) to stop it discharging unnecessarily.

Caution: the dater does not work if the battery is not switched on.

CLIMATIC CARD ➤ KP01

3.2 Analogue inputs (switches SW5-1 to SW5-8):

These jumpers allow configuration of the type of analogue input: CTN or 0-20 mA.

If one of the first 3 analogue inputs is invalid due to the presence of a KP05 extension, the corresponding switch (SW5-1 to SW5-3) must be set to zero position, i.e. withdrawn.

3.3 COM C port (microswitch SW1-8):

The 8th block of the SW1 switch is used to configure the type of console, digital or VDU, connected to the port.

3.4 Chaining link (switches SW2,SW3):

If several KP01s are linked together, the switches should be set as shown in the table below:

	Card 0 master (internal supply)	Card n>0 slave (external supply)
SW2	1-2	2-3
SW3	1-2	2-3

By default, a KP01 is configured as slave.

4. KP01 CARD REPLACEMENT PROCEDURE

- Note all instruction values.
- Turn off the power supply to the card and replace the card.
- Take the EPROM from the old card and fit it to the new one, positioning it as shown below:

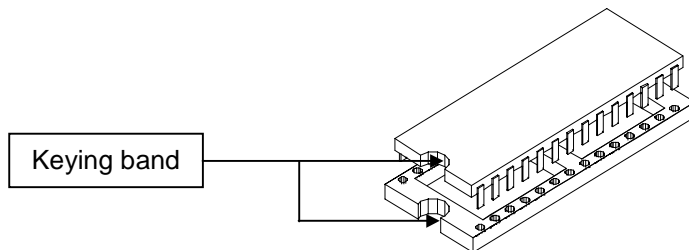

- Set the battery jumper to the on position and set the other jumpers to the same positions as on the old card.
- Reconnect all connections on the CLIMATIC, referring to the wiring diagram.
- Switch the power supply to the card back on and enter the old instructions on the new card.

① **Caution: never connect or disconnect I²C connectors when the power supply to the card is on.**

CLIMATIC CARD ➤ KP01

5. CARD DIAGRAM

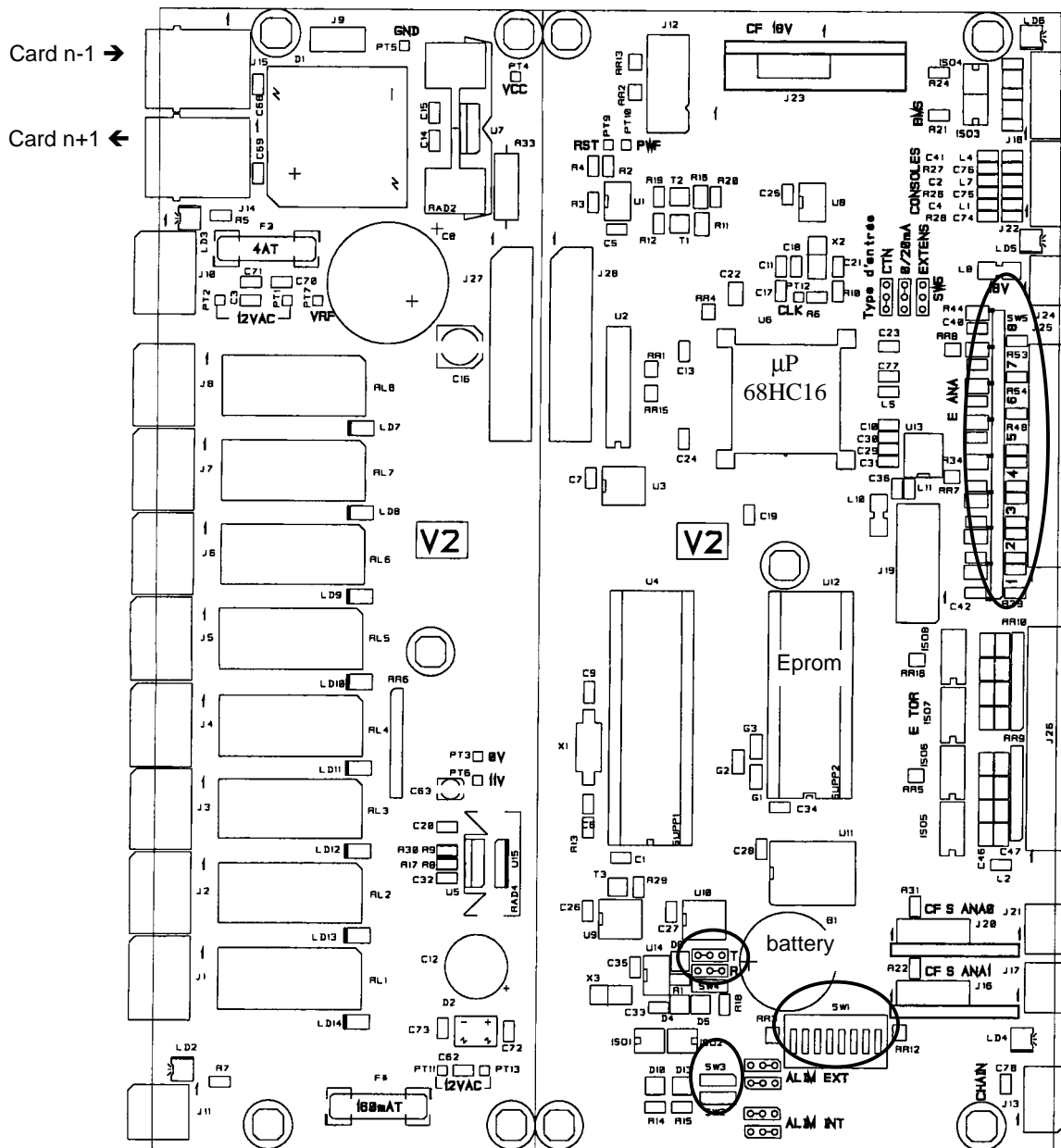

J1 to J8:	Connectors - 8 output relays	LD5, LD6:	Leds presence of dialogue on COM C / B
J10:	Connector - 12 Vac supply + T	PT1, PT2:	12 Vac
J11:	Connector - 12 Vac isolated supply	PT3:	0 V isolated
J13:	Connector - chaining link	PT4:	Vcc +5 V
J14, J15:	RJ45 connectors - I ² C bus	PT5:	Gnd
J16, J20:	Connectors for KP11 or KP09	PT6:	11 V isolated
J17, J21:	Connectors - 2 0-10 V outputs	PT7:	VRF 12 Vdc
J18, J22:	Connectors - 2 serial links	PT9:	Reset
J19:	Connector - analogue bus	PT10:	Power Fail
J23:	Connector for KP10	PT11, PT13:	12 Vac isolated
J24:	Connector - +18 Vdc supply	PT12:	Clock
J25:	Connector - analogue inputs	SW1:	DIL Microswitches
J26:	Connector - logic inputs	SW2, SW3:	Chaining link config. switches
LD2:	Led presence of 12 Vac isolated power	SW4:	Battery config. switch
LD3:	Led presence of 12 Vac	SW5:	Analogue input config. switches
LD4:	Led presence of chaining dialogue		

EXTENSION - 16 LOGIC INPUTS ➤ KP03

1. PRESENTATION

The KP03 card allows connection of 16 additional hard contacts to the CLIMATIC. These are mainly from control devices installed on the machine, such as pressostats, magneto-thermal circuit-breakers, flow controller, etc.

It is possible to connect up to 3 KP03 extensions to the same KP01, giving a maximum capacity of $8 + 3 \times 16 = 56$ logic inputs.

2. EXTERNAL LINKS

2.1 Power supply

The 12 Vac power supply to the KP03 cards is external. It is provided by the single transformer which generates the 12 V power supply for all CLIMATIC CPU and extension cards (see § ② of the technical data "CLIMATIC CARD ➤ KP01").

The 12 V supply to the KP03 is parasitic, since it is also the source of power for all the hard contacts which are connected to the logic inputs (unscreened cables).

Connection of the power supply is via a 2 point plug-in connector, pitch 5.08 mm (J3).

The presence of power on the KP03 is shown by a green led (LD18).

2.2 Link with the KP01 and other KP03s

This link is based on an I²C bus, and uses 2 RJ45 type connectors (J1 & J2).

A green led signals the presence of power on the I²C bus from the KP01 (LD17).

2.3 Logic inputs

Each input accepts maximum 10 mA current at 10V.

Connection is by 2 x 12 point plug-in connectors, pitch 3.81 mm (JEL1 & JEL2). There is one shared point for 2 inputs. Wiring of machine equipment to a logic input can use unscreened cable. However, screened cable must be used for connection to the terminals provided for the customer's use..

The state of each of the 16 inputs is shown by a yellow led (LD1 to LD16).

3. ADDRESSING CONFIGURATION (SW1)

Possible address numbers are 1, 2 or 3. Two KP03 connected to the same KP01 cannot have the same address.

For each address, the position of the jumper to be used is shown on the card.

EXTENSION - 16 LOGIC INPUTS ➤ KP03

4. CARD DIAGRAM

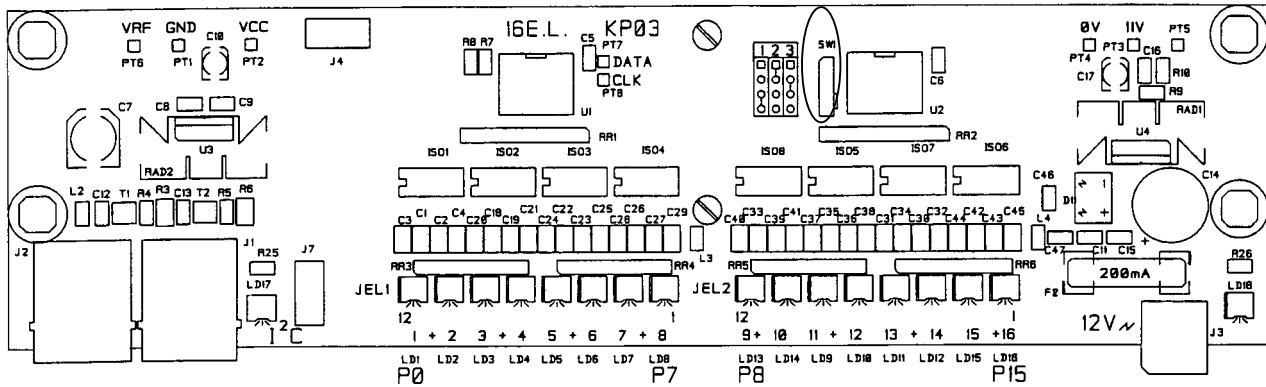

- J1, J2: RJ45 connectors for I²C Bus
- J3: Connector - 12Vac external power supply
- J4, J7: Locations for connection to earth using FASTON 6.35 earth lugs
- JEL1, JEL2: Logic input connectors
- LD1, LD16: LED status of 16 inputs
- LD17: LED presence of power on I²C bus
- LD18: LED presence of 12Vac
- PT1: Earth
- PT2: Vcc1 (+5V)
- PT3: Vcc2 (+11V isolated)
- PT4: 0V isolated
- PT5: +12V rectified and filtered (before regulation)
- PT6: VRF
- PT7: SDA/I²C signal (DATA)
- PT8: SCL/I²C signal (CLOCK)
- SW1: Switch for the configuration of the card address

EXTENSION - ANALOGUE OUTPUT ➤ KP04

1. PRESENTATION

The KP04 card allows the CLIMATIC to control an additional 0-10 V analogue output, via a digital / analogue converter. This type of output is used to control modulating equipment such as damper motors and proportional valves.

It is possible to connect up to 4 KP04 extensions to the same KP01, offering a maximum capacity of $2 + 4 \times 1$, = 6 analogue outputs.

2. EXTERNAL LINKS

2.1 Power supply

The 12 Vac power supply to KP04 cards is external. It is provided by the single transformer which generates the 12 V power supply for all CLIMATIC CPU and extension cards (see § ② of the technical data "CLIMATIC CARD ➤ KP01").

Connection of the power supply is by a 2 point plug-in connector, pitch 5.08 mm (J3).

The presence of power on the KP04 is shown by a green led (LD1).

2.2 Link with the KP01 and other KP04s

Based on an I²C bus, this link uses 2 RJ45 type connectors (J1 & J2).

A yellow flashing led signals that dialogue on the I²C bus is OK (LD2).

2.3 Analogue output

Connection is via a 2 point plug-in connector, pitch 3.81 mm (J4).

3. CONFIGURATION AND CALIBRATION

3.1 Addressing configuration (SW1 & SW2)

The possible address numbers are 1, 2, 3 or 4. Two KP04s connected to the same KP01 cannot have the same address.

For each address, the position of the jumper to be used is shown on the card.

3.2 Calibration (P1)

The potentiometer P1 allows adjustment of the gain to ensure voltage of 0 to 10 V on the analogue output. This adjustment is made systematically in the factory.

EXTENSION ANALOGUE OUTPUT ➤ KP04

4. CARD DIAGRAM

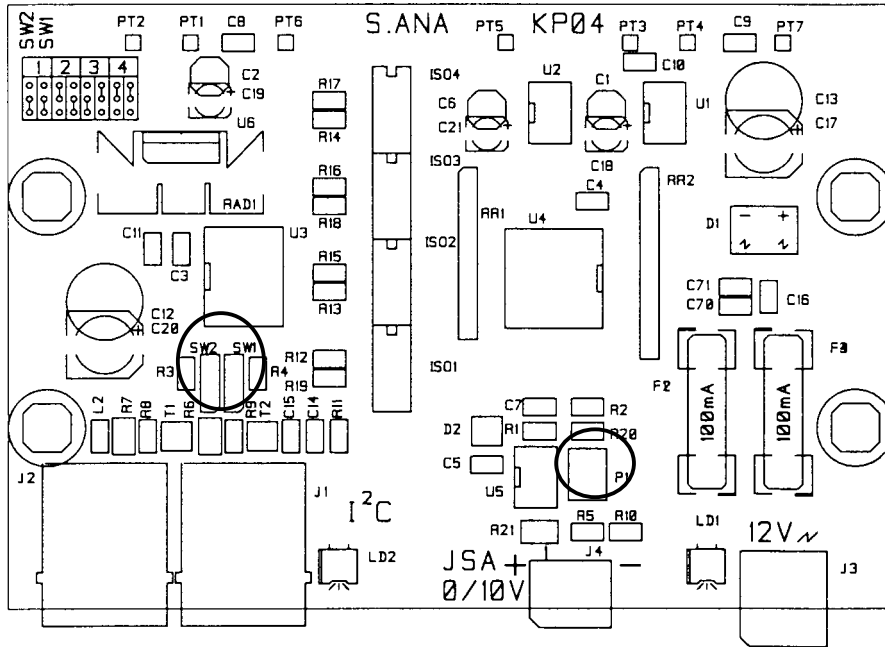

- F2, F3: 100 mA fuses
- J1, J2: RJ45 connectors for the I²C bus
- J3: Connector - 12 Vac external power supply
- J4 (JAS+): Connector - 0-10 V analogue output
- LD1: LED presence of 12 Vac
- LD2: LED presence of I²C dialogue
- P1: Potentiometer for card calibration
- PT1: Earth
- PT2: VRF
- PT3: +12V isolated
- PT4: 0V isolated
- PT5: +5V isolated
- PT6: Vcc (+5V)
- PT7: +12V rectified and filtered (before adjustment)
- SW1, SW2: Switches for configuration of the card address

EXTENSION - 8 ANALOGUE INPUTS ➤ KP05

1. PRESENTATION

The KP05 card allows the CLIMATIC to have 8 additional analogue inputs. The first 4 inputs can be connected either to a CTN type temperature sensor (10 kΩ at 25°C), or to a conventional 0-20 mA sensor. Inputs 5 to 8 are reserved for CTN temperature sensors.

It is possible to connect up to 3 KP05 extensions to the same KP01. Since each addition of a KP05 makes one KP01 analogue input unavailable, the complete configuration allows a maximum number of $5 + 3 \times 8 = 29$ analogue inputs.

2. EXTERNAL LINKS

2.1 Power supply

0-20 mA sensors require a 18 Vdc power supply. This power is generated by the additional KP10 card installed on the KP01 and is transmitted to the KP05 (see § ② "CLIMATIC CARD ➤ KP01" and § ① "EXTENSION +18 VDC POWER SUPPLY ➤ KP10").

Connection of the 18 Vdc power supply is by a 2 point plug-in connector, pitch 3.81 mm (J3).

2.2 Analogue bus

Transits between the KP05 and the KP01 via an HE10 14 point connector.

A green led indicates operation of the KP01 / KP05 link (LD1).

2.3 Analogue inputs

Connection is by a 12 point plug-in connector, pitch 3.81 mm (J1).

3. CONFIGURATION

3.1 Types of input (SW1 to SW8)

Each input is assigned a jumper. Depending on whether the input reads a CTN sensor or a 0-20 mA sensor, the position to be used for the jumper is marked on the card. Note that the last 4 inputs must be configured to CTN.

3.2 Addressing (SW9)

The possible address numbers are 1, 2 or 3. Two KP03s connected to the same KP01 cannot have the same address.

For each address, the jumper position to be used is shown on the card.

EXTENSION 8 ENTREES ANALOGUE ➤ KP05

4. CARD DIAGRAM

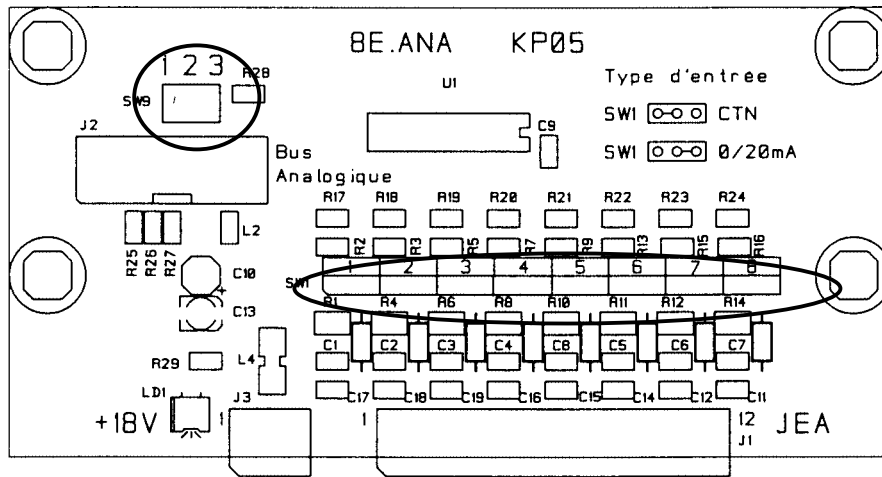

- J1 (JEA): Analogue input connector
J2: Analogue bus connector
J3: +18 Vdc power supply connector
LD1: Led presence of 5 V power
SW1 to SW8: Switches for configuration of 0-20 mA or CTN inputs
SW9: Switch for configuration of the card address.

EXTENSION 8 RELAYS ➤ KP08

1. PRESENTATION

The KP08 card allows the CLIMATIC to control 8 additional output relays. These actuators are used for on/off control of the principal electrical equipment on the machine, such as compressors, fans, solenoid valves and pumps. They can also be used to transmit logical information from hard contacts mounted on terminals.

Up to 4 KP08 extensions can be connected to the same KP01, offering a maximum capacity of $8 + 4 \times 8 = 40$ on/off outputs.

2. EXTERNAL LINKS

2.1 Link with KP01 and other KP08s

Based on an I²C bus, this link uses 2 RJ45 connectors (J9 & J10). They ensure the power supply to the KP08 from the KP01.

A green led indicates the presence of power on the I²C bus from the KP01 (LD1). A second yellow flashing led indicates that I²C dialogue is being carried out correctly (LD2).

2.1 Logic outputs

The relays mounted on the KP08 are inverter type. They accept a maximum intensity of 16 A at voltage 250 Vac.

Connection is by 3 point plug-in connectors, pitch 5.08 mm (J1 to J8).

3. ADDRESSING CONFIGURATION (SW1 & SW2)

The possible address numbers are 1, 2, 3 or 4. Two KP08 connected to the same KP01 cannot have the same address.

For each address, the positions of the 2 jumpers are shown on the card.

EXTENSION 8 RELAYS > KP08

4. CARD DIAGRAM

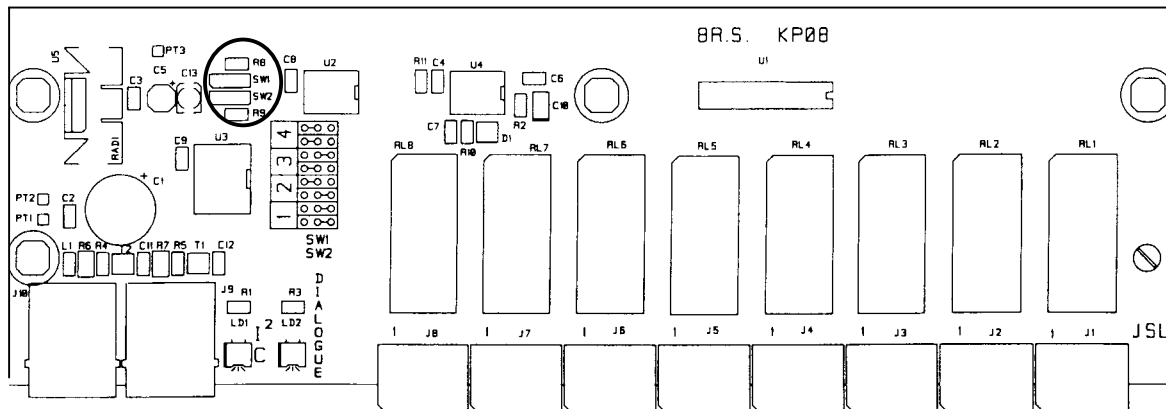

J1 to J8 (JSL): RL1 to RL8 relay connectors

J9, J10: RJ45 connector for I²C Bus

LD1: Led presence of I²C power

LD2: Led presence of I²C dialogue

PT1: VRF

PT2: Earth

PT3: Vcc (+5 V)

SW1, SW2: Switch for configuration of the card address.

DAUGHTER CARD 0-10V OUTPUT ➤ KP09

1. PRESENTATION

The KP09 module is presented in the form of a small plug-in card positioned on the KP01.

The KP09 delivers a 0 or 10 Vdc stepped signal. It is used in particular for on/off control, via static relays, of components requiring frequent on/off cycles (e.g. solenoid valves, heating resistors, etc.).

A CPU may receive at the most 2 KP09 or KP11 cards.

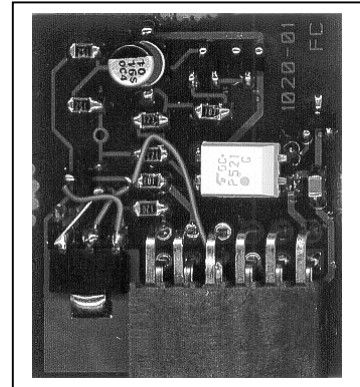

2. POSITIONING ON THE KP01

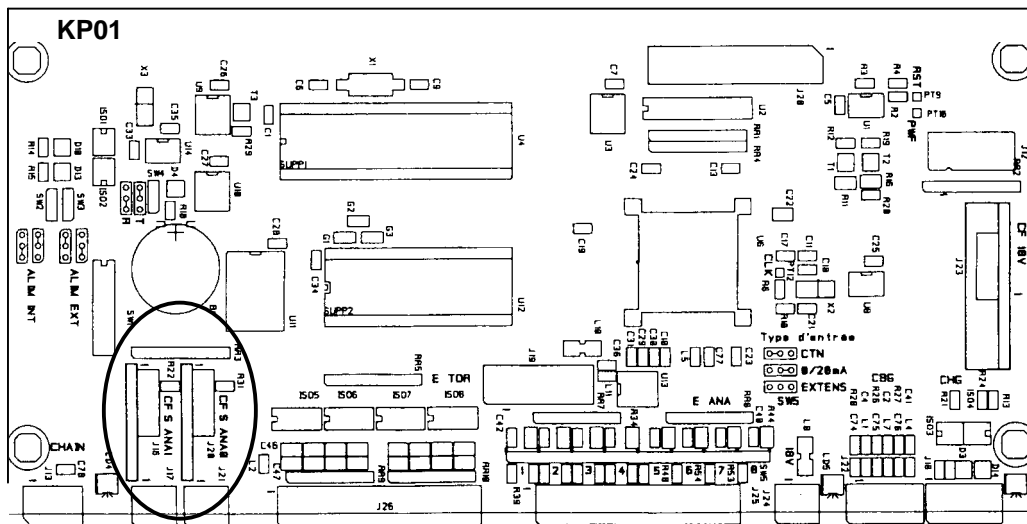

J16, J20: Connectors for KP09
J17, J21: Connectors of 2 outputs digital 0-10 V

ⓘ **Caution:** when installing the KP10 module, check compliance with orientation of the circuit as indicated by the markings printed on the KP01.

EXTENSION POWER SUPPLY +18VDC ➤ KP10

1. PRESENTATION

The KP10 extension is presented in the form of a small plug-in card positioned on the KP01.

It supplies power to the 0-20mA sensors connected to the KP01 and to KP05 extensions (see § "CLIMATIC CARD ➤ KP01" and "EXTENSION - 8 ANALOGUE INPUTS ➤ KP05").

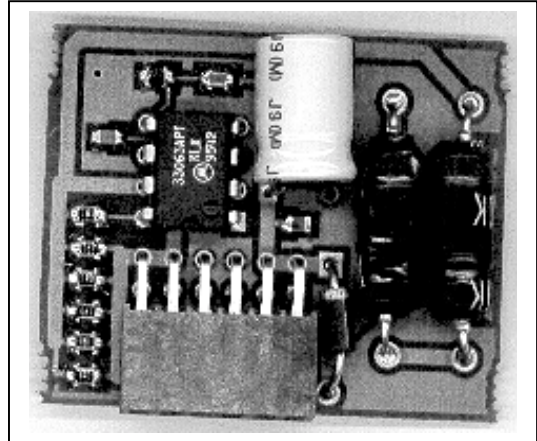

2. POSITIONING ON THE KP01

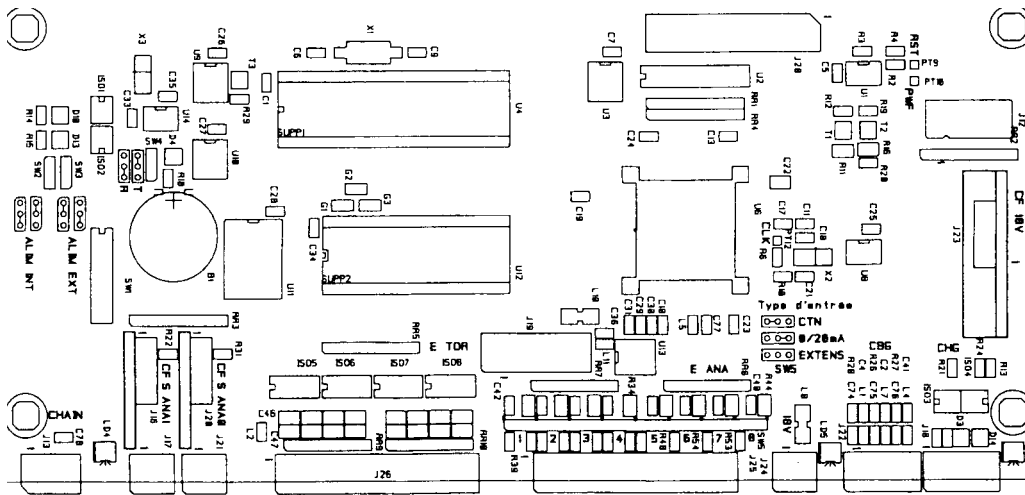

- J23: Connector for KP10
- J24: Connector +18 Vdc power supply output

ⓘ **Caution:** when installing the KP10 module, check compliance with orientation of the circuit as indicated by the markings printed on the KP01.

FEMALE CARD – ANALOGUE INPUT ➤ KP11

1. PRESENTATION:

The KP11 extension is presented in the form of a small plug-in card positioned on the KP01 unit.

The KP11 delivers 0-10 Vdc / 10 mA analogue power for automatic control of modulating devices such as the motors for dampers or proportional valves.

A CPU may receive 2 KP11 cards at the most.

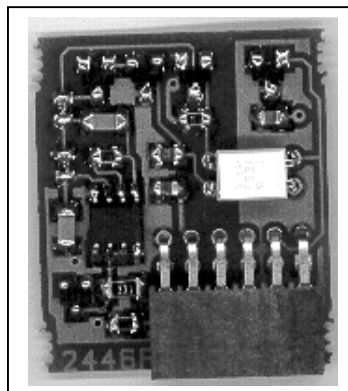

2. POSITIONING ON THE KP01

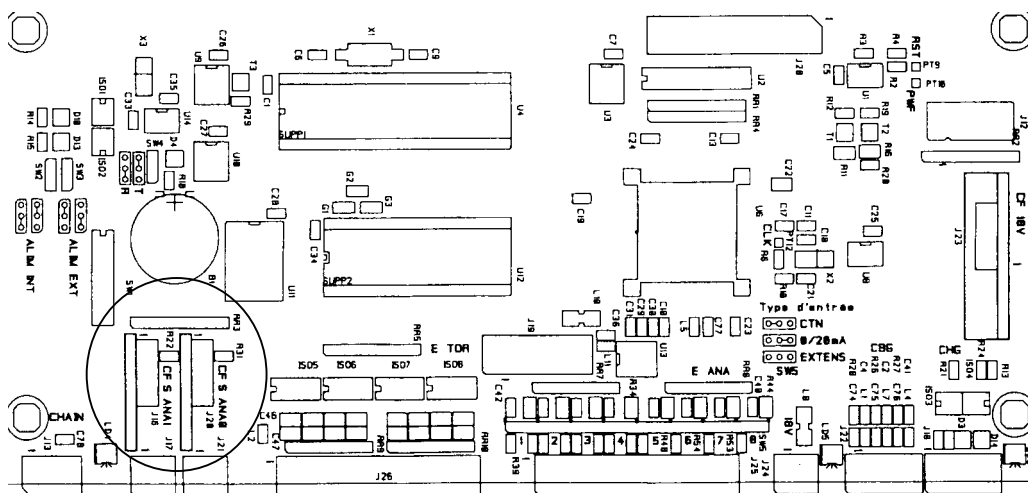

J16, J20: Connectors for KP11

J17, J21: Connectors for analogue outputs 0-10 V

- ⓘ **Caution:** when installing the KP11 module, check compliance with orientation of the circuit as indicated by the markings printed on the KP01

DIGITAL CONSOLE ➤ KP02

PRESENTATION

See § I chapter "KP02 DIGITAL CONSOLE"

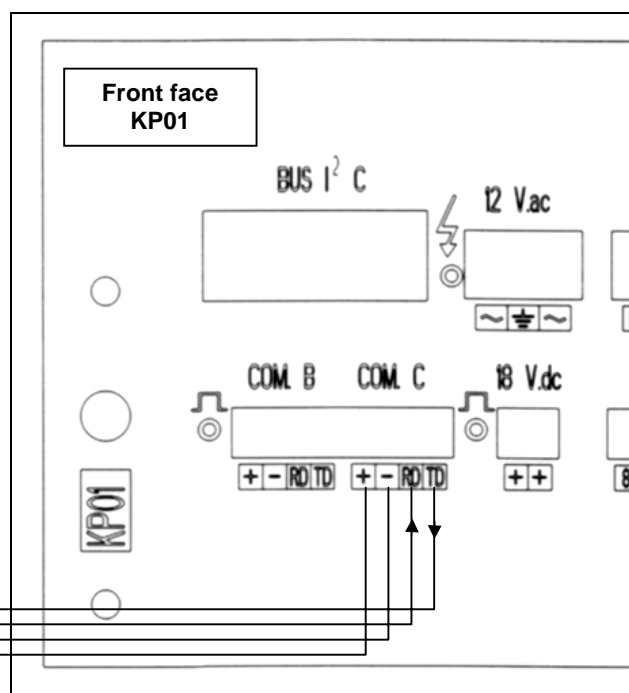
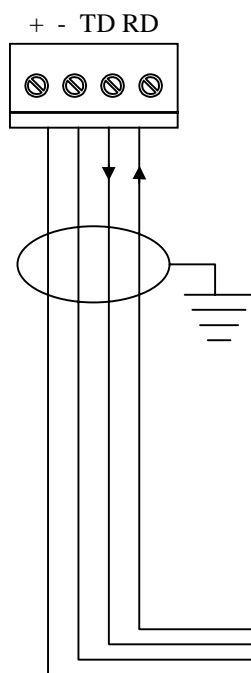
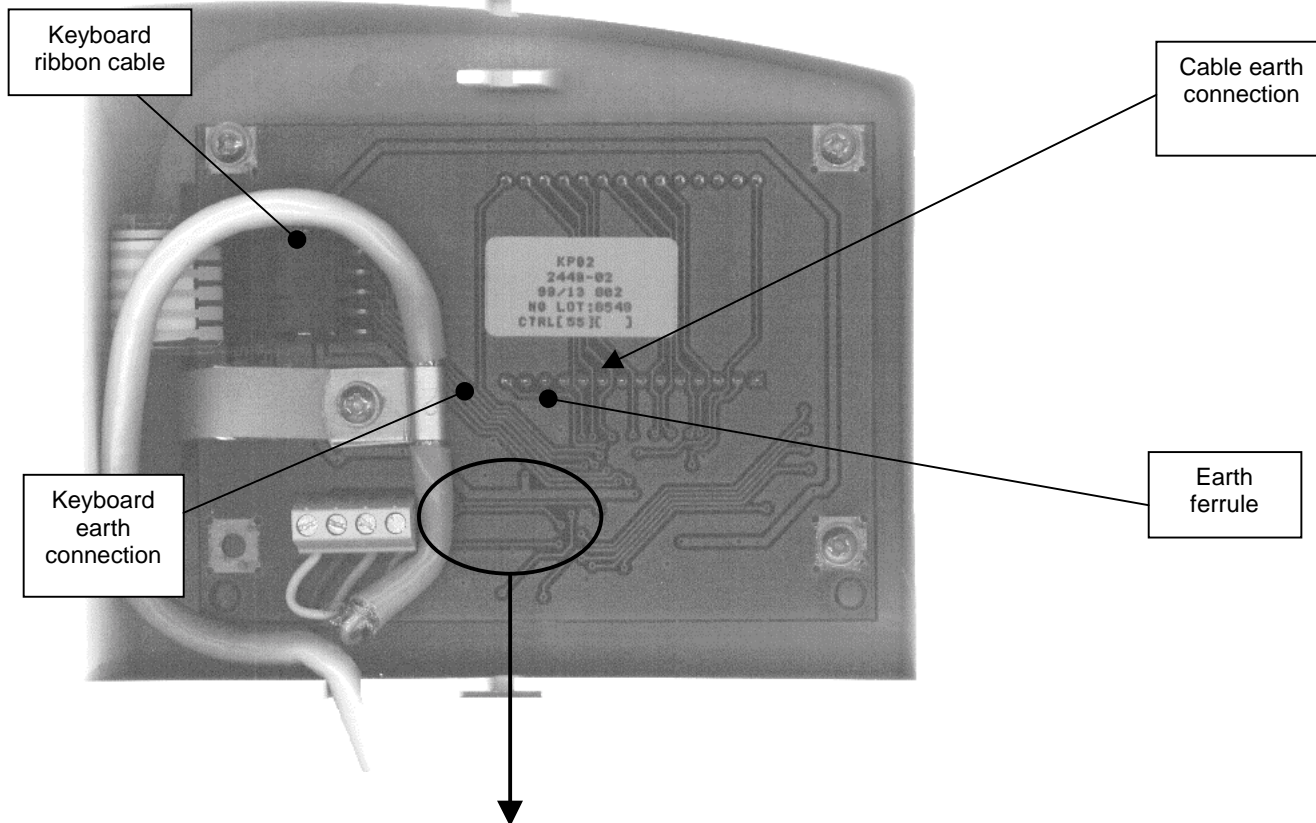
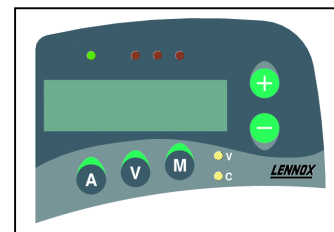

VDU CONSOLE ➤ KP07

1. PRESENTATION

See § I chapter "VDU CONSOLE KP07".

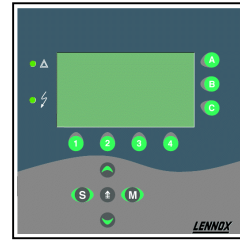

2. CONFIGURATION

☞ Communication port (SW4) and external / internal supply (SW1 & SW2)

The communication port B or C is configured using switch SW4 as shown below:

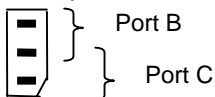

The choice between external or internal supply depends on which KP01 communication port the KP07 display unit is connected to, and its local or remote position in relation to the CPU:

Communication port sur the KP01	B	B	C
Relative position KP07 / KP01	Local	Remote	Local
Type of supply	Internal	External	External

The positions of jumpers SW1 and SW2 to be used, depending on internal or external power supply configuration, are marked on the card. They must both indicate the same type of power supply.

☞ Adjusting contrast (P1)

The potentiometer P1 allows adjustment of screen contrast by default.

3. REPLACEMENT OF A VDU CONSOLE

Procedure to be followed:

- Turn off the supply to the card and change the card.
- Retrieve the EPROM from the old card and the fit it to the new one (see drawing below).

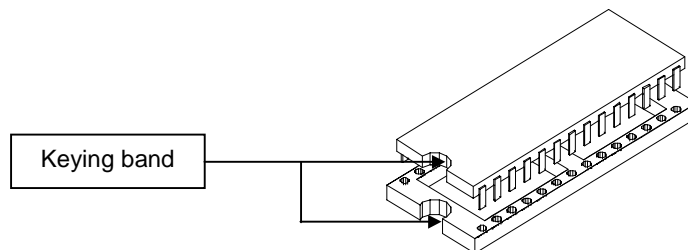

- Reconnect all connections to the KP07, referring to the wiring diagram.

VDU CONSOLE ➤ KP02

4. WIRING

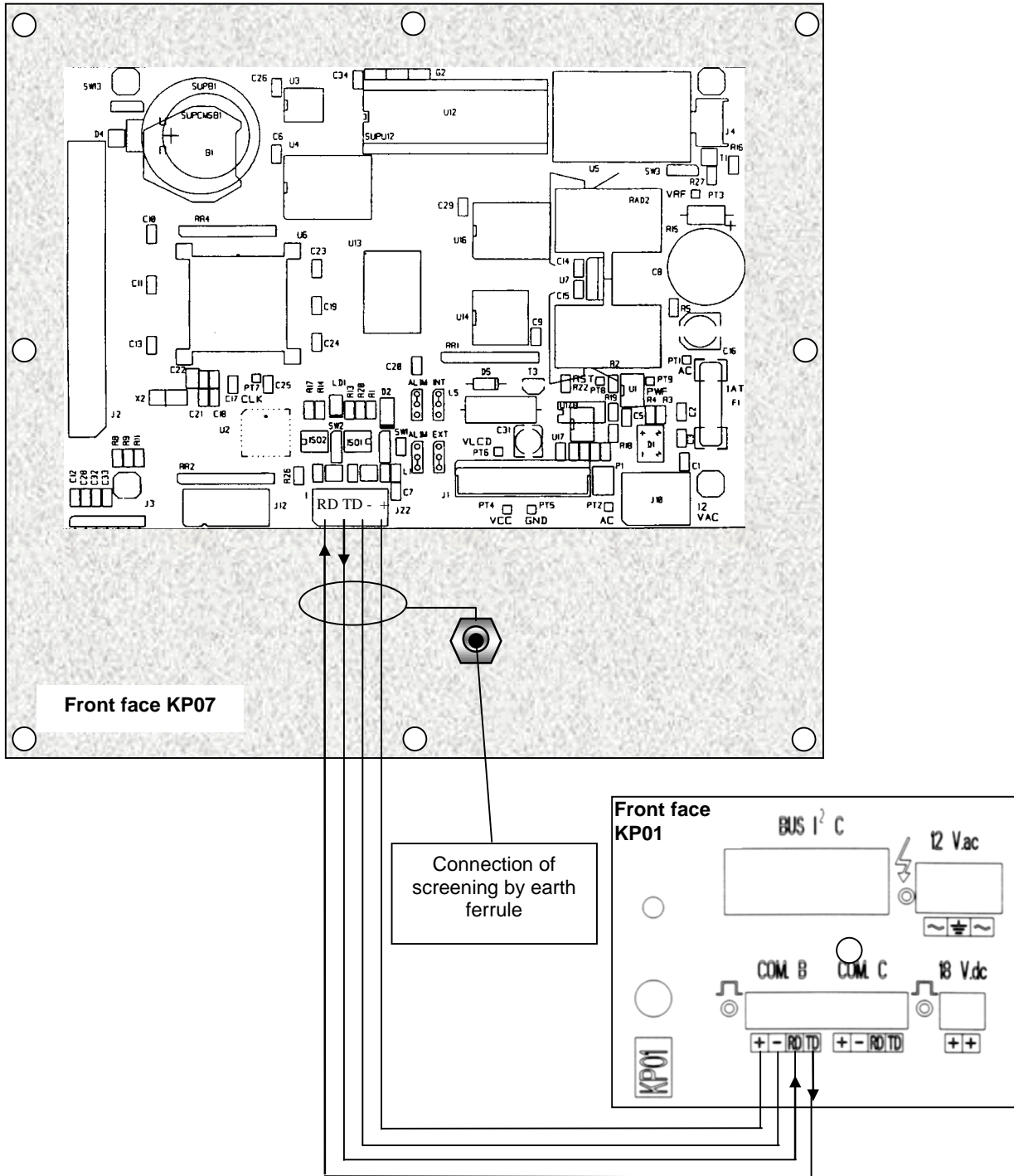

The cable connecting the display unit to the principal unit must be earthed by means of an earth ferrule fixed to the front face using the nut provided for this purpose.

Given the presence of joints between the front face and the console support, and between the support and the door of the electrical cabinet, two bonding jumpers are required to ensure proper electrical contact between these 3 elements.

VDU CONSOLE > kp02

5. CARD DIAGRAM

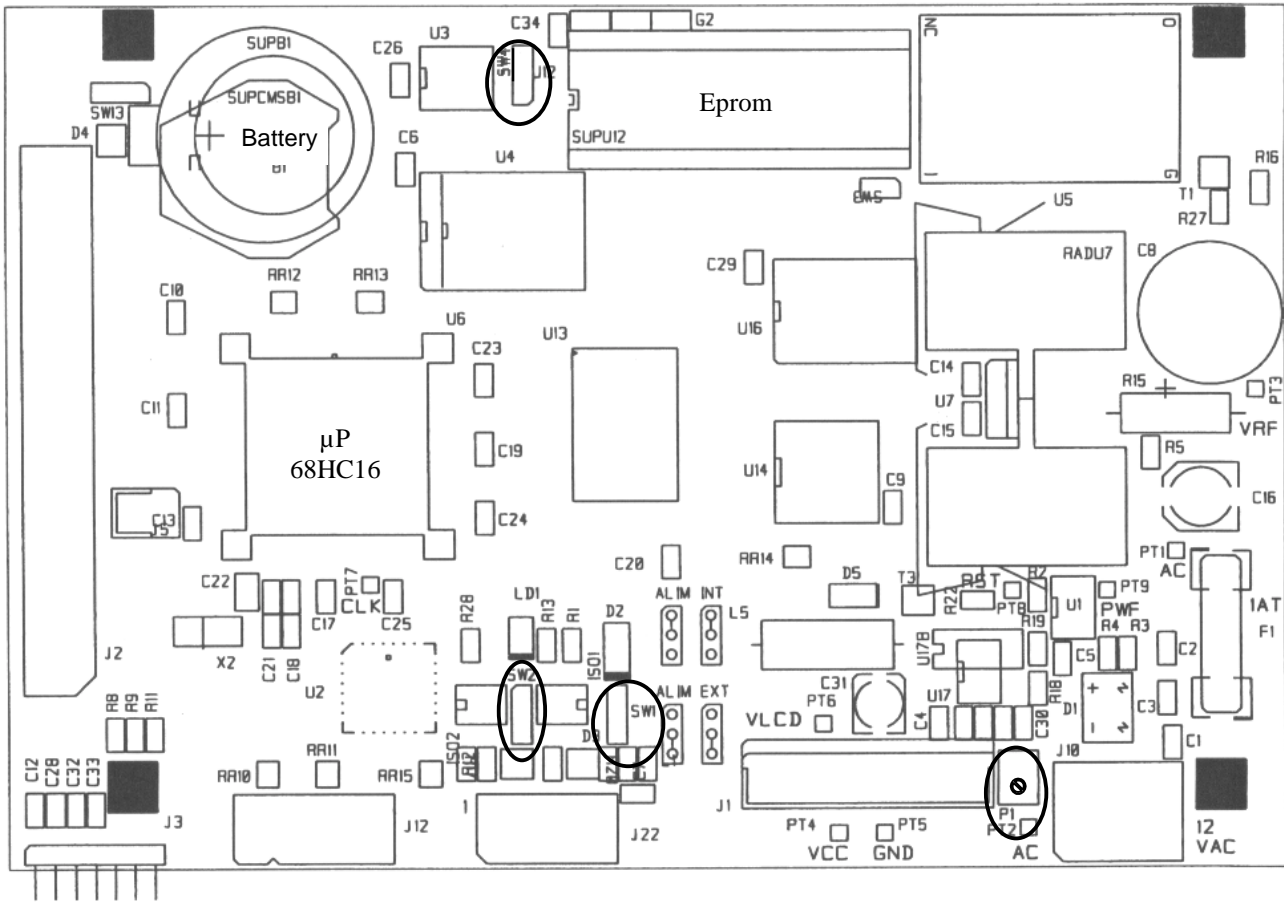

- F1: 1 AT fuse
- J3: Keyboard connector
- J22: Serial link connector
- J10: 12Vac power supply connector
- LD1: Led presence of dialogue
- P1**: Adjustment of screen contrast by default
- PT1, PT2: 12 Vac
- PT3: Vref
- PT4: Vcc
- PT5: Gnd
- PT6: VLcd
- PT8: Reset
- PT9: Power Fail
- SW1**, **SW2**: Power supply configuration switches
- SW4**: Communication port configuration switch (on KP01)

GREAT BRITAIN ,
IRELAND : LENNOX INDUSTRIES LTD
tel. : + 44 1604 599400
fax : + 44 1604 594200
e-mail : marketing@lennoxind.com

BELGIUM : LENNOX BENELUX N.V./S.A.
tel. : + 32 3 633 30 45
fax : + 32 3 633 00 89
e-mail : info.be@lennoxbenelux.com

CZECH REPUBLIC : JANKA RADOTIN AS
tel. : + 420 2 510 88 111
fax : + 420 2 579 10 393
e-mail : janka@janka.cz

FRANCE : LENNOX FRANCE
tel. : + 33 1 60 17 88 88
fax : + 33 1 60 17 86 58
e-mail : accueil@lennoxfrance.com

GERMANY : LENNOX DEUTSCHLAND GmbH
tel. : + 49 69 42 0979 0
fax : + 49 69 42 09 79 40
e-mail : info.de@lennoxdeutschland.com

NETHERLANDS : LENNOX BENELUX B.V.
tel. : + 31 33 2471 800
fax : + 31 33 2459 220
e-mail : info@lennoxbenelux.com

POLAND : LENNOX POLSKA Sp. z o. o.
tel. : + 48 22 832 26 61
fax : + 48 22 832 26 62
e-mail : lennoxpolska@inetia.pl

PORTUGAL : LENNOX CLIMATIZAÇÃO LDA.
tel. : +351 22 999 84 60
fax : +351 22 999 84 68
e-mail : info@lennoxportugal.com

RUSSIA : LENNOX DISTRIBUTION MOSCOW
tel. : + 7 095 246 07 46
fax : + 7 502 933 29 55
e-mail : lennox.dist.moscow@mtu-net.ru

SLOVAKIA : LENNOX SLOVAKIA
tel. : + 421 7 44 87 19 27
fax : + 421 7 44 88 64 72

SPAIN : LENNOX REFAC S.A.
tél. : + 34 902 400 405
fax : + 34 91 542 84 04
e-mail : marketing@lennox-refac.com

UKRAINE : LENNOX DISTRIBUTION KIEV
tel. : + 380 44 213 14 21
fax : + 380 44 213 14 21
e-mail : jankauk@uct.kiev.ua

OTHER EUROPEAN COUNTRIES,
AFRICA,
MIDDLE-EAST : LENNOX DISTRIBUTION
tel. : + 33 4 72 23 20 14
fax : + 33 4 72 23 20 28
e-mail : marketing@lennoxdist.com



LENNOX[®]

www.Lennox.com