

3X380V ~ 50HZ+III+PE
67 KVA

1CM1
I_{max} = 53 Amp
I_{nom} = 41,5 Amp

2CM1
I_{max} = 53 Amp
I_{nom} = 41,5 Amp

SI = STANDAARD
LI = LOW NOISE
WR = WILTERREGELING
UL = UITLEZER

REVUE	REVUE	REVUE	REVUE
DATE 15-11-1992	SUBJECT	DATE	SUBJECT
JVS	AT400-ST/LN- (MR) - (UL)		
Stork Refac B.V.		RBBG	
DRG NR 106092040	SHEET 01	<i>gec. 9/16/93</i>	

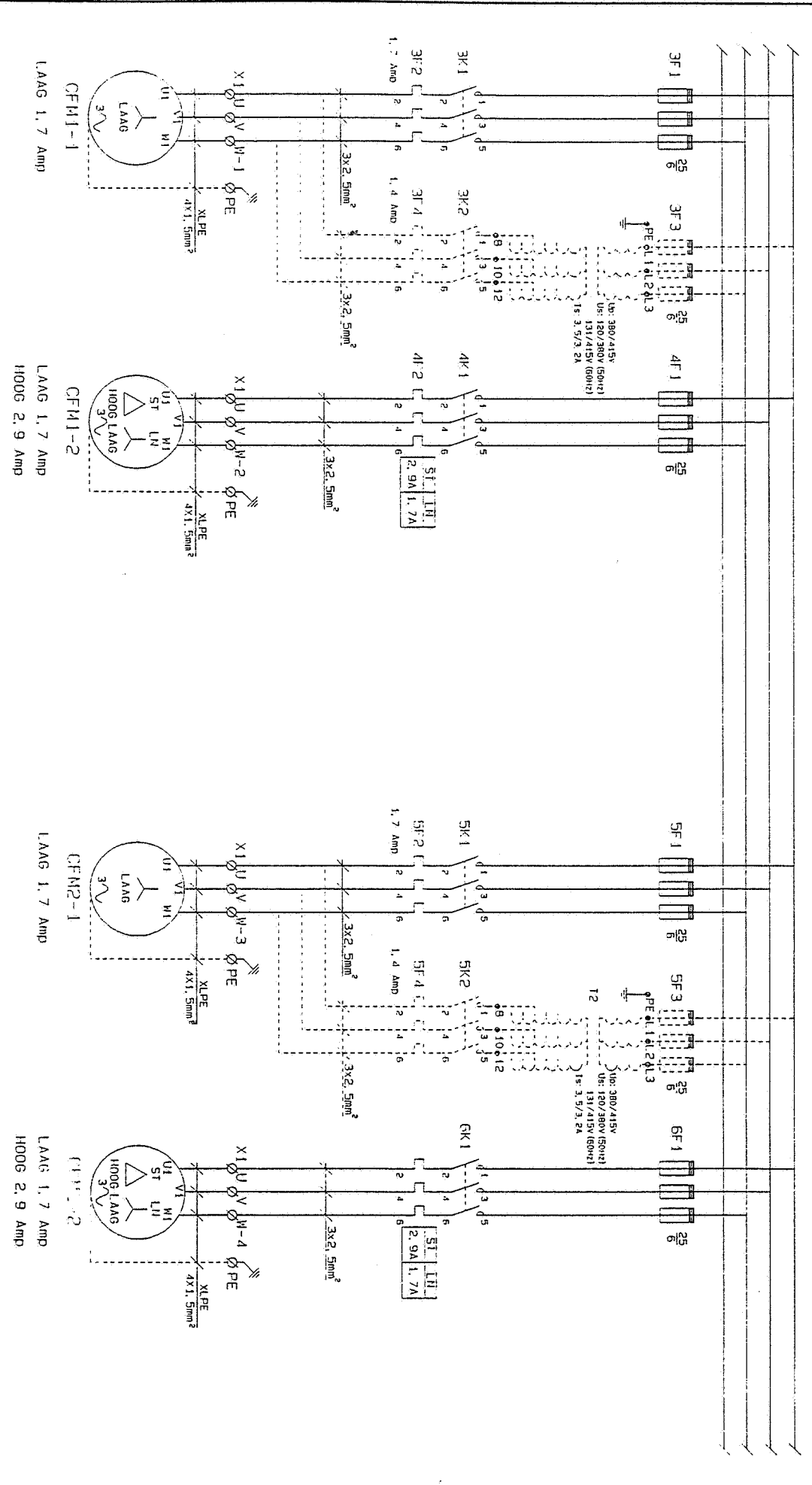

AANSLUITDOOS CFM

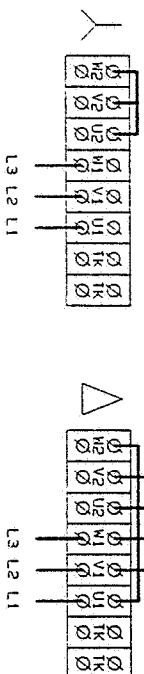

REVDAT: 15-11-1992

REVLIN: JVS

SUBJECT: AT40D-ST/LN-(NR) - (UL)

Stork Refac B.V.

106092010

02

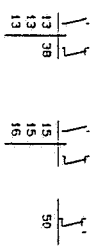
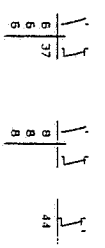
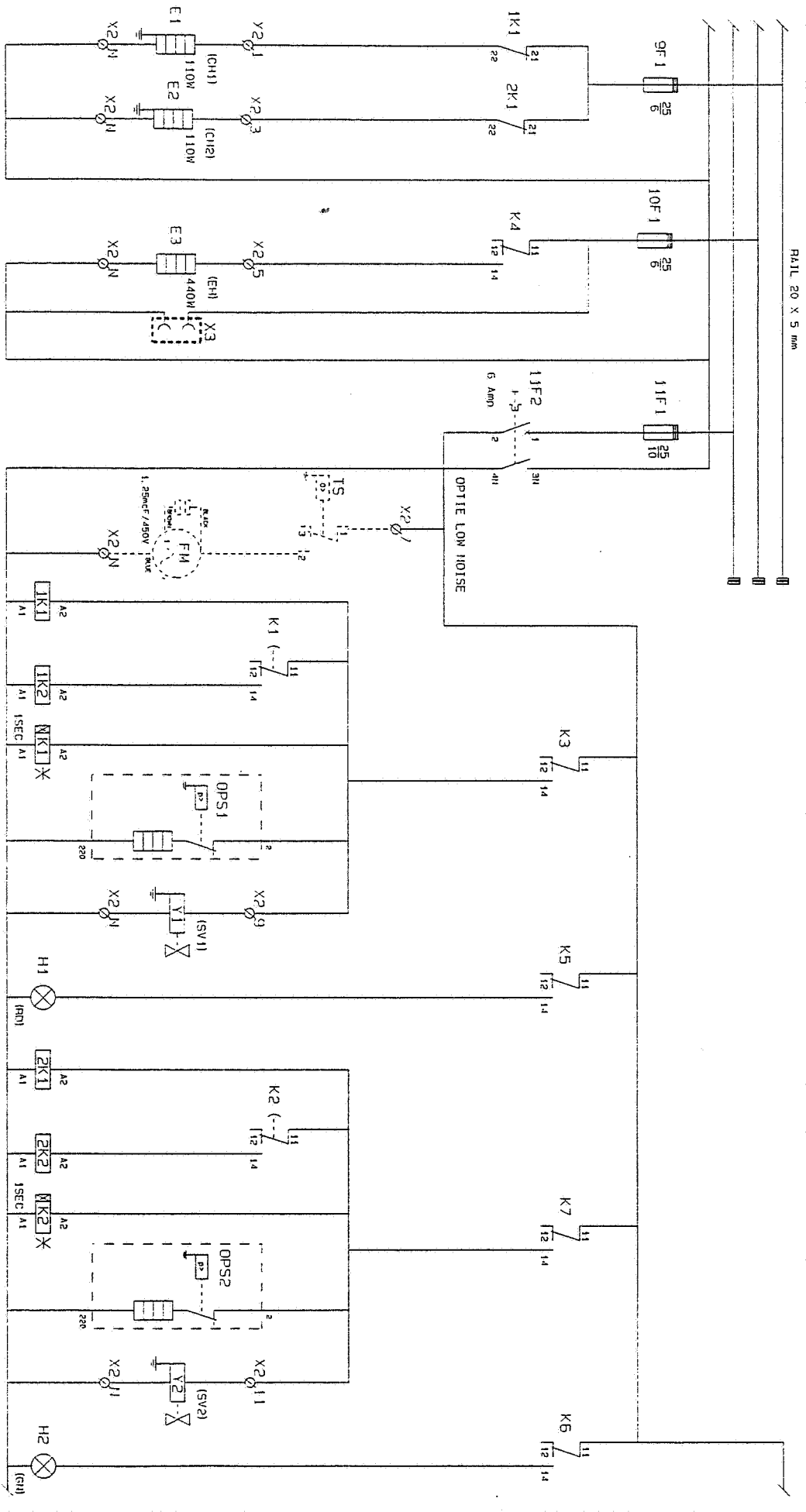

* K1-K2 - CH 1-3M-220VAC/E
 CH 1-2-240-50/60Hz
 ON OFF
 FUNCTION 1 2 3 4
 TIME

REVDATE 06-05-1993	REVLIN A	REVDATE 05-07-1993	REVLIN B	REVDATE	REVLIN
DATE 16-11-1992	SUBJECT	DATE	SUBJECT	DATE	SUBJECT
DR JVS	AT400-ST/LN- (WR) - (UL)	DR	106092040	SHEET	03
Stork Refac B.V.					
REBBI					

Rev. 16-11-93

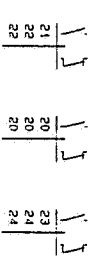
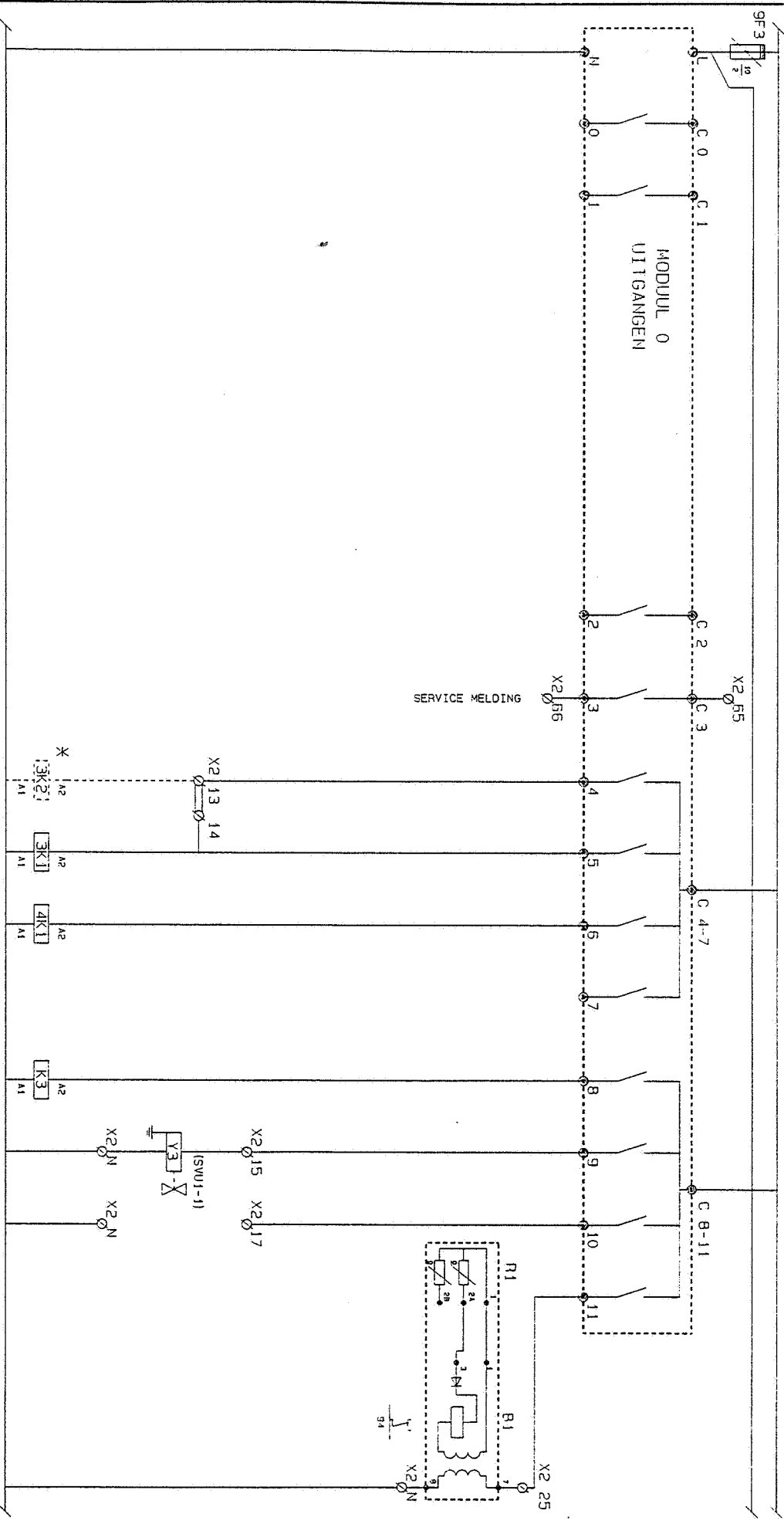

* BIJ MINTERREGELING MAGNEETSCHAKELAAR 3K2 HOËTEREIJ EN DE DOORVERBINDING TUSSEN KLEIN 13 EN 14 VERWIJDEREN.

REVDATE 07-05-1993	REV/LIN A	REVDATE 05-07-1993	REV/LIN B	REVDATE
DATE 16-11-1992	SUBJECT	AT 400-ST/LN- (NR) - (UL)	ORDER	REV/LIN
DR JVS				DRG NR 1060920/40
Stork Refac B.V.				SHEET 04

Rev. A. 17.93

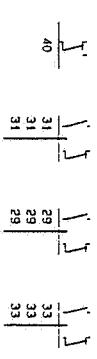
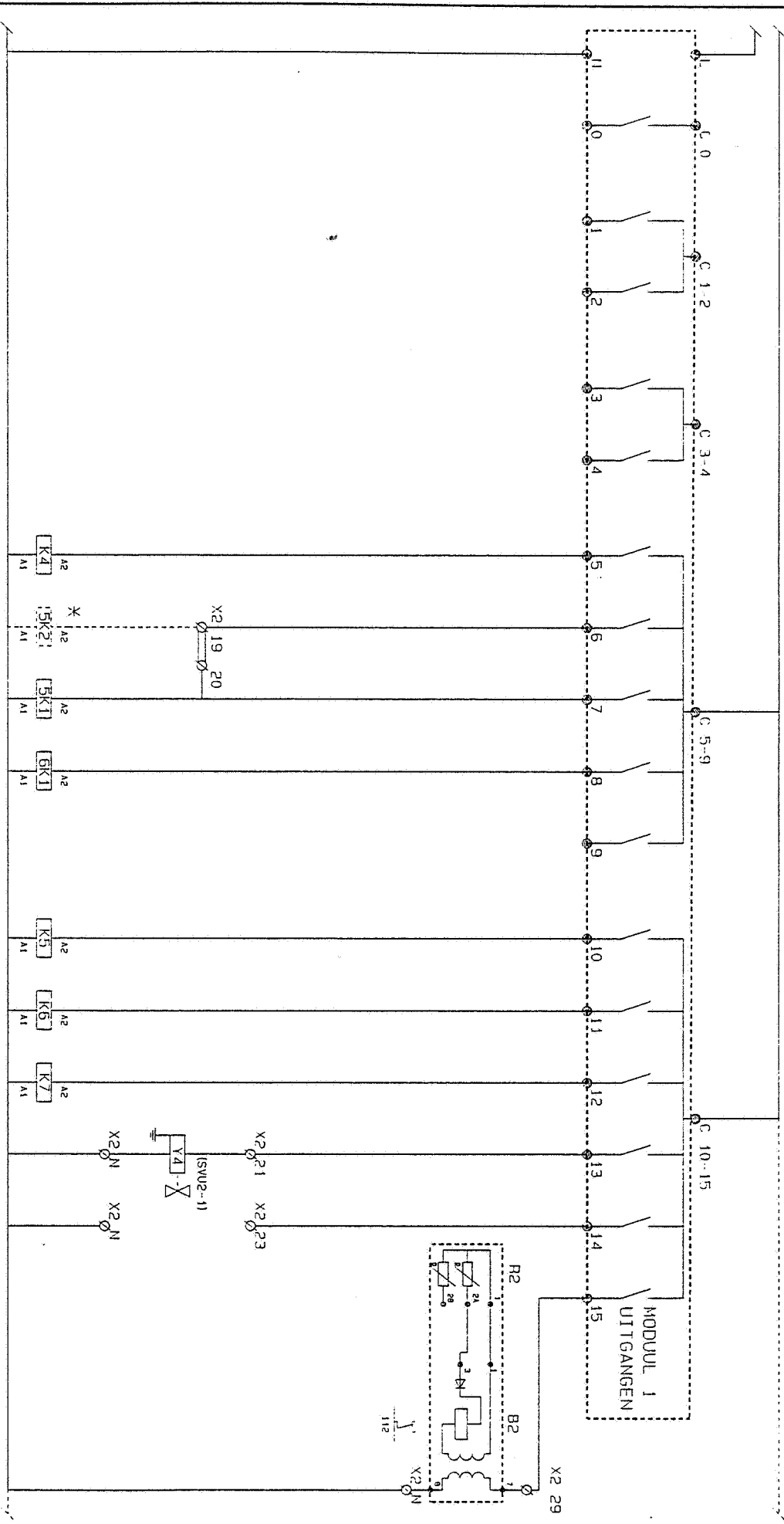

* BIJ NUTTEREGELING MAGNETISCHAKEL AAR SK2 MONTEREN
 EN DE DOORVERBINDING TUSSEN KLEIN 19 EN 20 VERWIJDEREN.

REVDATE 07-05-1993	REVLIN A	REVDATE 05-07-1993	REVLIN B	REVDATE	REVLIN
DATE 16-11-1992	SUBJECT	AT40D-ST/LN- (NR) - (JUL)	ORDER		
DR JVS					
Stork Refac B.V.			106092010	SHEET	05

REBAG

912 11.08.93

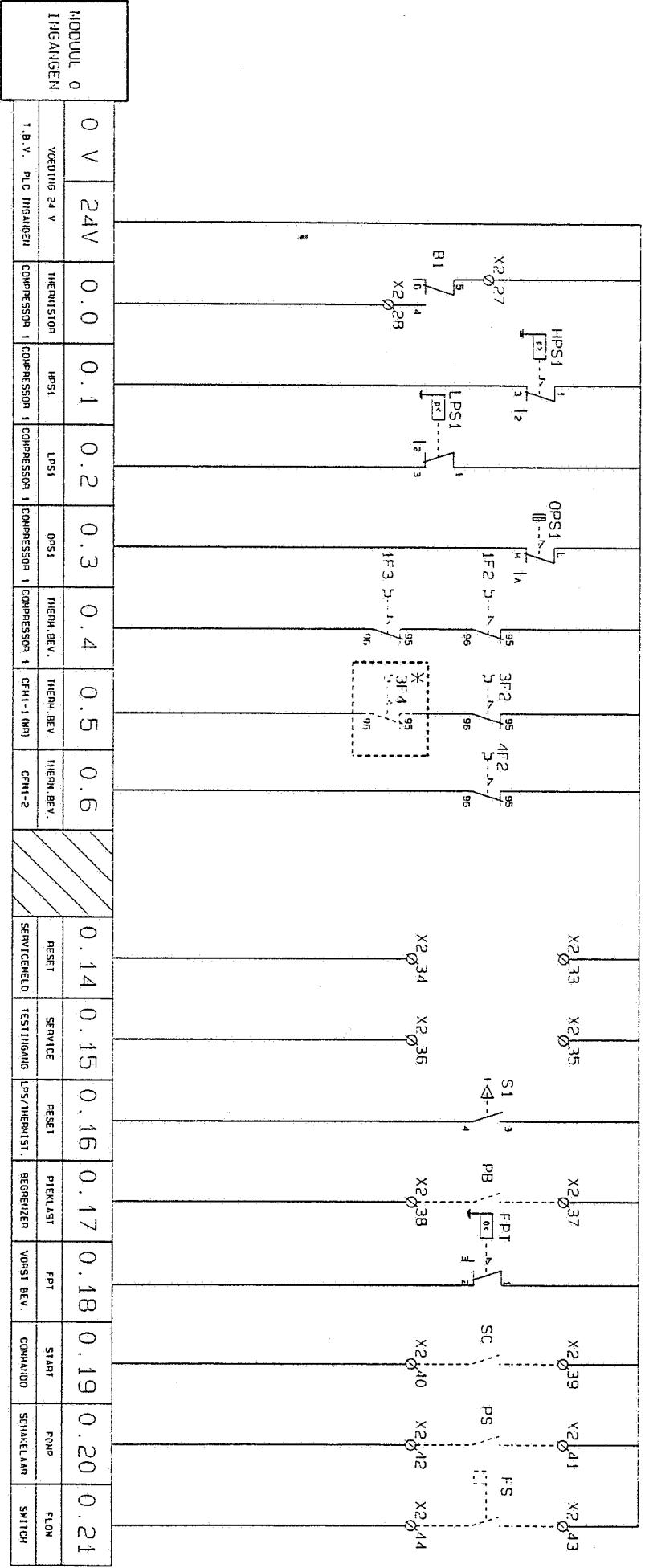

MODUL 0 INGANGEN	
0 V	24V
VEEDING 24 V	
1.8. V. PLC INGANGEN	

0.0	0.1	0.2	0.3	0.4	0.5	0.6		0.14	0.15	0.16	0.17	0.18	0.19	0.20	0.21
TIERNISTION	HPS1	LPS1	OPS1	TIERN. BEV.	TIERN. BEV.	TIERN. BEV.		RESET	SERVICE	RESET	PIEKLAST	FPT	START	STOP	FLUSH
COMPRESSOR 1	COMPRESSOR 1	COMPRESSOR 1	COMPRESSOR 1	COMPRESSOR 1	COMPRESSOR 1	COMPRESSOR 1		SERVICEELD	TESTHIDANG	PS/TIERNIST.	BEGRUIZEN	YORST BEV.	COMANDO	SCHAKELLAAN	SWITCH

REVOLVIE	05-07-1993	REVULIR	A	REVOLVIE	REVULIR	REVOLVIE	REVULIR	
DATE	16-11-1992	SUBJECT	A1400-ST/LN- (WR) - (UL)				ORDE	
OR	JVS							
Stork Refac B.V.							ORDE NR	106092040
							SHEET	06

* OPTIE WINTERREGELING

92. 11. 92

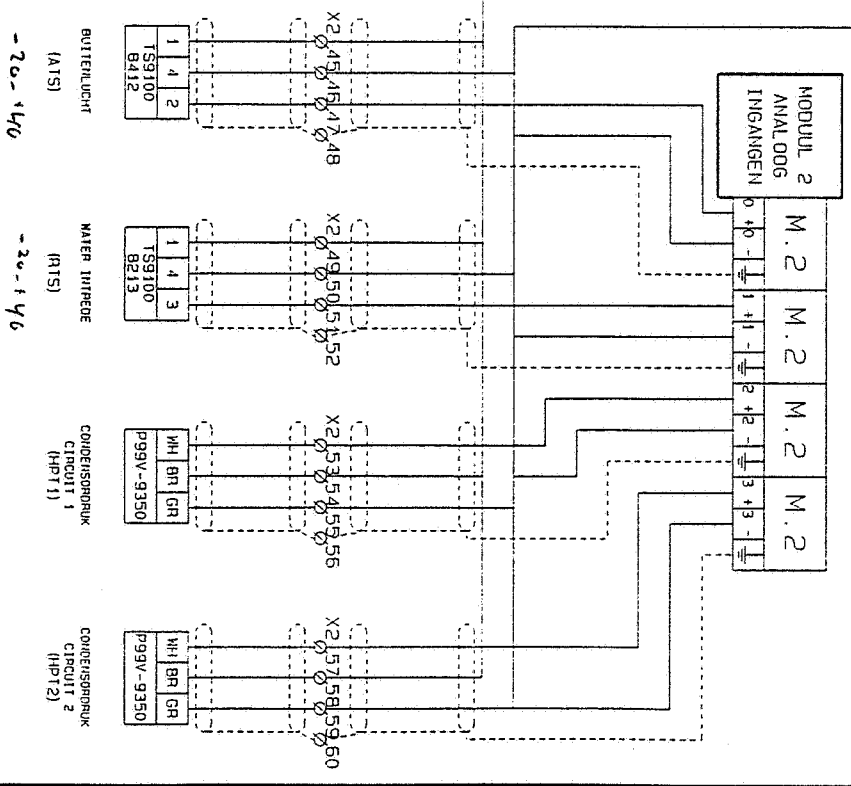
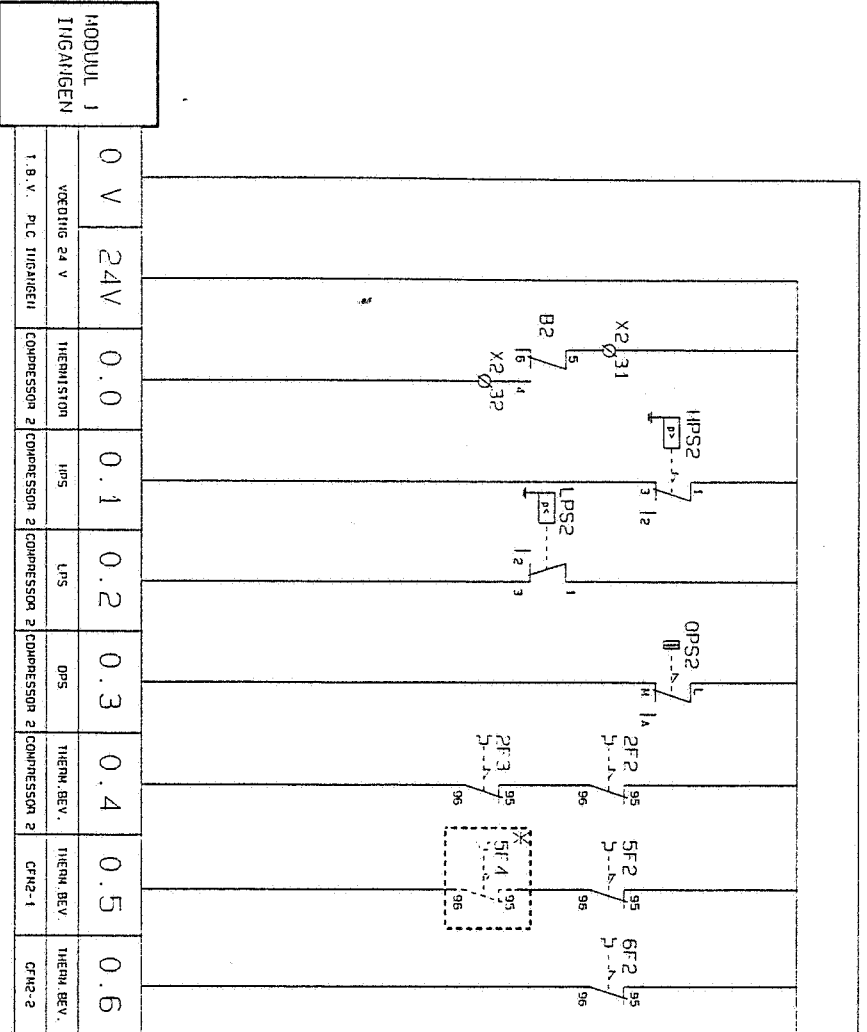

6 pins left

902 11/6/93

* OPTIE MITERREGELING

REVDATE 05-07-1993	REVLIN A	REVDATE	REVLIN	REVDATE	REVLIN
DATE 16-11-1992	SUBJECT	AT40D-ST/LN- (MR) - (UL)	OR	JVS	
Stork Refac B.V.			DRG NR	106092040	SHEET 07

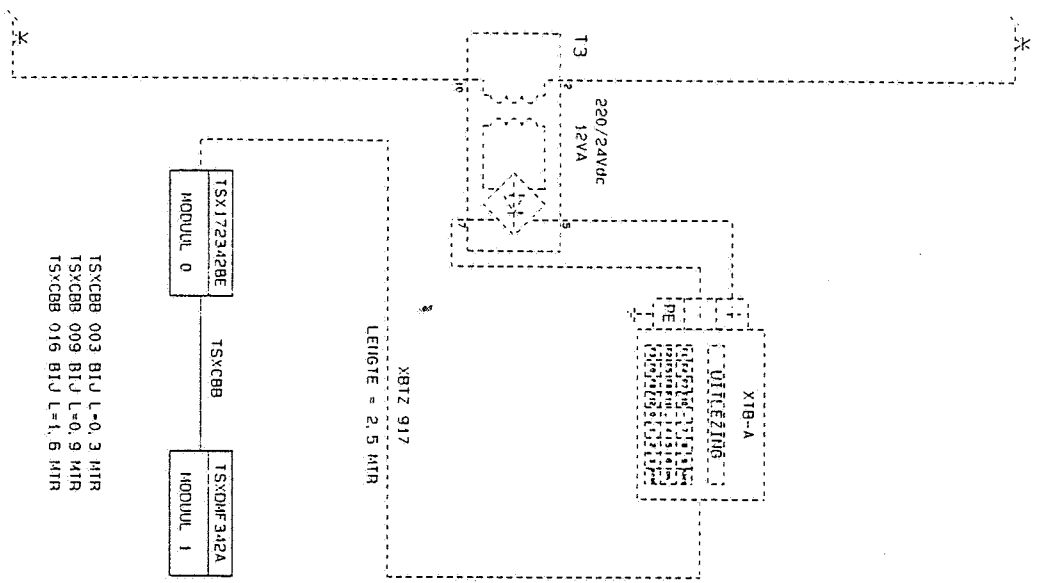

OPTIE UITLEZER

- [F1] = Conditie menu
- [F2] = Meldingen doorlopen
- [F3] = Koelmachine starten
- [F4] = Terug naar het hoofdmenu
- [F5] = Melding vasthouden
- [F6] = Koelmachine stoppen
- [F12] = I.D code (E)
- Functie 70 ENTER = Selecteer teststand
- Functie 71 ENTER = Reset teststand
- Functie 90 ENTER = Reset lage druk / thermistor-storing
- Functie 91 ENTER = Reset service melding
- Functie 92 ENTER = Setpoint verstelling (E)

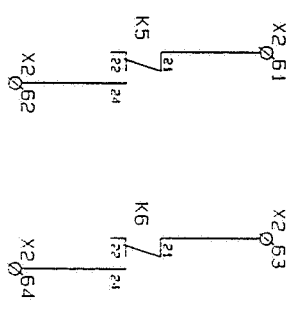
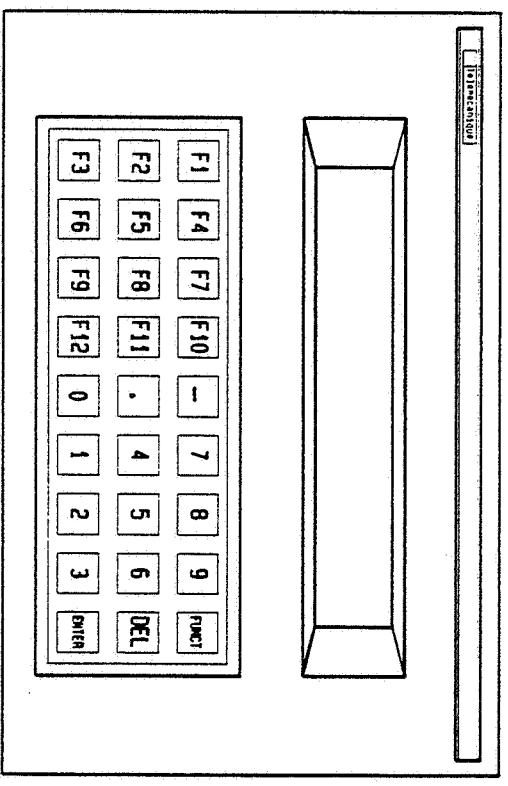

CONTINU = STORING KOELMACHINE
 PULS = EXTERN GEBLOKKEERD

CONTINU = BEDRIJF
 PULS = INTERN GEBLOKKEERD

* OPTIE UITLEZER

REVDATE 06-05-1993	REV.LIN. A	REVDATE	REV.LIN.	REVDATE	REV.LIN.
DATE 16-11-1992	SUBJECT	A40D-ST/LN-(WR) - (UL)		ORDER	
DN JVS	Stork Refac B.V.				DNG IFR 106092040
ORSTOR					SHEET 08

22. 11. 93

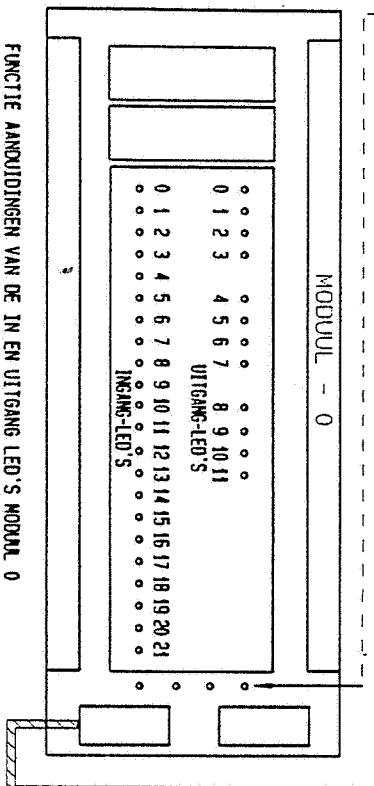
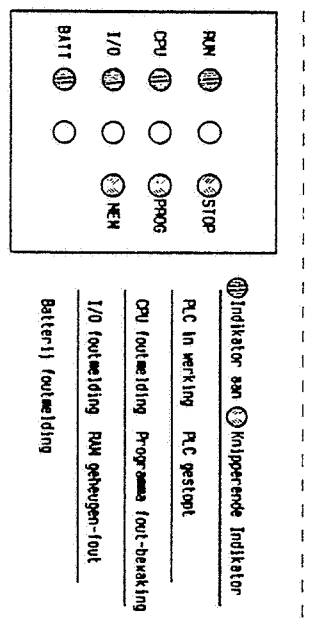

NET-SPANNING UITSCHAKELEN INDIEN HANDELIJNGEN AAN DE PLC KORBEN VERBODEN!

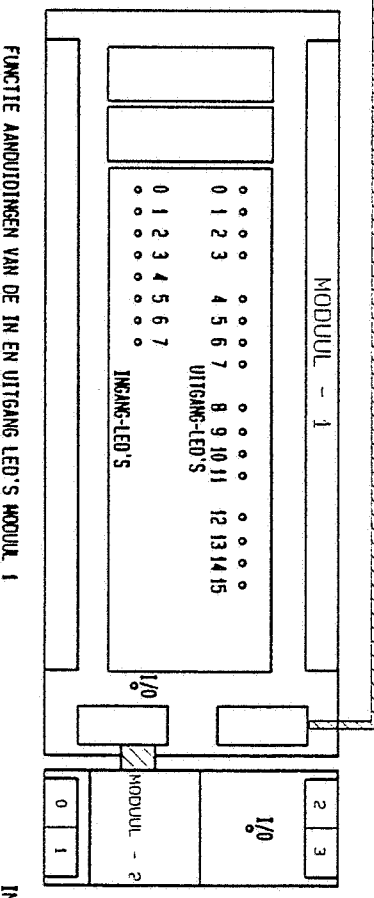

- FUNCTIE AANDUIDINGEN VAN DE IN EN UITGANG LED'S MODUUL 0
- | NR. FUNCTIE | INGANG LED'S | NR. FUNCTIE | UITGANG LED'S |
|-------------|--------------|-------------|---------------|
| 0 | 0 | 0 | 0 |
| 1 | 1 | 1 | 1 |
| 2 | 2 | 2 | 2 |
| 3 | 3 | 3 | 3 |
| 4 | 4 | 4 | 4 |
| 5 | 5 | 5 | 5 |
| 6 | 6 | 6 | 6 |
| 7 | 7 | 7 | 7 |
| 8 | 8 | 8 | 8 |
| 9 | 9 | 9 | 9 |
| 10 | 10 | 10 | 10 |
| 11 | 11 | 11 | 11 |

- FUNCTIE AANDUIDINGEN VAN DE IN EN UITGANG LED'S MODUUL 1
- | NR. FUNCTIE | INGANG LED'S | NR. FUNCTIE | UITGANG LED'S | NR. FUNCTIE | INGANGEN VAN MODUUL 2 |
|-------------|--------------|-------------|---------------|-------------|-----------------------|
| 0 | 0 | 0 | 0 | 0 | 0 |
| 1 | 1 | 1 | 1 | 1 | 1 |
| 2 | 2 | 2 | 2 | 2 | 2 |
| 3 | 3 | 3 | 3 | 3 | 3 |
| 4 | 4 | 4 | 4 | 4 | 4 |
| 5 | 5 | 5 | 5 | 5 | 5 |
| 6 | 6 | 6 | 6 | 6 | 6 |
| 7 | 7 | 7 | 7 | 7 | 7 |
| 8 | 8 | 8 | 8 | 8 | 8 |
| 9 | 9 | 9 | 9 | 9 | 9 |
| 10 | 10 | 10 | 10 | 10 | 10 |
| 11 | 11 | 11 | 11 | 11 | 11 |
| 12 | 12 | 12 | 12 | 12 | 12 |
| 13 | 13 | 13 | 13 | 13 | 13 |
| 14 | 14 | 14 | 14 | 14 | 14 |
| 15 | 15 | 15 | 15 | 15 | 15 |

REVISIE 05-07-1993

DATE 16-11-1992

REV. A REV. B REV. C REV. D REV. E

SUBJECT AT400-ST/LN- (WR) - (UL)

DWG NR 106092040

SHEET 09

Stork Refac B.V.

gpc 14.11.93

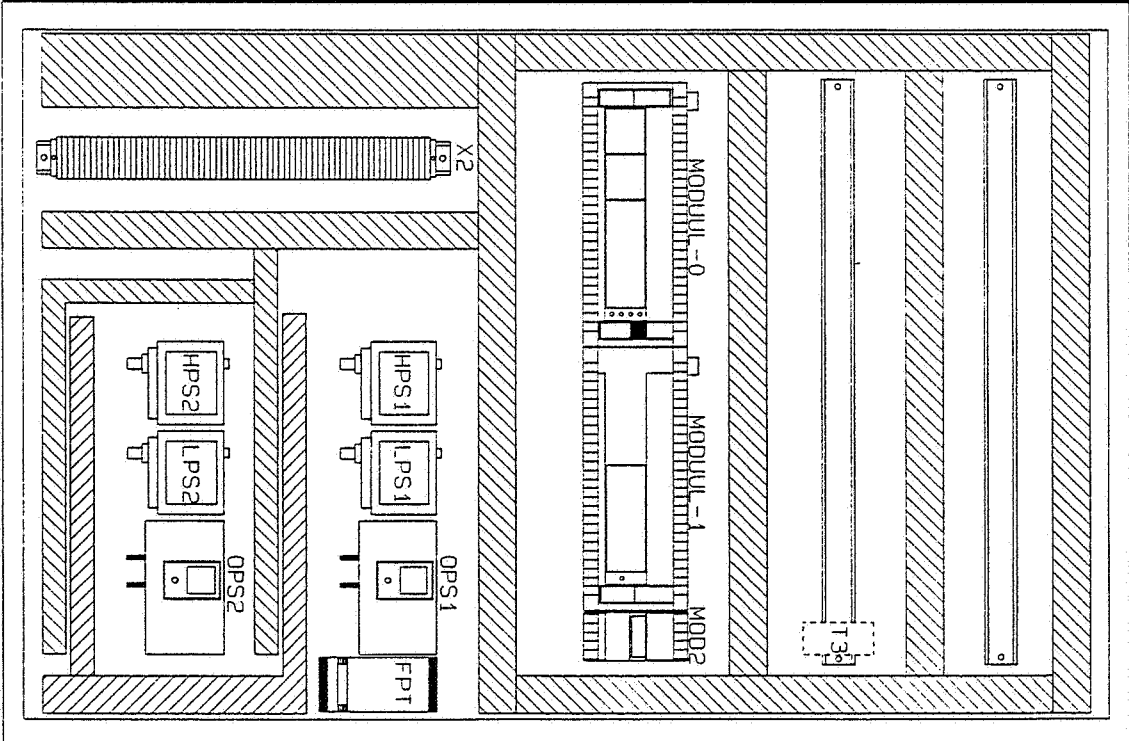
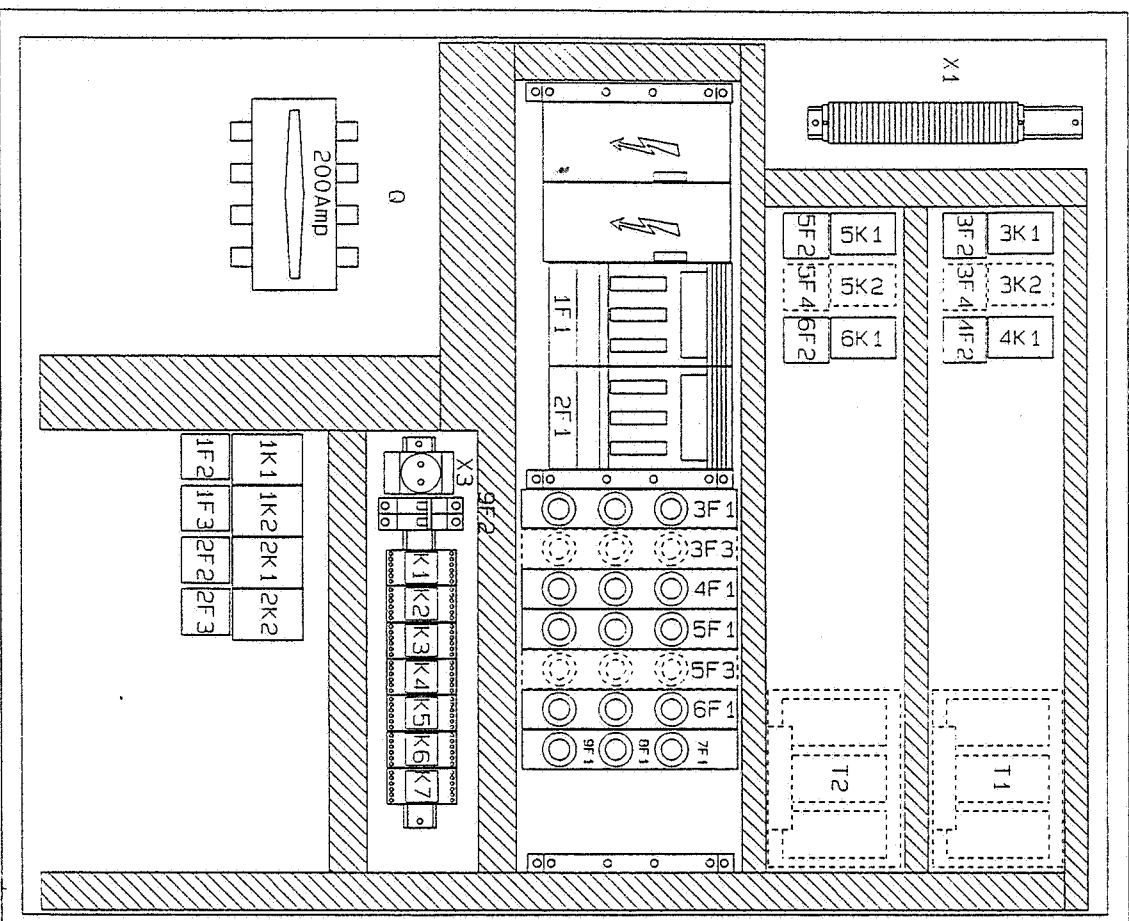

REVDATE	REV. IN	REVDATE	REV. IN	REVDATE	REV. IN
DATE	SUBJECT	DATE	SUBJECT	DATE	SUBJECT
16-11-1992	JVS	AT40D-ST/LN- (NR) - (UL)			
DR	Stork Refac B.V.			DRG NR	106092040
	PBB			SHEET	10

901. 20. 6. 93

181 182 183 184 185 186 187 188 189 190 191 192 193 194 195 196 197 198

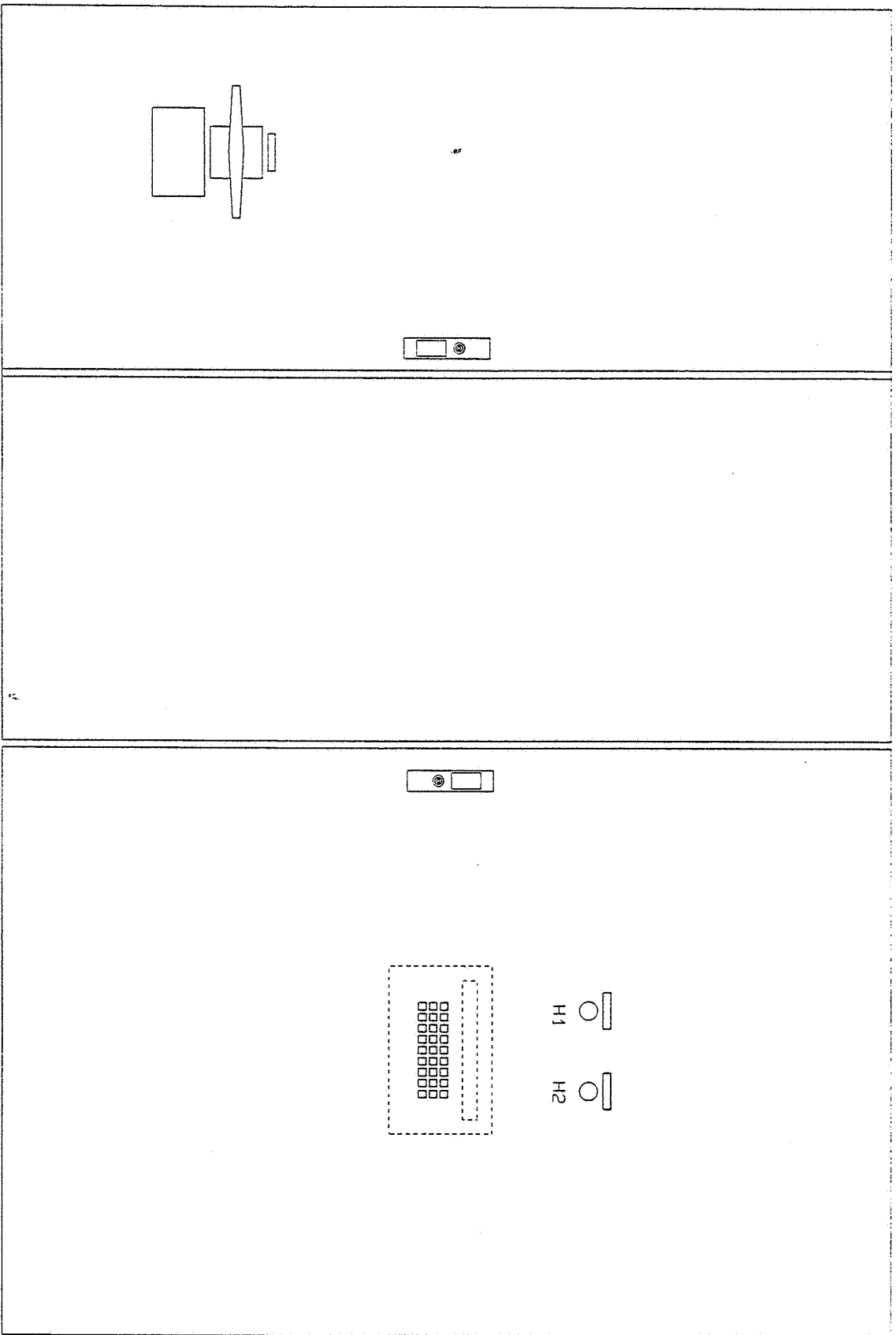

REVDATE	REV IN	REVDATE	REV IN	REVDATE	REV IN	SHEET
16-11-1992						11
DATE	SUBJECT	DATE	SUBJECT	DATE	SUBJECT	
16-11-1992	AT140D-ST/LN- (MR) - (UL)					
DR	JVS					
Stork Refac B.V.			106092040			
199373						

Rev. 16/11/92

Code	Omschr j/ving	Fabr/kaat	Type	Code	Omschr j/ving	Fabr/kaat	Type
0	Hoofd schakelaar		Dumeco S 32c/4	K1	Relais	Sprecher en Schuh	CH1-3W-220Vac/E
1F1	Hespatroonhouder	Rittai	SV 3401		Tijdmoduul	Sprecher en Schuh	CH1-Z-240V-50/60Hz
2F1	Hespatroonhouder	Rittai	SV 3401	K2	Relais	Sprecher en Schuh	CH1-3W-220Vac/E
3F1	Zekeringshouder	Rittai	SV3427 + SV2428		Tijdmoduul	Sprecher en Schuh	CH1-Z-240V-50/60Hz
3F3	Zekeringshouder	Rittai	SV3427 + SV2428 (WR)	K3	Relais	Sprecher en Schuh	CH1-3W-220Vac/E
4F1	Zekeringshouder	Rittai	SV3427 + SV2428	K4	Relais	Sprecher en Schuh	CH1-3W-220Vac/E
5F1	Zekeringshouder	Rittai	SV3427 + SV2428	K5	Relais	Sprecher en Schuh	CH1-3W-220Vac/E
5F3	Zekeringshouder	Rittai	SV3427 + SV2428 (WR)	K6	Relais	Sprecher en Schuh	CH1-3W-220Vac/E
6F1	Zekeringshouder	Rittai	SV3427 + SV2428	K7	Relais	Sprecher en Schuh	CH1-3W-220Vac/E
7-9F1	Zekeringshouder	Rittai	SV3427 + SV2428	H1	Relais	Sprecher en Schuh	DEL03-R-B-E
9F2	Instalatieautomat	A.B.B.	S251-L 60A	H2	Sigmaamp	Sprecher en Schuh	DEL03-R-B-E
9F3	Zekeringskleem		VUS1 4-10 H	X3	Sigmaamp	Sprecher en Schuh	DEL03-R-B-E
1K1	Magneetschakelaar		CA3-60-220V50-11	X3	Wandcontactdoos	Sprecher en Schuh	WDR 2
1K2	Magneetschakelaar		CA3-60-220V50-11	T1	3-fasen regelrato	Sprecher en Schuh	FOR 3.5/3 (WR)
2K1	Magneetschakelaar		CA3-60-220V50-11	T2	3-fasen regelrato	Sprecher en Schuh	FDR 3.5/3 (WR)
2K2	Magneetschakelaar		CA3-60-220V50-11	T3	Opsteek voeding	Sprecher en Schuh	SS120230 (UL)
3K1	Magneetschakelaar		CA3-09-220V50-10	FPT	Vorstthermostaat	Sprecher en Schuh	A19ACC-9116
3K2	Magneetschakelaar		CA3-09-220V50-10 (WR)	OPS1	Olieoliff. dressostaat	Sprecher en Schuh	P45HBB-9680C
4K1	Magneetschakelaar		CA3-09-220V50-10	OPS2	Olieoliff. dressostaat	Sprecher en Schuh	P45HBB-9680C
5K1	Magneetschakelaar		CA3-09-220V50-10	HPS1	Hogedruk pressostaat	Sprecher en Schuh	P77BEA-9350
5K2	Magneetschakelaar		CA3-09-220V50-10 (WR)	HPS2	Hogedruk pressostaat	Sprecher en Schuh	P77BEA-9350
6K1	Magneetschakelaar		CA3-09-220V50-10	LPS1	Lagedruk pressostaat	Sprecher en Schuh	P77AAA-9300
1F2	Thermisch relais		CT3-52-52A	LPS2	Lagedruk pressostaat	Sprecher en Schuh	P77AAA-9300
1F3	Thermisch relais		CT3-52-52A	ATS	Temp. drijmer buitenlicht	Sprecher en Schuh	TS9100-8412
2F2	Thermisch relais		CT3-52-52A	RIS	Temp. opnemer waterintrede	Sprecher en Schuh	TS9100-8213
2F3	Thermisch relais		CT3-52-52A	HP11	Drukopnemer circ. 1	Sprecher en Schuh	P99V-9350
3F2	Thermisch relais		CT3-12-2.5A	HP12	Drukopnemer circ. 2	Sprecher en Schuh	P99V-9350
3F4	Thermisch relais		CT3-12-1.6A (WR)	M-0	P.L.C.	Sprecher en Schuh	TSX 172428E
4F2	Thermisch relais		CT3-12-4.0A	H-1	Uitbreidingsblok	Sprecher en Schuh	TSX DWF 242A
5F2	Thermisch relais		CT3-12-2.5A (LH)	H-2	Analoog moduul	Sprecher en Schuh	TSX AEG 4110
5F4	Thermisch relais		CT3-12-1.6A (WR)	TS	Thermostaat (FH)	Sprecher en Schuh	A199RC-9251 (LH)
6F2	Thermisch relais		CT3-12-4.0A	FH	Fan motor	Sprecher en Schuh	RN146F940.04 (LH)

REVDATE	REVDATE	REVDATE	REVDATE
DATE 16-11-1992	REVDATE	REVDATE	REVDATE
DR JVS	SUBJECT	DR	SHEET
	AT140D-ST/LN- (WR) - (UL)	DRG NR 106092040	12

Stork Refac B.V. **REFAC**

Rev. 1.1. 6/9.93

