

5 10 15 20 25 30 35 40 45 50 55 60 65 70 75 80 85 90 95 100

INDICE	
REGLETERO CONEXIONES ELECTRICAS TERMINAL STRIP BORNIER DE CONNEXION ELECTRIQUE KLEMMLEISTE	HOJA 1/5
CIRCUITO POTENCIA POWER CIRCUIT CIRCUIT DE PUISSANCE STROMKREIS	HOJA 2/5
CIRCUITO MANIOBRA CONTROL CIRCUIT CIRCUIT DE CONTROL STUEERKREIS	HOJA 3/5
CONEXION OPCIONALES OPTIONS CONNEXIONS OPTIONNELS OPTIONEN / ZUBEHÖR	HOJA 4/5
LEYENDA REFERENCIAS REFERENCES LEGEND REFERENCE DE LEGENDE LEGENDE	HOJA 5/5



ESQUEMA ELECTRICO
WIRING DIAGRAM
SCHEMA ELECTRIQUE
SCHALTPLAN

Elemento Opcional Optional Element Element optionnel Optiondes bauteil	-----	A realizar por el instalador To wire by the installer A câbler par l'installateur Verdrahtung durch den Installateur	-----	0/5	Lennox Refoc S.A.	ESQUEMA ELECTRICO ELECTRIC DIAGRAM	FMH 15-20-25-30 (FIH+FSH)	4Z-33-383-311 43N 3N ~400V 50HZ + PE
---	-------	---	-------	------------	-------------------	---------------------------------------	--------------------------------------	---

5 10 15 20 25 30 35 40 45 50 55 60 65 70 75 80 85 90 95 100

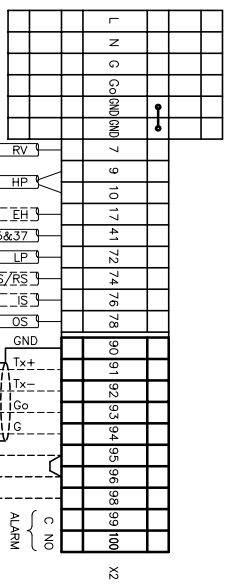
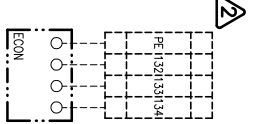

ON/OFF REMOTO
REMOTE ON/OFF
FRIO/CALOR
COOL/HEAT

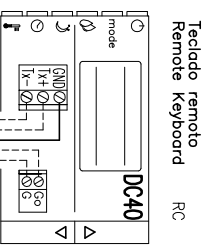
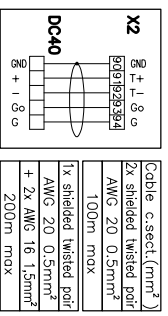
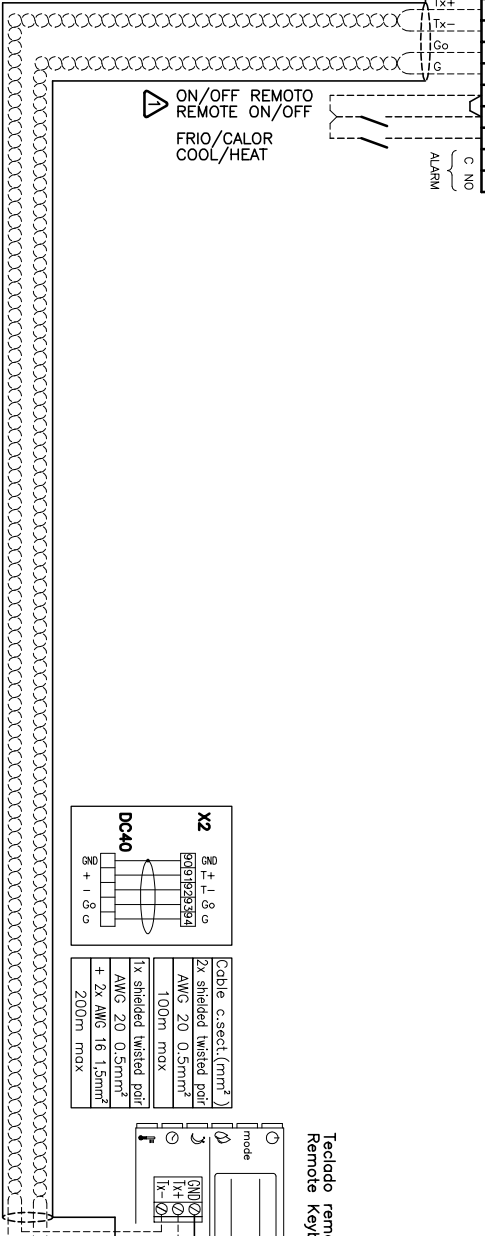

VER MANUAL INSTALACION
SEE INSTALLATION MANUAL (IOM)
VOIR LE MANUEL D'INSTALLATION
SIEHE INSTALLATIONSHANDBUCH (IOM)

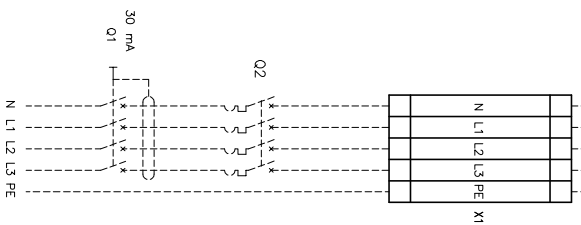
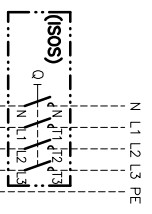

RETRIRAR PUENTE SI SE MONTA ON/OFF REMOTO
REMOVE LINK FOR REMOTE ON/OFF OPERATION
RETRIRER LE PONT EN CAS DE MARCHE/ARRÊT A DISTANCE
ENTFERNE DIE VERBINDUNG ZUM EIN/AUS FERNSCHALTER

ESTAS BORNAS SOLAMENTE SE INCLUYEN CON SU OPCIONAL
THESE TERMINALS ARE ONLY INCLUDED WITH ITS OPTIONAL
CES CONTACTS SONT INSTALES SEULEMENT SI ON DEMANDE CHOISI L'OPTION
DIESE ANSCHLUSSKLEMMEN SIND NUR MIT ZUBEHÖR VERFÜGBAR IHREM OPTIONAL

SCREEN WIRE

Elemento Opcional
Optional Element
Element optionnel
Optiondes bouiteil

A realizar por el instalador
To wire by the installer
A cobler par l'installateur
Verdrchtung durch den installateur

1/5
Lemnox Refoc S.A.

ESQUEMA ELECTRICO
ELECTRIC DIAGRAM

FMH 15-20-25-30
(FIH+FSH)

4Z-33-383-311 43N
3N~400V 50HZ + PE
ALIMENTACION
POWER SUPPLY
ALIMENTATION ELECTRIQUE
STROMZULEITUNG
3N~400V 50HZ+PE

5 10 15 20 25 30 35 40 45 50 55 60 65 70 75 80 85 90 95 100

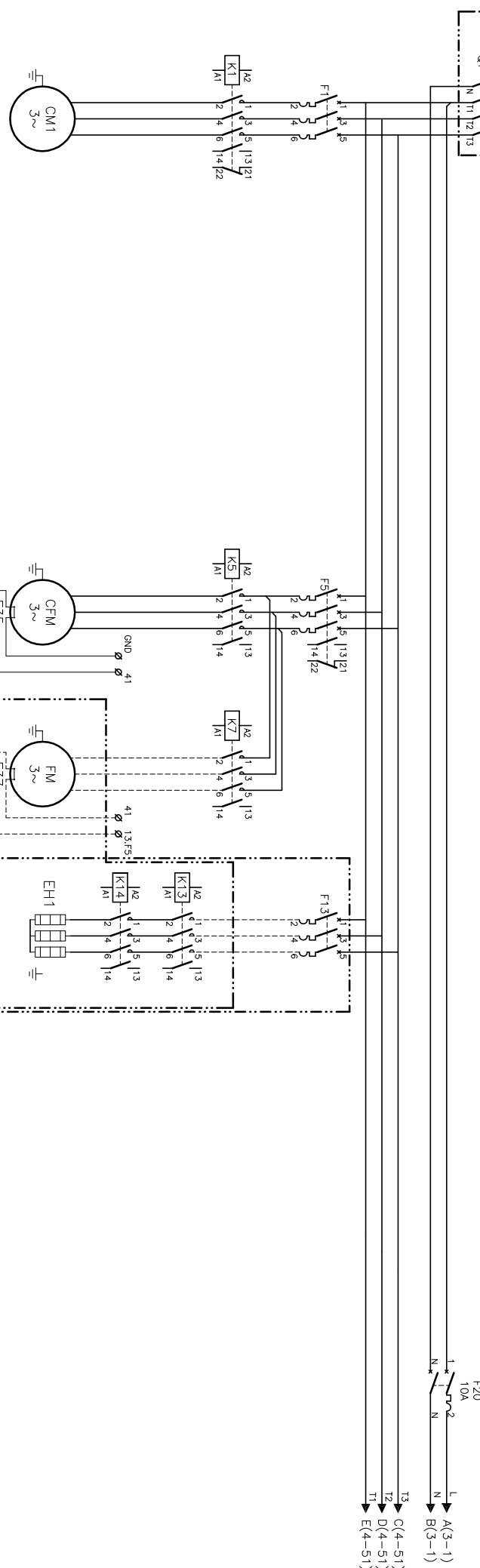
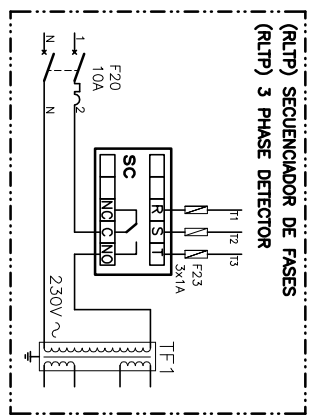
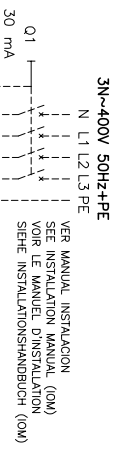

	ELHS	ELHM	ELHH		
FMH 15	4.5kW-1SI 6kW-1SI	6.5A 8.7A	9kW-1SI 13.0A		
FMH 20	6.10A 8.7A	9.14A 13.0A			
FMH 25	8.7A 13.0A				
FMH 30	13.0A 17.3A				
FMH 15	4.5kW-1SI 6kW-1SI	6.5A 8.7A	9kW-1SI 13.0A		
FMH 20	6.10A 8.7A	9.14A 13.0A			
FMH 25	8.7A 13.0A				
FMH 30	13.0A 17.3A				

Elemento Opcional
 Optional Element
 Element optionnel
 Optionales bouteille

A realizar por el instalador
 To wire by the installer
 A cobler par l'installateur
 Verdrahtung durch den Installateur

2/5 Lemnox Refco S.A.

ESQUEMA ELECTRICO
 ELECTRIC DIAGRAM

FMH 15-20-25-30
 (FIH+FSH)

4Z-33-383-311 43N
 3N ~400V 50Hz + PE

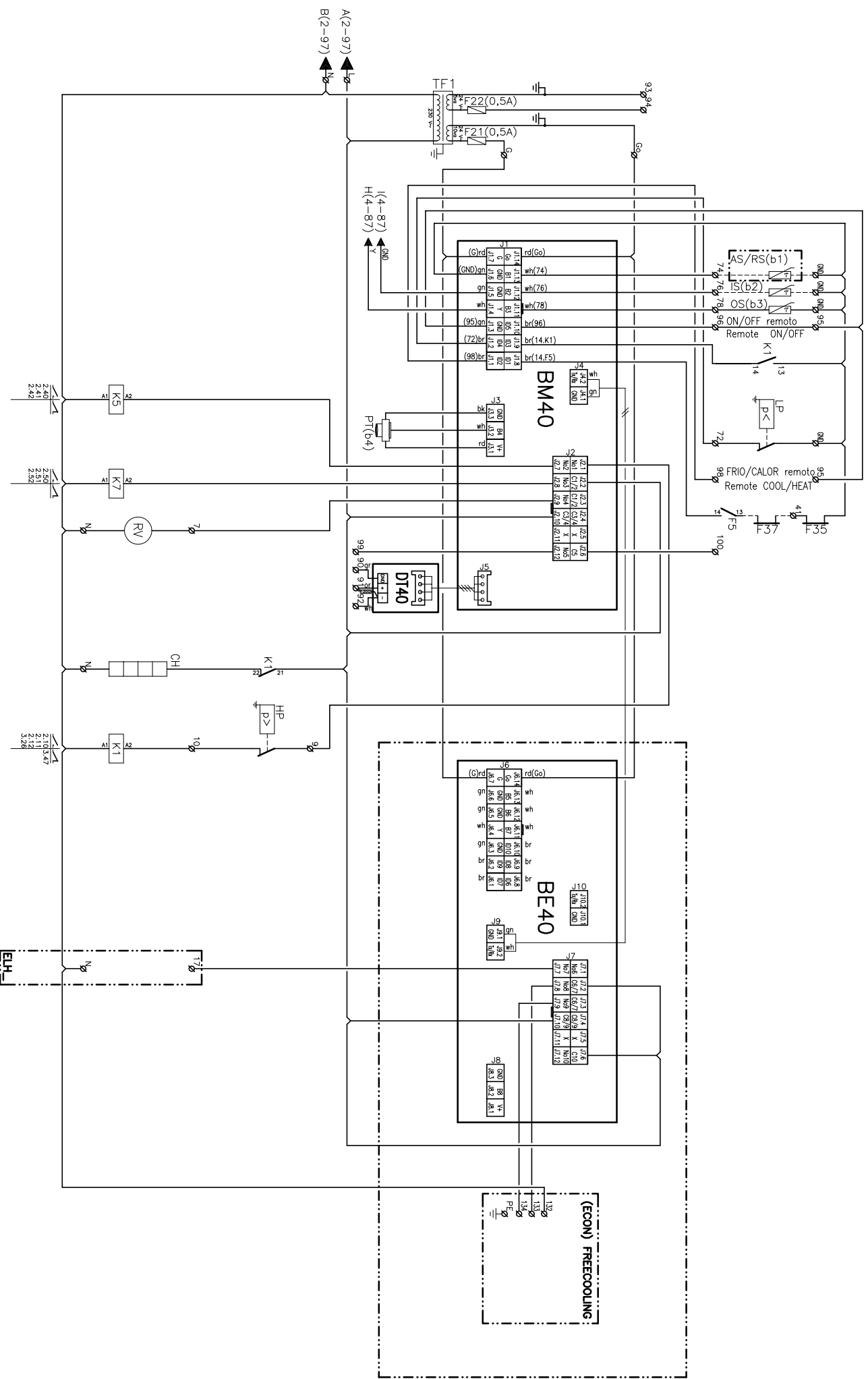

Elemento Opcional
Optional Element
Element optionnel
Optionelles boutail

A realizar por el instalador
To wire by the installer
A cobler par l'installateur
Verdrahtung durch den Installateur

3/5

Lennox Refoc S.A.
ESQUEMA ELECTRICO
ELECTRIC DIAGRAM

FMH 15-20-25-30
(FIH+FSH)

4Z-33-383-311 43N
3N ~400V 50HZ + PE

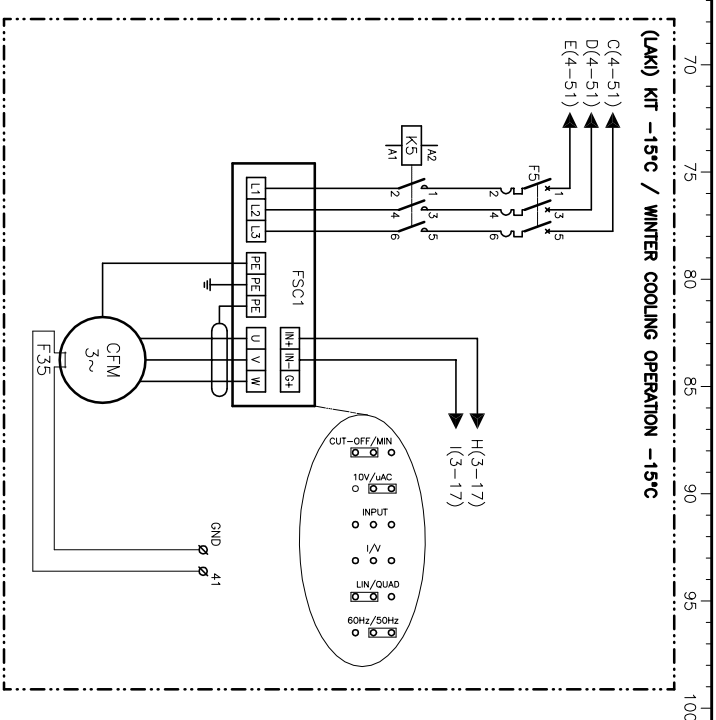
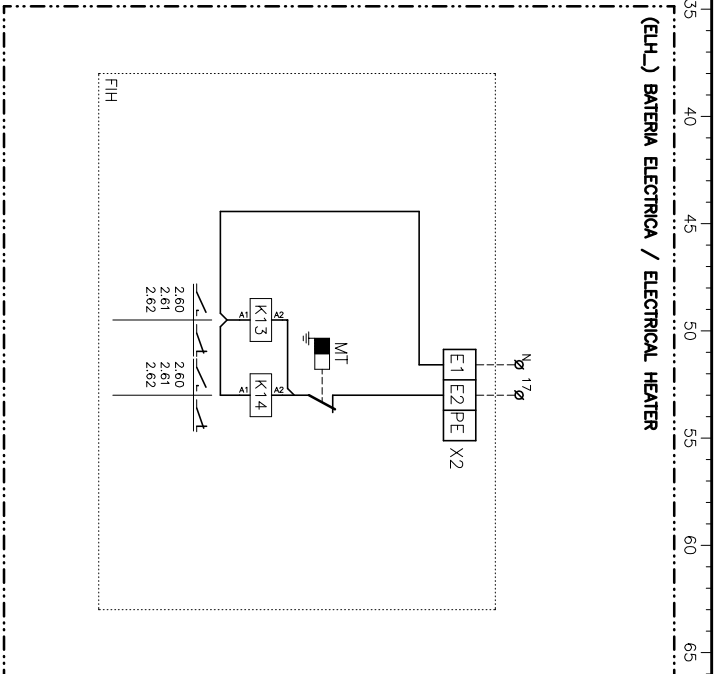
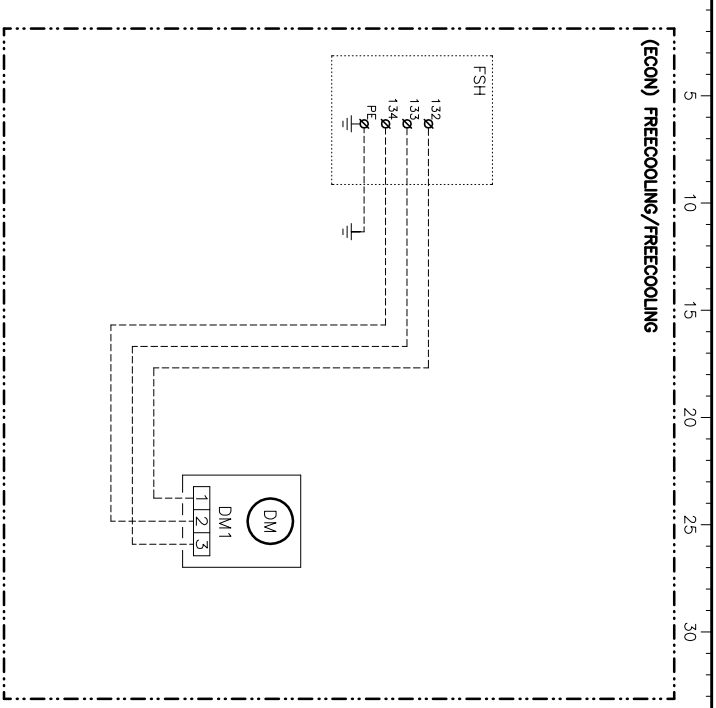

(ECON) FREECOOLING/FREECOOLING

(ELH) BATERIA ELECTRICA / ELECTRICAL HEATER

(LAK) KIT -15°C / WINTER COOLING OPERATION -15°C

Elemento Opcional
 Optional Element
 Element optionnel
 Optionelles bauteil

A realizar por el instalador
 To wire by the installer
 A cobler par l'installateur
 Verdrahtung durch den Installateur

4/5

Lemnox Refoc S.A.

ESQUEMA ELECTRICO
 ELECTRIC DIAGRAM

FMH 15-20-25-30
 (FIH+FSH)

4Z-33-383-311 43N
 3N ~400V 50HZ + PE

	5	10	15	20	25	30	35	40	45	50	55	60	65	70	75	80	85	90	95	100
AS/RS BE40 BM40 C CFM CM DC40 DM DT40 ECON EH F01 F05 F13 F20 F21-22-23 F31-37 FM HP Iq(LRA) Im(WCC) IS K LP MT OS PT Q Q1 Q2 RC RLTP RV TF1	LEYENDA	Sonda temperatura ambiente remota Modulo expansion CL40 Modulo logico Condensador Motor ventilador exterior Resistencia de carter Motor compresor Control Remoto Servomotor compuesta Modulo TTL-485 Freecooling Bateria electrica Magneto térmico Magneto térmico Magneto térmico Magneto térmico Fusible del TF1-SC Protección térmica Motor ventilador interior Presostato de alta Intensidad de arranque Intensidad máxima Sonda temperatura bateria interior Contacto Presostato baja Termostato seguridad (70°C automático) Sonda temperatura exterior Transductor alta presión Interruptor general Interruptor diferencial Interruptor magneto térmico Control Remoto Relé control de secuencia—fallo de fases Válvula inversora (frío ON) Transformador	LEGEND	Ambient remote sensor Expansion Module CL40 Logic Module Capacitor Compressor fan motor Crankcase heater Compressor motor Remote Control Damp actuator TTL-485 Module Freecooling Electrical heater Circuitbreaker Circuitbreaker Circuitbreaker Circuitbreaker Circuitbreaker TF1-SC fuse Thermal protection Indoor fan motor High pressure pressostat Starting current Maximum current Indoor coil temperature sensor Contacto Low pressure pressostat Safety thermostat (open 70° autom. reser) Outdoor temperature sensor High pressure transducer Main switch Ground safety switch Circuit breaker Remote Control Phase sequence and failure control relay Reversing valve (cooling ON) Transformer	REFERENCE	Sonde temp. à distance Carte Extension CL40 Module de Control Condensateur Moteur ventilateur extérieur Résistance de carter Compresseur Contrôleur à distance Servomoteur registre Module de TTL-485 Freecooling Résistance électrique Disjoncteur Disjoncteur Disjoncteur Disjoncteur Disjoncteur Disjoncteur Fusible TF1-SC Protection thermique Moteur ventilateur intérieur Pressostat HP Intensité de démarrage Intensité maximal Sonde temp. batterie intérieures Contacteur Pressostat BP T.securité (70°C automatique) Senseur extérieure du température Transducteur de haute pression interrupteur général interrupteur différentiel interrupteur magneto thermique Contrôleur à distance Décteur de phases Vanne 4 voits (activé en mode froid) Transformateur	LEGENDE	Umgebungstemperaturfühler Erweiterungsmodul CL40 Logik Modul Kondensator Kondensatorlüftermotor Kurbelgehäuseheizung Kompressor Fernbedienung Klappenantrieb TTL-485 Modul Freie-Kühlung Heizstufe Motorschutzschalter Motorschutzschalter Motorschutzschalter Motorschutzschalter Motorschutzschalter TF1-SC G-Sicherung Therm. Relais Innenventilatormotor Hochdruckpressostat Anlaufstrom Maximale Stromstärke Temperaturfühler Verdampfer 1 Schütz Niederdruckpressostat Sicherheitsther. (70° automatisch) Außertemperaturfühler High Druckkühnnehmer Hauptschalter Schalter MotorschutzSchalter Fernbedienung Prozentsiggenüberwachung+Strommeldes Ventil (kühlen ON) Transformator												
bk br rd or yl gn bl vi wh	CODIGO DE COLORES	negro marrón rojo naranja amarillo verde azul violeta gris blanco	COLOUR CODE	black brown red orange yellow green blue violet gray white	CODE COULEUR	noir brun rouge orange jaune vert bleu violet gris blanc	FARBKENNUNG	schwarz braun rot orange gelb grün blau violett grau weiss												

5/5

Lemnox Refoc S.A.

ESQUEMA ELECTRICO
ELECTRIC DIAGRAM

FMH 15-20-25-30
(FIH+FSH)

4Z-33-383-311

43N

3N ~400V 50HZ + PE