

5 10 15 20 25 30 35 40 45 50 55 60 65 70 75 80 85 90 95 100

INDICE	
REGLETERO CONEXIONES ELECTRICAS TERMINAL STRIP BORNIER DE CONNEXION ELECTRIQUE KLEMMLEISTE	HOJA 1/5
CIRCUITO POTENCIA POWER CIRCUIT CIRCUIT DE PUISSANCE STROMKREIS	HOJA 2/5
CIRCUITO MANIOBRA CONTROL CIRCUIT CIRCUIT DE CONTROL STUECKERKREIS	HOJA 3/5
CONEXION OPCIONALES OPTIONS CONNEXIONS OPTIONNELS OPTIONEN / ZUBEHÖR	HOJA 4/5
LEYENDA REFERENCIAS REFERENCES LEGEND REFERENCE DE LEGENDE LEGENDE	HOJA 5/5



ESQUEMA ELECTRICO
WIRING DIAGRAM
SCHEMA ELECTRIQUE
SCHALTPLAN

Elemento Opcional
Optional Element
Element optionnel
Optionelles bauteil

A realizar por el instalador
To wire by the installer
A câbler par l'installateur
Verdrahtung durch den Installateur

0/5

Lennox Refoc S.A.

ESQUEMA ELECTRICO
ELECTRIC DIAGRAM

FMC 10-12 (FIX+FSC)

4Z-33-379-212 03R
3N ~400V 50HZ + PE

5 10 15 20 25 30 35 40 45 50 55 60 65 70 75 80 85 90 95 100

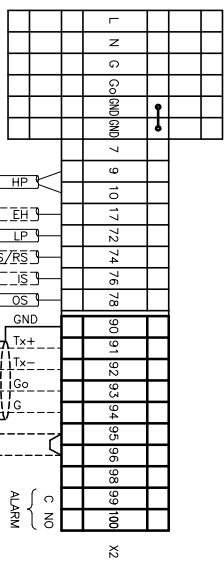
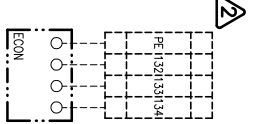

ON/OFF REMOTO
REMOTE ON/OFF

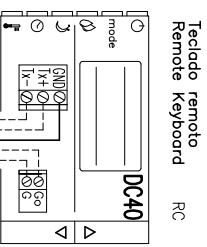
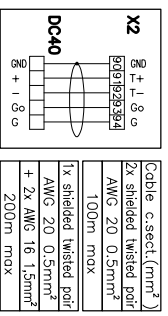
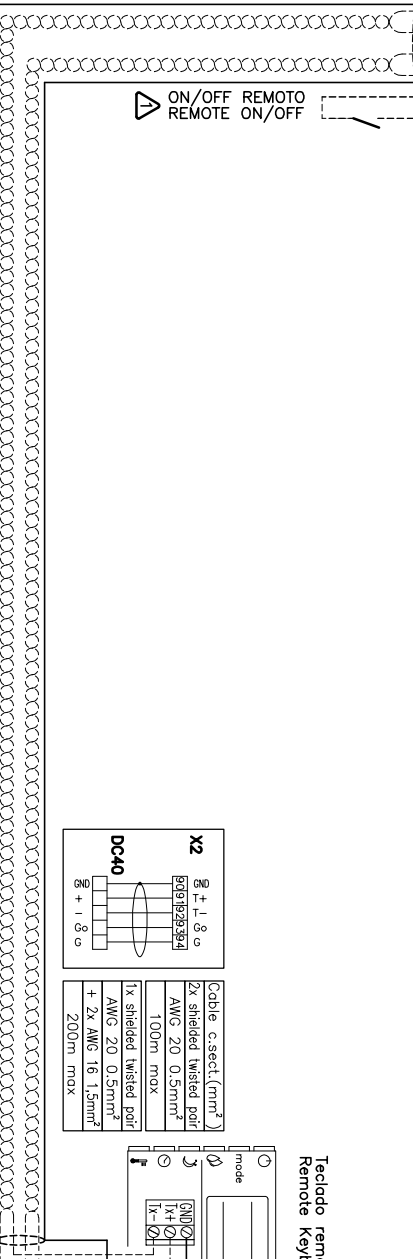

VER MANUAL INSTALACION
SEE INSTALLATION MANUAL (10M)
VOIR LE MANUEL D'INSTALLATION
SIEHE INSTALLATIONSHANDBUCH (10M)

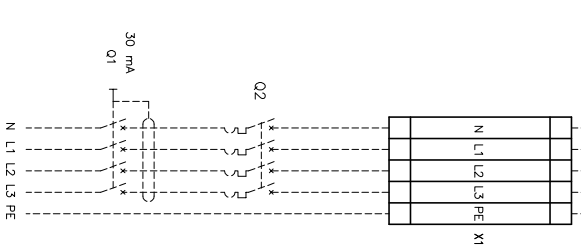
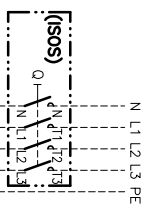

1 RETIRAR PUENTE SI SE MONTA ON/OFF REMOTO
REMOVE LINK FOR REMOTE ON/OFF OPERATION
RETRIERER LE POINT EN CAS DE MARCHE/ARRET A DISTANCE
ENTFERNE DIE VERBINDUNG ZUM EIN/AUS FERNSCHALTER

2 ESTAS BORNAS SOLAMENTE SE INCLUYEN CON SU OPCIONAL
THESE TERMINALS ARE ONLY INCLUDED WITH ITS OPTIONAL
CES CONTACTS SONT INSTALES SEULEMENT SI ON DEMANDE CHOISI L'OPTION
DIESE ANSCHLUSSKLEMMEN SIND NUR MIT ZUBEHÖR VERFÜGBAR IHREM OPTIONAL

A CABLE APANTALLADO
SCREEN WIRE

Elemento Opcional
Optional Element
Element optionnel
Optiondes bouiteil

A realizar por el instalador
To wire by the installer
A cobbler par l'installateur
Verdrahtung durch den installateur

1/5
Lemnox Refoc S.A.

ESQUEMA ELECTRICO
ELECTRIC DIAGRAM

FMC 10-12 (FIX+FSC)

ALIMENTACION
POWER SUPPLY
ALIMENTATION ELECTRIQUE
STROMZULEITUNG
4Z-33-379-212 03R
3N~400V 50HZ + PE

5 10 15 20 25 30 35 40 45 50 55 60 65 70 75 80 85 90 95 100

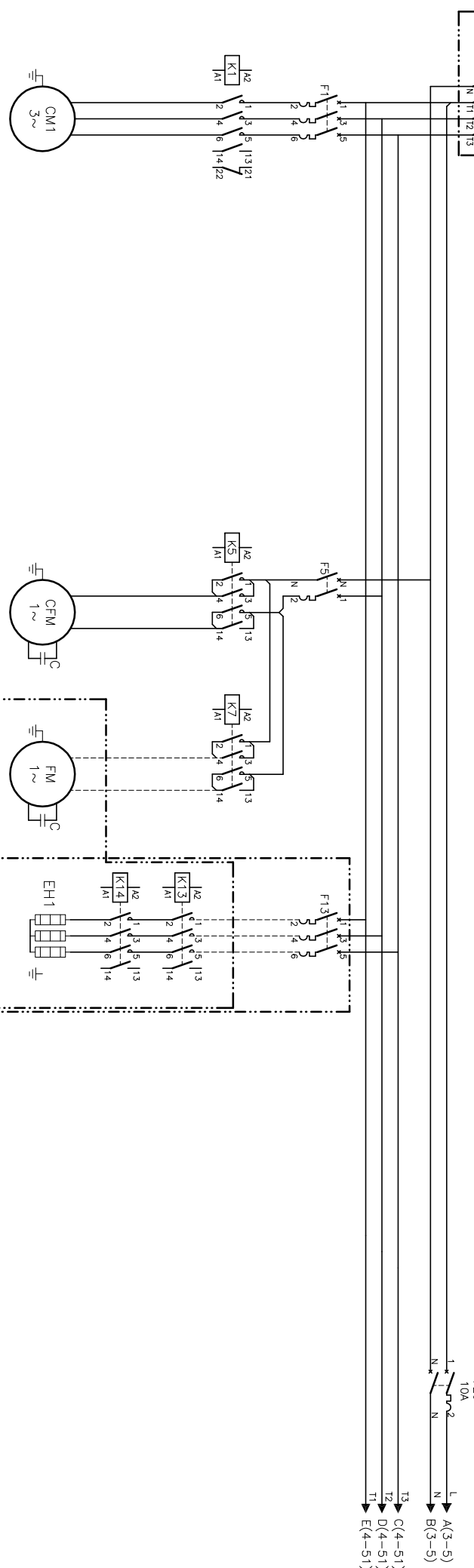
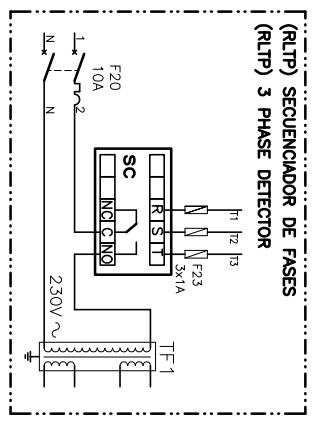
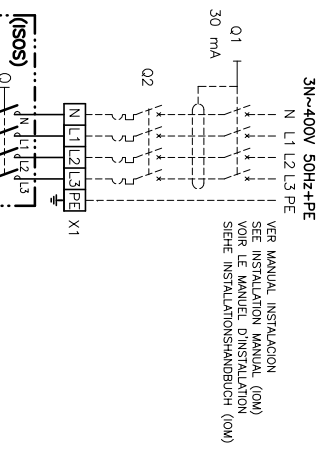

- CIRCUITO MANIOBRA
- CONTROL CIRCUIT
- CIRCUIT DE CONTROL
- STEUERKREIS

T3 C(4-51)
T2 D(4-51)
T1 E(4-51)

FMC	Im(CG) I _g (LRA)	Im(LRA)	Im(CG) I _g (LRA)	Im(LRA)	Im(CG) I _g (LRA)	Im(LRA)
10	8A 4.3A	3.1A 13.5A	2.6A 13.0A	3kW-15SI 4.3A	6kW-15SI 8.7A	9kW-15SI 13.0A
12	10.3A 5.15A	3.1A 15.5A	2.6A 13.0A	4.5kW-15SI 6.5A	6kW-15SI 8.7A	9kW-15SI 13.0A
F	9.14A	10A	6.10A	6.10A	6.10A	9.14A

Elemento Opcional
Optional Element
Element optionnel
Optionales bauteil

A realizar por el instalador
To wire by the installer
A cobler par l'installateur
Verdrahtung durch den installateur

2/5

Lemnox Refoc S.A.

ESQUEMA ELECTRICO
ELECTRIC DIAGRAM

FMC 10-12 (FIX+FSC)

4Z-33-379-212 03R
3N ~400V 50Hz + PE

5 10 15 20 25 30 35 40 45 50 55 60 65 70 75 80 85 90 95 100

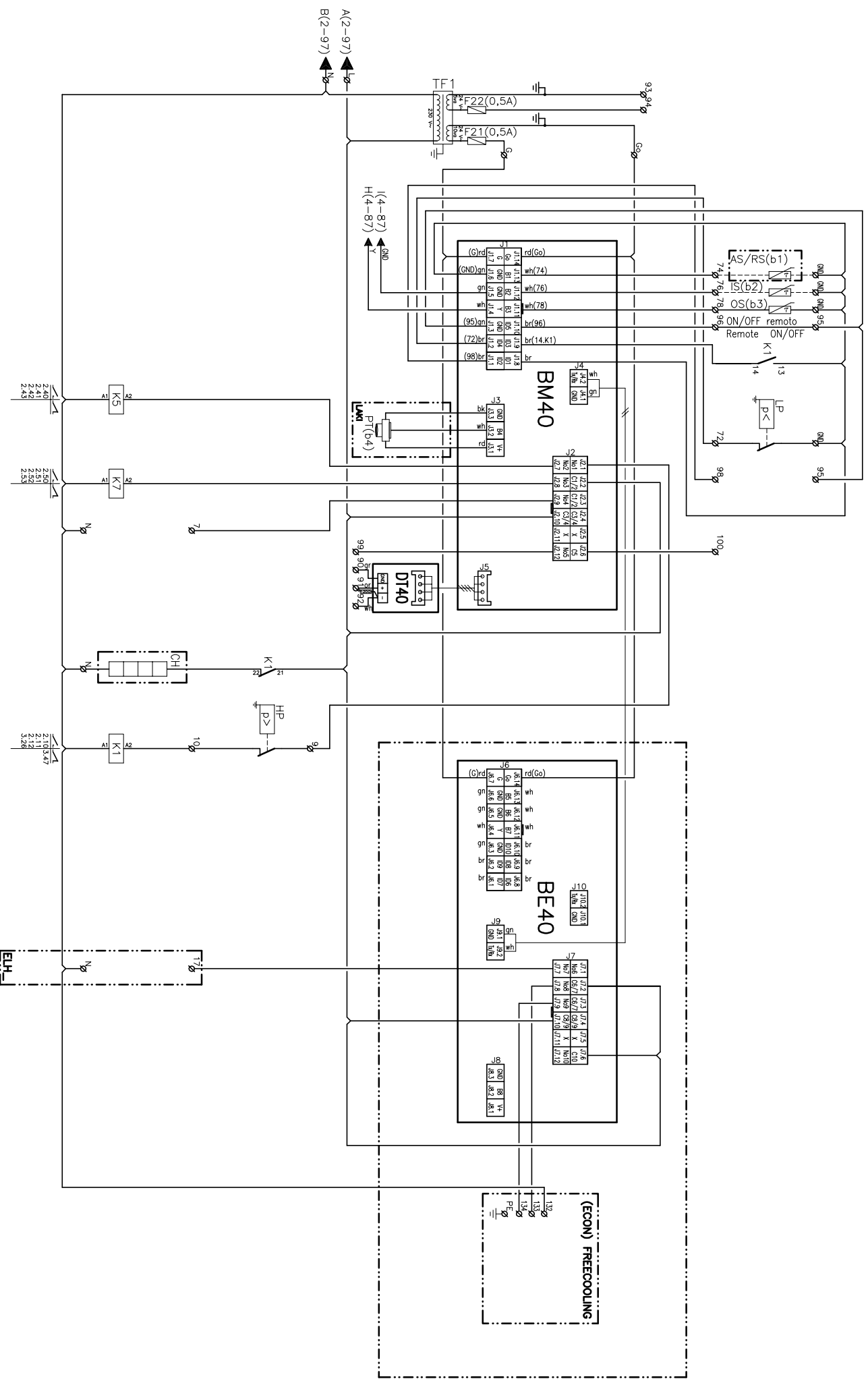

AK2-97) BK2-97)

Elemento Opcional
Optional Element
Element optionnel
Optionnelles bouteille

A realizar por el instalador
To wire by the installer
A cobler par l'installateur
Verdrahtung durch den Installateur

3/5

Lemnox Refoc S.A.

ESQUEMA ELECTRICO
ELECTRIC DIAGRAM

FMC 10-12 (FIX+FSC)

4Z-33-379-212 03R
3N ~400V 50HZ + PE

(ECON) FREECOOLING/FREECOOLING

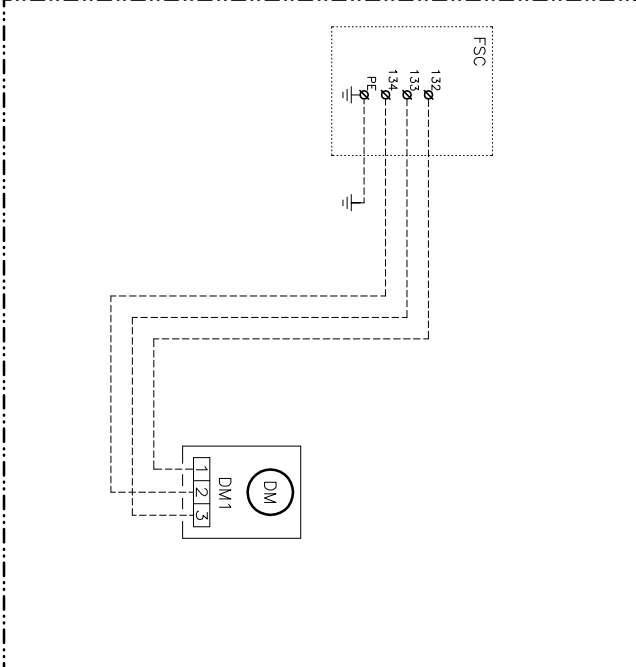

(ELH) BATERIA ELECTRICA / ELECTRICAL HEATER

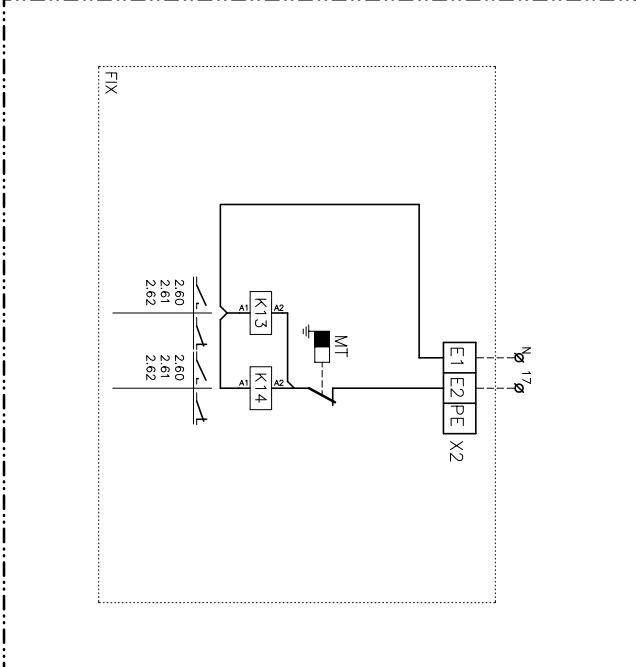

(LAK) KIT -15°C / WINTER COOLING OPERATION -15°C

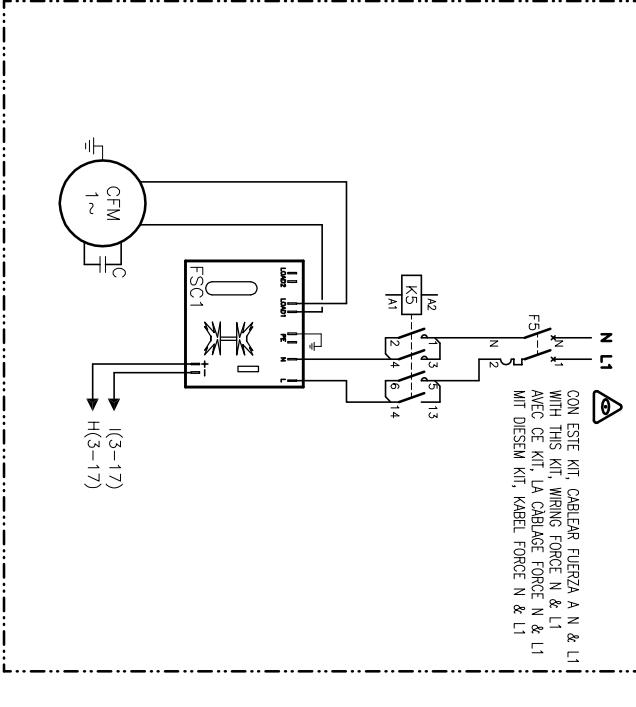

Elemento Opcional
 Optional Element
 Element optionnel
 Optiondes boueteil

A realizar por el instalador
 To wire by the installer
 A cobler par l'installateur
 Verdrahtung durch den installateur

4/5
 Lennox Refoc S.A.

ESQUEMA ELECTRICO
 ELECTRIC DIAGRAM

FMC 10-12 (FIX+FSC)

4Z-33-379-212 03R
 3N ~400V 50HZ + PE

	5	10	15	20	25	30	35	40	45	50	55	60	65	70	75	80	85	90	95	100		
AS/RS BE40 BM40 C CFM CH CM DC40 DM DT40 ECON EH F01 F05 F13 F20 F21-22-23 FM HP Ia(LRA) Ira(MCC) IS K LP MT OS PT Q Q1 Q2 RC RLTP TF1	LEGENDA	LEGEND	REFERENCE	LEGENDE																		
	Sonda temperatura ambiente remota Modulo expansion CL40 Modulo logico Condensador Motor ventilador exterior Resistencia de carter Motor compresor Control Remoto Servomotor compuesta Modulo TTL-485 Freecooling Bateria eléctrica Magneto térmico Magneto térmico Magneto térmico Magneto térmico Fusible del TF1-SC Motor ventilador interior Presostato de alta Intensidad de arranque Intensidad máxima Sonda temperatura bateria interior Contactador Presostato baja Termostato seguridad (70°C automático) Sonda temperatura exterior Transductor alta presión Interrupor general Interrupor diferencial Interrupor magneto térmico Control Remoto Relé control de secuencia-fallo de fases Transformador	Ambient remote sensor Expansion Module CL40 Logic Module Capacitor Compressor fan motor Crankcase heater Compressor motor Remote Control Dampner actuator TTL-485 Module Freecooling Electrical heater Circuitbreaker Circuitbreaker Circuitbreaker Circuitbreaker TF1-SC fuse Indoor fan motor High pressure pressostat Starting current Maximum current Indoor coil temperature sensor Contactador Low pressure pressostat Safety thermostat (open 70° autom. reser) Outdoor temperature sensor High pressure transducer Main switch Ground safety switch Circuit breaker Remote Control Phase sequence and failure control relay Transformer	Sonde temp. à distance Carte Extension CL40 Module de Control Condensateur Moteur ventilateur extérieur Résistance de carter Compresseur Contrôleur à distance Servomoteur registre Module de TTL-485 Freecooling Résistance électrique Disjoncteur Disjoncteur Disjoncteur Disjoncteur Disjoncteur Fusible TF1-SC Moteur ventilateur intérieur Pressostat HP Intensité de démarrage Intensité maximale Sonde temp. batterie interieures Contacteur Pressostat BP T.sécurité (70°C automatique) Sensueur extérieure du température Transducteur de haute pression Interrupteur général Interrupteur différentiel Interrupteur magneto thermique Contrôleur à distance Décteur de phases Transformateur	Umgebungstemperaturfühler Erweiterungsmodul CL40 Logik Modul Kondensator Kondensatorlüftermotor Kurbelgehäuseheizung Kompressor Fernbedienung Klappenantrieb TTL-485 Modul Freie-Kühlung Heizstufe Motor-Schutzschalter Motor-Schutzschalter Motor-Schutzschalter Motor-Schutzschalter Motor-Schutzschalter TF1-SC, G-Sicherung Innenventilatormotor Hochdruckpressostat Anlaufstrom Maximale Stromstärke Temperaturfühler Verdampfer 1 Schutz Niederdruckpressostat Sicherheitsther. (70° automatisch) Außertemperaturfühler Hight Druckkaufnehmer Hauptschalter Schalter MotorschutzSchalter Fernbedienung Phasenfolgenüberwachung+Strommeldes Transformator																		
	CODIGO DE COLORES	COLOUR CODE	CODE COULEUR	FARBKENNUNG																		
bk br rd or yl gn bl vi wh	negro marrón rojo naranja amarillo verde azul violeta gris blanco	black brown red orange yellow green blue violet gray white	noir brun rouge orange jaune vert bleu violet gris blanc	schwarz braun rot orange gelb grün blau violett grau weiss																		

5/5

Lemnox Refoc S.A.

ESQUEMA ELECTRICICO
ELECTRIC DIAGRAM

FMC 10-12 (FIX+FSC)

4Z-33-379-212 03R
3N ~400V 50HZ + PE