

# User manual

## CLIMATIC™ 50

### ROOFTOP & AIRCOOLAIR



- Providing indoor climate comfort





# Climatic 50

## Roof-Top & Aircoolair

# INSTALLATION OPERATING & MAINTENANCE MANUAL

Ref : CL50-RoofTop-IOM-1107-E

LENNOX have been providing environmental solutions since 1895, our range of Baltic™ rooftop continues to meet the standards that have made LENNOX a household name. Flexible design solutions to meet YOUR needs and uncompromising attention to detail. Engineered to last, simple to maintain and Quality that becomes a standard. Further Information on [www.lennox europe.com](http://www.lennox europe.com).

All the technical and technological information contained in this manual, including any drawing and technical descriptions provided by us, remain the property of Lennox and must not be used (except in operation of this product), reproduced, issued to or made available to third parts without the prior written agreement of Lennox.

The technical informations and specifications contained in this manual are for reference only. The manufacturer reserves the right to modify these without warning and without obligation to modify equipment already sold.

---

## TABLE OF CONTENTS

---

	Page
INTRODUCTION	3
CONNECTION	4
CONFIGURATION	8
SCHEDULING – CLOCK SETTING	10
VENTILATION	13
THERMOSTAT / HYGROSTAT – SET POINTS	15
THERMOSTAT / HYGROSTAT – CONTROL PRINCIPLE	17
FRESH AIR DAMPER - FREE-COOLING	18
COMPRESSORS	20
DEFROST – HEAT PUMP	22
SUPPLEMENT OF HEATING (OPTION)	23
CUSTOMIZED INPUT/OUTPUT	25
FAULT CODES	
Insufficient airflow	28
Filters Clogged or Missing	29
Ambient Temperature and Humidity, Outside Limits	30
Blowing temperature, outside limits	31
Overheating of Electrical Heating Elements	32
Gas Burner Faults	33
External Humidifier fault	34
Hot Water Circulator Fault	34
Fault in Real Time Clock	35
Extension card fault (BE50)	35
Faulty Probes and Sensors	36
Blowing fan	37
Condenser fans	38
Water Condenser Faults	39
Smoke Detector	40
Compressors shut down on LP cut off	41
Compressor shut down onHP cut off or electrical protection	42
COMMUNICATION	43
MASTER/SLAVE	43
BMS	45
CONFIGURING THE BM50 PLAN ADDRESS	46
ALLOCATION OF DISPLAYS TO THE BM50	47
DC50 COMFORT & DM50 MULTI CUSTOMER DISPLAY	48
DS50 SERVICE DISPLAY	53
DS50 MENU TREE	59
CLIMATIC™50 INPUT/OUTPUT MAPPING	67
MODBUS, LONTALK ADRESS TABLES	70

---

## INTRODUCTION

---

### CLIMATIC™50

The new generation of microprocessor based control, CLIMATIC™ 50 may be fitted to the Lennox Roof-Top or AirCooler range. It inherits 20 years of technology and field operating experience from its predecessors the CLIMATIC™1 and CLIMATIC™ 2.

LENNOX has found the latest hardware technology available on the market place and developed a software specifically designed for Roof-Top and AirCooler applications, maximising the LENNOX units efficiency and performance.

### Compatibility

This documentation is compatible with the programs Roof Top and AirCooler:

- **Ranges Baltic, Flexy I, Flexy II, FX and AC, starting from the version 20.0**

### Warning

**Any parameter modification should be carried out by trained and licensed competent technician.**

**Before start-up or restart of a unit controlled by Climatic 50, it is mandatory to check adequacy between Climatic 50 and the unit with its options.**

- **38xx menus for unit and options**
- **39xx menus for communication**

**In case of wrong parameters, I/O links could be incorrect and may create some operation problems for the units and ultimately breakdowns.**

**Lennox cannot be held responsible for any claims on the units due to a wrong parameters sequence or a parameters modification carried out by non competent technicians. In this case, the warranty will be legally null and void.**

## WIRING CONNECTIONS

### **IMPORTANT WARNING**

**Any wiring modification on the CLIMATIC 50 must be done by Lennox technician or employees having valid electrical qualification and authorisation.**

**For any modification of wiring on the 24V supply or on 4-20mA sensor, check the polarity prior to apply the power. Wrong polarity may cause serious damage and destroy the Plan network. Lennox will not accept liability for damage caused by wrong power connection or any wiring modification done by people without valid training and qualifications.**

**Any external connection with the unit, using 24Vac voltage should not exceed a length of more than 30m. It concerns external contacts connected to Climatic™50 logical inputs or humidifier control connection to the output 0-10v.**

**Over 30 m, the installer must interface this information with relays or converters.**

**In any case, the 24Vac control voltage must not be used to drive external function with Climatic™50 logical output**

**WARNING:** Separate as much as possible probes, displays, logical input cables from power cables with strong inductive load, in order to avoid possible electromagnetic perturbations

### **CONNECTION**

#### **SENSORS AND PROBES**

External sensors or probes connection must be carried out with the following cable:

- Cable length up to 20m: AWG22 (0.34 mm<sup>2</sup>), 1 pair crossed with screen (2 pairs for CO2 sensor).
- Cable length up to 50m: LiYCY-P (0.34 mm<sup>2</sup>), 1 pair with general shield. (2 pairs for CO2 sensor).

The cable length should not exceed 50m.

For a better electromagnetic protection, Lennox recommends the use of LiYCY-P cable

#### **ROOM TEMPERATURE PROBE (NTC)**

The room temperature probe (- BT10) is connected to the Climatic™ main board BM50 50 entry B7 connector J6 (refer to the unit electrical wiring diagram).

#### **ROOM HUMIDITY SENSOR (0-20mA/Option)**

The room humidity sensor (- BH10) is connected to the Climatic™ extension board BE50 entry B1 connector J9 (refer to the unit electrical wiring diagram).

#### **ROOM AIR QUALITY SENSOR CO<sup>2</sup> (4-20mA / Option)**

The room air quality sensor (-BG10) is connected to Climatic™ main board BM50 entry B2 connector (refer to the unit electrical wiring diagram).

#### **DISPLAY DS50**

The Display DS50 can be connected to the Climatic™ either on one of the RJ12 connectors located on the board DT50, or directly on the main board BM50 connector J10.

Connection is carried out by the flat 1.5m cable delivered with this DS50.

In any the case, Display DS50 cannot be remotely connected.

In case of Master/Slave installation, one, and only one, display DS50 must be connected on the pLan bus.

#### **DISPLAY DC50 or DM50 (Remote CONNECTION)**

##### **Warning:**

**A wrong wiring of the display immediately damage it and/or the main board BM50.**

The optional DC50/DM50 is designed to be mounted on the wall.

Fit the cable from the DT50 board through the back piece

Fasten the back piece to the wall using the rounded head screws supplied in the packaging

Connect the cable from the main board on the connector on the back of the DC50 display

Fasten the front panel on the back piece using the flush head screws supplied

Finally fit the click-on frame

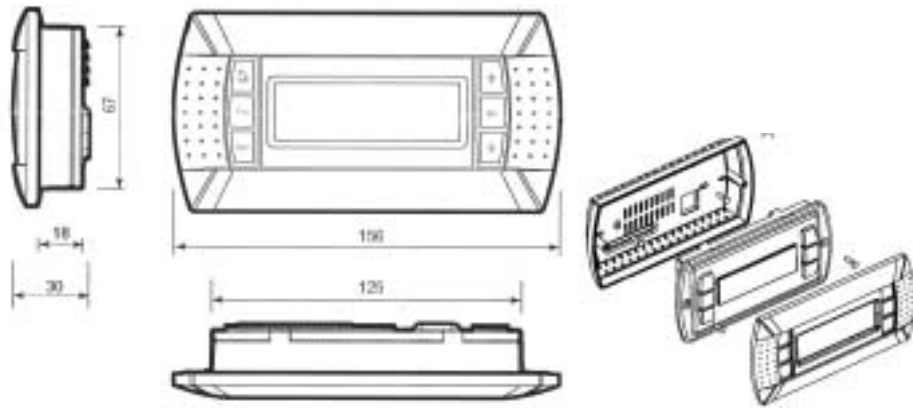

Display DC50 or DM50 is connected to the Climatic™ with the DT50 screw connector.

Connection must be carried out by the following cable:

- Cable length up to 300m: AWG22 (0.34 mm<sup>2</sup>), 2 pairs crossed with screen.
- Cable length up to 500m: LiYCY-P (0.34 mm<sup>2</sup>), 2 pairs with general shield.

The cable length should not exceed 500m.

For a better electromagnetic protection, Lennox recommends the use of LiYCY-P cable

**CONNECTION ON DT50 REPARTITOR**

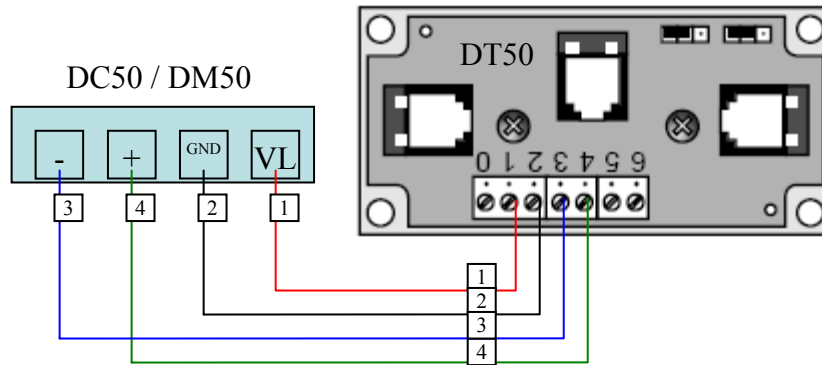

**Terminal connection board installation guide DT 50**

The board is fitted with three "telephone" RJ12 plugs. Ensure the board is correctly connected. Standard connection is:

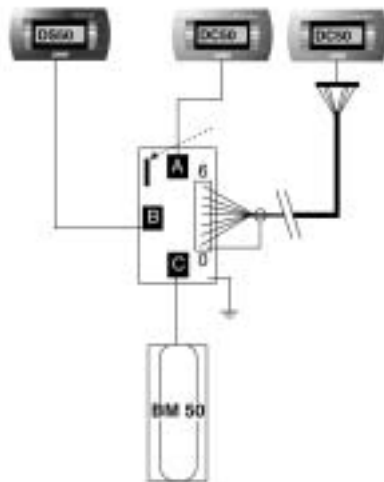

terminal	wire function	connections
0	earth	shield
1	+VRL (~30Vdc)	1st pair A
2	GND	2nd pair A
3	Rx/Tx-	3rd pair A
4	Rx/Tx+	3rd pair B
5	GND	2nd pair B
6	+VRL (~30Vdc)	1st pair B

BM50 on connector C  
 DC50/DM50 on connector A or SC  
 DS50 on connector B

Jumpers:

"Displays" are supplied directly by the Climatic board with 30Vdc. Take particular care at the path this 30V is taking when several boards are being used.

J14 and J15 can switch on or off the direct current from the power supply:

J14 and J15 set between 1-2 :

Connectors A, B, C and screw connector SC are in parallel. Power is supplied to all connectors.

J14 and J15 set between 2-3 :

Connectors B and C are powered in parallel but connector A and screw connector SC are not. Displays connected to these ports will not be powered.

**If J14 and J15 are set in different positions the "terminal connection board" DT50 DOES NOT WORK and so the connected displays do not operate.**

**DM50 and COMMUNICATION MASTER/SLAVE**

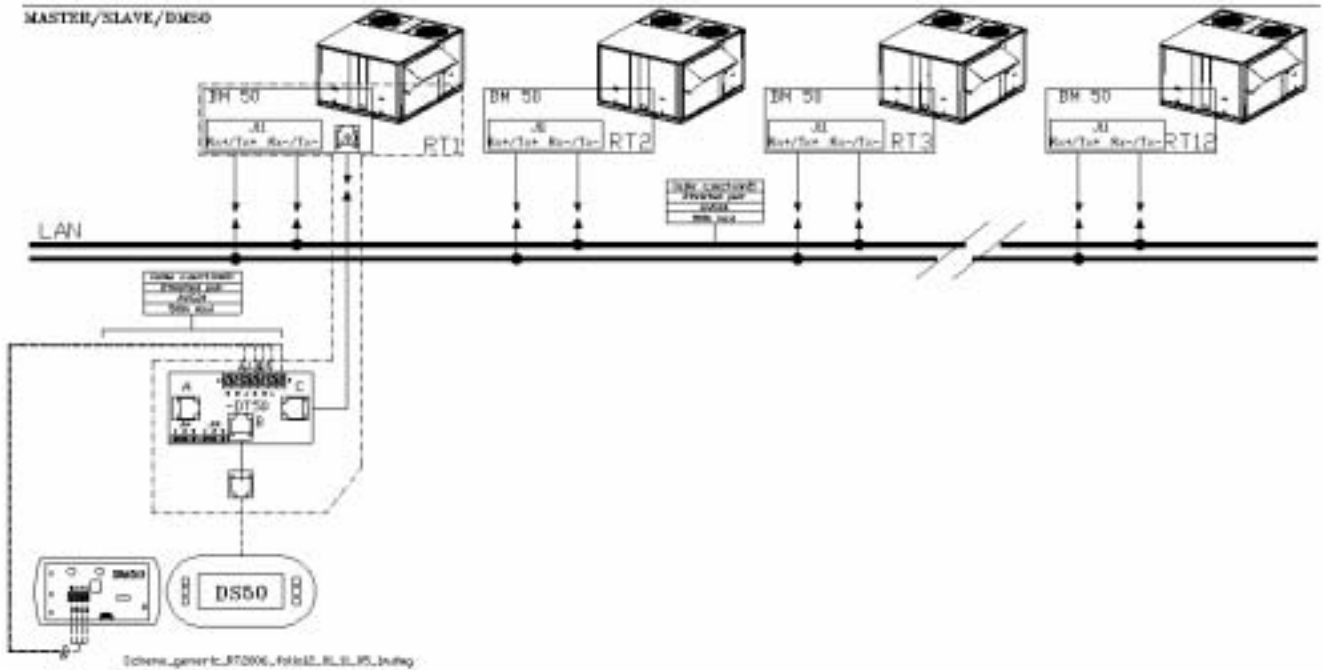

The intercard bus (pLan) is connected to Climatic™ on the J11 connector of board BM50.

A star connection is not recommended, for an optimum operation it is advised to connect a maximum of two cables per unit.

Connection must be carried out by the following cable:

- Cable length up to 300m: AWG22 (0.34 mm<sup>2</sup>), 2 pairs crossed with screen.
- Cable length up to 500m: LiYCY-P (0.34 mm<sup>2</sup>), 2 pairs with general shield.

The cable length should not exceed 500m.

For a better electromagnetic protection, Lennox recommends the use of LiYCY-P cable

**Warning:**

**The power 24Vac of boards BM50 should not be connected to the earth**

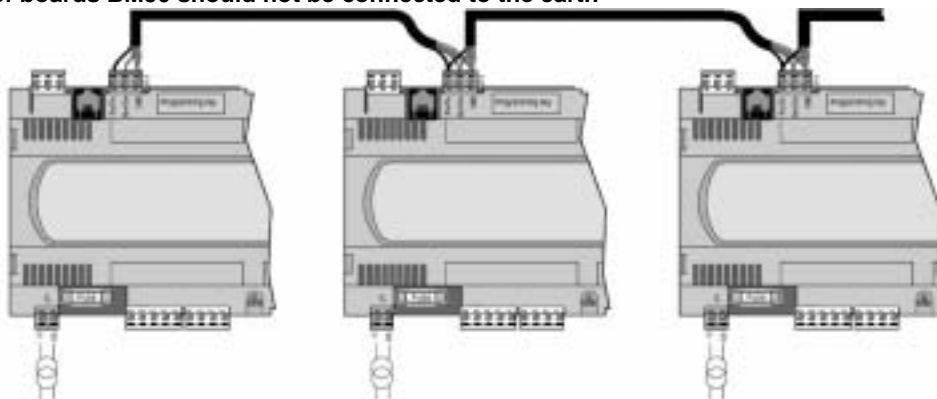



## BMS COMMUNICATION

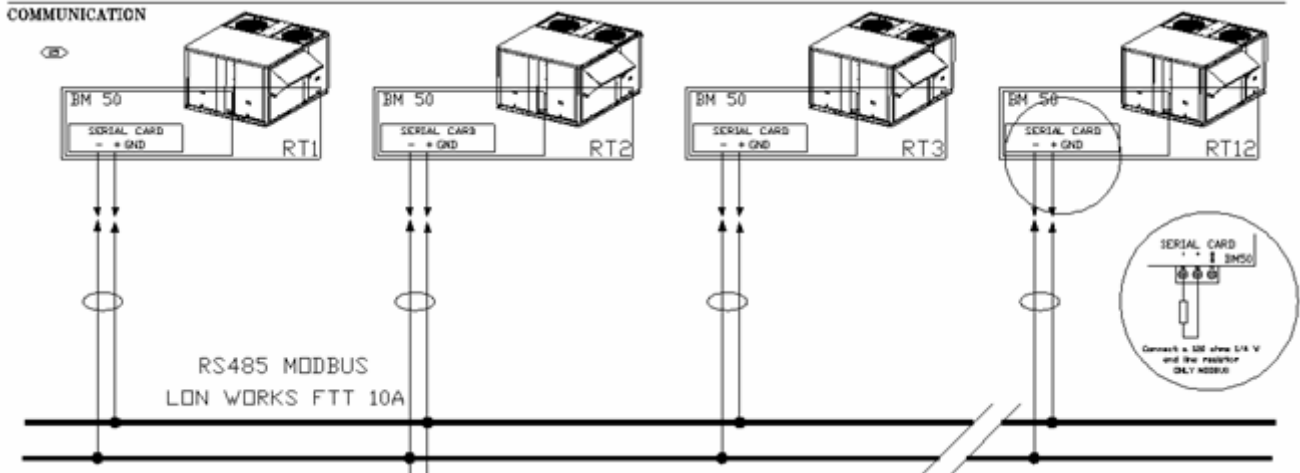

The communication bus is connected to Climatic™ Serial Card daughter board on the BM50.

A star connection is not recommended, for an optimum operation it is advised to connect a maximum of two cables per unit.

In case of RS485bus, a resistance of  $120\Omega$  1/4W can be connected on the last unit between the terminals + and -.

Connection must be carried out by the following cable:

- Cable length up to 300m: AWG22 ( $0.34 \text{ mm}^2$ ), 2 pairs crossed with screen.
- Cable length up to 1000m: LiYCY-P ( $0.34 \text{ mm}^2$ ), 2 pairs with general shield.

The cable length should not exceed 1000m.

For a better electromagnetic protection, Lennox recommends the use of LiYCY-P cable

# CONFIGURATION

## Function

LENNOX® proposes a single software for the whole ranges of Roof-Top and Aircooler.

For a first use, before any operation of the unit, Climatic™ must be set with parameters in accordance to the range, the size and the various options of the unit.

## Description

The unit configuration is done with following menus (refer also to Menu Tree chapter):

### 3811 → Unit range choice

[BC]	Baltic, cooling only
[BH]	Baltic, reversible (heat pump)
[BG]	Baltic, gas
[BD]	Baltic, gas and reversible (heat pump)
[BGM]	Baltic, gas, without compressor
[FC]	Flexy 1, cooling only
[FC²]	Flexy 2, cooling only
[FH]	Flexy 1, reversible (heat pump)
[FH²]	Flexy 2, reversible (heat pump)
[FG]	Flexy 1, gas
[FG²]	Flexy 2, gas
[FD]	Flexy 1, gas and reversible (heat pump)
[FD²]	Flexy 2, gas and reversible (heat pump)
[FGN]	Flexy, gas, without compressor
[FW]	Flexy, cool water coil, without compressor
[FX]	Roof-Top with module 4 dampers
[ANC]	Aircooler, cooling only
[ANH]	Aircooler, reversible (heat pump)
[NSR]	Unit of nonstandard request

### 3812 → Unit size choice

BC	BH	BG	BD	BGN	FC	FC²	FH	FH²	FG	FG²	FD	FD²	FGN	FWN	FX	ANC	ANH
BCK020NS	BHK020NS	BGK020SS	BDK020SS	BGN001S	FCK085N	FCM085N	FHK085N	FHM085N	FGK085S	FGM085S	FDK085S	FDM085S	FGN002S	FWN002S	FXX025N	ANCM022E	ANHM022E
BCK025NS	BHK025NS	BGK025SS	BDK025SS	BGN001H	FCK100N	FCM100N	FHK100N	FHM100N	FGK100S	FGM100S	FDK100S	FDM100S	FGN003S	FWN003S	FXX030N	ANCM026E	ANHM026E
BCK030NS	BHK030NS	BGK030SS	BDK030SS		FCK120N	FCM120N	FHK120N	FHM120N	FGK120S	FGM120S	FDK120S	FDM120S	FGN004S	FWN004S	FXX035N	ANCM032E	ANHM032E
BCK035NS	BHK035NS	BGK035SS	BDK035SS		FCK140N	FCM150N	FHK140N	FHM150N	FGK140S	FGM150S	FDK140S	FDM150S	FGN005S	FWN005S	FXX040N	ANCM038E	ANHM038E
BCK040NS	BHK040NS	BGK040SS	BDK040SS		FCK160N	FCM170N	FHK160N	FHM170N	FGK160S	FGM170S	FDK160S	FDM170S	FGN002H	FWN002H	FXX055N	ANCM043E	ANHM043E
BCK045NS	BHK045NS	BGK045SS	BDK045SS		FCK190N	FCM200N	FHK190N	FHM200N	FGK190S	FGM200S	FDK190S	FDM200S	FGN003H	FWN003H	FXX070N	ANCM052D	ANHM052D
BCK030ND	BHK030ND	BGK030SD	BDK030SD			FCM230N		FHM230N	FGK085H	FGM230S	FDK085H	FDM230S	FGN004H	FWN004H	FXX085N	ANCM064D	ANHM064D
BCK035ND	BHK035ND	BGK035SD	BDK035SD						FGK100H	FGM085H	FDK100H	FDM085H	FGN005H	FWN005H	FXX100N	ANCM076D	ANHM076D
BCK040ND	BHK040ND	BGK040SD	BDK040SD						FGK120H	FGM100H	FDK120H	FDM100H			FXX110N	ANCM086D	ANHM086D
BCK045ND	BHK045ND	BGK045SD	BDK045SD						FGK140H	FGM120H	FDK140H	FDM120H			FXX140N	ANCM112D	ANHM112D
BCK050ND	BHK050ND	BGK050SD	BDK050SD						FGK160H	FGM150H	FDK160H	FDM150H			FXX170N	ANCM128D	ANHM128D
BCK060ND	BHK060ND	BGK060SD	BDK060SD						FGK190H	FGM170H	FDK190H	FDM170H				ANCM152D	ANHM152D
BCK070ND	BHK070ND	BGK070SD	BDK070SD							FGM200H		FDM200H					
	BHK020HS	BGK020HS	BDK020HS							FGM230H		FDM230H					
	BHK025HS	BGK025HS	BDK025HS														
	BHK030HS	BGK030HS	BDK030HS														
	BHK035HS	BGK035HS	BDK035HS														
	BHK040HS	BGK040HS	BDK040HS														
	BHK045HS	BGK045HS	BDK045HS														
	BHK030HD	BGK035HD	BDK030HD														
	BHK035HD	BGK040HD	BDK035HD														
	BHK040HD	BGK045HD	BDK040HD														
	BHK045HD	BGK050HD	BDK045HD														
	BHK050HD	BGK060HD	BDK050HD														
	BHK060HD	BGK030HD	BDK060HD														
	BHK070HD	BGK070HD	BDK070HD														

### 3813 → Activation of the Controls humidity option

### 3814 → Activation of the High Efficiency Main fan and/or Variable speed transmission option,

### 3815 → Activation of the External Thermostat Temperature Control option,

### 3821 → Choice of the type of sensor or probe on the refrigeration circuit

[No]	No probe or sensor of installed on the circuits
------	---

- [NTC] Temperature probe 'NTC' on the sticks of the coils
- [0-5V] Transmitter of pressure 'Ratiométrique' on the circuits
- [4-20mA] Transmitter of pressure '4-20mA' on the circuits
- 3822** → Activation of the Low Ambient Kit option,
- 3823** → Unit with water condensation
- 3824** → Activation of the Alternate Defrost option for the Flexy1 range sizes 85 and 100
- 3831** → Choice of the auxiliary heating type.
  - [No] No auxiliary heating
  - [Hot W/Coil] Hot water coil
  - [Gas 2] Gas, 1 slope with 2 steps
  - [Gas 4] Gas, 2 slopes with 2 steps
  - [Gas 2 Pro.] Gas, 1 modulating slope
  - [Gas 4 Pro.] Gas, 2 modulating slope
  - [ElecH. Ste] Electric heaters, without Triac modulation.
  - [ElecH. Pro] Electric heaters, with Triac, Positioned after the refrigerant coil
  - [ElecH. Mix] Electric heaters, with Triac, Positioned before the refrigerant coil
- 3711** → Choice of the type of gas valves control board.
  - [BG50] Board BG50
  - [EF49] Board EF49
  - [EF48] Board EF48
  - [EF45] Board EF45
  - [MMI No] Block gas with output fault in normally open
  - [MMI Nc] Block gas with output fault in normally closed
- 3832** → Choice of the type air mixing box
  - [No] No fresh air
  - [100%] All fresh air
  - [0%-100%] Economiser proportional
  - [0%-50%] Economiser proportional, limitation to 50% of opening
- 3517** → Activation of the air heat recovery option,
- 3833** → Choice of the type of air flow sensor
  - [No] No option
  - [500pa] Sensor, 0 to 500 pa
  - [1000pa] Sensor, 0 to 1000 pa
- 3834** → Choice of the air quality sensor
  - [No] No option
  - [0-2000] Sensor, 0 to 2000 ppm
  - [350-2000] Sensor, 350 to 2000 ppm (Carel© brand sensor)

# SCHEDULING – CLOCK SETTING

## CLOCK SETTING

### Function

Climatic™ has a real time clock board, allowing dates and hours functionalities (weekly Program, event recording,...).

### Description

Menus 3121 to 3125 give the possibility of setting the internal clock.

The day of the week is calculated by Climatic™.

For the countries of the Euro a device allows the automatic swing of the hour summer in hour winter and vice versa. This functionality can be cancelled by menu 3126.

3121 → Hour.

3122 → Minute.

3123 → Day of the month.

3124 → Month.

3125 → Year.

3126 → Enable automatic switch summer time / winter time.

## SCHEDULING

### Function

Controlling operation of the unit according to the time and day

### Description

CLIMATIC™ 50 can handle 4 time zones over the 7 days of the week:

- Zone unoccupied « Night »
- Zone A « Day A »
- Zone B « Day B »
- Zone C « Day C »
- 

Starting time (hours and minutes) of each of these zones for each days of the week, can be set using menus 3211 to 3214, (press 'Prg' key to change day).

Each set point integrates the hour and minute's adjustment, thus a value of 8.3 equal 8.30 a.m.

3211 → Hour, minute of the night starting time (unoccupied)

3212 → Hour, minute of the "day A" starting time

3213 → Hour, minute of the "day B" starting time

3214 → Hour, minute of "day C" starting time

	8h00	12h00	13h50	20h30	22h00
Monday	Unoccupied	Z :A	Z :B	Z :C	Unoccupied
Tuesday					
Wednesday					
Thursday					
Friday					
Saturday					
Sunday					

For each time zone, the set following set points following can be modified:

LIST SET POINT BY ZONE	Code	DISPLAY CONFORT	DISPLAY MAINTENANCE
<b>Ambient temperature</b>			
Set point average	3311	Yes	Yes
Set point dynamic	3321	Yes	Yes
Cooling Set point	3322		Yes
Heating Set point	3323		Yes
Priority of heating	3324		Yes
<b>Reheating of Fresh Air</b>			
Enable	3331		Yes
Priority of heating	3332		Yes
<b>Fresh Air</b>			
Set point	3312		Yes
<b>Humidity</b>			
Dehumidification	3341		Yes
Humidification	3342		Yes
<b>Authorisation</b>			
Free Cooling	3353		Yes
Fresh Air by CO <sup>2</sup>	3354		Yes
Refrigeration by compressor	3355		Yes
Heating by compressor	3356		Yes
Auxiliary heating	3357		Yes
Humidity Control	3358		Yes
Low noise level	3359		Yes
<b>Other</b>			
Fan, Activate	3351		Yes
Fan, Activate, in dead zone	3352		Yes
Minimum fresh air (%)	3353	Yes	Yes
<b>Programming</b>			
Beginning of zone; each day		Yes	Yes
Start Uno	3211	Yes	Yes
Start z.A	3212	Yes	Yes
Start z.B	3213	Yes	Yes
Start z.C	3214	Yes	Yes

With the DS50, for each set point, to press on the key 'Prg' to change the periods and to validate the good set point for the good zone.

**Note:** "Monday" is considered as the first day of the week for programming the CLIMATIC™50.

**Factory settings:**

"Day A" activated from Monday to Saturday 6h→22h  
Night mode (unoccupied) for the remaining of time, Sunday included

## ANTICIPATION

### Function

This allows an anticipated start-up in the morning depending on the outdoor temperature.

### Description

This function only works for zone A, and allow the machine to move from unoccupied zone to zone A earlier if the outdoor temperature is under a certain value. Use this function to anticipate the heating start-up during cool days.

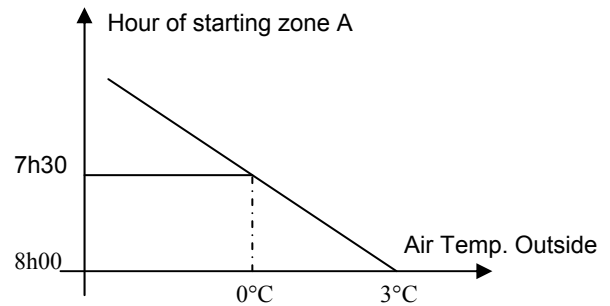

This can be adjusted with set point 3221 and 3222.

**3221** → bottom of the slope (°C), Anticipation starting point

**3222** → Slope in Minutes of anticipation per degrees

#### **Example:**

Unit with Day A starting at 8.00 am; 3221 set to 3°C and 3222 set to 10 mn/°C;

If the outside temperature is 0°C, then Day A will start at 7.30 a.m.

## VENTILATION

### ON / OFF (Start & Stop)

#### Function

In general, the unit is considered in operation if its supply fan is in operation.  
But, according to the set points, the fan may stop in the temperature control dead zone.

#### Description

To allow the operation of the unit it is necessary that set point 3111 is set to 'On' and that the BM50 logical input ID7 on the J5 connector is closed.

The 3111 set point adjustment is available on the DC/DM50 with the ON/OFF functionality.

For each scheduled zone defined in Climatic™50, it is possible to set the start/stop state. This functionality allows the unit to stop during a period of time in the day.

When the Room temperature is within the regulation dead zone, for each scheduled zone defined in the Climatic™50 it is possible run or stop the fan

**3111** → Main On/Off.

**3351** → On/Off, adjustment by zone.

**3352** → On/Off in the temperature control dead zones, adjustment by zone.

### STAGGING START

#### Function

After a power shut-down, you may get the units to restart gradually in order to avoid overloading issues.

#### Description

The units do not need to be connected; they must simply have different pLan addresses, (see BM50 pLan address configuration).

This will enable them to restart (10 x their address number) seconds after the resumption of the power.

#### **Example:**

If a unit carries the address n°3, it will start again 30s (3 X 10 seconds) after the resumption of the power.

### HIGH EFFICIENCY FANS or/and WITH VARIABLE SPEED TRANSMISSION

#### Function

The supply fan variable speed option allows two functionalities;

Progressive start or stop (used for the textile duct inflation)

The speed reduction, in temperature control dead zone, in order to bring only the necessary fresh air quantity.

#### Description

The supply fan speed is originally fixed by the set point 3422.

The speed entered in this set point corresponds to nominal air flow of the installation. This set point can only be adjusted on site.

#### ***Progressive Start / Stop***

If set point 3423 is activated;

During fan start up, for 30s, the speed is fixed by the threshold set point 3421. Then during the next 30s the fan accelerates gradually to reach the speed fixed in the set point 3422.

During the fan stop, the speed gradually reduces to stop completely in 1 minute.

### ***Dead zone reduction speed in***

If set point 3424 is activated;

When the room temperature is in the regulation dead zone of regulation (no heating, nor cooling), the speed of the fan is fixed by the set point 3421 and the fresh air damper is opened at 100%.

If the minimum speed brings a fresh air quantity higher than the defined threshold, the fresh air damper will close proportionally to reach the desired value.

**3421** → Minimum fan speed threshold (%).

**3422** → Maximum fan speed threshold (%).

**3423** → Activation of progressive Start functionality.

**3424** → Activation of dead zone speed reduction functionality.

## **EXHAUST FANS**

### **Function**

From one to three exhaust fans can be controlled. The start and the stop of these fans depend on the opening of the fresh air damper.

### **Description**

The fans are activated if the fresh air damper opening percentage is higher than the thresholds fixed by the set points.

**3431** → Fresh air damper threshold, activation of the 1<sup>st</sup> fan (%).

**3432** → Fresh air damper threshold, activation of the 2<sup>nd</sup> fan (%).

**3433** → Fresh air damper threshold, activation of the 3<sup>rd</sup> fan (%).



# THERMOSTAT / HYGROSTAT – Set points

## SET POINTS, TEMPERATURE

### Function

Climatic™ is programmed in order to maintain a temperature as comfortable as possible with the most economic usage of the unit.

### Description

The room temperature is maintained between a minimum threshold - corresponding to the heating point - and a maximum threshold - corresponding to the cooling point. The regulation “dead zone” is defined between these two thresholds. In order to be user friendly, one temperature set point is used. This set point is in the middle of the dead zone.

If this set point is modified, it has priority on the 2 thresholds, but the dead zone range remains defined by the difference between the 2 thresholds.

If the Thresholds 3322 and 3323 are modified, set point 3311 is automatically calculated to their average value.

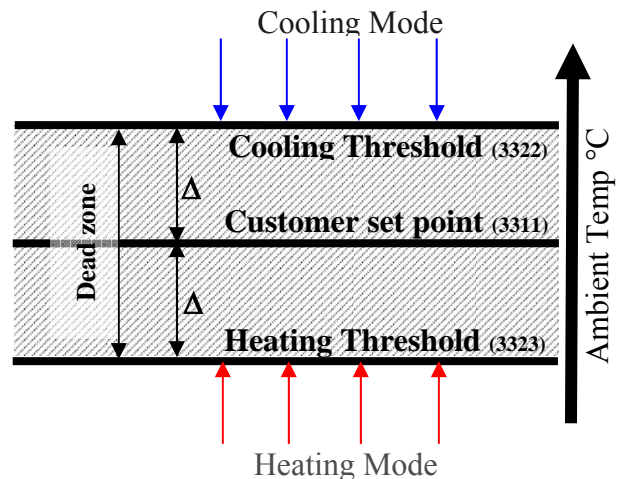

**3311** → Customer temperature set point (°C), adjustment by zone.

**3322** → Cooling temperature threshold (°C), adjustment by zone.

**3323** → Heating temperature threshold (°C), adjustment by zone.

### Set point modification by an external signal

The set point can be remotely modified with a signal 4-20mA (see CUSTOMIZED INPUT / OUTPUT)

For a 4 mA signal the temperature set point is decreased by 5°k

For a 20 mA signal the temperature set point is increased by 5°k

A linear rule is applied between the two signals.

## DYNAMIC SET POINT

### Function

This function allows to obtain a proportional shift of the cooling threshold according to the outside temperature.

### Description

The cooling threshold starts to increase once the outside air temperature is over the cooling threshold plus the value of the dynamic set point.

If you don't wish to use this function, allot to the option dynamic set point the value 99.9°c

#### Example:

If the cooling threshold is equal to 25°C and that the dynamic set point is equal to 6K

The cooling threshold drift will start for an outside temperature of 31°C (25°C + 6K) and then the threshold will follow the outside temperature evolution keeping a 6K difference.

**3321** → Dynamic set point (K), adjustment by zone.

## **FRESH AIR REHEATING SET POINT**

### **Function**

Climatic™ may be set to maintain a comfortable blowing temperature, by compensating the cold contribution of fresh air in winter.

### **Description**

If this function is activated:

- If the room temperature is in regulation dead zone, or heating mode, the blowing air regulation rule will maintain a blowing temperature at least equivalent to the heating threshold.
- If the room temperature is in cooling mode, the minimum blowing temperature will be equal to the safety low limit threshold plus 2K.

3331 → Activation of the control of reheating of the fresh air, adjustment per zone.

## **HUMIDITY SET POINT (option)**

### **Function**

The relative humidity of room is maintained between two thresholds, a minimum threshold corresponding to the point of humidification and a maximum threshold corresponding to the point of dehumidification.

### **Description**

#### ***Dehumidification***

It is ensured by the compressors in cooling mode.

It is active in the dead zone and cold mode of room temperature control.

Climatic™ gives priority to the temperature.

To ensure a complement of heating, the fresh air reheating set point must be activated.

#### ***Humidification***

A signal 0-10v is generated proportionally to the regulation request.

3341 → Dehumidification threshold - Relative humidity (%hr), adjustment by zone.

3342 → Humidification threshold - Relative humidity (%Hr), adjustment by zone.

3358 → Activation or inhibition, humidity control.

# THERMOSTAT / HYGROSTAT – Control principle

## Function

Adjust and hold the room air temperature or humidity as close as possible to the set point, by controlling the number of compressor stages depending on the thermal load of the system.

## Description

CLIMATIC™50 control constantly calculates the required capacity to reach the temperature set point. This variable is called “CAPACITY FACTOR” (CF) and its value can vary from 0 to 100%. It is directly linked to the number of control stages of the unit. Thus for a unit with 4 stages of regulation, the CF will start and stop a stage with the following values: 0-25-50-75-100.

It then evolves following the principles detailed in the diagram below (case of a cooler):

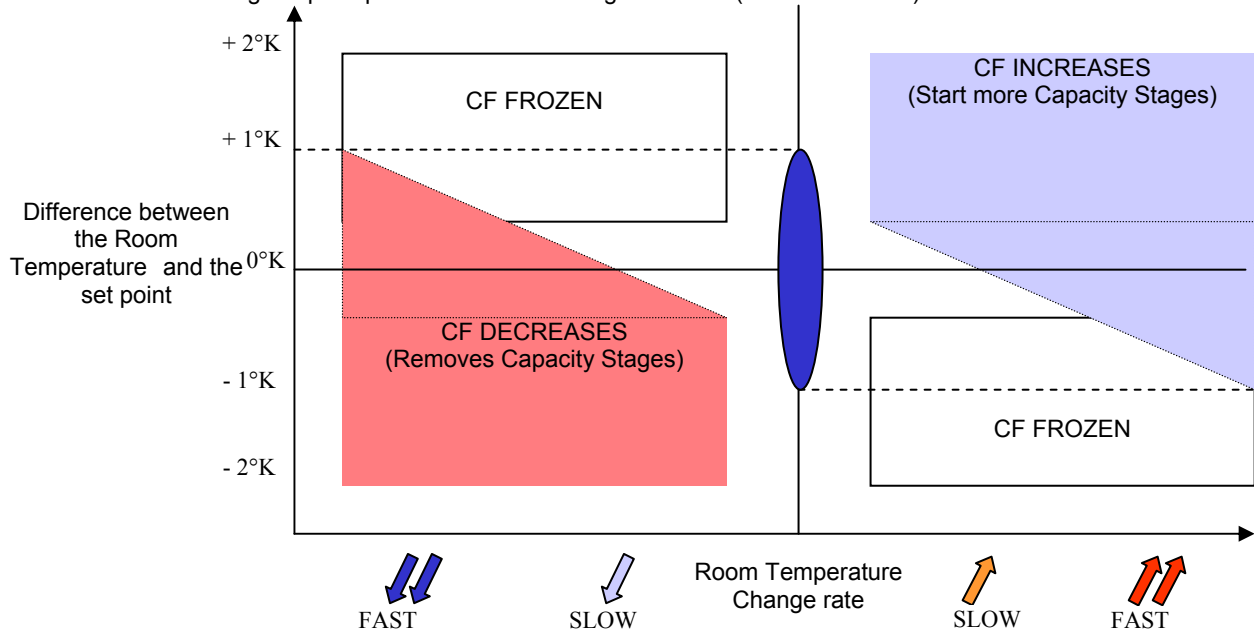

In order to anticipate, the reference point is recalculated each time the difference between air temperature and set point reach a minimum or a maximum.

The rate of change of the Capacity Factor (CF) is determined by another parameter called “REACTIVITY” and which value is in: % of CF / °C (Diff vs Set point) / min

- 3361 → REACTIVITY for the cooling mode.
- 3362 → REACTIVITY for the heating mode.
- 3363 → REACTIVITY for the fresh air reheating mode

- For the option of control humidity
- 3364 → REACTIVITY for the dehumidification mode.
  - 3365 → REACTIVITY for the humidification mode.

### Permutation, Cold or Heat Mode (Change-Over ; optional)

The choice of the operating mode in cooling or heating is automatically carried out according to the room temperature and the temperature set points adjustment.

Meanwhile as an option, using free contacts on parametric inputs, it is possible to disable one mode or another. (see Customized Input / Output (BE.50))

- With a free contact on [Sw Dis.Cool] The contact closing will disable the cooling mode.
- With a free contact on [Sw Dis.Heat] The contact closing will disable the heating mode.

# FRESH AIR DAMPER - Free-Cooling

## Function

Ensure a minimum fresh air introduction into the room and/or a free-cooling, thus reducing electric consumption.

## Description

### MINIMUM FRESH AIR

#### Adjustment by set point

The fresh air rate is adjustable by set point.

3312 → Minimum opening of the fresh air damper, %, adjustment by zone.

#### Adjustment by free contacts (optional)

With the customized free contacts, the fresh air rate can be adjusted. (see Customized Input / Output (BE.50))

- With a free contact on [0% F.A.] The contact closing will close completely the damper.
- With a free contact on [100% F.A.] The contact closing will open completely the damper.
- With a free contact on [10% F.A.], [20% F.A.], [30% F.A.], [40% F.A.] or [50% F.A.] The contact closing will open the damper to the mentioned rate.

If several contacts are customized with this functionality, the air damper will open according to the sum value of all closed contacts.

In any case, the minimum fresh air rate will be fixed according to the highest value between the set point and the request by contacts.

#### Adjustment by external signal (optional)

The minimum fresh air can be remotely modified by a signal 4-20mA. (See Customized Input / Output (BE.50))

For a signal of 4 mA applied on [F.A Offset] the threshold is set to 0%

For a signal of 20 mA applied on [F.A Offset] the threshold is set to 100%

A linear rule is applied between the two limits.

#### Air quality sensor, CO<sup>2</sup> (optional)

If a CO<sup>2</sup> sensor is connected to the unit, the minimum value of fresh air is calculated according to the CO<sup>2</sup> rate.

This functionality can be activated, or not, within the 4 day zones.

Two opening mode may be selected:

- Fresh air damper opening between 0% and the minimum fresh air set point [0-Min]

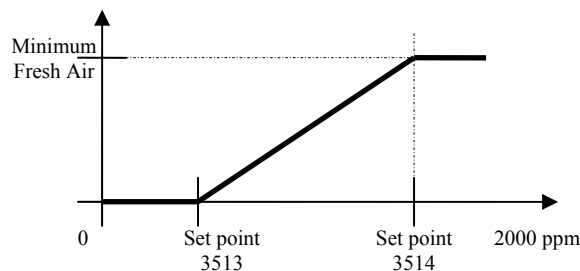

- Fresh air damper opening between the minimum fresh air set point and the maximum fresh air set point. [Min-max]

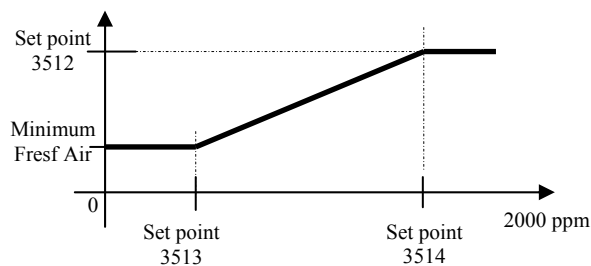

- 2132 → CO<sup>2</sup> rate measured value of the (ppm).
- 3354 → CO<sup>2</sup> function authorization, adjustment by zone.
- 3515 → CO<sup>2</sup> function mode [0-Min], [Min-Max].
- 3513 → CO<sup>2</sup> rate (ppm), threshold until which the 0% or the minimum fresh air is maintained.
- 3514 → CO<sup>2</sup> rate (ppm), threshold from which the minimum fresh air or the 100% is used.
- 3512 → Maximum fresh air damper opening.

### **Fresh air damper Calibration**

The real fresh air volume introduced into the system is not always proportional to the damper opening percentage. That is particularly true when the return air duct system is sized to give excessive pressure losses. It results with excessive fresh air input, and thus with an increase of the system exploitation costs. From now on, it is possible to calibrate the fresh air using three temperature probes: one in the blowing section, another in the return air and the last one in the outdoor temperature.

Using these three probes, Climatic™50 calculates and memorizes the exact percentage of fresh air for each position of the damper.

$$\text{Blowing } T^{\circ} = \text{Return } T^{\circ} \times \% \text{Return Air} + \text{Fresh air } T^{\circ} \times \% \text{Fresh Air}$$

This adjustment sequence takes place periodically when all heating and cooling elements are off.

- 3516 → Fresh air damper calibration authorization.

## **FREE COOLING**

From a room temperature need (Capacity Factor) the damper opens according to a proportional rule on the blowing temperature.

0% need = Minimum fresh air.

100% need = low limit threshold (3373) + 2K

The user may choose to limit the fresh air damper operation with contacts or set points modification (see minimum fresh air § above). The outdoor temperature or humidity value may also limit the opening.

### **Outdoor temperature**

The Free-Cooling is stopped if the outside temperature is higher than the return or room temperature.

The Free-Cooling is stopped if the outside temperature is lower or higher than the threshold defined in set point (3511).

Free cooling is forbidden on high limit for a set point adjustment over +20.0°C.

Free cooling is forbidden on low limit for a set point adjustment lower than +20.0°C.

### **Outdoor humidity (optional)**

If humidity control option is selected, the Free-cooling is stopped if the external absolute humidity (water weight) is higher than the indoor absolute humidity.

### **Set point**

The Free-Cooling is stopped if the set point (3353) is No

### **Free contact (optional)**

Stop of Free-Cooling by closing customized free contacts. (See minimum fresh air § above)

[0% A.N.] = the register of air is completely closed.

[100% A.N.] = the register of air is completely open.

- 3353 → Economiser function authorization, adjustment by zone.
- 3373 → Low limit blowing temperature threshold.
- 3511 → Outdoor temperature threshold for authorization of the economiser function.
- 3512 → Maximum fresh air damper opening

# COMPRESSORS

## Function

From a room temperature need (Capacity Factor) the compressors are started and stopped with a determined sequence in order to minimize the anti short cycle protection effect and to equalize the operating time.

## Description

### **Compressors Start/Stop sequences.**

This sequence is set by the memorized compressor operating time and it also includes the other compressors back-up function, if they are not available. For circuits with tandem compressors, it is possible to favour the unit performance, COP, rather than the compressor operating time balance (3642).

The compressor starts if all the following conditions are satisfied:

- The unit, the compressor and the circuit do not have major faults.
- The control requires the starting of the compressor.
- The compressor has the lowest operating time among the stand by compressors.
- The compressor has not been brought into service for at least 6 minutes.

Every compressor state can be checked on the following menus: 2512, 2522, 2532..., 2562

To check the operating time of each compressor use menus: 2519, 2529....2569

To reset an operating time counter, put the DS50 cursor on the line and press the key 'Enter' during 20 seconds.

### **Compressor operation authorization.**

The user may choose to limit the operation of the compressors by using contacts or set points modification.

#### **Outdoor temperature**

##### **Cooling mode**

Stop of all compressors if the outdoor temperature is lower than the threshold (3612)

Stop of 50% of the compressors if the outdoor temperature is lower than the threshold (3611)

Note: if the option 'Low Ambient Kit' is activated (3822) these two functionalities are disabled.

##### **Heating mode (Heat pump)**

Stop of all compressors if the outdoor temperature is higher than the threshold (3613)

#### **Set points**

Stop of one or several compressors if the compressor number is not displayed in the address (3641)

##### **Cooling mode**

Stop of all compressors if the instruction (3355) is set to [No]

Limitation to 50% of the compressors if the instruction (3359) is set to [Yes]

Immediate stop of 50% of the compressors if the instruction (3643) is set to [Yes]

##### **Heating mode (Heat pump)**

Stop of all the compressors if the instruction (3356) is set to [No]

Note: Address 3355 and 3356 can be set differently for zones A, B, C, Uno or BMS

Note: The address 3359 can be set differently for zones Uno or BMS

### **Free contacts (Optional - See Customized Input / Output (BE.50))**

Stop of one or several compressors if the compressor number is not displayed in the address (3641)

Stop of 50% of the compressors if the contact [Dis. 50%Cp] is close.

Stop of all the compressors if the contact [Dis. Cp/Ah] or [Dis. Comp] is close.

### **High pressure offloading (FLEXY 2 tandem only)**

With tandem compressors, it is possible to reduce the circuit capacity by stopping one of the two compressors before the high pressure reaches its limits in order to keep a partial capacity with high outdoor temperature.

If the condensing pressure is higher than 40b and continuously increases with all the fans in operation at full speed, 1 compressor of the considered circuit is stopped.

- 3355 → Compressors authorization in cooling mode, adjustment by zone.
- 3356 → Compressors authorization in heating mode, adjustment by zone.
- 3359 → Limitation to 50% of the compressors, in Unoccupation and BMS mode.
- 3611 → Low outdoor temperature threshold for limitation to 50% of the compressors, in cooling mode
- 3612 → Low outdoor temperature threshold for stopping all compressors in cooling mode.
- 3613 → High outdoor temperature threshold for stopping all compressors in heating mode..
- 3641 → Compressors authorization.
- 3642 → Rotation mode choice.
- 3643 → Off loading of 50% of the compressors.

# DEFROST – Heat Pump

## Function

Avoid the evaporator icing (external coil) in heat pump operation in winter time.

## Description

To avoid the icing of the external air exchanger in winter operation, it is necessary to reverse the refrigerant cycle on a regular basis to de-ice by heating the exchanger.

The defrost is activated when the air temperature is under a set point (3422)

When defrost is demanded, the sequence is as following:

1. Pre-heating of supplementary heating elements during 1 minute (Option)
2. Stop compressors and fans
3. Reverse 4 way valve
4. Start compressors.
5. When the fans are started several times (3625) or if compressors are in operation for more than 6 minutes, stop the compressors.
6. Reverse 4 way valve
7. End of defrost

Two different type of Defrost demand are possible.

- Dynamic defrost (set point 3621 = Dynamic)
- Cycling defrost (set point 3621 = Cyclic)

### Cycling defrost

The unit will start a cyclic defrost under a regular period of time (instruction 3624)

### Dynamic defrost

This allows the unit to start the defrost cycle only when required. This is achieved through the measurement of the temperature difference between the coil and the outdoor. The defrost will be initiated shortly after the Climatic50 has located the largest gradient in the curve.

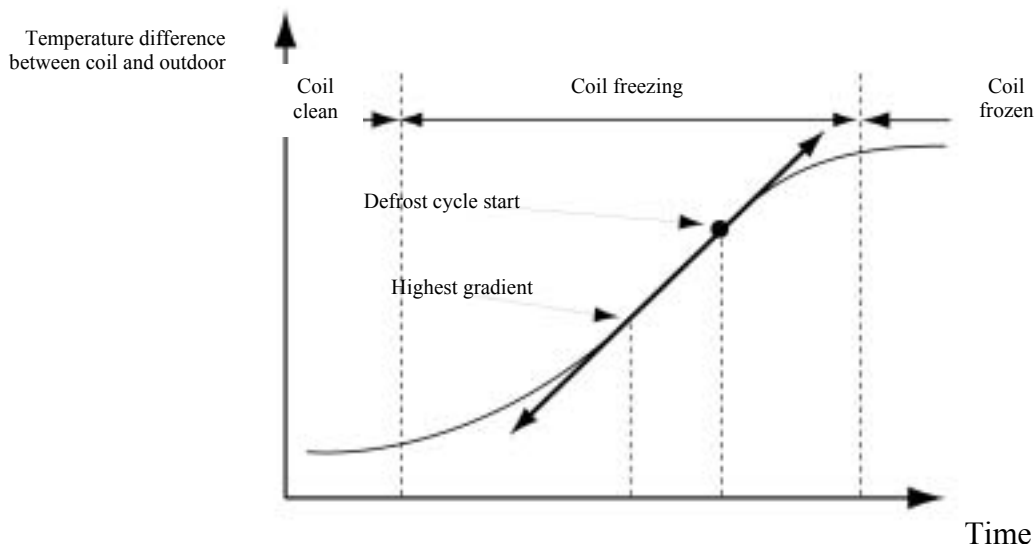

**3621** → Defrost mode.

**3622** → Outside air temperature under which the defrost cycle is activated.

**3623** → LP temperature under which the defrost cycle is activated for the cyclic mode and defrost cycle activation sensibility for the dynamic mode (standard ratio between dry coil  $\Delta T$  and iced coil  $\Delta T$ ).

**3624** → Minimum compressors operating time between 2 defrosts

**3625** → Number of fans Restart operations according to the pressure.



# SUPPLEMENT OF HEATING (Option)

## Fonction

Units may be equipped with 3 types of supplementary heating:

Gas (BG, FG et BD, FD)

Hot water coils (BC, FC et BH, FH)

Electric heaters (BC, FC et BH, FH)

From a room temperature need (Capacity Factor) the supplement of heating stages are started and stopped with a pre-determined order.

## Description

### **Operation priority, Compressors / Additional heating**

From factory setting, in heat pump mode, Climatic™ starts compressors first and then if necessary, starts additional heating.

This sequence may be reversed with set points for the ambient temperature regulation and for fresh air pre-heating.

**3324** → Priority inversion from compressors to supplementary heating, air temperature regulation, adjustment by zone.

**3332** → Priority inversion from compressors to supplementary heating, fresh air regulation, adjustment by zone.

### **Operation authorization**

The user may choose to limit the operation of the compressors by using contacts or set points modification.

#### **Set points**

Stop of additional heating if the set point (3357) is set to 'No'.

Note: The address (3357) can be set differently for zones A, B, C, Ino ou GTC

#### **Contact**

Stop of the gaz module if the free contacts [Dis. Cp/Ah] or [Dis. AuxH.] are closed. (See Customized Input / Output (BE.50)).

**3357** → Supplementary heating authorization adjustment by zone.

## ELECTRICAL HEATERS

Electrical heaters are stopped if the outside temperature is above a threshold in set point (3721).

The capacity of electrical heaters piloted by a Triac may be limited. The set point (3723) fixes the maximum threshold.

For electrical heaters piloted by a Triac and positioned before the coil, if the mixing air temperature is below the threshold in set point (3722), the electrical heaters are activated to 100%.

For electrical heaters piloted by a Triac and positioned after the coil, if the blowing air temperature is below the threshold in set point (3722), the electrical heaters are activated to 100%.

Pour les résistances électrique pilotées par Triac et positionnées après la batterie de détente directe ; si la température de soufflage est inférieure au seuil de la consigne 3722 les résistances sont activées à 100%

**3721** → Outside air temperature threshold for electrical heaters authorization.

**3722** → Minimum temperature threshold, Triac.

**3723** → Maximum capacity threshold, Triac.

## HOT WATER

### **Protection against freezing with minimum water flow.**

If the outside air temperature is below the set point (3331), the valve will open to a minimum fixed in the threshold (3332).

#### **Freezing fault**

In general, in case of detection of hot water coil icing, the valve will open to 100%. Due to certain hydraulic network, pumps or tracing, the coil protection is done by closing the valve. This can be activated with the set point 3733.

**3731** → Outside air temperature threshold for authorization, minimum water flow.

**3732** → Valve opening threshold , minimum water flow.

**3733** → Valve action in case of freezing fault.

## **HOT WATER CIRCULATOR**

The Climatic may drive a circulator for the hot water hydraulic circuit.

The activation mode of the circulator must be determined according to the circuit.

**3741** → Circulator operating mode.

[No]	No circulator
[Frost.Al.]	Circulator activation in case of freezing fault
[Start Heat.]	Circulator activation in heating mode for air temperature regulation.
[Started]	Circulator activation as soon as the blowing fan is activated.

# CUSTOMIZED INPUT/OUTPUT

## Function

On the BM.50 card and with the optional expansion board BE.50, it is possible to customize some input / output for remote control of the unit. So it is possible to customize

- 5 digital outputs NC or NO set up with parameters 3841, 3842, 3843 and 3845
- 6 digital inputs set up by parameters 3851, 3852, 3853 and 3854
- 4 analogical inputs (4-20mA or Lennox NTC temperature probe), set up with parameters 3861, 3862, 3863 et 3864

## Description

Il est possible de paramétrer les fonctions suivantes :

### SORTIE DIGITALE NC ou NO - CONTACTS SECS

Following information could be recovered from each contact :

[Not Used.]	No contact
[Filter Al.]	Filter fault
[Blower Al.]	Blowing fan fault
[Comp. Al.]	Compressor fault
[Gas Al]	Gaz fault
[ElecH. Al]	Electrical heater fault
[Frost. Al]	Alarm, freezing risk
[Smoke. Al.]	Smoke detector alarm
[Heat. Mode]	Heating mode
[Humidif.]	Humidifier pilote
[Z:A]	Unit operating Mode A
[Z:B]	Unit operating Mode B
[Z:C]	Unit operating Mode C
[Uno]	Unit operating Mode Inoccupied
[Bms]	Unit operating Mode BMS
[LibrFree]	Free for BMS acting
[Exhaust 1]	Drive exhaust fan n°1
[Exhaust 2]	Drive exhaust fan n°2
[Exhaust 3]	Drive exhaust fan n°3

**3841** → Setting of connector BM50-J17-N12.

**3842** → Setting of connector BE50-J5-N1.

**3843** → Setting of connector BE50-J6-N2.

**3844** → Setting of connector BE50-J7-N3.

**3845** → Setting of connector BE50-J8-N4.

### ENTREE DIGITALE 24V AC ou DC

following orders can be sent on each contact:

[Not Used]	No contact
[Sw Unoc.]	Force Unoccupied Mode
[Dis. Cp/AH]	Stop of all compressors and auxillary heating
[Dis. Comp. ]	Stop of all compressors
[Dis. 50%Cp]	Immediate stop of 50% of the compressors
[Dis. AuxH.]	Stop of supplementary heating
[Sw Dis. Cool]	Cancellation of cooling mode
[Sw Dis. Heat]	Cancellation of heating mode
[State Humi]	Humidifier fault input
[0% F.A. ]	Force 0% fresh air
[10% F.A.]	Add 10% fresh air
[20% F.A. ]	Add 20% fresh air
[30% F.A.]	Add 30% fresh air
[40% F.A.]	Add 40% fresh air
[50% F.A.]	Add 50% fresh air
[100% F.A.]	Force 100% fresh air
[Low Speed]	Force low speed ventilation
[Free]	Free for BMS system information.

- 3851 → Setting of connector BM50-J8-ID13.
- 3852 → Setting of connector BM50-J8-ID14.
- 3853 → Setting of connector BE50-J4-ID1.
- 3854 → Setting of connector BE50-J4-ID2.
- 3855 → Setting of connector BE50-J4-ID3.
- 3856 → Setting of connector BE50-J4-ID4.

## **ENTREE ANALOGIQUE**

It is possible to make the following actions:

[Not Used]	Not used
[S.P Offset]	Ambient temperature set point offset – 4-20mA signal.
[F.A Offset]	Minimum fresh air set point – 4-20mA signal.
[Weather T.]	Entry for a Meteo temperature sensor
[Weather H.]	Entry for a meteo humidity sensor
[Free NTC]	Free temperature probe connection
[Free Hr.]	Free relative humidity sensor connection

### ***Ambient temperature set point offset – 4-20mA signal:***

The 4-20mA signal sent to the unit is linearly converted using a -5K to +5K range of temperature set point.

For example: for a unit set point of 20°C

A 4mA signal will give a 15°C unit temperature set point

A 20mA signal will give a 20°C unit temperature set point

A 20mA signal will give a 25°C unit temperature set point

### ***Minimum fresh air set point – 4-20mA signal:***

The 4-20mA signal sent to the unit is linearly converted to a 0% - 100% fresh air damper opening request.

### ***Entry for a Meteo temperature sensor:***

The 4-20mA signal sent to the unit is linearly converted using a -40°C to +80°C range, this measure will replace the one given by the unit sensor.

### ***Entrée d'une sonde météo, en humidité :***

The 4-20mA signal sent to the unit is linearly converted using a 0% to 100% range, , this measure will replace the one given by the unit sensor.

### ***Free temperature probe connection:***

Lennox NTC sensor. The measured value will be displayed on following addresses 2161, 2162, 2163 or 2164.

### ***Free relative humidity sensor connection:***

The 4-20 mA signal sent to the unit is linearly converted using a 0% to 100% range. The measured value will be displayed on following addresses 2165, 2166, 2167 or 2168.

- 3861 → Setting of connector BE50-J9-B1.
- 3862 → Setting of connector BE50-J9-B2.
- 3863 → Setting of connector BE50-J10-B3.
- 3864 → Setting of connector BE50-J10-B4.

# ERROR CODES

<b>001</b>	"Airflow"
<b>004</b>	Filters, Clogged up
<b>005</b>	Filters, Missing
<b>011</b>	Electric heating elements
<b>012</b>	High Temperature, Blowing
<b>013</b>	Low Temperature, Ambient
<b>014</b>	Gas burner, 1
<b>015</b>	Gas burner, 2
<b>022</b>	Low Temperature, Blowing
<b>023</b>	High Temperature, Ambient
<b>031</b>	Humidifier
<b>032</b>	Low Humidity, Ambient
<b>033</b>	High Humidity, Ambient
<b>041</b>	Pump
<b>070</b>	Clock card
<b>071</b>	BE50
<b>081</b>	Temperature sensor, Ambient
<b>082</b>	Humidity sensor, Ambient
<b>083</b>	Temperature probe, Outside
<b>084</b>	Humidity sensor, Outside
<b>085</b>	Temperature probe, Blower
<b>086</b>	Circuit 1, Temperature sensor, Water condenser Outlet
<b>087</b>	Circuit 2, Temperature sensor, Water condenser Outlet
<b>088</b>	Temperature sensor, return or Mixing air
<b>091</b>	Treatment Fan
<b>092</b>	Circuit 1, Condenser fan
<b>093</b>	Circuit 2, Condenser fan
<b>094</b>	Circuit 3, Condenser fan
<b>095</b>	Circuit 4, Condenser fan
<b>096</b>	Low temperature, Water Condenser
<b>097</b>	High temperature, Water Condenser
<b>098</b>	Flow rate, water condenser
<b>099</b>	Smoke detector
<b>111</b>	Circuit 1, Probe or Sensor
<b>115</b>	Circuit 1, High pressure or electrical protection
<b>117</b>	Circuit 1, Low pressure
<b>121</b>	Circuit 2, Probe or Sensor
<b>125</b>	Circuit 2, High pressure or electrical protection
<b>127</b>	Circuit 2, Low pressure
<b>131</b>	Circuit 3, Probe or Sensor
<b>135</b>	Circuit 3, High pressure or electrical protection
<b>137</b>	Circuit 3, Low pressure
<b>141</b>	Circuit 4, Probe or Sensor
<b>145</b>	Circuit 4, High pressure or electrical protection
<b>147</b>	Circuit 4, Low pressure

# Insufficient airflow

Error code: 001

## Description

The pressure differential between the treatment unit and the filters is small although the fan has been running for more than 3 minutes.

$\Delta p <$  safety threshold for more than 20 seconds

2131 →  $\Delta p$ .

3411 → Safety threshold

## Action

- ☞ Immediate shutdown of the complete unit.
- ☞ Fault signalling.  
If a DS50 is connected to the unit; Memorisation and display of all faults  
Otherwise; Memorisation and display of the 3rd daily fault only.

## Reset

The unit restarts automatically 2 minutes after making safe.

The fault will no longer be reset automatically after 3 cut outs in the same day and must be reset manually.

Note: The fault counter is cleared and reset every day at 11 am, provided the maximum number of faults has not been reached.

Possible causes	Solving the problem
Air system obstructed or closed	Check the system
Broken belts	Replace the belts
Problem with the fan wiring	Check the connections
Problem with the pressure transmitter wiring	Check the connections
Incorrect setting of the safety threshold	Check the settings

# Filters Clogged or Missing

Error code: 004, 005

## Description

The pressure differential between the treatment unit and the filters is small although the fan has been running for more than 3 minutes.

Filters missing:  $\Delta p < \text{safety threshold}$  for more than 1 minute  
 Clogged filters:  $\Delta p > \text{safety threshold}$  for more than 1 minute

- 2131 →  $\Delta p$ .
- 3412 → Safety threshold, filters missing.
- 3413 → Safety threshold, blocked filters.

## Action

- ☞ No safety.
- ☞ Fault signalling. Memorisation is displayed
- ☞ Display of fault.
  - 004, Filters clogged
  - 005, filters missing

## Reset

Automatic reset of the fault as soon as the pressure returns to the authorized operating range.

Possible causes	Solving the problem
Filters removed and not replaced	Fit new filters
Filters clogged	Clean or replace the filters
Problem with the pressure transmitter wiring	Check the connections
Incorrect setting of the safety thresholds	Check the settings

# Ambient Temperature and Humidity, Outside Limits

Error code: 013, 023, 032, 033

## Description

The ambient temperature or humidity of the air measured by the sensor is outside the permitted range.

Lower limit of ambient temperature: Ambient temperature < safety threshold

Upper limit of ambient temperature: Ambient temperature > safety threshold

Lower limit of ambient humidity: Ambient humidity < safety threshold

Upper limit of ambient humidity: Ambient humidity > safety threshold

2112 → Ambient temperature

3371 → Safety threshold, lower limit of ambient temperature

3372 → Safety threshold, upper limit of ambient temperature

2122 → Ambient humidity

3378 → Safety threshold, lower limit of ambient humidity

3379 → Safety threshold, upper limit of ambient humidity

## Action

- ☞ No safety.
- ☞ Fault signalling. Memorisation is displayed
- ☞ Display of fault.
  - 013, Lower limit of ambient temperature.
  - 023, Upper limit of ambient temperature.
  - 032, Lower limit of ambient humidity.
  - 033, Upper limit of ambient humidity.

## Reset

Automatic resetting of fault as soon as the temperature or humidity returns within the permitted operating range.

Possible causes	Solving the problem
Temperature probe or humidity sensor failed	Replace probe or sensor.
Problem with wiring of probe or sensor	Check the connections of the probe or sensor



# Blowing temperature, outside limits

Error code: 012, 022

## Description

The temperature of the blown air measured by the sensor is outside the permitted range or the hot water system frost thermostat is activated.

Lower blower temperature limit: Blower temperature < safety thresholds  
 Upper blower temperature limit: Blower temperature > safety thresholds

- 2113 → Ambient temperature
- 3373 → 1st safety threshold, lower blower temperature limit
- 3374 → 2nd safety threshold, lower blower temperature limit
- 3375 → 3rd safety threshold, lower blower temperature limit
- 3376 → 1st safety threshold, upper blower temperature limit
- 3377 → 2nd safety threshold, upper blower temperature limit

## Action

- ☞ 1st lower limit safety threshold:  
 One compressor stops immediately, then the others progressively.  
 Fresh air regulator set to minimum opening.
- ☞ 2nd lower limit safety threshold:  
 All compressors stop.  
 Fresh air regulator closes.
- ☞ 3rd lower limit safety threshold or activation of frost thermostat:  
 If there is a hot water unit; the complete unit stops immediately.  
 Otherwise; the unit stops after 15 minutes.
- ☞ 1st upper limit safety threshold:  
 One compressor or back-up heating stage stops immediately, then the others progressively.
- ☞ 2nd lower limit safety threshold:  
 All the compressors and all the back-up heating stages stop.
- ☞ Fault signalling. Memorisation is displayed.
- ☞ Display of fault.  
 012, 2nd upper blower temperature limit threshold.  
 022, 3rd lower blower temperature limit threshold or activation of frost thermostat.

## Reset

Automatic resetting of fault as soon as the temperature returns to within the permitted operating range, except 3rd safety threshold lower limit which requires a manual reset.

Possible causes	Solving the problem
Insufficient airflow	Check the air system
Air damper jammed open	Check the air damper, mechanically and electrically
Frost safety thermostat activated	Manually reset the pressure switch
Probe failure.	Replace the probe.
Wiring problem with the probe	Check the probe connections

# Overheating of Electrical Heating Elements

Error code: 011

## Description

A safety thermostat in the electric heater unit has operated or the control contactor has not been activated.

## Action

- ☞ Heating elements switched off immediately.
- ☞ Fault signalling. Memorisation is displayed.

## Reset

Manual reset.

Possible causes	Solving the problem
Air system obstructed or closed	Check the system
Filters clogged	Clean the filters
Broken belts	Replace the belts
Problem with the wiring of the heating elements	Check the connections

# Gas Burner Faults

Error code: 014, 015

## Description

The gas burner control box has generated a fault and is no longer controlling the fume extractor fan.

## Action

- ☞ The gas burner shuts down immediately.
- ☞ Fault signalling.  
If a DS50 is connected to the unit; Memorisation and display of all faults.  
Otherwise; Memorisation and display only of the 3rd daily fault.
- ☞ Display of fault.  
014, 1st gas burner.  
015, 2nd gas burner

## Reset

The burner restarts automatically 2 minutes after safety setting by electrically resetting the burner control box.

The fault will no longer be reset automatically after 3 cutouts in the same day and must be reset manually.

Note: The fault counter is cleared and reset every day at 11 am, provided the maximum number of faults has not been reached.

Possible causes	Solving the problem
See IOM Flexy	Read the documentation
Problem with the wiring of the gas burners	Check the connections

## External Humidifier fault

Error code: 031

### Description

A switch outside the unit reports a fault associated with a humidifier.

### Action

- ☞ The humidifier controller stops immediately.
- ☞ Fault signalling. Memorisation is displayed.

### Reset

The humidifier controller restarts automatically when the switch closes.

Possible causes	Solving the problem
Problem with the external humidifier	Check the humidifier

## Hot Water Circulator Fault

Error code: 040

### Description

The electrical protection of the circulator has operated.

### Action

- ☞ The circulator stops immediately.
- ☞ Fault signalling. Memorisation is displayed.

### Reset

Manual reset.

Possible causes	Solving the problem
Problem with the circulator	Check the wiring

## Fault in Real Time Clock

Error code: 070

### Description

The real time clock card, incorporated in the Climatic™ card, is defective.

### Action

☞ Fault signalling. Memorisation is displayed.

### Reset

Automatic reset.

Possible causes	Solving the problem
The battery is exhausted	Replace the daughter card
The daughter card is not inserted correctly	Check the connection

## Extension card fault (BE50)

Error code: 071

### Description

Communication between the BM50 and the BE50 is down.

### Action

- ☞ Compressors 3 and 4 stop, for the Flexy range.
- ☞ Fault signalling. Memorisation is displayed.

### Reset

The fault disappears automatically as soon as communication is reestablished.

Possible causes	Solving the problem
Incorrect addressing of the BE50	Configure the Serial Address dip-switches (on, off, off, off)
BM50 or BE50 damaged	Replace the defective component
Problem with the BIOS	Replace the BIOS with version 3A.57 or 3.64 or above
Incorrect wiring or loose connection between BM50 and BE50	Check connections and wiring

# Faulty Probes and Sensors

Error code: 081, 082, 083, 085, 086, 087, 088, 111, 121, 131, 141

## Description

One or more temperature probes or pressure sensors in the cooling systems or elsewhere are short circuited, cut or disconnected.

## Action

- ☞ Blowing or outside ambient temperature:  
The compressors and additional heaters shut down, ventilation remains.
- ☞ Temperature or pressure for circuit:  
All compressors in the circuit shut down.
- ☞ Fault signalling. Memorisation is displayed.
- ☞ Display of fault.
  - 081, Temperature sensor; Ambient.
  - 082, Humidity sensor; Ambient.
  - 083, Temperature sensor; Outside.
  - 085, Temperature sensor; Blowing
  - 086, Temperature sensor; Outlet 1 of condensation heat exchanger.
  - 087, Temperature sensor; Outlet 2 of condensation heat exchanger.
  - 088, Temperature sensor; Return air.
  - 111, Temperature sensor or pressure probe; Circuit 1.
  - 121, Temperature sensor or pressure probe; Circuit 2.
  - 131, Temperature sensor or pressure probe; Circuit 3.
  - 141, Temperature sensor or pressure probe; Circuit 4.

## Reset

The unit returns to normal operation after the signal from the faulty probes or sensors is re-established.

Possible causes	Solving the problem
Damaged probes or sensors	Replace probe or sensor
Incorrect wiring or loose connection on a probe or sensor	Check probe and sensor connections and wiring

## Blowing fan

Error code: 091

### Description

The air conditioning fan motor control is no longer active.

### Action

- ☞ The unit stops immediately.
- ☞ Fault signalling. Memorisation is displayed.

### Reset

Manual reset.

Possible causes	Solving the problem
Fire safety thermostat active	Reset the thermostat
Motor thermal protection devices activated	Check the air system
Motor thermal protection devices activated	Check the motors
Problem with the fan wiring	Check the connections

## Condenser fans

Error code: 092, 093, 094, 095

### Description

The condenser fan motor control is no longer active.

### Action

- ☞ The compressors and fans in the circuit shut down immediately.
- ☞ Fault signalling.  
If a DS50 is connected to the unit; Memorisation and display of all faults.  
Otherwise; Memorisation and display only of the 3rd daily fault.
- ☞ Display of fault.
  - 092, Fan; Circuit 1.
  - 093, Fan; Circuit 2.
  - 094, Fan; Circuit 3.
  - 095, Fan; Circuit 4.

### Reset

The safety device is automatically cancelled 30 minutes after activation.

The fault will no longer be reset automatically after 3 cutouts in the same day and must be reset manually.

Note: The fault counter is cleared and reset every day at 11 am, provided the maximum number of faults has not been reached.

Possible causes	Solving the problem
Motor thermal protection devices activated	Check the air system
Motor thermal protection devices activated	Check the motors
Problem with the fan wiring	Check the connections



# Water Condenser Faults

Error code: 096, 097, 098

## Description

The water outlet temperature from the heat exchanger measured by the sensor is outside the permitted range or the water flow detection device is not active.

Lower temperature limit: Water outlet temperature < safety threshold  
 Upper temperature limit: Water outlet temperature > safety threshold

- 2572 → Temperature of circuit 1
- 2573 → Temperature of circuit 2
- 3631 → Safety threshold, lower limit of water output temperature
- 3632 → Safety threshold, upper limit of water outlet temperature

## Action

- ☞ Immediate shut down of compressors.
- ☞ Fault signalling.  
 If a DS50 is connected to the unit; Memorisation and display of all faults.  
 Otherwise; Memorisation and display only of the 3rd daily fault.
- ☞ Display of fault.
  - 096, Lower limit.
  - 097, Upper limit.
  - 098, Insufficient water flow in condenser.

## Reset

Automatic reset of the fault as soon as the temperature returns to the permitted operating range.

The fault will no longer be reset automatically after 3 cutouts in the same day and must be reset manually.

Note: The fault counter is cleared and reset every day at 11 am, provided the maximum number of faults has not been reached.

Possible causes	Solving the problem
Damaged probes or sensors	Replace probe or sensor
Incorrect wiring or loose connection on a probe or sensor	Check probe and sensor connections and wiring

# Smoke Detector

Error code: 099

## Description

The stand-alone detector switch (DAD) checking for the presence of smoke in the unit is activated.

## Action

- ☞ Immediate shutdown of the unit and opening of the fresh air controller.
- ☞ Fault signalling. Memorisation is displayed.

## Reset

Manual reset.

Possible causes	Solving the problem
Problem with the DAD wiring	Check the connections

# Compressors shut down on LP Cutoff

Error code: 117, 127, 137, 147

## Description

The low pressure switch of the circuit has been open for 2 minutes, while one compressor in the Circuit has operated for 2 minutes.  
 The low pressure switch of the Circuit has been open for 1 hour.

## Action

- ☞ Immediate shut down of the compressors in the circuit.
- ☞ Fault signalling.
  - If a DS50 is connected to the unit; Memorisation and display of all faults.
  - Otherwise; Memorisation and display only of the 3rd daily fault.
- ☞ Display of fault.
  - 117, Circuit 1.
  - 127, Circuit 2.
  - 137, Circuit 3.
  - 147, Circuit 4.

## Reset

Automatic reset of the fault as soon as the low pressure becomes greater than the safety pressure switch cutoff limit

The fault will no longer be reset automatically after 3 cutouts in the same day and must be reset manually.

Note: The fault counter is cleared and reset every day at 10 am provided the maximum number of faults has not been reached.

Possible causes	Solving the problem
Not enough refrigerant in the circuit	Adjust the refrigerant charge
Faulty expansion valve	Check that the expansion valve is operating correctly
Filter drier blocked	Replace the filter drier
Faulty low pressure switch	Replace the low pressure switch

## **The compressors shut down on HP Cutoff or Electrical Protection**

Error code: 115, 125, 135, 147

### **Description**

During start up or operation of a compressor:  
 The HP pressure switch of the Circuit is open.  
 The internal protection of a compressor in the Circuit has tripped.  
 The flow thermostat of a compressor in the Circuit has tripped.

### **Action**

- ☞ Immediate shut down of the compressors in the circuit.
- ☞ Fault signalling.
  - If a DS50 is connected to the unit; Memorisation and display of all faults.
  - Otherwise; Memorisation and display only of the 3rd daily fault.
- ☞ Display of fault.
  - 115, Circuit 1.
  - 125, Circuit 2.
  - 135, Circuit 3.
  - 145, Circuit 4.

### **Reset**

The safety device is automatically cancelled 30 minutes after activation.

The fault will no longer be reset automatically after 3 cutouts in the same day and must be reset manually.

Note: The fault counter is cleared and reset every day at 10 am provided the maximum number of faults has not been reached.

Possible causes	Solving the problem
Dirty condenser	Clean the condenser
Fan out of order	Replace the fan
Incorrect wiring of the high pressure switch	Check the wiring of the high pressure switch
Dirty filter drier	Replace the filter drier

# COMMUNICATION

## MASTER/SLAVE

### Function

Link several units in order to allow a "Master/Slave" relationship between each units.

### Description

#### ***Configuration of the pLan network***

To configure the addresses of the cards for the pLan network, see chapter: (Configuring the pLan address of the BM50)

For the pLan network, each unit must have a different address:

Unit 1 → Master unit  
Units 2 to 12 → Slave units

#### ***Master/Slave Modes***

Several master/slave modes are available and may be configured by using set points 3922 and 3923:

#### ***Cold/hot Master/Slave mode:***

All the units are stand-alone, but:

- If the master is calling for cooling, the heating adjustment of the slaves is inhibited.
- If the master is calling for heating, the cooling adjustment of the slaves is inhibited.

#### ***"Token" Mode:***

This mode limits the number of compressors in operation.

Use set point 3922 to set the maximum number of compressors that can operate simultaneously for all the units connected.

#### ***Back-up mode:***

The unit with the highest pLan address is used as a back-up in the event of a fault in another unit.

In the event of different faults on several units, the following fault priority is applied:

1. The unit stops
2. Fault in one sensor or probe
3. Fault in one or more compressors
4. Fault in a back-up heater
5. Temperature Limit fault
6. Filter fault

If the ambient temperature is exceeded, fault 013 or 023, the back-up unit will restart to compensate for the loss of power of the other units.

#### ***Rotating back-up mode:***

Same as above, except the "back-up" unit changes every Tuesday at 09.00 if none of the other units is faulty.

#### ***Master DC50***

Function configurable using set point 3924:

Activation of this function enables one, and only one, DC50 to be connected for a maximum of 12 units.

- The DC50 must be connected to the Master unit (pLan address 1).
- The functions between the Master BM50 and its DC50 are standard.
- The Master BM50 communicates its Start or Stop status to its slaves, the current range and the values of its temperature and minimum fresh air set points.
- The slaves BM50s communicate a summary of their Alarms to the master. A 902 alarm on the master unit represents activation of a fault on slave unit 2 (903 for 3, etc).

This function is incompatible with the Back-up mode.

### **Reference Temperature, Humidity and CO<sub>2</sub>.**

Function may be configured using set points 3922, 3925, 3926 and 3927

The ambient temperature and humidity (set point 3925), the temperature and humidity of the external air (set point 3926) and/or the value of CO<sub>2</sub> (set point 3927) used for regulation can be determined from the following calculations:

[Not Used] → Each machine regulates with its own sensors

[M/S Temp] → Slave units regulate with the values of the Master unit probes or sensors

[M/S Aver.] → All the units regulate with the average of the values of the probes or sensors on the bus

To calculate the averages, the number of units connected must be entered in set point 3922

In all modes, each unit is independent for fault management.

**3921** → pLan address, see chapter: Configuring the pLan address of the BM50

**3922** → Number of cards connected or number of compressors desired

**3923** → Choice of function

[Not Used] None

[M/S C/H] Cooling/Heating Master/Slave Mode

[Token] Limiting the number of active compressors

[Backup] Back-up mode

[Rol.Backup] Back-up mode + weekly rotation

**3924** → Activation, Master DC50

**3925** → Choice of management of ambient temperatures and humidity

**3926** → Choice of management of outside temperatures and humidity

**3927** → Choice of management of air quality sensors

## **BMS**

### **Function**

This is used to link a Climatic™ to a BMS network for remote control of the unit.

### **Description**

The Climatic™ 50 can communicate using various protocols:

- MODBUS protocol for connection with KP06 (see specific KP06 manual) or other Lennox communication products (3932 = Modbus)
- MODBUS protocol (3932 = Modbus)
- LONWORKS system (3932 = LonWorks)
- BACNET system (3932 = Bacnet)
- TREND system (3932 = Trend)
- ADALINK system (3932 = Adalink)
- CLIMALINK system (3932 = Climatic)

Tables of MODBUS, LONWORKS, BACNET & TREND addresses are given in an appendix at the end of this manual.

The identification number of each unit can be set (3931) and the communication speed is adjustable between 1200 Bd and 19200 Bd (3933).

- 3931** → Address of the unit on the bus
- 3932** → Choice of type of protocol
- 3933** → Choice of communication speed

#### ***MODBUS protocol***

For this option the BM50 must be fitted with the PCO1004850 card  
This card is used to interface a BM50 with an RS485 type bus.  
The card provides optically coupled isolation between the regulator and the RS485serial network.

On the Climatic™, set point 3932 = ModBus

- Transmission Mode = RTU
- Baud Rate = set point 3933 (1200/2400/4800/9600/19200)
- Word Length = 8
- Parity = NONE
- Stop Bits = 2

Card Id = set point 3931 (1 to 199)

#### ***LONWORKS protocol***

For this option the BM50 must be fitted with the PCO10000F0 card  
This card is used to interface a BM50 with a LonWorks® network by FTT-10A 78 kbs (TP/FT-10).

On the Climatic™, set point 3932 = LonWorks  
Baud Rate = set point 3933 (4800)

Device Id = set point 3931 (1 to 199)

#### ***'Watchdog' function for theClimatic™50.***

The Climatic™50 automatic control system, being passive on the bus, cannot detect all communication failures with the BMS. Therefore in the event of a communication failure, the unit will continue to function with the last settings transmitted by the BMS.

To prevent this risk from hindering correct operation of the unit, the BMS must regularly write a non-zero value in word 01h. On its side, the Climatic™50 automatic control system decrements the value of word 01h by 5 units every 5 seconds.

The following points are therefore not taken into account by the Climatic™50 automatic control system program if word 01h is equal to 0 and in this case the latter works with the internally programmed set points.

This function does not prevent writing of the bit or word; these can always be read on the DS50 display (set to BMS mode by means of the 'Prg' button)

Word 01h being available in read/write on our display, we are able to test the BMS mode manually and see the value decrementing then returning to internal control mode.

Points affected by word 01h

Words:  02H/03H /04H/05H/06H/07H/08H

## Configuring the BM50 pLan address

### Function

It may be necessary to change the address of the BM50 card on the pLan network – mainly in the case of Master/Slave installation or a DM50. To do this, use the following procedure:

### Description

#### Set the address of the DS50 display to 0;

Sds.1



Access the configuration mode by pressing the button **↑ ↓ ←**, for at least 5 seconds until the Sds.1 screen appears:  
 Press button **←** to position the cursor over the 'Setting' line  
 With the **↑** or **↓** button, set the address of the display to 00 (instead of the standard value of 32) and confirm with button **←**

Sds.2



The Sds.2 screen appears.

#### Changing the address of BM50

Sds.3

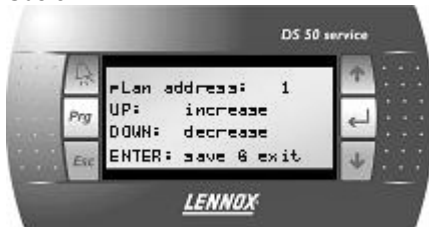

Switch the power supply to the BM50 card off, then on again after 5 seconds.  
 When the Sds.3 screen appears, press, the 'Alarm' and **↑** buttons for 5 seconds.

Sds.4

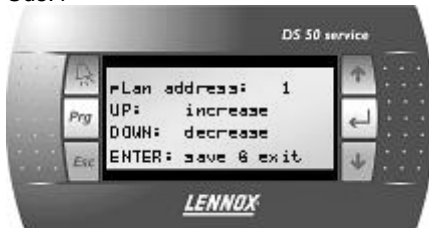

The Sds.4 screen appears.  
 Press the button **←** to position the cursor over the 'pLan address' line  
 With button **↑** or **↓** set the desired pLan address (1 to 12) and confirm with button **←**

Reset the original address of the DS50 (32) using the above procedure.



# Allocation of Displays to the BM50

## Function

Ensure there is a good connection between the BM50 and its displays

## Description

For each Climatic™50 card the following setting must be made using the DS50.

Disconnect the pLan bus at J10 and J11 and connect the DS50, directly to J10 of the BM50;

Sds.1



Access the configuration mode by pressing buttons  $\uparrow$   $\downarrow$   $\leftarrow$  , for at least 5 seconds until the Sds.1 screen appears:  
 Press the button  $\leftarrow$  to position the cursor over the 'Setting' line  
 Press button  $\leftarrow$  again to position the cursor over the 'I/O board address' line  
 With button  $\uparrow$  or  $\downarrow$  replace '-' with the address of the BM50 connected and confirmed with button  $\leftarrow$

Sds.5



The Sds.5 screen appears.  
 Press button  $\leftarrow$

Sds.6 (for the DC50)

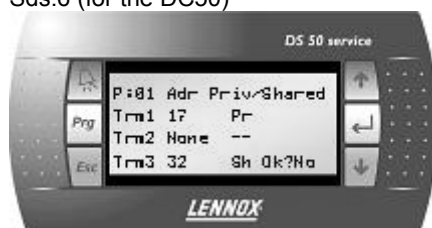

The Sds.6 screen appears.  
 The field "P:XX " shows the selected pLan address. In this example the value "01" has been selected.  
 The fields in the "Adr" column represent the addresses of the terminal displays associated with this BM50, while the "Priv/Shared" column indicates the status of the selected terminal.

Pr: Private  
 Sh: Shared  
 Sp: Shared Printer (N/A)

Sds.6 (for the DM50)

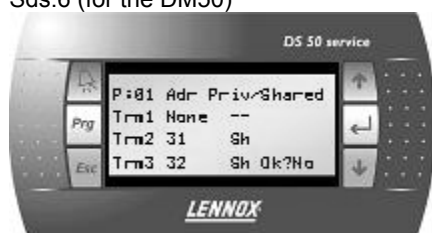

Move the cursor from field to field using button  $\leftarrow$   
 Select the value desired using button  $\uparrow$  or  $\downarrow$ .  
 To exit the configuration procedure and save the data, select the "OK?No", field, choose "Yes" using buttons  $\uparrow$  or  $\downarrow$  and confirm by pressing  $\leftarrow$

- Trm1** is reserved to allocate the **DC50** to the BM50.  
 Its value differs depending on the pLan address of the BM50 (see table opposite)  
 Its status is always 'Pr'  
 In the case of connection to a DM50, set the address to 'None'
- Trm2** is reserved to allocate the **DM50** to the BM50.  
 Its value is always 31  
 Its status is always 'Sh'  
 In the case of connection to a DC50, set the address to 'None'
- Trm3** is reserved to allocate the **DS50** to the BM50.  
 Its value is always 32  
 Its status is always 'Sh'

pLan address of the BM50	Trm1 DC50
1	17 pr
2	18 pr
3	19 pr
4	20 pr
5	21 pr
6	22 pr
7	23 pr
8	24 pr
9	25 pr
10	26 pr
11	27 pr
12	28 pr

If the terminal remains inactive (no button is pressed) for 30 seconds, the configuration procedure is aborted automatically.

# DC50 COMFORT & DM50 MULTI CUSTOMER DISPLAY



## Function

This display is connected remotely; it is intended for users with no technical knowledge. This display gives access to general operating data of the unit, it does not give access to detailed operating data. It can be used to set or change the programming of the various time periods and the temperature set point for each period. It also has the ability to set a 3 hour override and force an unoccupied mode, or any other different time period, for a maximum of 7 days. It displays a real time clock and the various fault signals.

## Description

### Buttons



'Prg' Access set points



'Clock' Access the clock



'Esc' Return to the previous display



'Up' Access overrides or increase values



'Enter', Confirms the selection



'Down' Access overrides or decrease values

### Brightness/Contrast

The display has a set contrast, but this can be adjusted manually. For manual adjustment of the contrast, press the 'Prg' and 'Clock' buttons simultaneously and press buttons  $\uparrow$  or  $\downarrow$  to increase or reduce the contrast.

### Configuring the terminal address

Sdc.1



The address of the terminal (DC50 or DM50) must be checked after having switching on the card.

Access the configuration mode by pressing buttons  $\uparrow$   $\downarrow$   $\leftarrow$  simultaneously for at least 5 seconds, until the Sdc.1 screen appears.

Press the 'Enter' button to position the cursor over the 'Setting' line. With button  $\uparrow$  or  $\downarrow$ , set the address of the display. See table below for the DC50, the DM50 is always 31, then confirm with button  $\leftarrow$

pLan address with BM50 connected	DC50 Address
1	17
2	18
3	19
4	20
5	21
6	22
7	23
8	24
9	25
10	26
11	27
12	28

Sdc.2



The Sdc.2 screen appears.

If after 5 seconds the display is not correct;  
Return to the configuration mode by pressing buttons  
↑ ↓ ← simultaneously for at least 5 seconds until the Sdc.1 screen  
appears.

Press button ← to position the cursor over the 'Setting' line

Press, the button ← again to position the cursor over the 'I/O board  
address' line

With the button ↑ or ↓, replace '-' with the address of the BM50  
connected and confirm with button ←

Then repeat the procedure " Allocation of Displays to the BM50 "

### Functions with DM50

The screens and functions of the DM50 are the same as the screens of the DC50.

A DC must be connected to one, and only one, BM50. Even if the unit is connected to the pLan bus, the screens of the DC50 will only apply to the configured BM50.

One DM50 may be connected to 12 units with the pLan bus. The screens of the DM50 will apply to one of the BM50 alternately.

Sdm.1



On the bottom line of the BM50 the symbol '□' indicates the BM50s  
identified on the pLan bus (number 1 on the left, up to number 12  
on the right)

A unit that is disconnected or switched off cannot be displayed  
by the DM50.

The number in brackets at the bottom left indicates the number of  
the BM50 currently connected to the DM50.

In the event of a fault on one or other of the BM50s identified, the  
'Prg' button is illuminated in red and the symbol '□' for the units  
concerned flashes.

To display another unit from the main display, press button ↓.

### Main screen

Sdc.3



On the first line, as a double display:

Ambient temperature

Fan on or off.

On the second line:

Degree of opening of the air regulator (option)

'Dyn' if the offset function of the set point as a function of the outside  
temperature deviation is active.

'Vent :Auto' if the fan start/stop in the dead zone of the adjustment  
function is configured.

On the third line:

Outside air temperature

Current time period (Z :A, Z :B, Z :C, Uno, Ove and BMS)

Mode of operation (Hot, Dead or Cold)

### 3 hour override

These functions can be used to override either the desired ambient temperature or the minimum air change rate for 3 hours.

Sdc.3



If an override is active, the time period display is altered with the  
'Der' symbol

The 'Esc' button is used to cancel the override mode.

From the main screen, press button ↑ or ↓

(Press button ↑ On the DM50)

Sdc.4



Screen Sdc.4 is used to change the override values  
 The present time period is shown on the 2nd line. This period will remain fixed for 3 hours.  
 Press **←** to position the cursor over the 'Csg. Amb.' line  
 With button **↑** or **↓**, set the desired temperature and confirm with the 'Enter' button.  
 The cursor is positioned over the 'Min. A.N.' line  
 With button **↑** or **↓**, set the desired air change rate and confirm with button **←**  
 The DC50 returns to the main display.

If the unit is not fitted with the economiser option, only the temperature line is displayed.

A single press on the 'Esc' button cancels the changes and returns to the main screen.

It will revert back to the main screen after 15 seconds without any activity.

### **Clock Menu**

These screens are used to display and change the time and date on the BM50.

Sdc.5



From the main screen, press the 'clock' button  
 The Sdc.5 screen displays the time and date.

To change the time or date:  
 Press **←** to position the cursor over the time.  
 With button **↑** or **↓** set the time and confirm with button **←**  
 Position the cursor over 'minutes'.  
 With button **↑** or **↓** set the minutes and confirm with button **←**  
 Position the cursor over 'month'.  
 With button **↑** or **↓** set the month and confirm with button **←**  
 Position the cursor over 'year'.  
 With button **↑** or **↓** set the year and confirm with button **←**  
 Position the cursor over 'hours'.  
 ...

Pressing the 'Esc' returns to the main screen

It will revert back to the main screen after 15 seconds without any activity.

### **"Programming" Menu**

These screens are used to display and change the set points of the BM50 for each time period.

Sdc.6



From the main screen, press the "Prg" butto,  
 Screen Sdc.6 displays the temperature set point and the minimum airflow rate.

If the unit is not fitted with the economiser option, only the temperature line is displayed.

With button **↑** or **↓** set the desired temperature and confirm with button **←**  
 The cursor is positioned over the 'Min. A.N.' line  
 With button **↑** or **↓** set the desired air change rate and confirm with button **←**  
 Position the cursor over the 'Csg. Amb.' line

Pressing the 'Esc' returns to the main screen.

The time period can be selected by repeatedly pressing the 'Clock' button,

Sdc.7



From the Sdc.6 screen; press the 'Prg' button  
Screen Sdc.7 displays the period settings.

Position the cursor over period A  
With button  $\uparrow$  or  $\downarrow$  set the start time for period A and confirm with button  $\leftarrow$   
Position the cursor over period B.  
With button  $\uparrow$  or  $\downarrow$  set the start time for period B and confirm with button  $\leftarrow$   
Position the cursor over period C.  
With button  $\uparrow$  or  $\downarrow$  set the start time for period C and confirm with button  $\leftarrow$   
Position the cursor over the Ino period.  
With button  $\uparrow$  or  $\downarrow$  set the unoccupied period and confirm with button  $\leftarrow$   
Position the cursor over period A.

...

Pressing the 'Esc' returns to the main screen.

Select the day of the week by repeatedly pressing the 'Clock' button  
It will revert back to the main screen after 15 seconds without any activity.

Alarms

**Filter Alarm**

Sdc.8



In the event of activation of a filter fault on the unit, screen Sdc.8 is displayed.  
The 'Clock' button is illuminated.  
All buttons are deactivated

The only way to regain control of the DC50 is to clean or replace the filters in the unit.

**Major Alarm**

Sdc.9



In the event of activation of a fault on the unit, screen Sdc.9 is displayed.  
Button 'Prg' is illuminated.  
All buttons are deactivated

\*

The only way to regain control of the DC50 is to resolve the fault on the unit.

To display the alarm history of the unit, press button  $\leftarrow$

The history can store the last 32 alarms occurring on the unit.  
Each alarm is memorised at the date and time of occurrence of the fault.  
An active alarm is signified by the symbol '\*'.  
An acknowledged alarm is signified by the symbol '='.  
Each alarm is signified by a 3 digit code (see ERROR CODES)

Sdc.10



Sdc.11



Press the 'Alarm' button to reset all the alarms, if possible  
The number of active alarms returns to 0, no active alarm is shown in the menu, and the 'Alarm' button is no longer illuminated.

To highlight the title of the error code, position the cursor over the line desired with buttons  $\uparrow$  or  $\downarrow$ , then confirm with the 'Enter' button

Use the 'Esc' button to return to the previous levels.

### Start/stop

Sdc.3



From the main screen, press the **←** button  
The Sdc.12 screen appears.

Sdc.12



To stop the unit:  
With button **↑** or **↓** set the value to 'Yes' and confirm with button **←**  
The unit stops and the Sdc.13 screen appears

**WARNING:** Switching off the unit disables all the safety devices

Pressing the 'Esc' returns to the main screen.

Sdc.13



If the unit is stopped, the Sdc.13 screen appears.  
To start the unit, press button **←**  
The unit starts and the main screen appears.

### 1 week override

This function overrides the operating periods for a maximum of 7 days.

Sdc.14



From the Sdc.12 screen, press button **←** twice to position the cursor over the 'Override a period' line  
With button **↑** or **↓** set the period desired and confirm with button **←**

The Sdc.14 screen appears.  
With button **↑** or **↓** set the days of the week to the period desired and confirm with button **←**

In this example, the unit will remain in the unoccupied period on Tuesday when confirmed until midnight on Thursday.







# DS50 SERVICE DISPLAY

## Function

This plug and play type display is intended for maintenance technicians.

## Description

### Buttons

	'Alarm' summarises the Alarm menu		'Up' scrolls the menu upwards or increases the value
	'Prg' Changes the time period		'Enter' confirms the selection
	'Esc' Returns to the previous screen		'Down' scrolls the menu downwards or reduces the value

## Brightness/Contrast

The display has a set contrast, but it can be adjusted manually. To set the contrast manually, press the 'Alarm' and 'Prg' buttons simultaneously and press buttons  $\uparrow$  and  $\downarrow$  to increase or decrease the contrast

## Startup screens

S.1



The DS50 display is provided to communicate with all the BM50s connected to the pLAN bus alternately. On activation of the display, screen S.1, the line 'Unit:' line requests entry of the pLAN number of the desired BM50. With button  $\uparrow$  or  $\downarrow$  replace '-' with the address of the BM50 and confirm with button  $\leftarrow$

S.2



The S.2 screen appears. Press the 'Prg' button or any other button to continue

If a DC50 or a DM50 is connected to the BM50, the display and buttons on the remote display are inhibited and the word 'Lennox' is displayed. This disappears as soon as the DS50 is disconnected from the BM50.

S.3



This S.3 screen indicates the versions of the software loaded in the BM50. In this example, it shows us;  
 A version 50.22 'RT' Roof-Top and AirCooler program  
 A version 4.10 Bios  
 A version 4.03 Boot

In the case of a specific program for one job (NSR), this is identified by the display of a factory number to the left of the S.4.program version.

S.4



**Language selection**  
 Twelve languages are currently available (DE, DK, FR, GB, IT, NL, PL, PT, RO, SE, SP, TR) but only 2 are installed in the factory (English + xxx). The language required must therefore be specified at the time of ordering. If required, another language can be downloaded on site by a Lennox technician.  
 With button  $\uparrow$  or  $\downarrow$  select 'English' or the second language initially loaded and confirm with button  $\leftarrow$   
 To continue without changing the language, press the 'Prg', 'Esc' or  $\leftarrow$  buttons

## Navigation in the screens

### Main menu (0000)

S.5

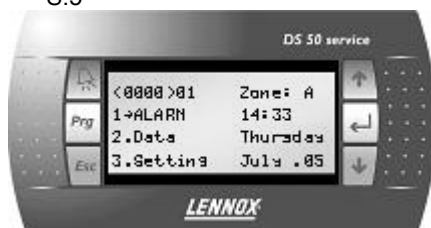

The four digits in brackets indicate the number of the current menu. The two digits beside the brackets indicate the pLan number of the selected card.

The display on the right indicates the period of operation and the current time conditions.

S.6

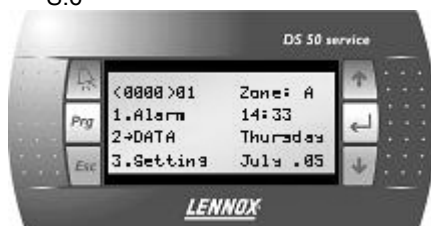

Scrolling the menus

Press button  $\uparrow$  or  $\downarrow$  to move the cursor upwards or downwards. The item selected is displayed in CAPITAL letters preceded by the symbol '→'. It can then be selected by pressing button  $\leftarrow$

A '+' or '++' symbol beside the number of the first or third line indicates the existence of one or more additional lines.

### Data (2000)

S.7

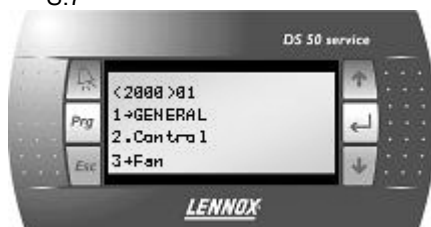

Examples S.6 to S.9 show how the menu tree changes each time button  $\leftarrow$  from the menu is pressed

$\leftarrow$  Data (2000)

$\leftarrow$  General (2100)

$\leftarrow$  Temperature (2210)

(2211) Outside temperature 27.9°C

(2212) Room temperature 24.5°C

(2213) Blower temperature 12.3°C

S.8



S.9

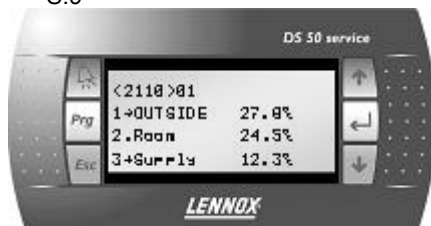

Press "Esc" at any time sends to return to the previous level of the menu tree. In the example shown above, "Esc" must be pressed 3 times to return to the main menu (0000)



## Alarms (1000)

S.10



In the event of an alarm on the unit, the 'Alarm' button is illuminated in red. In the event of a filtration fault, the 'Prg' button is illuminated in yellow.

To display the alarm history of the unit, position the cursor over the '1 Alarm' line with buttons  $\uparrow$  or  $\downarrow$ , then confirm with button  $\leftarrow$  or press the 'Alarm' button directly, wherever you are in the menu tree.

S.11

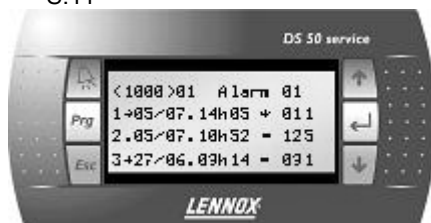

The history can store the last 32 alarms occurring on the unit. Each alarm is memorised at the date and time of occurrence of the fault. An active alarm is signified by the symbol '\*'. An acknowledged alarm is signified by the symbol '='. Each alarm is signified by a 3 digit code (see ERROR CODES)

Press the 'Alarm' button to reset all the alarms, if possible. The number of active alarms returns to 0, no active alarm is shown in the menu, and the 'Alarm' button is no longer illuminated

S.12



Pressing the 'Alarm' key for more than 10 seconds resets the history of the 32 alarms to zero.

To highlight the title of the error code; position the cursor over the line desired, with buttons  $\uparrow$  or  $\downarrow$ , then confirm with button  $\leftarrow$ . Use the 'Esc' button to return to the previous levels of the menu tree.

## Set points (3000)

S.13



To changed a parameter on a set point; Select the 'SET POINTS line from the main menu, then navigate to the sub-menus until the desired set point is displayed (e.g. 3120).

Position the cursor over the line desired (e.g. 2.) then confirm with button  $\leftarrow$

S.14



Screen S.14 is used to change a set point (e.g. Minutes p.3122). The maximum and minimum thresholds for the parameter are displayed on the right of the screen, as well as the predefined default value.

With button  $\uparrow$  or  $\downarrow$  set the desired value and confirm with button  $\leftarrow$

Use the 'Esc' button to return to the previous levels of the menu tree. Pressing the 'Esc' button once without confirmation with the 'Enter' button cancels the change.

S.15



If the day of the week is displayed on the first line, the parameter in question can be set to a different value for each day of the week

To display and change the values of other days, press the 'Prg' button.

Pressing the 'Prg' button confirms the change in the same way as button  $\leftarrow$

S.16

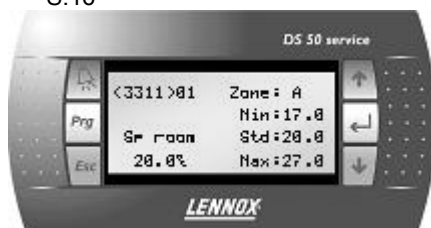

If the period of operation is displayed on the first line, the parameter in question can be set to a different value for each for each period (Z.A, Z.B, Z.C, Ino and GTC).

To display and change the values of other periods, press the 'Prg' button.

Pressing the 'Prg' button confirms the change in the same way as button  $\leftarrow$

### Special diagnostic screens

In order to analyse the operation of the unit, it is possible to use the following screens which can be reached by pressing the 'Prg' button in menu 0000 or the data menus 2xxx

Press button  $\uparrow$  or  $\downarrow$  to navigate from one screen to another

Screens are available as functions of the program configuration.

T.1

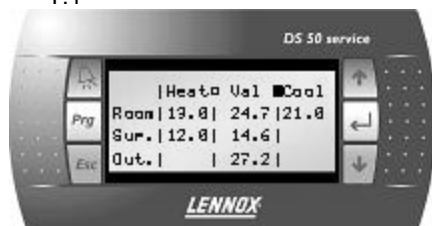

T.1 General temperatures

Heating or Cooling mode of operation  
Environment; Hot Set Point, Temperature, Cold Set Point  
Blowing; Hot Set Point, Temperature  
Outside Air; Temperature

T.2

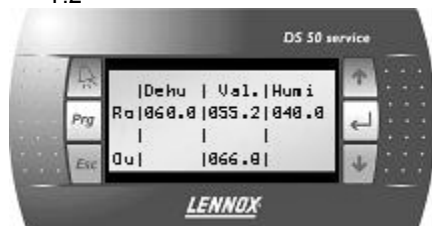

T.2 General humidity  
(Option)

Environment; Dehumidification Set Point, Humidity, Humidification Set Point  
Outside Air; Humidity

T.3



T.3 General Power Factors, Temperature

Environment; Hot Factor, Cold Factor  
Blowing; Hot Factor

T.4



T.4 General Power Factors, Humidity  
(Option)

Environment; Dehumidification Factor, Humidification Factor

T.5

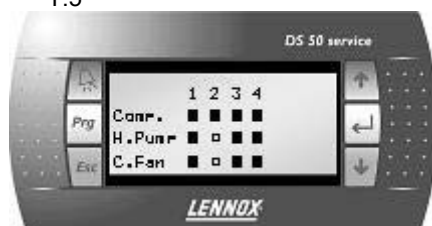

T.5 Condenser Compressors and Fans

Circuit 1, Circuit 2, Circuit 3 or Circuit 4  
' $\leftrightarrow$ ' Stop or '■' Start; Compressors  
' $\leftrightarrow$ ' Stop or '■' Start; Cycle reversing valve  
' $\leftrightarrow$ ' Stop or '■' Start; Condenser fans

T.6

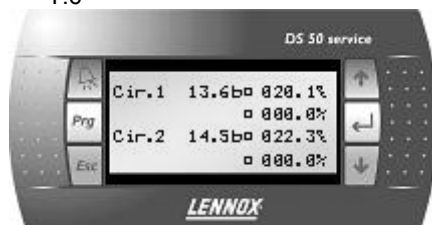

T.6 Condenser Compressors and Fans  
(Option)

Circuit 1, Circuit pressure, ' $\leftrightarrow$ ' H.P. or '□' L.P.; Circuit temperature.  
Circuit 1, '□' End of defrosting, Speed variation power factor.  
Circuit 2, Circuit pressure, ' $\leftrightarrow$ ' H.P. or '□' L.P.; Circuit temperature.  
Circuit 2, '□' End of defrosting, Speed variation power factor.

T.7

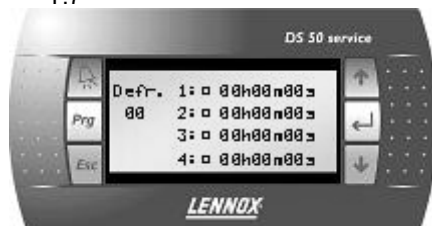

T.7 Defrost  
(Option)

Circuit 1, '□' Deicing requested; Compressor operating time since last defrost  
Same for Circuits 2 to 4

T.8

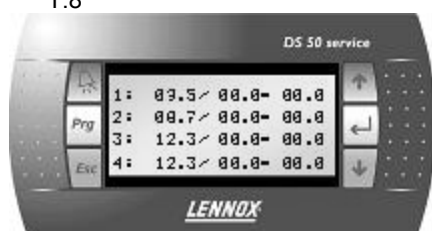

T.8 Dynamic defrosting  
(Option)

Circuit 1,  $\Delta t$  instantaneous;  $\Delta t$  memorised;  $\Delta t$  i/ $\Delta t$  m ratio  
Same for Circuits 2 to 4

$\Delta t$  = difference between Circuit temperature and outside air temperature.

T.9

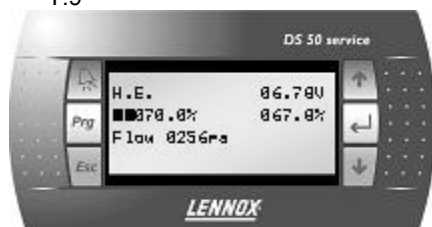

T.9 Speed variation, Treatment fan  
(Option)

Voltage (0-10v) applied to the speed controller  
'□' Fan on, '□' Speed controller on; Power factor; Requests  
Value of  $\Delta p$  inside the unit

T.10

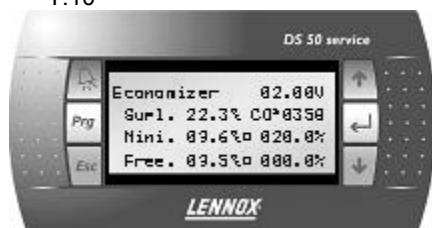

T.10 Fresh air regulator

Voltage (0-10v) applied to the servomotor  
Blowing Temperature; CO<sub>2</sub> level in ppm  
Calculated mixing threshold; Minimum opening requested.  
Calculated blowing threshold; Free-Cooling requested

T.11



T.11 Hot water heater  
(Option)

Voltage (0-10v) applied to the valve  
Frost thermostat '↔' faulty, '□' correct  
Opening requested

T.12



T.12 Gas Burners  
(Option)

Voltage (0-10v) applied to the proportional valve  
'↔' Stop or '□' Start; Burner 1  
'↔' Low demand or '□' High demand; Burner 1  
'↔' Stop or '□' Start; Burner 2  
Modulation requested

T.13



T.13 Electric heater elements  
(Option)

Voltage (0-10v) applied to the Triacs  
'↔' Stop or '□' Start; Heater unit 1  
'↔' Stop or '□' Start; Heater unit 2  
Modulation requested

T.14



T.14 BM50 present on the pLan bus

Displays the number of BM50s present on the pLan bus

T.15



T.15 Master/Slave functions

- '□' Hot/Cold Limitation; '□' Hot master; '□' Cold master
- '□' Limitation of compressors; number of compressors running
- '□' Back-up mode; Number of stand-by unit

T.16



T.16 Operating time

Press button '□' to position the cursor over the counter number.  
 With button ↑ or ↓ enter the desired counter number  
 Press button '□.' to change the field  
 To reset all the operating times to zero, select 'Yes' in the 'Clear' field  
 Indicates the date and time of the start of memorisation.

- MD0 BM50 switched on
- MD1 In Dead Zone
- MD2 In Cold Zone
- MD3 In Hot Zone
- MD4 Z.A
- MD5 Z.B
- MD6 Z.C
- MD7 Uno
- MD8 BMS
- MD9 Ventilation
- MD10 Damper set to Min Fresh Air Without Compressor
- MD11 Damper set to Min Fresh Air With Compressor
- MD12 Damper in Free Cooling Without Compressor
- MD13 Damper in Free Cooling With Compressor
- MD14 Circuit 1 & Compressor 1 Cold with Min Fresh Air
- MD15 Circuit 1 & Compressor 1 Cold with Free Cooling
- MD16 Circuit 1 & Compressor 1 Hot
- MD17 Circuit 1 & Compressor 1 Defrosting
- MD18 Circuit 1 & Compressor 2 Cold with Min Fresh Air
- MD19 Circuit 1 & Compressor 2 Cold with Free Cooling
- MD20 Circuit 1 & Compressor 2 Hot
- MD21 Circuit 1 & Compressor 2 Defrosting
- MD22 Circuit 2 & Compressor 1 Cold with Min Fresh Air
- MD23 Circuit 2 & Compressor 1 Cold with Free Cooling
- MD24 Circuit 2 & Compressor 1 Hot
- MD25 Circuit 2 & Compressor 1 Defrosting
- MD26 Circuit 2 & Compressor 2 Cold with Min Fresh Air
- MD27 Circuit 2 & Compressor 2 Cold with Free Cooling
- MD28 Circuit 2 & Compressor 2 Hot
- MD29 Circuit 2 & Compressor 2 Defrosting
- MD30 Circuit 3 & Compressor 1 Cold with Min Fresh Air
- MD31 Circuit 3 & Compressor 1 Cold with Free Cooling
- MD32 Circuit 3 & Compressor 1 Hot
- MD33 Circuit 3 & Compressor 1 Defrosting
- MD34 Circuit 4 & Compressor 1 Cold with Min Fresh Air
- MD35 Circuit 4 & Compressor 1 Cold with Free Cooling
- MD36 Circuit 4 & Compressor 1 Hot
- MD37 Circuit 4 & Compressor 1 Defrosting
- MD38 Supplementary heating 25%
- MD39 Supplementary heating 50%
- MD40 Supplementary heating 75%
- MD41 Supplementary heating 100%

T.17

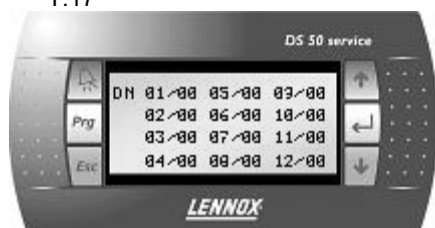

T.17 DM50 Loop (Option)

Displays the rotation of the cards on request from the DM50

# DS50 MENU TREE

Menu	Item	Menu	Item	Menu	Item	Menu	Item	Unité	Mini.	Usine	Maxi.
1000	Alarm	.									
2000	Data	2100	General	2110	Temperature	2111	Outside	°c			
						2112	Room	°c			
						2113	Supply	°c			
						2114	Return	°c			
				2120	Humidity	2121	Outside	%.			
						2122	Room	%.			
						2123	Outside	g/Kg			
						2124	Room	g/Kg			
				2130	Other	2131	Air Pres	pa			
						2132	Co2	ppm			
						2133	Sw On/Off	Off/On			
						2134	Sw Reset	Off/On			
						2135	Sw Unoc.	Off/On			
				2140	Out. Custom.	2141	bm50.1	Off/On			
						2142	be50.1	Off/On			
						2143	be50.2	Off/On			
						2144	be50.3	Off/On			
						2145	be50.4	Off/On			
				2150	In. Custom.	2151	bm50.1	Off/On			
						2152	bm50.2	Off/On			
						2153	be50.1	Off/On			
						2154	be50.2	Off/On			
						2155	be50.3	Off/On			
						2156	be50.4	Off/On			
				2160	In.% Custom.	2161	be50.1	°c			
						2162	be50.2	°c			
						2163	be50.3	°c			
						2164	be50.4	°c			
						2165	be50.1	%.			
						2166	be50.2	%.			
						2167	be50.3	%.			
						2168	be50.4	%.			
		2200	Control	2210	Room	2211	Sp Cool	°c			
						2212	Sp Heat	°c			
						2213	Capa Cool	%			
						2214	Capa heat	%			
						2215	Sw Dis.Cool	Off/On			
						2216	Sw Dis.Heat	Off/On			
						2217	4-20mA	°c			
				2220	Reheat	2221	Set Point	°c			
						2222	Capacity	%			
				2230	Humidity	2231	Sp Dehu	%			

Menu	Item	Menu	Item	Menu	Item	Menu	Item	Unité	Mini.	Usine	Maxi.
						2232	Sp Humi	%			
						2233	Capa Dehu	%			
						2234	Capa Humi	%			
		2240	Tcb			2241	Sw g	Off/On			
						2242	Sw y1	Off/On			
						2243	Sw y2	Off/On			
						2244	Sw w1	Off/On			
						2245	Sw w2	Off/On			
						2246	Sw b	Off/On			
2300	Fan	2310	Ventilation			2311	Config.	Lst_Conf			
						2312	State	Lst_Stat			
						2313	Sw State	Off/On			
						2314	Fire/Smoke	Off/On			
						2315	Relay	Off/On			
						2316	Low Speed	Off/On			
						2317	Sw Speed	Off/On			
						2318	Run Time	h			
		2320	Exhaust			2321	State	Lst_Stat			
						2322	Relay 1	Off/On			
						2323	Relay 2	Off/On			
						2324	Relay 3	Off/On			
		2330	Condenser 1			2331	Config.	Lst_Conf			
						2332	State	Lst_Stat			
						2333	Sw State	Off/On			
						2334	Relay	Off/On			
		2340	Condenser 2			2341	Config.	Lst_Conf			
						2342	State	Lst_Stat			
						2343	Sw State	Off/On			
						2344	Relay	Off/On			
		2350	Condenser 3			2351	Config.	Lst_Conf			
						2352	State	Lst_Stat			
						2353	Sw State	Off/On			
						2354	Relay	Off/On			
		2360	Condenser 4			2361	Config.	Lst_Conf			
						2362	State	Lst_Stat			
						2363	Sw State	Off/On			
						2364	Relay	Off/On			
2400	Cooler	2410	Fresh Air			2411	Config.	Lst_Conf			
						2412	State	Lst_Stat			
						2413	Mini.Air	%			
						2414	Modulat.	%			
						2415	Opening	%			
						2416	Calib.	No/Yes			
						2417	4-20mA	%			
		2420	Cold W/Coil			2421	Config.	Lst_Conf			
						2422	State	Lst_Stat			
						2423	Opening	%			

Menu	Item	Menu	Item	Menu	Item	Menu	Item	Unité	Mini.	Usine	Maxi.
		2500	Compressor	2510	Circ.1-Cp.1	2511	Config.	Lst_Conf			
						2512	State	Lst_Stat			
						2513	Defrost T	°c			
						2514	Sw State	Off/On			
						2515	Sw Low P.	Off/On			
						2516	Relay	Off/On			
						2517	H.Pump	Off/On			
						2518	Sw Disable	Off/On			
						2519	Run Time	h			
				2520	Circ.1-Cp.2	2521	Config.	Lst_Conf			
						2522	State	Lst_Stat			
						2523	Defrost T	°c			
						2524	Sw State	Off/On			
						2525	Sw Low P.	Off/On			
						2526	Relay	Off/On			
						2527	H.Pump	Off/On			
						2528	Sw Disable	Off/On			
						2529	Run Time	h			
				2530	Circ.2-Cp.1	2531	Config.	Lst_Conf			
						2532	State	Lst_Stat			
						2533	Defrost T	°c			
						2534	Sw State	Off/On			
						2535	Sw Low P.	Off/On			
						2536	Relay	Off/On			
						2537	H.Pump	Off/On			
						2538	Sw Disable	Off/On			
						2539	Run Time	h			
				2540	Circ.2-Cp.2	2541	Config.	Lst_Conf			
						2542	State	Lst_Stat			
						2543	Defrost T	°c			
						2544	Sw State	Off/On			
						2545	Sw Low P.	Off/On			
						2546	Relay	Off/On			
						2547	H.Pump	Off/On			
						2548	Sw Disable	Off/On			
						2549	Run Time	h			
				2550	Circ.3-Cp.1	2551	Config.	Lst_Conf			
						2552	State	Lst_Stat			
						2553	Defrost T	°c			
						2554	Sw State	Off/On			
						2555	Sw Low P.	Off/On			
						2556	Relay	Off/On			
						2557	H.Pump	Off/On			
						2558	Sw Disable	Off/On			
						2559	Run Time	h			
				2560	Circ.4-Cp.1	2561	Config.	Lst_Conf			
						2562	State	Lst_Stat			

Menu	Item	Menu	Item	Menu	Item	Menu	Item	Unité	Mini.	Usine	Maxi.
						2563	Defrost T	°c			
						2564	Sw State	Off/On			
						2565	Sw Low P.	Off/On			
						2566	Relay	Off/On			
						2567	H.Pump	Off/On			
						2568	Sw Disable	Off/On			
						2569	Run Time	h			
		2570	Other			2571	Low Amb.	Off/On			
						2572	W/Cond.1	°c			
						2573	W/Cond.2	°c			
2600	Heater	2610	Gas			2611	Config.	Lst_Conf			
						2612	State	Lst_Stat			
						2613	Sw State 1	Off/On			
						2614	Sw State 2	Off/On			
						2615	Relay 1	Off/On			
						2616	Relay 2	Off/On			
						2617	High	Off/On			
						2618	Modulat.	%			
						2619	Sw Disable	Off/On			
		2620	Elec. H.			2620	Config.	Lst_Conf			
						2621	State	Lst_Stat			
						2622	Sw State 1	Off/On			
						2623	Sw State 2	Off/On			
						2624	Relay 1	Off/On			
						2625	Relay 2	Off/On			
						2626	Modulat.	%			
						2627	Sw Disable	Off/On			
		2630	Hot W/Coil			2630	Config.	Lst_Conf			
						2631	State	Lst_Stat			
						2632	Opening	%			
						2633	Sw Freeze	Off/On			
						2634	Sw Disable	Off/On			
		2640	Pump			2640	Config.	Lst_Conf			
						2641	State	Lst_Stat			
						2642	Sw State	Off/On			
						2643	Relay	Off/On			
2700	Humidif.					2711	Config.	Lst_Conf			
						2712	State	Lst_Stat			
						2713	Sw State	Off/On			
						2714	Modulat.	%			
2800	Com.	2810	Outside			2811	Value	°c			
						2812	Sensor	°c			
						2813	Link	°c			
						2814	Bms	°c			
						2815	Value	%.			
						2816	Sensor	%.			
						2817	Link	%.			



Menu	Item	Menu	Item	Menu	Item	Menu	Item	Unité	Mini.	Usine	Maxi.
						2818	Bms	%.			
				2820	Room	2820	Value	°c			
						2821	Sensor	°c			
						2822	Link	°c			
						2823	Bms	°c			
						2824	Value	%.			
						2825	Sensor	%.			
						2826	Link	%.			
						2827	Bms	%.			
3000	Setting	3100	General	3110	Order	3111	On/Off	Off/On	~	No	~
						3112	Reset Al.	No/Yes	~	No	~
						3113	Resume	No/Yes	~	No	~
						3114	Test	Lst_Test	0	0	6
				3120	Clock	3121	Hour	h	0	~	23
						3122	Minute	m	0	~	59
						3123	Day	~	1	~	31
						3124	Month	~	1	~	12
						3125	Year	~	2	~	99
						3126	Win/Sum	No/Yes	~	Yes	~
		3200	Schedule	3210	Time	3211	Start Uno	h	0	22	24
						3212	Start z.A	h	0	6	24
						3213	Start z.B	h	0	22	24
						3214	Start z.C	h	0	22	24
				3220	Anticipation	3221	Foot	°c	-10	10	20
						3222	Gradient	m/°c	0	0	100
		3300	Control	3310	Customer	3311	Sp Room	°c	8	20	35
						3312	Mini.Air	%	0	20	100
				3320	Room	3321	Sp Dyna	°c	0	99,9	99,9
						3322	Sp Cool	°c	8	21	35
						3323	Sp Heat	°c	8	19	35
						3324	Swap Heater	No/Yes	~	No	~
				3330	Reheat	3331	Activation	No/Yes	~	No	~
						3332	Swap Heater	No/Yes	~	No	~
				3340	Humidity	3341	Sp Dehu	%	0	100	100
						3342	Sp Humi	%	0	0	100
				3350	Enable.	3351	Fan On/Off	No/Yes	~	Yes	~
						3352	Fan Dead	No/Yes	~	Yes	~
						3353	F.Air	No/Yes	~	Yes	~
						3354	Co2	No/Yes	~	Yes	~
						3355	Comp.Cool.	No/Yes	~	Yes	~
						3356	Comp.Heat.	No/Yes	~	Yes	~
						3357	AuxHeat	No/Yes	~	Yes	~
						3358	Humidif.	No/Yes	~	Yes	~
						3359	Low Noise	No/Yes	~	No	~
				3360	Reactiv.	3361	Cooling	~	1	4	50
						3362	Heating	~	1	4	50
						3363	Reheat	~	1	4	50

Menu	Item	Menu	Item	Menu	Item	Menu	Item	Unité	Mini.	Usine	Maxi.
						3364	Dehu.	~	1	4	50
						3365	Humi.	~	1	4	50
		3370	Safety			3371	Room Low	°c	5	5	20
						3372	Room High	°c	20	40	40
						3373	Sup.Lo.1	°c	9.0 ou 5.0	10.0 ou 8.0	19
						3374	Sup.Lo.2	°c	7.0 ou 3.0	8.0 ou 6.0	17
						3375	Sup.Lo.3	°c	5.0 ou 1.0	6.0 ou 2.0	15
						3376	Sup.Hi.1	°c	20	40	70
						3377	Sup.Hi.2	°c	20	60	70
						3378	Room Low	%	0	0	1000
						3379	Room High	%	0	1000	1000
3400	Ventilation	3410	Filters			3411	Air Flow	pa	0	25	1000
						3412	No Filter	pa	0	50	1000
						3413	Dirty Fil	pa	0	250	1000
		3420	h.e.			3421	Sp Mini.	%	0	0	100
						3422	Sp Maxi.	%	0	100	100
						3423	Fan.Start	No/Yes	~	Yes	~
						3424	Dead Zone	No/Yes	~	No	~
		3430	Exhaust			3431	Fan,1	%	0	33	100
						3432	Fan, 2	%	0	50	100
						3433	Fan, 3	%	0	66	100
3500	Fresh Air					3511	Out.Limit	°c	-20	-20	40
						3512	Maximum	%	0	100	100
						3513	Mini.Co2	ppm	0	1000	2000
						3514	Maxi.Co2	ppm	0	1500	2000
						3515	Type	Lst_CO2M	0	0	1
						3516	Calib.	No/Yes	~	Yes	~
						3517	Recovery	No/Yes	~	No	~
3600	Compressor	3610	Out.Limit			3611	Cool. 50	°c	-10.0 ou 10.0	5.0 ou 12.0	40
						3612	Cool.100	°c	-10.0 ou 10.0	12.0 ou 20.0	40
						3613	Heat.100	°c	-50	-20	40
		3620	Defrost			3621	Type	Lst_Defr	0	0	1
						3622	Outside	°c	8	16	22
						3623	Coil	°c	-10.0 ou 1.0	2	10.0 ou 3.0
						3624	Time Limit	m	30	45	90
						3625	Time Fc	~	1	3	5
		3630	Safety			3631	W/Cd Mini	°c	4	5	20
						3632	W/Cd Maxi	°c	20	45	46
		3640	Mode			3641	Enable.	Lst_Cena	1	3 / 15	3 / 15
						3642	Rotat.	Lst_Rota	0	0	1
						3643	Dis. 50%Cp	No/Yes	~	No	~
3700	Heater	3710	Gas			3711	Type	Lst_Gas	0	1	1
		3720	Elec. H.			3721	Out.Limit	°c	-20	10	40
						3722	Sp Mixing	°c	0	5	10
						3723	Maximum	%	0	100	100
		3730	Hot W/Coil			3731	Out.Limit	°c	-20	10	40

Menu	Item	Menu	Item	Menu	Item	Menu	Item	Unité	Mini.	Usine	Maxi.	
							3732	Opening	%	0	0	50
							3733	A.Freeze	Lst_Afre	0	1	1
				3740	Pump		3741	Mode	Lst_Pump	0	0	3
3800	Config.	3810	Unit				3811	Range	Lst_Rang	0	6	13
							3812	Size	Lst_Size	0	0	162
							3813	Hu. Pack	No/Yes	~	No	~
							3814	h.e.	No/Yes	~	No	~
							3815	Tcb	No/Yes	~	No	~
		3820	Compressor				3821	Sensor	Lst_Sens	0	0	3
							3822	Lak	No/Yes	~	No	~
							3823	Wat/Cond	No/Yes	~	No	~
							3824	085/100 +	No/Yes	~	No	~
		3830	Option				3831	AuxHeat	Lst_AuxH	0	0	8
							3832	F.Air	Lst_Eco	0	0	3
							3833	P. Air	Lst_FAir	0	0	2
							3834	Co2	Lst_CO2C	0	0	2
		3840	Out. Custom.				3841	bm50.1	Lst_DO	0	0	15
							3842	be50.1	Lst_DO	0	0	15
							3843	be50.2	Lst_DO	0	0	15
							3844	be50.3	Lst_DO	0	0	15
							3845	be50.4	Lst_DO	0	0	15
		3850	In. Custom.				3851	bm50.1	Lst_DI	0	0	17
							3852	bm50.2	Lst_DI	0	0	17
							3853	be50.1	Lst_DI	0	0	17
							3854	be50.2	Lst_DI	0	0	17
							3855	be50.3	Lst_DI	0	0	17
							3856	be50.4	Lst_DI	0	0	17
		3860	In.% Custom.				3861	be50.1	Lst_AI	0	0	6
							3862	be50.2	Lst_AI	0	0	6
							3863	be50.3	Lst_AI	0	0	6
							3864	be50.4	Lst_AI	0	0	6
3900	Com.	3910	Display				3911	Sp Mini.	°c	8	17	21
							3912	Sp Maxi.	°c	21	27	35
							3913	Offset	°c	-5	0	5
							3914	Standard Sp	No/Yes	~	No	~
		3920	Master/Slave				3921	Id	~	1	1	12
							3922	Number	~	1	1	12
							3923	Type	Lst_MS_1	0	0	4
							3924	DC50 Mast.	No/Yes	~	No	~
							3925	Room	Lst_MS_2	0	0	2
							3926	Outside	Lst_MS_2	0	0	2
							3927	Co2	Lst_MS_2	0	0	2
		3930	Bms				3931	Id	~	1	1	199
							3932	Type	Lst_BMS	0	1	4
							3933	Baud	Lst_Baud	0	3	4
							3934	Watchdog	~	0	0	1000
							3935	Bms Unoc.	Off/On	~	Off	~

Menu	Item	Menu	Item	Menu	Item	Menu	Item	Unité	Mini.	Usine	Maxi.
						3936	Low Speed	Off/On	~	Off	~
				3940	Wireless	3941	Enable.	No/Yes	~	No	~
						3942	Dcw	~	0	0	1
						3943	Scw	~	0	0	6

# CLIMATIC™50 Input/Output Mapping

## 'Baltic' & 'Flexy 1' ranges

### BM50 – Main board

Digital Input		Digital Output		Analogue Input		Analogue Output	
J5.ID1	Gas Valve 1 Electric Heat Antifreeze sensor	J12.NO1	Gas Valve 1 Electric Heat 1 Pump	J2.B1	Filters/Fan (0~5V)	J4.Y1	Economizer (0~10V)
J5.ID2	Compressor 1	J12.NO2	Gas Valve 2 Electric Heat 2	J2.B2	Indoor, CO <sup>2</sup> (4~20mA)	J4.Y2	H/W Coil Valve (0-10V) Electric Heat. 'Triac' (0-10V) Modulating Gas (0-10V)
J5.ID3	Comp. 1, Low Pres.	J12.NO3		J2.B3	Comp. 1, Defrost (NTC) Outlet Cond. 'OR' 1 (NTC)	J4.Y3	C/W Coil Valve (0~10V) Modul. Coil Fan 1 (PWM)
J5.ID4	Blower	J13.NO4	Exhaust Fan	J2.B4	Comp. 2, Defrost (NTC) Outlet Cond. 'OR' 2 (NTC)	J4.Y4	Modul. Coil Fan 2 (PWM)
J5.ID5	Fire/Smoke Detector	J13.NO5	Compressor 1	J3.B5	Supply (NTC)		
J5.ID6	Coil Fan 1 Flow switch 'OR'	J13.NO6	Reversing Valve 1	J3.B6	Return (NTC)		
J5.ID7	ON/OFF	J14.NO7	Blower	J6.B7	Indoor (NTC)		
J5.ID8	Reset	J15.NO8 J15.NC8	Coil Fan 1	J6.B8	Outside (NTC)		
J7.ID9	Coil Fan 2	J16.NO9	Coil Fan 2				
J7.ID10	Compressor 2	J16.NO10	Compressor 2				
J7.ID11	Comp. 2, Low Pres.	J16.NO11	Reversing Valve 2				
J7.ID12	Gas Valve 2 Pump	J17.NO12 J17.NC12	By-p Recovery By-p Recovery Custom BM50-1				
J8.ID13	Pres. Switch Recovery Custom BM50-1	J18.NO13 J18.NC13	General Alarm				
J8.ID14	Custom BM50-2						

### BE50 – Extension board

Digital Input		Digital Output		Analogue Input		Analogue Output	
J4.ID1	Compressor 3 Custom BE50-1	J5.NO1 J5.NC1	Low speed Blower Custom BE50-1	J9.B1	Humidity, Indoor (4~20mA) TCB1 (4~20 mA) Custom BE50-1	J2.Y1	Humidifier (0~10V)
J4.ID2	Comp. 3, Low Pres. Custom BE50-2	J6.NO2 J6.NC2	Compressor 3 Custom BE50-2	J9.B2	Humidity, Outside (4~20mA) TCB2 (4~20 mA) Custom BE50-2		
J4.ID3	Compressor 4 Custom BE50-3	J7.NO3 J7.NC3	Compressor 4 Custom BE50-3	J10.B3	Comp. 3, Defrost (NTC) Custom BE50-3		
J4.ID4	Comp. 4, Low Pres. Custom BE50-4	J8.NO4 J8.NC4	Low Ambient Custom BE50-4	J10.B4	Comp. 4, Defrost (NTC) Custom BE50-4		

## 'Flexy II' roof-top range

### BM50 – Main board

Digital Input		Digital Output		Analogue Input		Analogue Output	
J5.ID1	Gas, Valve 1 Electric Heater H/W Coil, Antifreeze sensor	J12.NO1	Gas, Valve 1 Electric Heater, 1 Pump	J2.B1	Filters/Fan (0~5V)	J4.Y1	Economizer (0~10V) C/W Coil, Valve (0~10V)
J5.ID2	Circuit 1, Compressors	J12.NO2	Gas, Valve 2 Electric Heater, 2	J2.B2	Indoor, CO <sup>2</sup> (4~20mA)	J4.Y2	H/W Coil, Valve (0- 10V) Electric Heater, 'Triac' (0-10V) Gas (0-10V)
J5.ID3	Circuit 1, Low Pressure	J12.NO3	Exhaust Fan	J2.B3	Circuit 1, Defrost (NTC) Circuit 1, Pressure - 1~29b (4-20mA) Water Condenser, Circuit 1, Outlet (NTC)	J4.Y3	Circuit 1, Coil Fan (PWM)
J5.ID4	Blower	J13.NO4	Circuit 1, Compressor 1	J2.B4	Circuit 2, Defrost (NTC) Circuit 2, Pressure - 1~29b (4-20mA) Water Condenser, Circuit 2, Outlet (NTC)	J4.Y4	Circuit 2, Coil Fan (PWM)
J5.ID5	Fire/Smoke Detector	J13.NO5	Circuit 1, Compressor 2	J3.B5	Supply (NTC)		
J5.ID6	Circuit 1, Coil Fan Water Condenser, Flow switch	J13.NO6	Circuit 1, Reversing Valve	J3.B6	Return or Mixing (NTC)		
J5.ID7	ON/OFF	J14.NO7	Blower	J6.B7	Indoor (NTC)		
J5.ID8	Reset	J15.NO8 J15.NC8	Circuit 1, Coil Fan	J6.B8	Outside (NTC)		
J7.ID9	Circuit 2, Coil Fan	J16.NO9	Circuit 2, Compressor 1				
J7.ID10	Circuit 2, Compressors	J16.NO10	Circuit 2, Compressor 2				
J7.ID11	Circuit 2, Low Pressure	J16.NO11	Circuit 2, Reversing Valve				
J7.ID12	Gas, Valve 2 Pump	J17.NO12 J17.NC12	Circuit 2, Coil Fan				
J8.ID13	Custom BM50-1	J18.NO13 J18.NC13	General Alarm				
J8.ID14	Custom BM50-2						

### BE50 – Extension board

Digital Input		Digital Output		Analogue Input		Analogue Output	
J4.ID1	Blower HE, Alarm Custom BE50-1	J5.NO1 J5.NC1	Low speed Blower Custom BE50-1	J9.B1	Humidity, Indoor (4~20mA) TCB1 (4~20 mA) Custom BE50-1	J2.Y1	Humidifier (0~10V) C/W Coil, Valve (0~10V) Blower HE, Modulation (0~10V)
J4.ID2	Custom BE50-2	J6.NO2 J6.NC2	Custom BE50-2	J9.B2	Humidity, Outside (4~20mA) TCB2 (4~20 mA) Custom BE50-2		
J4.ID3	Custom BE50-3	J7.NO3 J7.NC3	Custom BE50-3	J10.B3	Custom BE50-3		
J4.ID4	Custom BE50-4	J8.NO4 J8.NC4	Custom BE50-4	J10.B4	Custom BE50-4		

## AirCooler range

### BM50 – Main board

Digital Input		Digital Output		Analogue Input		Analogue Output	
J5.ID1	Circuit 1, Compressor 1	J12.NO1	Electric Heater, 1	J2.B1	Filters/Fan (0~5V)	J4.Y1	Economizer (0~10V)
J5.ID2	Circuit 1, Compressor 2	J12.NO2	Electric Heater, 2	J2.B2	Indoor, CO <sup>2</sup> (4~20mA)	J4.Y2	Electric Heater, 'Triac' (0-10V)
J5.ID3	Circuit 1, Low Pressure	J12.NO3	Blower	J2.B3	Circuit 1, Defrost (NTC) Circuit 1, Pressure - 1~29b (4-20mA)	J4.Y3	Circuit 1, Coil Fan (PWM)
J5.ID4	Circuit 1, Coil Fan	J13.NO4	Circuit 1, Compressor 1	J2.B4	Circuit 2, Defrost (NTC) Circuit 2, Pressure - 1~29b (4-20mA)	J4.Y4	Circuit 2, Coil Fan (PWM)
J5.ID5	Fire/Smoke Detector	J13.NO5	Circuit 1, Compressor 2	J3.B5	Supply (NTC)		
J5.ID6	Blower	J13.NO6	Circuit 1, Reversing Valve	J3.B6	Return or Mixing (NTC)		
J5.ID7	ON/OFF	J14.NO7	Circuit 1, Coil Fan	J6.B7	Indoor (NTC)		
J5.ID8	Reset	J15.NO8 J15.NC8	Circuit 1, Low speed Coil Fan	J6.B8	Outside (NTC)		
J7.ID9	Circuit 2, Compressor 1	J16.NO9	Circuit 2, Compressor 1				
J7.ID10	Electric Heater	J16.NO10	Circuit 2, Reversing Valve				
J7.ID11	Circuit 2, Low Pressure	J16.NO11	Circuit 2, Coil Fan				
J7.ID12	Circuit 2, Coil Fan	J17.NO12 J17.NC12	Circuit 2, Low speed Coil Fan				
J8.ID13	Custom BM50-1	J18.NO13 J18.NC13	General Alarm				
J8.ID14	Custom BM50-2						

### BE50 – Extension board

Digital Input		Digital Output		Analogue Input		Analogue Output	
J4.ID1	Custom BE50-1	J5.NO1 J5.NC1	Custom BE50-1 Exhaust Fan 1	J9.B1	Humidity, Indoor (4~20mA) TCB1 (4~20 mA) Custom BE50-1	J2.Y1	Humidifier (0~10V)
J4.ID2	Custom BE50-2	J6.NO2 J6.NC2	Custom BE50-2 Exhaust Fan 2	J9.B2	Humidity, Outside (4~20mA) TCB2 (4~20 mA) Custom BE50-2		
J4.ID3	Custom BE50-3	J7.NO3 J7.NC3	Custom BE50-3	J10.B3	Custom BE50-3		
J4.ID4	Custom BE50-4	J8.NO4 J8.NC4	Custom BE50-4	J10.B4	Custom BE50-4		

## BMS Adress Tables ModBus, LonWorks

### MODBUS

#### Logical

@ (hexa)	@ (deci)				DS50
01H	1	R/W	L	[On / Off] Unit	3111
02H	2	R/W	L	[Reset] Discharges the safety measures of the unit	3112
03H	3	R/W	L	[Enable] Stopping and running of the Fan Blower. [Off] the blower is stopped, [On] the blower is running.	3351 <b>(BMS)</b>
04H	4	R/W	L	[Enable] Stopping and running of the fan in the "Control Dead Zone". [Off] the blower is stopped, [On] the blower is running.	3352 <b>(BMS)</b>
05H	5	R/W	L	[BMS] Activation of the Inoccupation mode [Off] occupation mode - [On] inoccupation mode	3935
06H	6	R/W	L	[Room regulation] Choices of the priority of regulation in Heating - [Off] Heat Pump then Hot water coil or Electric or Gas [On] Hot water coil or Electric or Gas then Heat Pump	3324 <b>(BMS)</b>
07H	7	R/W	L	[F-Air Reheat] Activate reheating of the fresh air in the dead zone to maintain supply temperature.	3331 <b>(BMS)</b>
08H	8	R/W	L	[F-Air Reheat] Choices of the priority of regulation in Heating - [Off] Heat Pump then Hot water coil or Electric or Gas [On] Hot water coil or Electric or Gas then Heat Pump	3332 <b>(BMS)</b>
09H	9	R/W	L	[Enable] Run eco: [On] the Economiser is running, [Off] the Economiser if stopped.	3353 <b>(BMS)</b>
0AH	10	R/W	L	[Enable] Run CO2 Sensor: [On] Switch-on the CO2 control on a Zone, [Off] Stop the CO2 control on a zone.	3354 <b>(BMS)</b>
0BH	11	R/W	L	[Enable] [OFF] Force the unloading of compressors in cooling mode.	3355 <b>(BMS)</b>
0CH	12	R/W	L	[Enable] [OFF] Force the unloading of compressors in heating mode.	3356 <b>(BMS)</b>
0DH	13	R/W	L	[Enable] [OFF] Force the unloading of heating module (electric, gas or heat water coil)	3357 <b>(BMS)</b>
0EH	14	R/W	L	[Enable] [OFF] Force the unloading of humidity control.	3358 <b>(BMS)</b>
0FH	15	R/W	L	[Unloaded] Force the stop of half of the compressors moving has the moment of the activation of this point.	3643
10H	16	R/W	L	[Clock] [OFF] read hour & minute [ON] write hour & minute	...
11H	17	R/W	L	[Dry contact] Digital Output, Free 1, BM50-J17-NO12	2141
12H	18	R/W	L	[Dry contact] Digital Output, Free 2, BE50-J5-NO1	2142
13H	19	R/W	L	[Dry contact] Digital Output, Free 3, BE50-J6-NO2	2143
14H	20	R/W	L	[Dry contact] Digital Output, Free 4, BE50-J7-NO3	2144
15H	21	R/W	L	[Dry contact] Digital Output, Free 5, BE50-J8-NO4	2145
16H	22	R/W	L	<i>not used</i>	
17H	23	R/W	L	<i>not used</i>	
18H	24	R/W	L	<i>not used</i>	
19H	25	R/W	L	<i>not used</i>	
1AH	26	R/W	L	<i>not used</i>	
1BH	27	R/W	L	<i>not used</i>	
1CH	28	R/W	L	<i>not used</i>	
1DH	29	R/W	L	<i>not used</i>	
1EH	30	R/W	L	<i>not used</i>	
1FH	31	R/W	L	<i>not used</i>	



@ (hexa)	@ (deci)				DS50
20H	32	R/W	L	<i>not used</i>	
21H	33	R	L	[Alarm] General	1000
22H	34	R	L	[On/Off] Fan, Blower	2315
23H	35	R	L	[On/Off] Fan, Extraction	2321
24H	36	R	L	[On/Off] Compressor, 1	2516
25H	37	R	L	[On/Off] Compressor, Heat pump, 1	2517
26H	38	R	L	[On/Off] Compressor, 2	2526
27H	39	R	L	[On/Off] Compressor, Heat pump, 2	2527
28H	40	R	L	[On/Off] Compressor, 3	2536
29H	41	R	L	[On/Off] Compressor, Heat pump, 3	2537
2AH	42	R	L	[On/Off] Compressor, 4	2546
2BH	43	R	L	[On/Off] Compressor, Heat pump, 4	2547
2CH	44	R	L	[On/Off] Gas, Burner, 1	2615
2DH	45	R	L	[On/Off] Gas, Burner, 2	2616
2EH	46	R	L	[On/Off] Gas, Burner, High power, 1	2617
2FH	47	R	L	[On/Off] Electrical heaters, 1	2625
30H	48	R	L	[On/Off] Electrical heaters, 2	2626
31H	49	R	L	[Dry contact] Digital Input, Free 1, BM50-J8-ID13	2151
32H	50	R	L	[Dry contact] Digital Input, Free 2, BM50-J8-ID14	2152
33H	51	R	L	[Dry contact] Digital Input, Free 3, BE50-J4-ID1	2153
34H	52	R	L	[Dry contact] Digital Input, Free 4, BE50-J4-ID2	2154
35H	53	R	L	[Dry contact] Digital Input, Free 5, BE50-J4-ID3	2155
36H	54	R	L	[Dry contact] Digital Input, Free 6, BE50-J4-ID4	2156
37H	55	R	L	<i>not used</i>	
38H	56	R	L	<i>not used</i>	
39H	57	R	L	<i>not used</i>	
3AH	58	R	L	<i>not used</i>	
3BH	59	R	L	<i>not used</i>	
3CH	60	R	L	<i>not used</i>	
3DH	61	R	L	<i>not used</i>	
3EH	62	R	L	[Room] Cool Mode	...
3FH	63	R	L	[Room] Deadz one Mode	...
40H	64	R	L	[Room] Heat Mode	...

### Analogical

@ (hexa)	@ (deci)				DS50
01H	1	R/W	1 = 1 s	[ BMS ] Activation of the control by a computer or an automat - mode BMS is activated if this value is different from zero, This value is decreased every second	3934
02H	2	R/W	10 = 1.0°C	[Occupation][Room SP] Required maximum room temperature in °C. Cooling set point	3322 (BMS)
03H	3	R/W	10 = 1.0°C	[Occupation][Room SP] Required minimum room temperature in °C. Heating set point	3323 (BMS)
04H	4	R/W	1 = 1%	[Room SP] Required room minimum fresh air rate in % Middle of the dead zone.	3312 (BMS)
05H	5	R/W	10 = 1.0°C	[Inoccupation][Room SP] Required maximum room temperature in °C. Cooling set point	3322 (Uno)

@ (hexa)	@ (deci)				DS50
06H	6	R/W	10 = 1.0°C	[Inoccupation][Room SP] Required minimum room temperature in °C. Heating set point	3323 (Uno)
07H	7	R/W	1 = 1%	[Humidity] Desired Maximum relative humidity in Room (in %). – Dehumidification set point.	3341 (BMS)
08H	8	R/W	1 = 1%	[Humidity] Desired Minimum relative humidity in Room (in %). – Humidification set point.	3342 (BMS)
09H	9	R/W		<i>not used</i>	
0AH	10	R/W		<i>not used</i>	
0BH	11	R/W		<i>not used</i>	
0CH	12	R/W	1 = 1h	[Clock] Hour	3121
0DH	13	R/W	1 = 1m	[Clock] Minute	3122
0EH	14	R/W	1 = 1	[Clock] Day of the month	3123
0FH	15	R/W	1 = 1	[Clock] Month	3124
10H	16	R/W	1 = 2001	[Clock] Year	3125
11H	17	R/W	10 = 1.0°C	[BMS] Room temperature coming from the BMS	2824
12H	18	R/W	10 = 1.0%	[BMS] Room humidity coming from the BMS	2828
13H	19	R/W	10 = 1.0°C	[BMS] Outdoor temperature coming from the BMS	2814
14H	20	R/W	10 = 1.0%	[BMS] Outdoor humidity coming from the BMS	2818
15H	21	R/W	1 = 1 ppm	[BMS] Air quality coming from the BMS	
16H	22	R/W		<i>not used</i>	
17H	23	R/W		<i>not used</i>	
18H	24	R/W		<i>not used</i>	
19H	25	R/W		<i>not used</i>	
1AH	26	R/W		<i>not used</i>	
1BH	27	R/W		<i>not used</i>	
1CH	28	R/W		<i>not used</i>	
1DH	29	R/W		<i>not used</i>	
1EH	30	R/W		<i>not used</i>	
1FH	31	R/W		<i>not used</i>	
20H	32	R/W		<i>not used</i>	
21H	33	R	1 = 1	[Alarm] Code Error	1000
22H	34	R	10 = 1.0°C	[Temperature] Room	2112
23H	35	R	10 = 1.0°C	[Temperature] Outdoor	2111
24H	36	R	10 = 1.0°C	[Temperature] Supply	2113
25H	37	R	10 = 1.0°C	[Temperature] Return	2114
26H	38	R	10 = 1.0%	[Relative Humidity] Room	2122
27H	39	R	10 = 1.0 g/Kg	[Absolute Humidity] Room	2124
28H	40	R	10 = 1.0%	[Relative Humidity] Outdoor	2121
29H	41	R	10 = 1.0 g/Kg	[Absolute Humidity] Outdoor	2123
2AH	42	R	1 = 1 pa	[Flow] Differential pressure on the air, in pascal	2131
2BH	43	R	1 = 1 ppm	[CO <sup>2</sup> ] Level in ppm	2132
2CH	44	R	1 = 1%	[% of opening] Register of fresh air	2413
2DH	45	R	1 = 1%	[% of opening] Valve gas	2618
2EH	46	R	1 = 1%	[% of opening] Electrical heaters (Triac)	2627
2FH	47	R	1 = 1%	[% of opening] Hot water coil	2633

@ (hexa)	@ (deci)				DS50
30H	48	R	1 = 1%	[% of opening] Humidifier	2714
31H	49	R	10 = 1.0°C	[Dry contact] Temperature, Free 1, BE50-J9-B1	2161
32H	50	R	10 = 1.0°C	[Dry contact] Temperature, Free 2, BE50-J9-B2	2162
33H	51	R	10 = 1.0°C	[Dry contact] Temperature, Free 3, BE50-J10-B3	2163
34H	52	R	10 = 1.0°C	[Dry contact] Temperature, Free 4, BE50-J10-B4	2164
35H	53	R	10 = 1.0%	[Dry contact] Humidity, Free 1, BE50-J9-B1	2165
36H	54	R	10 = 1.0%	[Dry contact] Humidity, Free 2, BE50-J9-B2	2166
37H	55	R	10 = 1.0%	[Dry contact] Humidity, Free 3, BE50-J10-B3	2167
38H	56	R	10 = 1.0%	[Dry contact] Humidity, Free 4, BE50-J10-B4	2168
39H	57	R	1 = 1 h	[Running Time, Count] Fan, Blower	2318
3AH	58	R	1 = 1 h	[Running Time, Count] Compressor, 1	2519
3BH	59	R	1 = 1 h	[Running Time, Count] Compressor, 2	2529
3CH	60	R	1 = 1 h	[Running Time, Count] Compressor, 3	2539
3DH	61	R	1 = 1 h	[Running Time, Count] Compressor, 4	2549
3EH	62	R	bit	[Alarm] bit.0 = Air Flow bit.1 = Dirty Filters bit.2 = No Filters bit.3 = Electrical heaters bit.4 = High Temperature, Supply bit.5 = Low Temperature, Room bit.6 = Gas Burner 1 bit.7 = Gas Burner 2 bit.8 = Low Temperature, Supply bit.9 = High Temperature, Room bit.10 = Humidifier bit.11 = Low Humidity, Room bit.12 = High Humidity, Room bit.13 = Pump bit.14 = Real Time Clock bit.15 = BE50	...
3FH	63	R	bit	[Alarm] bit.0 = Probes & Sensors bit.1 = Fan, Blower bit.2 = Low Temperature, Condenser Water bit.3 = High Temperature, Condenser Water bit.4 = Flow Switch, Condenser Water bit.5 = Smoke Detector bit.6 = Fans, Condenser bit.7 = Compressor 1, H.P. & I.P. bit.8 = Compressor 1, L.P. bit.9 = Compressor 2, H.P. & I.P. bit.10 = Compressor 2, L.P. bit.11 = Compressor 3, H.P. & I.P. bit.12 = Compressor 3, L.P. bit.13 = Compressor 4, H.P. & I.P. bit.14 = Compressor 4, L.P. bit.15 =	...
40H	64	R		<i>not used</i>	

## BMS address table for LonWorks

Type	Index pCO	Name NV	Type NV	Direction	Index pCO
ANL	1	I_Sp_T_Cool_BMS	105	input	1
ANL	1	O_Sp_T_Cool_BMS	105	output	1
ANL	2	I_Sp_T_Heat_BMS	105	input	2
ANL	2	O_Sp_T_Heat_BMS	105	output	2
ANL	3	I_Sp_T_Cool_Uno	105	input	3
ANL	3	O_Sp_T_Cool_Uno	105	output	3
ANL	4	I_Sp_T_Heat_Uno	105	input	4
ANL	4	O_Sp_T_Heat_Uno	105	output	4
ANL	5	I_Sp_Hr_DeHu_BMS	81	input	5
ANL	5	O_Sp_Hr_DeHu_BMS	81	output	5
ANL	6	I_Sp_Hr_Humi_BMS	81	input	6
ANL	6	O_Sp_Hr_Humi_BMS	81	output	6
ANL	17	O_T_Room	105	output	17
ANL	18	O_T_Outside	105	output	18
ANL	19	O_la_T_Supply	105	output	19
ANL	20	O_Hr_Room	81	output	20
ANL	21	O_Ha_Room	23	output	21
ANL	22	O_Hr_Outside	81	output	22
ANL	23	O_Ha_Outside	23	output	23
INT	1	I_Sp_BMS_Dog	8	input	208
INT	1	O_Sp_BMS_Dog	8	output	208
INT	2	I_Sp_EcoMini_BMS	8	input	209
INT	2	O_Sp_EcoMini_BMS	8	output	209
INT	3	I_Hour	8	input	210
INT	3	O_Hour	8	output	210
INT	4	I_Minute	8	input	211
INT	4	O_Minute	8	output	211
INT	5	I_Day	8	input	212
INT	5	O_Day	8	output	212
INT	6	I_Month	8	input	213
INT	6	O_Month	8	output	213
INT	17	O_Error_Codes	8	output	224
INT	18	O_Oa_Eco	81	output	225
INT	19	O_Oa_GasHeat	81	output	226
INT	20	O_Oa_TriacHeat	81	output	227
INT	21	O_Oa_HotWater	81	output	228
DGT	1	I_Sp_On_Unit	95	input	415
DGT	1	O_Sp_On_Unit	95	output	415
DGT	2	I_Sp_Reset	95	input	416
DGT	2	O_Sp_Reset	95	output	416
DGT	3	I_Sp_Unoc	95	input	417
DGT	3	O_Sp_Unoc	95	output	417
DGT	4	I_Clock	95	input	418
DGT	17	O_Od_Alarm	95	output	431
DGT	18	O_Od_Blower	95	output	432
DGT	19	O_Od_Comp_1	95	output	433
DGT	20	O_Od_CPac_1	95	output	434
DGT	21	O_Od_Comp_2	95	output	435
DGT	22	O_Od_CPac_2	95	output	436
DGT	23	O_Od_Comp_3	95	output	437

	DS50
[Occupation][Room SP] Required maximum room temperature in °C. Cooling set point	<b>3322 (BMS)</b>
[Occupation][Room SP] Required minimum room temperature in °C. Heating set point	<b>3323 (BMS)</b>
[Inoccupation][Room SP] Required maximum room temperature in °C. Cooling set point	<b>3322 (Uno)</b>
[Inoccupation][Room SP] Required minimum room temperature in °C. Heating set point	<b>3323 (Uno)</b>
[Humidity] Desired Maximum relative humidity in Room (in %). – Dehumidification set point.	<b>3341 (BMS)</b>
[Humidity] Desired Minimum relative humidity in Room (in %). – Humidification set point.	<b>3342 (BMS)</b>
[Temperature] Room	<b>2112</b>
[Temperature] Outdoor	<b>2111</b>
[Temperature] Supply	<b>2113</b>
[Relative Humidity] Room	<b>2122</b>
[Absolute Humidity] Room	<b>2124</b>
[Relative Humidity] Outdoor	<b>2121</b>
[Absolute Humidity] Outdoor	<b>2123</b>
[ BMS ] Activation of the control by a computer or an automat - mode BMS is activated if this value is different from zero, This value is decreased every second	<b>3932</b>
[Room SP] Required room minimum fresh air rate in % Middle of the dead zone.	<b>3312 (BMS)</b>
[Clock] Hour	<b>3121</b>
[Clock] Minute	<b>3122</b>
[Clock] Day of the month	<b>3123</b>
[Clock] Month	<b>3124</b>
[Alarm] Code Error	<b>1000</b>
[% of opening] Register of fresh air	<b>2413</b>
[% of opening] Valve gas	<b>2618</b>
[% of opening] Electrical heaters (Triac)	<b>2627</b>
[% of opening] Hot water coil	<b>2633</b>
[On / Off] Unit	<b>3111</b>
[Reset] Discharges the safety measures of the unit	<b>3112</b>
[BMS] Activation of the Inoccupation mode [Off] occupation mode - [On] inoccupation mode	<b>3933</b>
[Clock] [OFF] read hour & minute [ON] write hour & minute	...
[Alarm] General	<b>1000</b>
[On/Off] Fan, Blower	<b>2315</b>
[On/Off] Compressor, 1	<b>2516</b>
[On/Off] Compressor, Heat pump, 1	<b>2517</b>
[On/Off] Compressor, 2	<b>2526</b>
[On/Off] Compressor, Heat pump, 2	<b>2527</b>
[On/Off] Compressor, 3	<b>2536</b>

Type	Index pCO	Name NV	Type NV	Direction	Index pCO
DGT	24	O_Od_CPac_3	95	output	438
DGT	25	O_Od_Comp_4	95	output	439
DGT	26	O_Od_CPac_4	95	output	440
DGT	27	O_Od_GasHeat_11	95	output	441
DGT	28	O_Od_GasHeat_2	95	output	442
DGT	29	O_Od_GasHeat_12	95	output	443
DGT	30	O_Od_ElecHeat_1	95	output	444
DGT	31	O_Od_ElecHeat_2	95	output	445

	DS50
[On/Off] Compressor, Heat pump, 3	<b>2537</b>
[On/Off] Compressor, 4	<b>2546</b>
[On/Off] Compressor, Heat pump, 4	<b>2547</b>
[On/Off] Gas, Burner, 1	<b>2615</b>
[On/Off] Gas, Burner, 2	<b>2616</b>
[On/Off] Gas, Burner, High power, 1	<b>2617</b>
[On/Off] Electrical heaters, 1	<b>2625</b>
[On/Off] Electrical heaters, 2	<b>2626</b>



[www.lennox europe.com](http://www.lennox europe.com)

Due to Lennox's ongoing commitment to quality, the Specifications, Ratings and Dimensions are subject to change without notice and without incurring liability.

Improper installation, adjustment, alteration, service or maintenance can cause property damage or personal injury.

Installation and service must be performed by a qualified installer and servicing agency.

**CL50-ROOFTOP-IOM-1107-E**

