

USER MANUAL

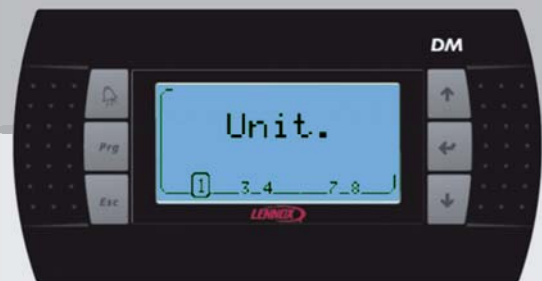

DC & DM displays

**BALTIC
FLEXAIR
ENERGY**

**AIRCOOLAIR
COMPACTAIR
FLATAIR
AQUALEAN**

DC-DM-IOM-1801-E



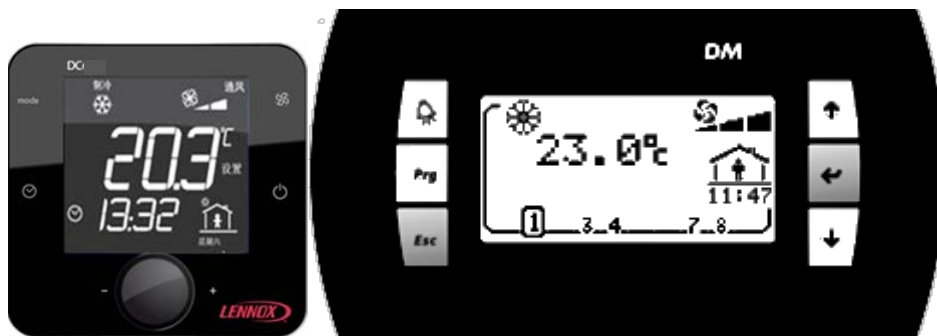

Summaries

1	Display 'DC'	
1.1	Introduction	2
1.2	Temperature measurement	2
1.3	Quick Action	3
1.4	Presentation	6
1.5	Use	7
1.6	DC set in 'Light' mode	8
1.7	DC set in 'Full' mode	9
1.8	Setting Value	11
1.9	Activation level 2	11
2	Display 'DM'	
2.1	Quick Action	12
2.2	Functionality of the DM	14
2.3	Organizational screens	21
3	DC, Installation	
3.1	Connection	23
3.2	Ferrites Protection of Displays	25
3.3	Temperature Sensor	25
3.4	Configuration	25
3.5	Initialization	26
4	'DM', Installation	
5.1	Connection	27
4.2	Connection on the splitter DT50	28
4.3	Ferrites Protection of Displays	28
4.4	Configuration	29
5	DC-DM Communication Master/Slaves	
6.1	Connection	30
7	ALARM LIST	31

1 Display 'DC'



1.1 Introduction

The display 'DC' is customized for the user.

It allows an overview of the operation of the Unit and allows access to some parameters.

Depending on the setting in the Climatic, two display configurations are possible:

- Mode 'Light'
- Mode 'Full'

The 'DC' is designed to be remotely connected of the Unit.

The 'DC' is equipped with a temperature sensor.

The temperature sensor allows the acquisition of room temperature to control.

1.2 Temperature measurement

All Lennox Unit comes with a temperature sensor; it must be placed in the conditioned area.

But if the 'DC' is placed in the area conditioned by the Unit, it is possible, in this case, to use the temperature measurement of the 'DC'.

1.3 Quick Action

1.3.1 How to See the Operation of the Unit 4 ?

Only if several units are connected to the DC.

Turn the knob to have the text 'Unit'.

Press the knob to switch in 'Set' mode.

Turn the knob to select number 4.

Press the knob to confirm your choice



1.3.2 How to Start all Units connected at this DC ?



Press the button  a few seconds.



The units can not be powered On/Off by the DC if the service display DS is connected.



1.3.3 How to Start Unit 4 ?

Only if several units are connected to the DC.

Select the Unit 4 (see: How to See the Operation of the Unit 4 ?)

Turn the knob to have the text 'I-O'.



Press the knob to switch in 'Set' mode.



Turn the knob to select number 1 (1 for 'On', 0 for 'Off').



Press the knob to confirm your choice



The units can not be powered On/Off by the DC if the service display DS is connected.



1.3.4 How to See the Value of the Current Setpoint Temperature ?

Turn the knob to have the text 'Set'.

The value displayed is the temperature setpoint.



1.3.5 How to Modify the Value of the Current Setpoint Temperature ?

Turn the knob to have the text 'Set'.



Press the knob to switch in 'Set' mode.



Turn the knob to change the value.



Press the knob to confirm your choice



1.4 Presentation

1.4.1 Showing

Control operating mode
| ☀ Heat. | ❄ Cool. | Auto |

Fan operating mode

Value

Label or Clock

Status

- 🔔 Alarm
- 🌀 Pump
- ⚙ Compressor(s)
- ❄ Defrost
- ❄ Condenser(s)
- 🔥 Heaters

Hidden: to stop
Visible: running
Blinking: in fault

Schedule mode

- 🏠 Day
- 🏠 Day I
- 🏠 Day II
- 🏠 Night
- BMS

1.4.2 Buttons

Control Not t

Ventilation Not .

Clock
Viewing or setting the time

Standby

Knob
Select or set of values

1.5 Use

mode

1.5.1 Control operating mode.

Only for Flatair and Aqualean ranges.



Press until the desired operating mode is displayed.



Heating mode



Cooling mode

Auto

Automatic mode



1.5.2 Fan Speed Management.

Only for Flatair and Aqualean ranges.



Press to select the desired speed (min, med, max) or automatic (Auto).



Minimum speed



Median speed



Maximum speed

Auto

Automatic Speed



1.5.3 On/Off unit

By supporting a few seconds, the button  you can activate or not (On/Off) the Unit connected.

If the symbol **OFF** completed by the time  is displayed, the Unit is stopped and the 'DC' in sleep mode.

To restart the unit, press the button  a few seconds



If the DC is used with the Master/Slaves bus in this case, the 'Off' phase, stops all Rooftop connected on the Bus, 'On' phase restarts all.

1.5.4 Setting time

At initialization of the 'DC', the CLIMATIC are synchronized time and day of week with the clock 'DC'.



To view the clock, briefly, press the button 

To set the clock press the button  a few seconds

The **hour** value, flashes.

Turn the knob  to adjust the desired value.

Press the knob  to select your choice.

Then the **minute** value, flashes.

Turn the knob  to adjust the desired value.

Press the knob  to select your choice.

| *Mon Monday* | *Tue Tuesday* | *Wed Wednesday* | *Thu Thursday* | *Fri Friday* | *Sat Saturday* | *Sun Sunday* |

Then the **weekday** value, flashes.

Turn the knob  to adjust the desired value.

Press the knob  to select your choice.

After a few seconds 'DC' communicates the new time to the CLIMATIC.

1.5.5 Information available

By rotating the knob  you can view or modify the following values:

1.6 DC set in 'Light' mode

Unit **set*** : Unit Index selected by the 'DC'
Set **set** : Volatile temperature set point current mode (°C)
: : Indoor (Room) temperature (°C)
AL - : Alarms code

* : Available if the option is enabled.

set : Adjustable with 'DC'.

1.6.1 *Unit* **Unit selected**

If the DC is used with the Master/Slaves bus this item can select or know the Unit Index selected by the 'DC'.

1.6.2 *SEt* Volatile Temperature set point

This item allows you to view and/or modify the control temperature required for the Unit selected.

If this point is changed, this value is used until the scheduling changes mode (Day, Day I, Day II, Night, BMS).

At each change of the mode, the CLIMATIC sets the value of this set point on the preset value in the mode concerned.

1.6.3 *AL -* Alarms code

This item allows you to view the code of different active alarms on the Unit.

If the Unit isn't in alarm, this item is to 0.

1.6.4 Indoor (Room) temperature

This item indicates the measured air temperature in the room conditioning.

The room temperature isn't available if the CLIMATIC is configured to supply control.

1.7 DC set in 'Full' mode

- *Unit set*: Unit Index selected by the 'DC'
- *I-O set**: On/Off of the Unit selected.
- *SP - t set*: Predetermined temperature set point current mode (°C)
- *SEt set*: Volatile temperature set point current mode (°C)
- *AL - set*: Alarms code
- *t - Ou**: Outdoor temperature (°C)
- *t - Su*: Supply temperature (°C)
- *t - In**: Indoor (Room) temperature (°C)
- *h - In**: Indoor (Room) humidity (%hr)
- *Co2**: Indoor (Room) Air quality (ppm)
- *EcO**: Opening of fresh air damper (%)

* : Available if the option is enabled.

 : Available if the level 2 is activated.

set : Adjustable with 'DC'.

1.7.1 *Unit* Unit connected

This item can select or know the Unit Index selected by the 'DC'.

1.7.2 *I-O* On/Off, Power

If the DC is used with the Master/Slaves bus this item allows you to view and/or change the status of starting or stopping of the Unit selected.

1.7.3 *SEt* Volatile Temperature set point

This item allows you to view and/or modify the control temperature required for the Unit selected.

If this point is changed, this value is used until the scheduling changes mode (A, B, C, D, BMS).

At each change of the mode, the CLIMATIC sets the value of this set point on the preset value in the mode concerned.

1.7.4 *SP - t* **Predetermined Temperature set point**

If level 2 is active, this item allows you to view and/or change the preset temperature control for the active mode.

1.7.5 *AL -* **Alarms code**

This item allows you to view the code of different active alarms on the Unit.
If the Unit isn't in alarm, this item is to 0.

By this item it's possible to reset the alarm activated. To do this set the value of the item to the value 0.

1.7.6 *t - O u* **Outdoor temperature**

This item indicates the measure temperature of the air outside.
The outside temperature isn't available for the WSHP range.

1.7.7 *t - S u* **Supply temperature**

This item indicates the measure of outlet air temperature of the Unit.

1.7.8 *t - I n* **Indoor (Room) temperature**

This item indicates the measured air temperature in the room conditioning.
The room temperature isn't available if the CLIMATIC is configured to supply control.

1.7.9 *h - I n* **Indoor (Room) relative humidity**

This item shows the measured relative humidity of the air in the room conditioning.
The room humidity isn't available if the option of humidity management isn't set.

1.7.10 *[o 2* **Measurement of CO²**

This item indicates the measured rate of CO² in conditioning room, in ppm.
The measurement of CO² isn't available if the option isn't set.

1.7.11 *E c o* **Opening of fresh air damper**

This item indicates the measured value of the opening rate of the fresh air damper, in%, (mixture of outside air and return air)

This value is only available if the Unit is equipped with this option.

1.8 Setting Value

If the value of the selected item is modified **set**.

To activate the modified value

Press the knob .

The **set** symbol appears on the right side of the value.

Turn the knob  to adjust the desired value.

Press again on the knob  to confirm your choice.



The **set** symbol is no longer displayed on the right side of the value.





The rotation of the knob  is for select a new item.

1.9 Activation level 2



(2 buttons on the right simultaneously)

Simultaneously press the keys  and .

After some seconds the text     appears and the value '000' flashes.

Turn the knob  to change the value to select the number 066. Then validate the code by pressing the knob.

If the code is wrong access the setup menu is not possible and the 'DC' returns to the previous display.

If the code is correct the level 2 is active, and symbol  is displayed to the right of the value.

The level 2 is turned off automatically every hour.

2 Display 'DM'

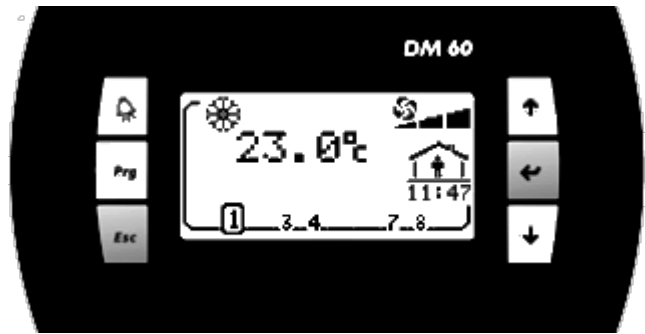

The display 'DM' is customized for the user.
It allows an overview of the operation of the Unit and allows access to some parameters.

The 'DM' is designed to be remotely connected of the Unit.
The 'DM' can be connected to several Lennox Units, Between 1 and 8 units

2.1 Quick Action

2.1.1 How to See the Operation of the Unit 4 ?

Press, several times, the button 'Esc' to display the page 'Unit'.



Press, several times, the button 'Down' to select number 4



Press 'Enter' to confirm your choice



Display for a unit to 'On'



Display for a unit to 'Off'

2.1.2 How to Start Unit ?



Press 'Prg' to activate the setup menu

If necessary, press several times 'Up' or 'Down' to blacken the icon 

Press 'Enter' to confirm your choice

Press 'Up' or 'Down' to change the state 'Off' to 'On'

Press 'Enter' to confirm your choice

Press 'Esc' to return to the main screen



The units can not be powered On/Off by the DM if the service display DS is connected.



2.1.3 How to See the Value of the Current Setpoint Temperature ?



Press 'Prg' to activate the setup menu

If necessary, press several times 'Up' or 'Down' to blacken the icon 

The value displayed is the temperature setpoint.

Press 'Esc' to return to the main screen



2.1.4 How to Modify the Value of the Current Setpoint Temperature ?



Press 'Prg' to activate the setup menu

If necessary, press several times 'Up' or 'Down' to blacken the icon 

Press 'Enter' to confirm your choice

Press 'Up' or 'Down' to change the value

Press 'Enter' to confirm your choice

Press 'Esc' to return to the main screen

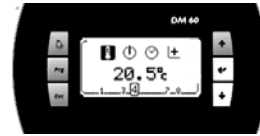

2.2 Functionality of the DM

2.2.1 Selection of Unit

A DM can be connected to **8 units** on the pLAN bus. Screens DM connected, alternatively, to one of BM. The next screen allows selection of the unit to display:



Each of the 8 Unit is represented by a number.

The Unit selected is indicated by its number which is framed.

Each time you press the button 'Down Arrow' connects the display on the next Unit.

Button 'Enter': Go to main screen.

Button 'Down Arrow': Select the next Unit.

2.2.2 Unit 'Off'

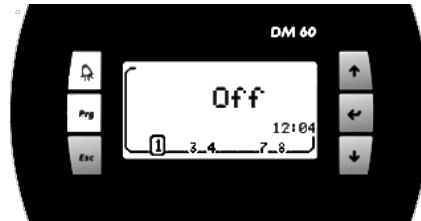

If the Unit is stopped 'Off', this screen is activated.

Button 'Alarm': Go to Alarm list.

Button 'Prg': Go to Setup menus of the unit.



Button 'Esc': Return to the choice of Unit selected.

2.2.3 Unit Operation

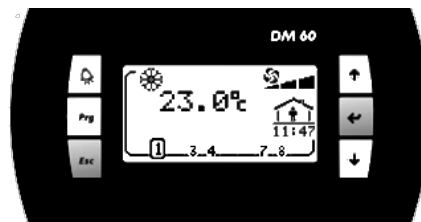
2.2.3.1 Main



Top left :

 Control in heating mode or  control in cooling mode

Big, numerical value: Measured value of the air temperature in the conditioned space.

Top right:

 State of the ventilation

Bottom right:

Mode state based on the schedule, hour, minute, of Climatic™ :



Mode Night



Mode Day



Mode Day I



Mode Day II

Bottom left:

 If the unit is in alarm, this symbol is displayed.

Button 'Alarm': Go to Alarm list.

Button 'Prg': Go to Setup menus of the unit.

Button 'Esc': Return to the choice of Unit selected.

Button 'Up Arrow': Go to another display of the Unit operation.

Button 'Down Arrow': Go to another display of the Unit operation.

2.2.3.2 Value

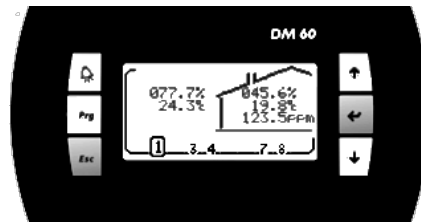

To the left of the house:
 Visualization of the value of outdoor humidity (if enabled).
 Visualization of the value of outdoor temperature.
 In the house:
 Visualization of the value of indoor humidity (if enabled).
 Visualization of the value of the indoor temperature.
 Visualization of the value of the rate of indoor air quality (if enabled).

2.2.3.3 Set-points



☀ Visualization of the set point of heating mode.
 ❄ Visualization of the set point of cooling mode.

2.2.3.4 Operation



🔧 Visualization of the opening percentage of fresh air damper.
 🌀 Visualization of the percentage of compressors engaged.
 🔥 Visualization of the percentage of heaters engaged.

- Button 'Alarm': Go to Alarm list.
- Button 'Prg': Go to Setup menus of the unit.
- Button 'Esc': Return to main screen.
- Button 'Up Arrow': Go to previous display of the Unit operation.
- Button 'Down Arrow': Go to next display of the Unit operation.

2.2.4 Alarm list

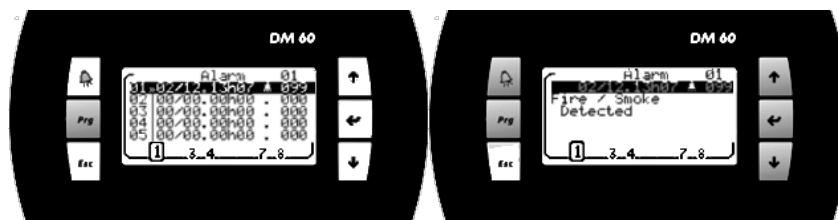

History used to store the last 99 alarms occurred on the unit.
 Each alarm is stored on the date and time the fault occurred.
 An active alarm is signified by the symbol 'Bell'.
 An alarm not active is signified by the symbol '!'.
 Each alarm is signified by a 3 digit code

To have the text of fault code, position the cursor on the desired line, by using the 'Up Arrow' or 'Down Arrow' and then confirm by pressing 'Enter'

Button 'Esc': Return to main screen.

Button 'Up Arrow': Positions you in the list.

Button 'Enter': Go to text of failure code.

Button 'Down Arrow': Positions you in the list.

2.2.5 Setup menus



Button 'Alarm': Go to Alarm list.

Button 'Esc': Return to main screen.

Button 'Up Arrow': Selects the previous function.

Button 'Enter': Go to the screen of the selected function.

Button 'Down Arrow': Selects the next function.

2.2.6 Setting; Customer Temperature



View and/or modify the offset, or set point, of the temperature control desired for the Unit selected.

If the set-point is changed, this value is maintained as long as the scheduling of Unit doesn't change modes (Night, Day, Day I, Day II, BMS).

At each change of the mode the CLIMATIC sets the value of this set-point on the preset value in the mode concerned.

Button 'Alarm': Go to Alarm list.

Button 'Esc': Return to Setup menus of the unit.

Button 'Up Arrow': Increases the set-point value.

Button 'Enter': Valid the changes then return to Setup menus of the unit.

Button 'Down Arrow': Decreases the set-point value.

2.2.7 Setting; On/Off Unit

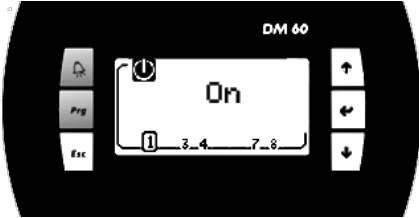

View/edit, status of Off/On of the unit.

Button 'Alarm': Go to Alarm list.

Button 'Esc': Return to Setup menus of the unit.

Button 'Up Arrow': Reverses the state.

Button 'Enter': Valid the changes then return to Setup menus of the unit.

Button 'Down Arrow': Reverses the state.

 The units can not be powered On/Off by the DM if the service display DS0 is connected.

2.2.8 Setting; Clock of Climatic™



View/edit, hour, minute, day of month, month and year of the clock Climatic™.

Button 'Alarm': Go to Alarm list.

Button 'Esc': Return to Setup menus of the unit.

Button 'Up Arrow': Increases the selected value.

Button 'Enter': Valid the changes and puts you to the next field.

Button 'Down Arrow': Decreases the selected value.

2.2.9 Access to the Setup Menus Plus

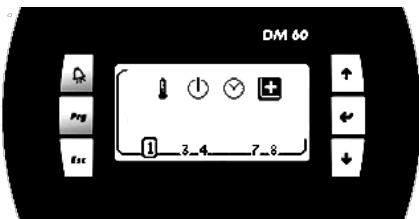

2.2.10 Setup menus Plus

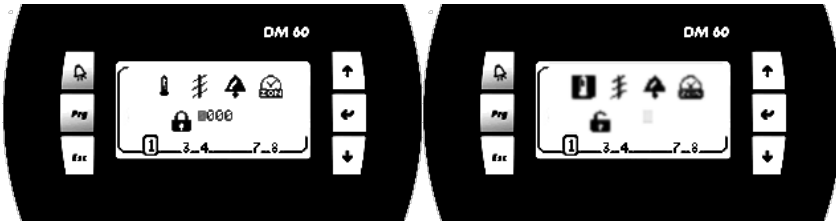

Access to the setup menus is protected by a password.

The password must be entered digit by digit.

If the password is correct, the lock opens, and the selection of the choice of function is active.

Button 'Alarm': Go to Alarm list.

Button 'Esc': Return to Setup menus of the unit.

Button 'Up Arrow': Increases the value of the digit password or Selects the previous function.

Button 'Enter': Puts you on the next digit password, or Go to the screen of the selected function.

Button 'Down Arrow': Decreases the value of the digit password or Selects the next function.

2.2.11 Setting; Temperature



 View/edit, the set-point heating mode of the schedule mode selected.

 View/edit, the set-point cooling mode of the schedule mode selected.

Button 'Alarm': Go to Alarm list.

Button 'Esc': Return to Setup menus Plus of the unit.

Button 'Up Arrow': Change the schedule mode or Increases the set-point value.

Button 'Enter': Valid the changes and puts you to the next field.

Button 'Down Arrow': Change the schedule mode or Decreases the set-point value.

2.2.12 Setting; Report Minimum Fresh-Air.



View/edit, the set-point minimum fresh-air of the schedule mode selected.

Button 'Alarm': Go to Alarm list.

Button 'Esc': Return to Setup menus Plus of the unit.

Button 'Up Arrow': Change the schedule mode or Increases the set-point value.
 Button 'Enter': Valid the changes and puts you to the next field.
 Button 'Down Arrow': Change the schedule mode or Decreases the set-point value.

2.2.13 Setting; Reset Alarms

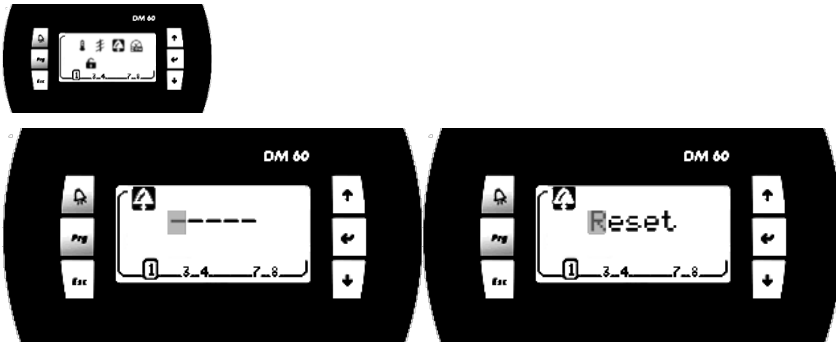

View/edit, reset of alarm and safety.

Button 'Alarm': Go to Alarm list.
 Button 'Esc': Return to Setup menus Plus of the unit.
 Button 'Up Arrow': Reverses the state.
 Button 'Enter': Reset alarms, if the word 'Reset' is selected, then return to Setup menus Plus.
 Button 'Down Arrow': Reverses the state.

2.2.14 Setting; Schedule of Climatic™

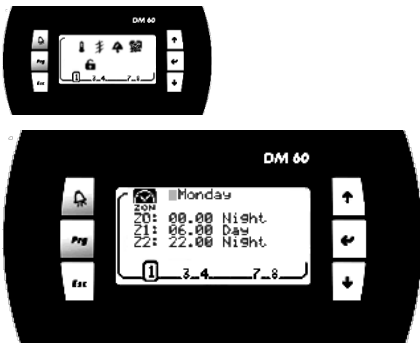

View/edit, hour and minutes of beginning of each zone.
 View/edit, the operating mode of the zone.

The schedule is different each weekday.
 You must set a schedule for Monday, Tuesday, ..., and Sunday.

Button 'Alarm': Go to Alarm list.
 Button 'Esc': Return to Setup menus Plus of the unit.
 Button 'Up Arrow': Change the schedule mode or Increases the selected value.
 Button 'Enter': Valid the changes and puts you to the next field.
 Button 'Down Arrow': Change the schedule mode or Decreases the selected value.

2.3 Organizational screens

2.3.1 Selection of Unit



2.3.2 Unit Operation

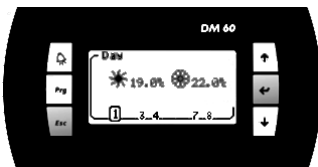
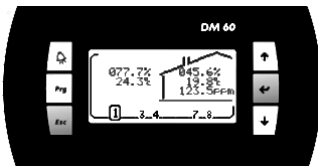
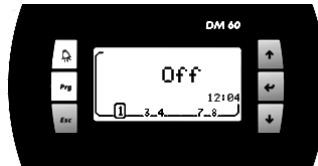

2.3.3 Alarm list

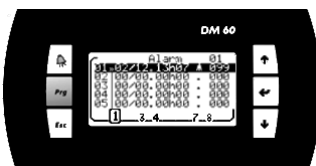

2.3.4 Setup menus

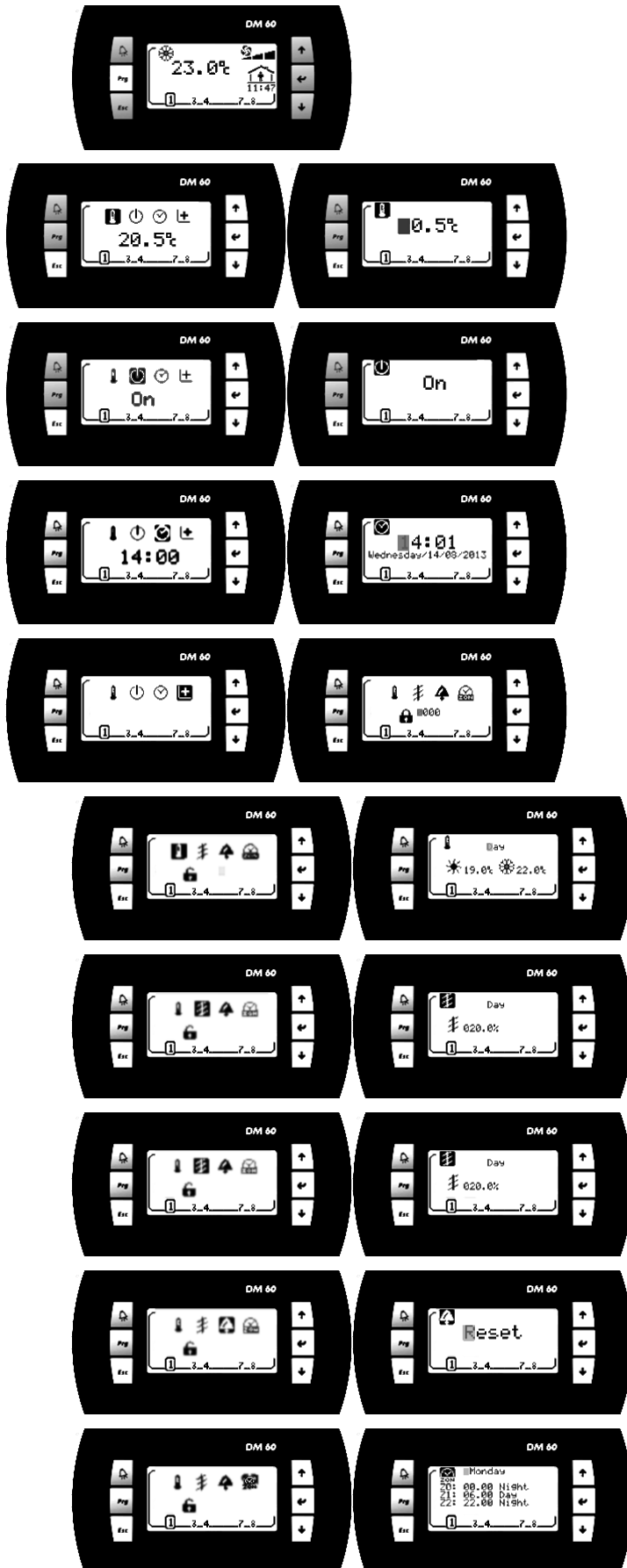

3 DC, Installation

The 'DC' has been designed for flush mount assembly, on distribution boxes compliant with the standards in force.

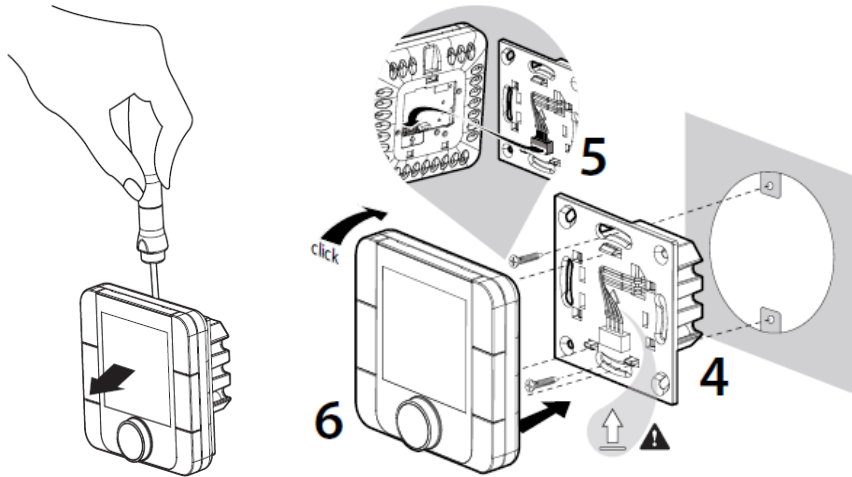

3.1 Connection

WARNING: Separate as much as possible probes, displays, logical input cables from power cables with strong inductive load, in order to avoid possible electromagnetic perturbations.

3.1.1 Important warning

An error connecting to the display immediately causes the deterioration of this one or BM.

Any wiring modification on the CLIMATIC must be done by Lennox technician or employees having valid electrical qualification and authorization.

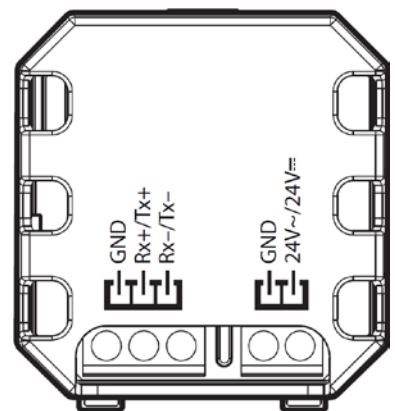

3.1.2 Power supply

The power of the 'DC' can be 24Vac (+10...-15%) 50/60Hz or 24Vdc (22...35Vdc), maximum current of 2VA.

Lennox recommends a 24Vac supply (provided by Unit) for installation of the display less within 30 meters of Unit. For connection of the display of over 30 meters, a power supply, close to the display, 24Vac must be provided by the installer.

For an external connection to the Unit (24V) using a transformer class 2 under 0.1A

For any modification of wiring on the 24V supply or on 4-20mA sensor, check the polarity prior to apply the power. Wrong polarity may cause serious damage and destroy the Plan network. Lennox will not accept liability for damage caused by wrong power connection or any wiring modification done by people without valid training and qualifications.

3.1.3 Communication

The 'DC' is controlled by a communication bus: RS485 2 wires.

3.1.4 Cable Features

The connection of power and communication must be made by the following cable:

- LiYCY-P (0.34 mm²), 2 pairs with general shield.

The cable length, with power, should not exceed 30m.

The cable length without power (24V external) must not exceed 150m.

For a better electromagnetic protection, Lennox recommends the use of LiYCY-P cable

For extended networks fit a 120 Ohm resistor (R2) between RX/TX+ and RX/TX- on the last device, to avoid possible communication problems.

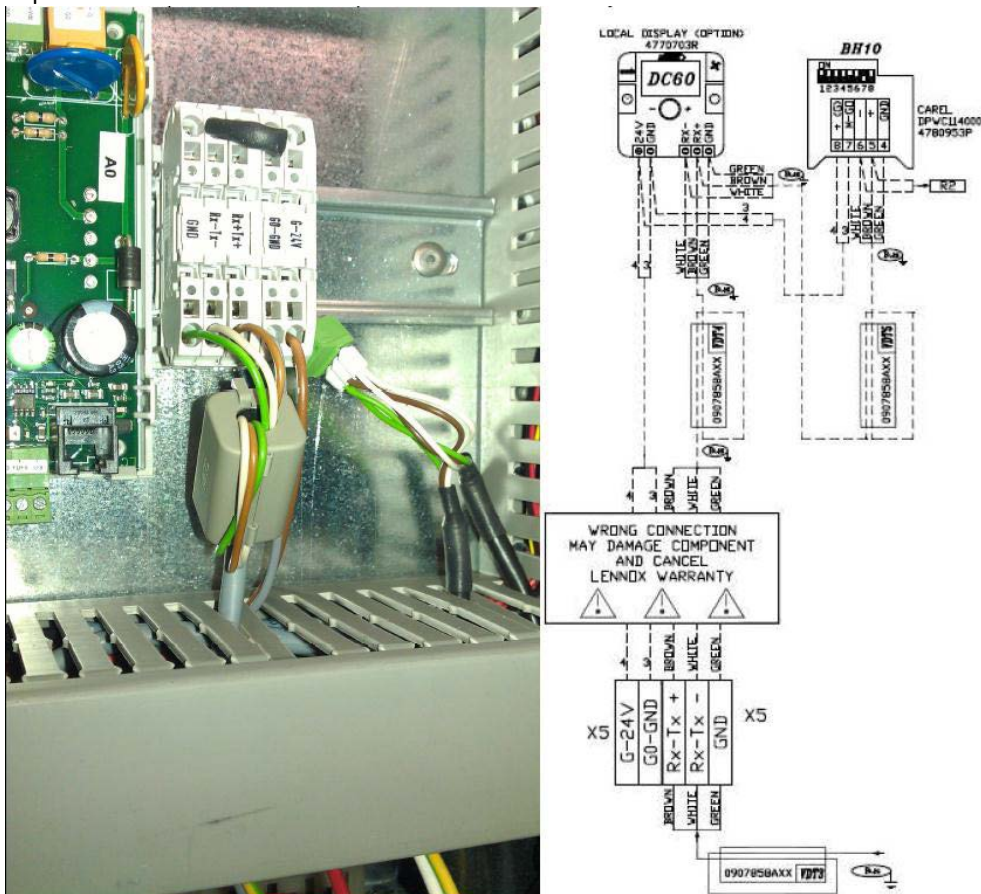

3.2 Ferrites Protection of Displays

To prevent radio interference that may cause miscommunication or destruction of elements on the screen, you need to equip each end of the cable a ferrite (supplied by Lennox).

3.3 Temperature Sensor

All Lennox Unit comes with a temperature sensor; it must be placed in the conditioned area.

But if the 'DC' is placed in the area conditioned by the Unit, it is possible, in this case, to use the temperature measurement of the 'DC'.

To indicate the CLIMATIC your choice, set the point 3213:

- '128' to use the measure of the 'DC'
- '1 BM-B12' or '2 BM-B1' to use the remote probe

Note:

- For Unit with a 'medium' CLIMATIC :
Connect the remote sensor between points B12 and GND, terminal block J18.
- For Unit with a 'small' CLIMATIC:
By default the CLIMATIC control the temperature measurement of return. If you want to control on a measure of room temperature, disconnect the return probe between points B1 and GND, terminal block J13.
Connect the remote sensor in place.



3.4 Configuration

For communicate with the CLIMATIC this basic parameters of internal 'DC' must to be settled.

3.4.1 Setup Menu



(2 buttons on the right simultaneously)

To do this, when the 'DC' is powered; simultaneously press the keys  and .

After some seconds the text *C o d E* appears and the value '000' flashes

Turn the knob  to change the value to select the number 022. Then validate the code by pressing the knob.

If the code is wrong access the setup menu is not possible and the 'DC' returns to the previous display.

If the code is correct the display shows *R d d r*

3.4.2 Choice of Parameters

By rotating of the knob  you can view and modify the following parameters:

- *A d d r*: Address 'DC' on the communication bus (Always set to value **31**)
- *b R u d*: Communication speed (always set to value **2**)
- *b L b E*: Backlight mode
- *b L I n*: Intensity of the backlight
- *P C a L*: Probe calibration
- *C n S t*: Screen contrast
- *b u _ d*: Disabling 'Bip' keys
- *P S u l*: Password (Always set to value **22**)
- *Y E a r*: Real Time Clock 'DC'; Year
- *M o n t h*: Real Time Clock 'DC'; Month
- *d a y*: Real Time Clock 'DC'; Day
- *w d a y*: Real Time Clock 'DC'; weekday (1 = Monday)
- *H o u r*: Real Time Clock 'DC'; Hour
- *m i n*: Real Time Clock 'DC'; Minute
- *E S C*: Exits the Settings mode

3.4.3 Changing the Value of Parameters

To activate the modified mode value:

After to have select the desired parameter by rotating the knob .

Press the knob .

The **set** symbol appears on the right side of the value.

Turn the knob  to adjust the desired value.

Press again on the knob  to confirm your choice.

The **set** symbol is no longer displayed on the right side of the value.

The rotation of the knob  is for select a new setting.

3.4.4 Mandatory values

- *A d d r*: **31**
- *b R u d*: **2**
- *P S u l*: **22**

3.5 Initialization

If the connection between the CLIMATIC and the 'DC is not correct (Offline) screen displays only the symbol *C n*.

In this case check:

- - The connection between CLIMATIC and 'DC'
- - The setting of the 'DC'
- - The power of CLIMATIC

If the connection between the CLIMATIC and the 'DC is correct (Online) to power up the screen displays only the symbol *i n i t*.

This phase allows the CLIMATIC to set up the 'DC' with options of Unit.

After some seconds, DC is operational.

4 'DM', Installation

The "DM" was designed for wall mounting.

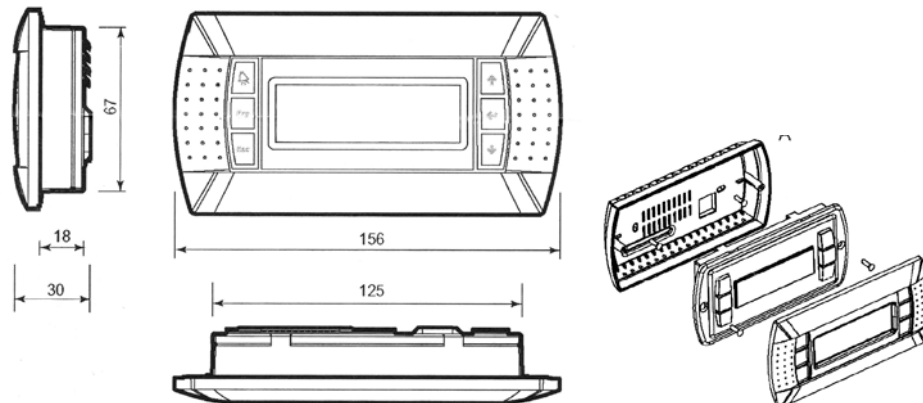

The optional DM delivered is designed to be wall mounted.
Positioning the cable through the rear
Fasten the rear wall using button head screws provided in the package.
Connect the cable from the main board on the jack on the back of the screen DM
Attaching the front panel on the back using countersunk screws provided.
Snap frame.

4.1 Connection

WARNING: Separate as much as possible probes, displays, logical input cables from power cables with strong inductive load, in order to avoid possible electromagnetic perturbations.

4.1.1 Important warning

An error connecting to the display immediately causes the deterioration of this one or BM.

Any wiring modification on the CLIMATIC must be done by Lennox technician or employees having valid electrical qualification and authorization.

4.1.2 Power supply

The 'DM' is powered by the BM.

4.1.3 Communication

The 'DM' is controlled by a communication bus: RS485 2 wires.

4.1.4 Cable Features

The connection of power and communication must be made by the following cable:

- For a length of 0 to 300m: AWG22 (0.34 mm²), two crossed pairs with screen.
- For a length of 0 to 500m: LiYCY-P (0.34 mm²), two pairs shielded general.

The cable length should not exceed 500m.

For better protection of electromagnetic disturbances Lennox recommends the installation of cable LiYCY-P

4.2 Connection on the splitter DT50

The display DM connects to Climatic™ on the screw terminals of the card DT50.

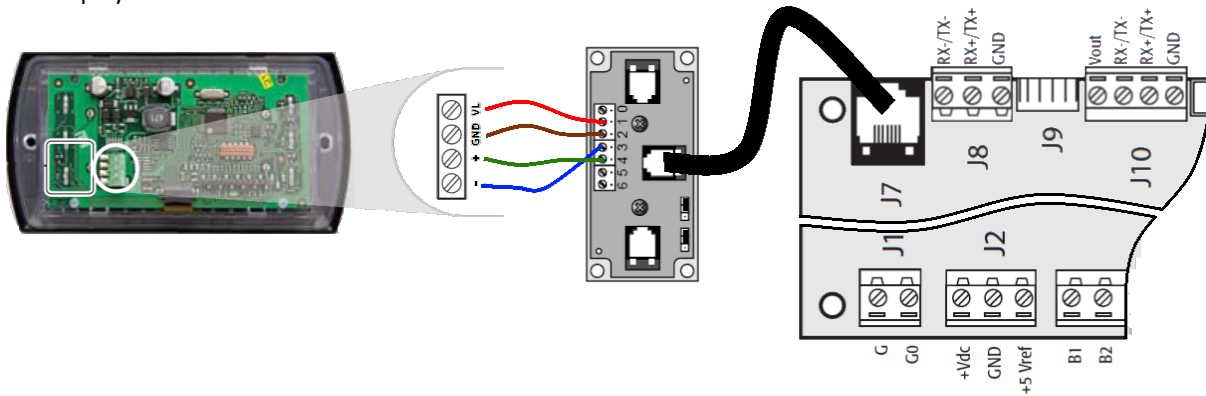

4.2.1 Installation Guide dispatcher DT50

The board is equipped with three RJ12 phone jacks and a screw connector (SC).

terminal	wire function	connections
0	earth	shield
1	+VRL ($\approx 30Vdc$)	1st pair A
2	GND	2nd pair A
3	Rx/Tx-	3rd pair A
4	Rx/Tx+	3rd pair B
5	GND	2nd pair B
6	+VRL ($\approx 30Vdc$)	1st pair B

Jumpers:

The "displays" are directly supplied by the Climatic™ board with a 30 VDC power supply. Pay attention to the value of this voltage when multiple cards are used.

J14 and J15 closed or cut the power supply:

J14 and J15 set between 1-2:

Connectors A, B, C and SC are in parallel. Power is available on all connectors.

J14 and J15 set between 2-3:

B and C connectors are supplied in parallel but the connectors A and SC are not.

Displays connected to these ports are not powered.

If J14 and J15 are set differently, the dispatcher DT50 DOESN'T WORK and therefore displays connected don't work

4.3 Ferrites Protection of Displays

To prevent radio interference that may cause miscommunication or destruction of elements on the screen, you need to equip each end of the cable a ferrite (supplied by Lennox).

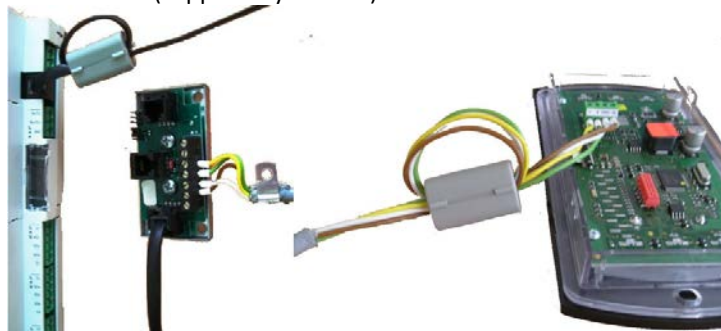

4.4 Configuration

4.4.1 Brightness / Contrast

The display is equipped with a contrast, but it can be adjusted manually. For manual adjustment of contrast, simultaneously press the keys 'Alarm' and 'Prg' and press buttons 'Arrow' or 'Down Arrow' to increase or decrease the contrast.

4.4.2 Configuring the address of the terminal

The address of the terminal (DM) must be checked after putting the card to 'On'.

Access the setup mode by pressing the keys 'Arrow', 'Enter' and 'Down Arrow' for at least 5 seconds.

Press the 'Enter' to place the cursor on the 'Setting'

With the 'Arrow' or 'Down Arrow' set the address of the display 31 of DM, then confirm by pressing 'Enter'

The screen 'Display address changed' is displayed.

If after 5 seconds the display is not correct;

Access, a second time, the setup mode by pressing the keys 'Arrow', 'Enter' and 'Down Arrow' for at least 5 seconds, until the next screen.

Press the 'Enter' to place the cursor on the 'Setting'

Press a second time on the 'Enter' key to place the cursor on the line I / O board address'

With the 'Arrow' or 'Down Arrow' replace '-' by the address of the BM connected and confirm by pressing 'Enter'

5 DC-DM

Communication Master/Slaves

If the communication bus Master/Slaves is connected between several Unit (**Maximum 8**)
The 'DM', connected on this bus, allows viewing, alternatively, information of all connected units.

5.1 Connection

The inter-bus boards (pLan) Climatic™ connects to connector J8 on the BM.
'Star' connection is not recommended for optimum performance. It is advisable to connect a maximum of two cables per unit.

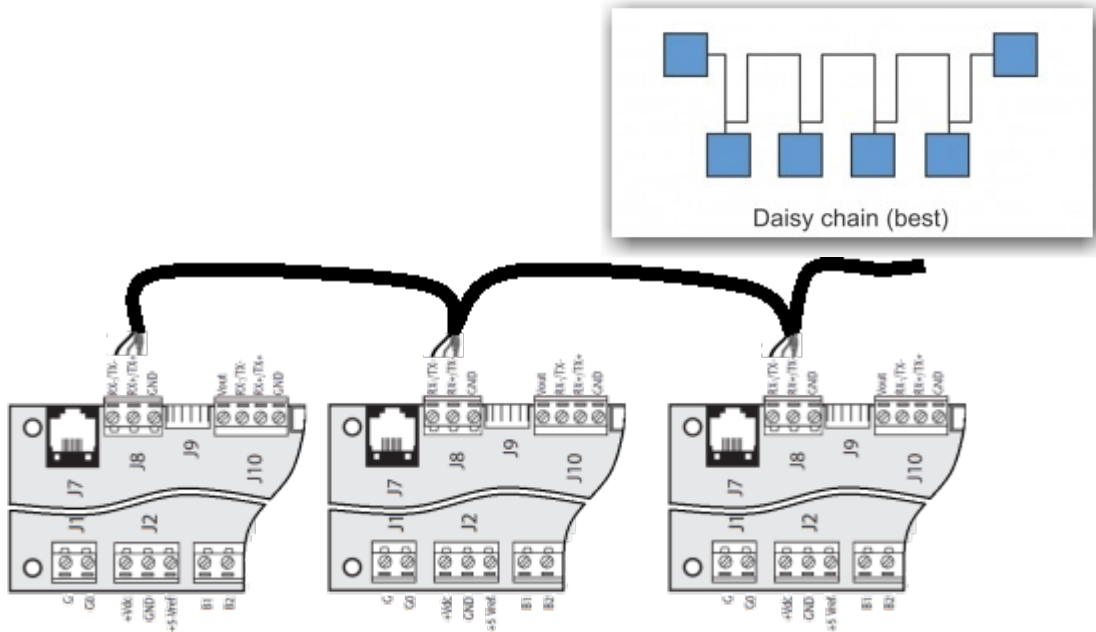

Warning:
The BM 24Vac cards should not be connected to the 'Earth'

5.1.1 Cable Features

The connection must be wired as follows:

- For a length of 0 to 300m: AWG22 (0.34 mm²), a twisted pair shielded.
- For a length of 0 to 500m: LiYCY-P (0.34 mm²), a pair overall shield.

The cable length should not exceed 500m.

For better protection of electromagnetic disturbances Lennox recommends the installation of cable LiYCY-P

5.1.2 Setting

Each Climatic™ must be set with a communication address different.

The address setting must be done with a DS in (3171).

The value of the addresses must be between **1** and **8**

Each Climatic™ must be set with the same number of identification Master (ID).

The ID must be equal to the communication address of the card where the DC is connected.

The ID setting must be done with a DS in (3173).

Each Climatic™ must be set with the same sub-bus identification.

The sub-bus setting must be done with a DS in (3172).

For each Climatic, with a DS, you must set in (3151) the type of remote display, **DC** or **DM**.

ALARM LIST

CODE	DESCRIPTION	CONDITION	EFFECT	RESET	POSSIBLE CAUSES	POSSIBLE REMEDIES	DS MENU
001	Blower, Flow Switch, Cut-off. <i>The differential pressure between the treatment unit and the filters is too small.</i>	Delayed: 1min, Waiting stop: 1min, Enabled: 3min after Blower start.	Full stop.	3/day	<ul style="list-style-type: none"> • Air system obstructed or closed, • Belts broken, • Problem with the fan wiring, • Problem with the pressure transmitter wiring, • Incorrect settings of the safety threshold. 	<ul style="list-style-type: none"> • Check the system, • Replace the belts, • Check the connections, • Check the settings (2333 or 3343). 	[2332] [3342]
002	Water Condenser, Flow Switch Cut Off. <i>The flow switch has detected a low water flow rate in the condenser heat exchanger.</i>	Delayed: 5s, Waiting stop: 1min, Enabled: 5s after one compressor start.	Stop all compressors.	3/day	<ul style="list-style-type: none"> • Problem with the pump control wiring, • Problem with the flow switch wiring, • Dirty or clogged water filter, • Wrong setting of the flow switch. 	<ul style="list-style-type: none"> • Check the pump connections, • Check the flow switch connections, • Clean the water filter, • Check the flow switch settings. 	[2533]
003	Water Condenser, Flow Delta-T. <i>The ΔT(inlet-outlet) of the condenser heat exchanger has too low or too high, detect a low water flow rate.</i>	Threshold: < 1K, > 40K, Delayed: 10min, Waiting stop: 2min, Enabled: 10min after one compressor start.	Stop all compressors.	3/day	<ul style="list-style-type: none"> • Problem with the pump control wiring, • Dirty or clogged water filter. 	<ul style="list-style-type: none"> • Check the pump connections, • Clean the water filter. 	[2531] and [2532]
004	Blower, Filters, Clogged. <i>The differential pressure between the treatment unit and the filters is too high.</i>	Threshold: > [2335][3345], Delayed: 10min, Enabled: 10min after Blower start.	Signalling.	Automatic	<ul style="list-style-type: none"> • Filters clogged, • Problem with the pressure transmitter wiring, • Incorrect settings of the safety threshold. 	<ul style="list-style-type: none"> • Fit new filters, • Clean or replace the filters, • Check the connections, • Check the settings (2335 or 3345). 	[2332] [3342]
004	Blower, Filters, Clogged. <i>Clogged or Missing Filters Alarm keeps active during 168 hours (7 days non stop).</i>	Delayed: 168h.	Full stop.	Manually	<ul style="list-style-type: none"> • Filters clogged, • Problem with the pressure transmitter wiring, • Incorrect settings of the safety threshold. 	<ul style="list-style-type: none"> • Fit new filters, • Clean or replace the filters, • Check the connections, • Check the settings (2335 or 3345). 	[2332] [3342]
005	Blower, Filters, Missing. <i>The differential pressure between the treatment unit and the filters is too low.</i>	Threshold: > [2334][3344], Delayed: 10min, Enabled: 10min after Blower start.	Signalling.	Automatic	<ul style="list-style-type: none"> • Filters missing, • Problem with the pressure transmitter wiring, • Incorrect settings of the safety threshold. 	<ul style="list-style-type: none"> • Fit new filters, • Clean or replace the filters, • Check the connections, • Check the settings (2334 or 3344). 	[2332] [3342]

CODE	DESCRIPTION	CONDITION	EFFECT	RESET	POSSIBLE CAUSES	POSSIBLE REMEDIES	DS MENU
008	Water Condenser, Water Level. <i>Water leak detected by the level detector.</i>	Waiting stop: 1s (Waiting for the closure of the contact), Delayed: 30s.	Stop all compressors.	10/day	<ul style="list-style-type: none"> Leakage on the piping. 	<ul style="list-style-type: none"> Check the piping. 	[2536]
009	Main, Power Supply, Electrical Fault. Main 400V power supply is not present (Customer contact '400V')	Enabled: At power on.	Full stop.	Automatic	<ul style="list-style-type: none"> Main power issue, Wrong setting. 	<ul style="list-style-type: none"> Check the main power tension, Check the settings (3131 to 3147). 	[2181] to [2197]
011	Electrical Heaters, Overheating. <i>The status of the safety thermostat of the main electrical heater signals an overheating on the system.</i>	Delayed: 5s, Enabled: 5s after one electrical heater start.	Stop the electrical heater If [3114] = True: Full stop.	Manually	<ul style="list-style-type: none"> Problem with wiring of the electrical heaters, Air system obstructed or closed, Filter clogged, Belts broken. 	<ul style="list-style-type: none"> Check the connections of the electrical heaters, Check the air system, Clean the filters, Replace the belts. 	[2723]
012	Fresh Air, Electrical Heater, Overheating. <i>The status of the safety thermostat of the Fresh Air electrical heater signals an overheating on the system.</i>	Delayed: 5s, Enabled: 5s after one electrical heater start.	Stop the electrical heater If [3114] = True: Full stop.	Manually	<ul style="list-style-type: none"> Problem with wiring of the electrical heaters, Air system obstructed or closed, Fresh air damper closed, Belts broken. 	<ul style="list-style-type: none"> Check the connections of the electrical heaters, Check the air system, Check air damper, Replace the belts. 	[2882]
013	Hot Water, Risk of Frosting. <i>The safety thermostat of the hot water signals a risk of frosting on the system.</i>	Delayed: 1s.	Full stop.	Manually	<ul style="list-style-type: none"> Check the connections, The fresh air damper is blocked opening. 	<ul style="list-style-type: none"> Check the connections. Check air damper. 	[2733]
014	Gas Burner 1. <i>The gas burner control box has generated a fault and is no longer controlling the fume extractor fan.</i>	Delayed: 5s, Waiting stop: 4min, Enabled: 6min after gas burner requested (10s for eNeRGy).	Stop the gas burner If [3114] = True: Full stop.	3/day	<ul style="list-style-type: none"> Problem with wiring connection, Problem with electronic gaz controller, Problem with gas supply or pressure. 	<ul style="list-style-type: none"> Check the connections. Check gas burner. 	[2713]
015	Gas Burner 2. <i>The gas burner control box has generated a fault and is no longer controlling the fume extractor fan.</i>	Delayed: 5s, Waiting stop: 4min, Enabled: 6min after gas burner requested (10s for eNeRGy).	Stop the gas burner If [3114] = True: Full stop.	3/day	<ul style="list-style-type: none"> Air system obstructed or closed, Filter clogged, Belts broken. 	<ul style="list-style-type: none"> Check the air system, Clean the filters, Replace the belts. 	[2716]

CODE	DESCRIPTION	CONDITION	EFFECT	RESET	POSSIBLE CAUSES	POSSIBLE REMEDIES	DS MENU
016	Gas Burner, Overheating. <i>The status of the safety thermostat signals an overheating on the system.</i>	Delayed: 5s, Enabled: 5s after one gas burner requested.	Stop the gas burner If [3114] = True: Full stop.	Manually	<ul style="list-style-type: none"> • Problem with wiring connection, • Problem with electronic gaz controler, • Problem with gas supply or pressure. 	<ul style="list-style-type: none"> • Check the connections. • Check gas burner. 	#
017	Gas Burner 3. <i>The gas burner control box has generated a fault and is no longer controlling the fume extractor fan.</i>	Delayed: 5s, Waiting stop: 4min, Enabled: 6min after gas burner requested.	Stop the gas burner If [3114] = True: Full stop.	3/day	<ul style="list-style-type: none"> • Problem with wiring connection, • Problem with electronic gaz controler, • Problem with gas supply or pressure. 	<ul style="list-style-type: none"> • Check the connections. • Check gas burner. 	[2781]
018	Gas Burner 4. <i>The gas burner control box has generated a fault and is no longer controlling the fume extractor fan.</i>	Delayed: 5s, Waiting stop: 4min, Enabled: 6min after gas burner requested.	Stop the gas burner If [3114] = True: Full stop.	3/day	<ul style="list-style-type: none"> • Problem with wiring connection, • Problem with electronic gaz controler, • Problem with gas supply or pressure. 	<ul style="list-style-type: none"> • Check the connections. • Check gas burner. 	[2783]
019	Gas Burner 5. <i>The gas burner control box has generated a fault and is no longer controlling the fume extractor fan.</i>	Delayed: 5s, Waiting stop: 4min, Enabled: 6min after gas burner requested.	Stop the gas burner If [3114] = True: Full stop.	3/day	<ul style="list-style-type: none"> • Problem with wiring connection, • Problem with electronic gaz controler, • Problem with gas supply or pressure. 	<ul style="list-style-type: none"> • Check the connections. • Check gas burner. 	[2785]
020	Gas Burner 6. <i>The gas burner control box has generated a fault and is no longer controlling the fume extractor fan.</i>	Delayed: 5s, Waiting stop: 4min, Enabled: 6min after gas burner requested.	Stop the gas burner If [3114] = True: Full stop.	3/day	<ul style="list-style-type: none"> • Problem with wiring connection, • Problem with electronic gaz controler, • Problem with gas supply or pressure. 	<ul style="list-style-type: none"> • Check the connections. • Check gas burner. 	[2787]
021	Supply Temperature, Too High. <i>The temperature measured by the probe is outside of the permitted range.</i>	Threshold: > [3254], Delayed: 5s, Enabled: 2min after Blower start.	Stop all compressors and heaters.	Automatic	<ul style="list-style-type: none"> • Insufficient airflow, • Temperature probe failed, • Problem with wiring of probe, • Wrong setting. 	<ul style="list-style-type: none"> • Check the air system, • Replace probe, • Check the connections of the probe, • Check the setting (3254). 	[2231]
022	Supply Temperature, Too Low. <i>The temperature measured by the probe is outside of the permitted range.</i>	Threshold: < [3252], Delayed: 10min or 5min if Hot Water Coil, Waiting stop: 10min, Enabled: 2min after Blower start.	Full stop.	3/day	<ul style="list-style-type: none"> • Insufficient airflow / Air damper jammed open, • Temperature probe failed, • Problem with wiring of probe, • Wrong setting. 	<ul style="list-style-type: none"> • Check the air system / Check the air damper, mechanically and electrically, • Replace probe, • Check the connections of the probe, • Check the setting (3252). 	[2231]

CODE	DESCRIPTION	CONDITION	EFFECT	RESET	POSSIBLE CAUSES	POSSIBLE REMEDIES	DS MENU
023	Room Temperature, Too High. <i>The temperature measured by the probe is outside of the permitted range.</i>	Threshold: > [3256], Delayed: 15s, Enabled: 2min after Blower start.	Signalling.	Automatic	<ul style="list-style-type: none"> • Insufficient airflow, • Temperature probe failed, • Problem with wiring of probe, • Wrong setting. 	<ul style="list-style-type: none"> • Check the air system, • Replace probe, • Check the connections of the probe, • Check the setting (3256). 	[2221]
024	Room Temperature, Too Low. <i>The temperature measured by the probe is outside of the permitted range.</i>	Threshold: < [3255], Delayed: 15s, Enabled: 2min after Blower start.	Signalling.	Automatic	<ul style="list-style-type: none"> • Insufficient airflow, • Temperature probe failed, • Problem with wiring of probe, • Wrong setting. 	<ul style="list-style-type: none"> • Check the air system, • Replace probe, • Check the connections of the probe, • Check the setting (3255). 	[2221]
025	Water Condenser Temperature, Too Low <i>The temperature measured by the probe is outside of the permitted range.</i>	Threshold: < [3531], Delayed: 15s.	Stop all compressors.	Automatic	<ul style="list-style-type: none"> • Water loop temperature too low, • Wrong setting. 	<ul style="list-style-type: none"> • Wait normal tempetaure conditions, • Check the circuit operating, • Check the setting (3531). 	[2531] or [2532]
026	Water Condenser Temperature, Too High <i>The temperature measured by the probe is outside of the permitted range.</i>	Threshold: > [3532], Delayed: 15s.	Stop all compressors.	Automatic	<ul style="list-style-type: none"> • Water loop temperature too high, • Wrong setting. 	<ul style="list-style-type: none"> • Wait normal tempetaure conditions, • Check the circuit operating, • Check the setting (3532). 	[2531] or [2532]
027	Water Condenser, Pump. <i>The status of the pump signals a failure on the system.</i>	Delayed: 5s.	Stop all compressors.	Manually	<ul style="list-style-type: none"> • Problem with wiring connection, • Pump failure. 	<ul style="list-style-type: none"> • Check the wiring connections, • Check the pump. 	[2535]
029	Air Quality, Too High. <i>The value measured by the sensor is outside of the permitted range.</i>	Threshold: > [3855], Delayed: 15s.	Signalling.	Automatic	<ul style="list-style-type: none"> • Problem with wiring connection (sensor in short circuit or disconnected), • Sensor damaged, • Wrong setting. 	<ul style="list-style-type: none"> • Check the wiring connections, • Replace the sensor, • Check the setting (3855). 	[2853]
031	Humidifier. <i>The status of the humidifier signals a failure on the system.</i>	Delayed: 1min.	Stop the humidifier.	Automatic	<ul style="list-style-type: none"> • Problem with wiring connection. 	<ul style="list-style-type: none"> • Check the wiring connections. 	[2923]
032	Room, Air Hr% or g/kgAS, Too Low. <i>The value measured by the sensor is outside of the permitted range.</i>	Threshold: < [3258], Delayed: 15s, Enabled: 2min after Blower start.	Signalling.	Automatic	<ul style="list-style-type: none"> • Humidity sensor failed, • Problem with wiring of sensor, • Wrong setting. 	<ul style="list-style-type: none"> • Check the wiring connections, • Replace the sensor, • Check the setting (3258) 	[2265] or [2266]
033	Room, Air Hr% or g/kgAS, Too High. <i>The value measured by the sensor is outside of the permitted range.</i>	Threshold: > [3259], Delayed: 15s, Enabled: 2min after Blower start.	Signalling.	Automatic	<ul style="list-style-type: none"> • Humidity sensor failed, • Problem with wiring of sensor, • Wrong setting. 	<ul style="list-style-type: none"> • Check the wiring connections, • Replace the sensor, • Check the setting (3259) 	[2265] or [2266]

CODE	DESCRIPTION	CONDITION	EFFECT	RESET	POSSIBLE CAUSES	POSSIBLE REMEDIES	DS MENU
041	Hot Water, Pump. <i>The electrical protection of the circulator has operated.</i>	Delayed: 15s, Enabled: 5s after pump start	Stop the pump, Close hot water valve.	Manually	<ul style="list-style-type: none"> • Problem with wiring connection, • Pump failure. 	<ul style="list-style-type: none"> • Check the wiring connections, • Check the pump. 	[2744]
051	Recovery, Motor. <i>The status of the wheel recovery motor signals a failure on the system.</i>	Delayed: 10s, Enabled: 30s after motor start.	Stop the motor.	Manually	<ul style="list-style-type: none"> • Problem with wiring connection, • Wheel motor failure. 	<ul style="list-style-type: none"> • Check the wiring connections, • Check the motor. 	[2878]
052	Recovery, Wheel. <i>The ΔT(outdoor-outlet recovery) temperature is lower than the safety limit.</i>	Threshold: < [3874], Delayed: 30s, Waiting stop: 5min, Enabled: 15min after motor start.	Stop the motor.	3/day	<ul style="list-style-type: none"> • Wheel belts broken, • Problem with wiring connection (sensor in short circuit or disconnected), • Sensor damaged, • Wrong setting. 	<ul style="list-style-type: none"> • Replace the belts • Check the wiring connections, • Replace the probes, • Check the setting (3874). 	[2873] or [2875]
054	Recovery, Filters, Clogged. <i>The differential pressure between the treatment unit and the filters is too high.</i>	Threshold: > [3875], Delayed: 1min.	Signalling.	Automatic	<ul style="list-style-type: none"> • Filters clogged, • Problem with the pressure transmitter wiring, • Incorrect settings of the safety threshold. 	<ul style="list-style-type: none"> • Fit new filters, • Clean or replace the filters, • Check the connections, • Check the settings (3875). 	[2876]
056	Recovery, Air Flow, Sensor. <i>The value of the sensor measured is incorrect.</i>	Delayed: 15s.	Stop the motor.	Automatic	<ul style="list-style-type: none"> • Sensor failure, • Problem with wiring of sensor. 	<ul style="list-style-type: none"> • Check the sensor • Check the wiring connections. 	[2876]
059	Recovery, Outlet Temperature, Probe. <i>The value of the probe measured is incorrect.</i>	Delayed: 15s.	Stop the motor.	Automatic	<ul style="list-style-type: none"> • Probe failure, • Problem with wiring of probe. 	<ul style="list-style-type: none"> • Check the probe • Check the wiring connections. 	[2875]
070	CLIMATIC board, Real Time Clock, Battery. <i>The CLIMATIC™ real time clock battery is faulty</i>	Delayed: 1s	Signalling.	Automatic	<ul style="list-style-type: none"> • Battery low voltage 	<ul style="list-style-type: none"> • Replace the clock battery 	#
071	Expansion Board, BE N°1, Link Failure. <i>The expansion board 1 is disconnected from the Fieldbus network.</i>	Delayed: 1s, Enabled: 30s after power on.	Signalling.	Automatic	<ul style="list-style-type: none"> • Expansion board failed, • Problem with wiring of fieldbus, • Wrong setting. 	<ul style="list-style-type: none"> • Replace expansion board, • Check the bus connections, • Check the setting (3121 to 3147). 	#
072	Expansion Board, BE N°2, Link Failure. <i>The expansion board 2 is disconnected from the Fieldbus network.</i>	Delayed: 1s, Enabled: 30s after power on	Signalling.	Automatic	<ul style="list-style-type: none"> • Expansion board failed, • Problem with wiring of fieldbus. 	<ul style="list-style-type: none"> • Replace expansion board, • Check the bus connections 	#

CODE	DESCRIPTION	CONDITION	EFFECT	RESET	POSSIBLE CAUSES	POSSIBLE REMEDIES	DS MENU
073	Blower, Inverter, Link Failure. The EC fans or inverters are disconnected from the Fieldbus network.	Delayed: 30s, Enabled: 30s after power on	Full stop.	Automatic	<ul style="list-style-type: none"> Fans failed, Problem with wiring of fieldbus. 	<ul style="list-style-type: none"> Replace fan, Check the bus connections 	#
074	Exhaust, Inverter, Link Failure. The EC fans or inverters are disconnected from the Fieldbus network.	Delayed: 30s, Enabled: 30s after power on	Full stop.	Automatic	<ul style="list-style-type: none"> Fans failed, Problem with wiring of fieldbus. 	<ul style="list-style-type: none"> Replace fan, Check the bus connections 	#
075	Circuit 1, Condenser Fan, Inverter, Link Failure. The EC fans or inverters are disconnected from the Fieldbus network.	Delayed: 15s, Enabled: 30s after power on	Stop C1 condenser fans, Stop C1 compressors.	Automatic	<ul style="list-style-type: none"> Fans failed, Problem with wiring of fieldbus. 	<ul style="list-style-type: none"> Replace fan, Check the bus connections 	#
076	Circuit 2, Condenser Fan, Inverter, Link Failure. The EC fans or inverters are disconnected from the Fieldbus network.	Delayed: 15s, Enabled: 30s after power on	Stop C2 condenser fans, Stop C2 compressors.	Automatic	<ul style="list-style-type: none"> Fans failed, Problem with wiring of fieldbus. 	<ul style="list-style-type: none"> Replace fan, Check the bus connections 	#
077	Circuit 1, Coompressor, Inverter, Link Failure. The inverter is disconnected from the Fieldbus network.	Delayed: 15s, Enabled: 30s after power on	Stop C1 compressor.	Automatic	<ul style="list-style-type: none"> Driver failed, Problem with wiring of fieldbus. 	<ul style="list-style-type: none"> Replace driver, Check the bus connections 	#
078	Expansion Board, BE N°3, Link Failure. The expansion board 3 is disconnected from the Fieldbus network.	Delayed: 1s, Enabled: 30s after power on.	Signalling.	Automatic	<ul style="list-style-type: none"> Expansion board failed, Problem with wiring of fieldbus. 	<ul style="list-style-type: none"> Replace expansion board, Check the bus connections 	#
079	Expansion Board, eSlave, Link Failure. The eClimatic on internal split unit is disconnected from the Fieldbus network.	Delayed: 1s, Enabled: 30s after power on.	Stop all compressors and heaters.	Automatic	<ul style="list-style-type: none"> Slave eClimatic failed, Problem with wiring of fieldbus. 	<ul style="list-style-type: none"> Replace slave eClimatic, Check the bus connections 	#
080	Blower, Air Flow and Filters, Sensor. The value of the sensor measured is incorrect.	Delayed: 15s.	Full stop.	Automatic	<ul style="list-style-type: none"> Sensor failure, Problem with wiring of sensor. 	<ul style="list-style-type: none"> Check the sensor Check the wiring connections. 	[2332] [3342]
081	Room, Air T°, Probe. The value of the probe measured is incorrect.	Delayed: 15s.	Only ventilation.	Automatic	<ul style="list-style-type: none"> Probe failure, Problem with wiring of probe. 	<ul style="list-style-type: none"> Check the probe Check the wiring connections. 	[2213]

CODE	DESCRIPTION	CONDITION	EFFECT	RESET	POSSIBLE CAUSES	POSSIBLE REMEDIES	DS MENU
082	Room, Air Hr%, Probe. <i>The value of the sensor measured is incorrect.</i>	Delayed: 15s.	Only ventilation.	Automatic	<ul style="list-style-type: none"> • Sensor failure, • Problem with wiring of sensor. 	<ul style="list-style-type: none"> • Check the sensor • Check the wiring connections. 	[2265]
083	Outside, Air T°, Probe. <i>The value of the probe measured is incorrect.</i>	Delayed: 15s.	Only ventilation.	Automatic	<ul style="list-style-type: none"> • Probe failure, • Problem with wiring of probe. 	<ul style="list-style-type: none"> • Check the probe • Check the wiring connections. 	[2211]
084	Outside, Air Hr%, Sensor. <i>The value of the sensor measured is incorrect.</i>	Delayed: 15s.	Only ventilation.	Automatic	<ul style="list-style-type: none"> • Sensor failure, • Problem with wiring of sensor. 	<ul style="list-style-type: none"> • Check the sensor • Check the wiring connections. 	[2261]
085	Supply, Air T°, Probe. <i>The value of the probe measured is incorrect.</i>	Delayed: 5s.	Only ventilation.	Automatic	<ul style="list-style-type: none"> • Probe failure, • Problem with wiring of probe. 	<ul style="list-style-type: none"> • Check the probe • Check the wiring connections. 	[2221]
086	Water Condenser, Inlet, Probe. <i>The value of the probe measured is incorrect.</i>	Delayed: 15s.	Stop all compressors.	Automatic	<ul style="list-style-type: none"> • Probe failure, • Problem with wiring of probe. 	<ul style="list-style-type: none"> • Check the probe • Check the wiring connections. 	[2531]
087	Water Condenser, Outlet, Probe. <i>The value of the probe measured is incorrect.</i>	Delayed: 15s.	Stop all compressors.	Automatic	<ul style="list-style-type: none"> • Probe failure, • Problem with wiring of probe. 	<ul style="list-style-type: none"> • Check the probe • Check the wiring connections. 	[2532]
088	Return Temperature, Probe. <i>The value of the probe measured is incorrect.</i>	Delayed: 15s.	Only ventilation.	Automatic	<ul style="list-style-type: none"> • Probe failure, • Problem with wiring of probe. 	<ul style="list-style-type: none"> • Check the probe • Check the wiring connections. 	[2216]
089	Air Quality, Sensor. <i>The value of the sensor measured is incorrect.</i>	Delayed: 15s, Enabled: 1min after power on.	Signalling.	Automatic	<ul style="list-style-type: none"> • Sensor failure, • Problem with wiring of sensor. 	<ul style="list-style-type: none"> • Check the sensor • Check the wiring connections. 	[2853]
090	Blower Pressure, Sensor. <i>The value of the sensor measured is incorrect.</i>	Delayed: 15s.	Full stop.	Automatic	<ul style="list-style-type: none"> • Sensor failure, • Problem with wiring of sensor. 	<ul style="list-style-type: none"> • Check the sensor • Check the wiring connections. 	[2332] [3342]
091	Blower, Fan. <i>The fan motor control is no longer active.</i>	Delayed: 5s, Enabled: 3min after power on, Enabled: 10s if [3316] = False.	Full stop.	Manually	<ul style="list-style-type: none"> • Electric circuit breaker cut, • Fan motor damaged, • Fire safety thermostat active • Thermal motor protection devices activated, • Problem with wiring connection. 	<ul style="list-style-type: none"> • Check, Replace the fan motor, • Reset the thermostat, • Check the air system, • Check the connection. 	[2313]
092	Blower, Inverter. <i>Alarm reading by bus on fans inverter.</i>	Delayed: 15s, Waiting stop: 30s, Enabled: 15s after one fan start.	Full stop.	3/day	<ul style="list-style-type: none"> • Fan motor damaged, • Thermal motor protection devices activated. 	<ul style="list-style-type: none"> • Check fans motor. 	#

CODE	DESCRIPTION	CONDITION	EFFECT	RESET	POSSIBLE CAUSES	POSSIBLE REMEDIES	DS MENU
093	Exhaust, Fan. <i>The fan motor control is no longer active.</i>	Delayed: 5s, Enabled: 20s after fans start.	Full stop.	Manually	<ul style="list-style-type: none"> • Electric circuit breaker cut, • Fan motor damaged, • Fire safety thermostat active • Thermal motor protection devices activated, • Problem with wiring connection. 	<ul style="list-style-type: none"> • Check, Replace the fan motor, • Reset the thermostat, • Check the air system, • Check the connection. 	[2313]
094	Exhaust, Inverter. <i>Alarm reading by bus on fans inverter.</i>	Delayed: 15s, Waiting stop: 30s, Enabled: 15s after one fan start.	Full stop.	3/day	<ul style="list-style-type: none"> • Fan motor damaged, • Thermal motor protection devices activated. 	<ul style="list-style-type: none"> • Check fans motor. 	#
099	Fire / Smoke, Detected. <i>The stand-alone detector switch (DAD) has detected the presence of smoke in the unit.</i>	Delayed: 1s.	Full stop, Open the fresh air damper.	Manually	<ul style="list-style-type: none"> • Problem with the DAD 	<ul style="list-style-type: none"> • Check the connection. 	[2341]
100	CLIMATIC board, Power Off A long period without power supply has been detected. Time for compressor crankcase to sufficiently warm up enough to avoid refrigerant flooded start.	Threshold: Outside temperature < 10°C, Enabled: If cut-off lasts more than 6 hours at power on.	Stop all compressors.	Automatic 8 hours	<ul style="list-style-type: none"> • Long period without power supply 	<ul style="list-style-type: none"> • Check the unit power-supply 	#
101	EVD N°1, Link Failure. The driver 1 of EEV is disconnected from the Fieldbus network.	Delayed: 30s, Enabled: 1min after power on.	Stop C1 and/or C2 compressors.	Automatic	<ul style="list-style-type: none"> • Driver failed, • Problem with wiring of fieldbus. 	<ul style="list-style-type: none"> • Replace driver, • Check the bus connections 	#
102	Circuit 1, Fan Condenser. <i>The thermal motor protection of the condenser fan has detected an over temperature.</i>	Delayed: 5s, Waiting stop: 30min, Enabled: 5s after fan start.	Stop C1 compressors.	3/day	<ul style="list-style-type: none"> • Electric circuit breaker cut, • Fan motor damaged, • Thermal motor protection devices activated, • Problem with wiring connection. 	<ul style="list-style-type: none"> • Check, Replace the fan motor, • Check the connection. 	[2215]
103	Circuit 1, Fan Condenser Inverter. <i>Alarm reading by bus on fans inverter.</i>	Delayed: 15s.	Stop C1 compressors.	Automatic	<ul style="list-style-type: none"> • Fan motor damaged, • Thermal motor protection devices activated. 	<ul style="list-style-type: none"> • Check fans motor. 	#

CODE	DESCRIPTION	CONDITION	EFFECT	RESET	POSSIBLE CAUSES	POSSIBLE REMEDIES	DS MENU
110	Circuit 1, Leak Refrigerant, Detected. <i>The CLIMATIC has detected a risk of leakage of the refrigerant circuit.</i>	...	Signalling.	Manually	<ul style="list-style-type: none"> Refrigerant leakage 	<ul style="list-style-type: none"> Check the circuit operating 	#
114	Circuit 1, Compressor, Electrical Failure. <i>An electrical failure happened in the compressors of the circuit.</i>	Waiting stop: 30min, Enabled: 5s after one compressor start.	Stop C1 compressors.	3/day	<ul style="list-style-type: none"> Problem with wiring connection, pressure switch or compressor internal safety switch Coil condenser dirty, Fan condenser not operating. 	<ul style="list-style-type: none"> Check the wiring connection, Clean the coil condenser, Check the fan operating. 	[2423] [2433]
115	Circuit 1, Safety High Pressure, Cut-off. <i>The condensing pressure read by the pressure transducer exceeds the maximum limit.</i>	Threshold: > 42bar/64°C, Waiting stop: 30min, Enabled: 5s after one compressor start.	Stop C1 compressors.	3/day	<ul style="list-style-type: none"> Too much Refrigerant charge, Problem with wiring connection, pressure transducer Coil condenser dirty, Fan condenser not operating. 	<ul style="list-style-type: none"> Check the circuit operating, Check the wiring connection, Clean the coil condenser, Check the fan operating. 	[2414]
116	Circuit 1 Compressor, Delta Pressure (HP-LP), Too Low. <i>The Δp(High-Low) pressure is lower than the safety limit.</i>	Threshold: < 1bar, Delayed: 5s, Waiting stop: 1min, Enabled: 1min after one compressor start.	Stop C1 compressors.	3/day	<ul style="list-style-type: none"> Electric circuit breaker cut, Problem with wiring connection, Reversing valve locked 	<ul style="list-style-type: none"> Check the compressor, Check the wiring connection, Check the reversing valve swap 	[2412] and [2414]
117	Circuit 1, Safety Low Pressure, Cut-off. <i>The suction temperature calculated by the LP pressure sensor is lower than the permitted threshold.</i>	Threshold: < -27°C, Delayed: 2min, Waiting stop: 30min, Enabled: 6min after one compressor start. Or Threshold: < -33°C, Delayed: Immediately, Enabled: immediately.	Stop C1 compressors.	3/day or Manually	<ul style="list-style-type: none"> Refrigerant charge 	<ul style="list-style-type: none"> Check the circuit operating 	[2416]

CODE	DESCRIPTION	CONDITION	EFFECT	RESET	POSSIBLE CAUSES	POSSIBLE REMEDIES	DS MENU
118	Circuit 1, Water Evaporator, Risk of Frosting. <i>The suction temperature calculated by the LP pressure sensor is too low and may pose a risk for the water evaporator.</i>	Threshold: [3513] 0% Glycol < 0°C, Threshold: [3513] 50% Glycol < -20°C, Delayed: 5s, Waiting stop: 6min, Enabled: 2s after one compressor start in heating mode.	Stop C1 compressors.	6/day	<ul style="list-style-type: none"> • Limit indoor/outdoor temperature conditions, • Refrigerant charge, • Problem with the expansion valve. 	<ul style="list-style-type: none"> • Wait normal temperature conditions, • Check the circuit operating, • Replace the expansion valve. 	[2412]
119	Circuit 1 Compressor, Condensing T°, Too Low. <i>The temperature measured by the probe is outside of the permitted range.</i>	Threshold: < 21.5°C, Delayed: 6min, Waiting stop: 30min, Enabled: 3min after one compressor or condenser fan start/stop.	Stop C1 compressors.	Automatic	<ul style="list-style-type: none"> • Limit indoor/outdoor temperature conditions, • Refrigerant charge, • Problem with the expansion valve. 	<ul style="list-style-type: none"> • Wait normal temperature conditions, • Check the circuit operating, • Replace the expansion valve. 	[2414]
121	Circuit 1, Superheat T°, Too Low. <i>The value calculated is outside of the permitted range.</i>	Threshold: < [3621] - 3K, Delayed: 6min, Waiting stop: 6min, Enabled: 6min after one compressor start, then 3min after one compressor or condenser fan start/stop.	Stop C1 compressors.	3/day	<ul style="list-style-type: none"> • Limit indoor/outdoor temperature conditions, • Refrigerant charge, • Problem with the expansion valve. 	<ul style="list-style-type: none"> • Wait normal temperature conditions, • Check the circuit operating, • Replace the expansion valve. 	[2616]
122	Circuit 1, Superheat T°, Too High. <i>The value calculated is outside of the permitted range.</i>	Threshold: (LP < 5°C) < 15K, Threshold: (LP > 5°C) < 25K, Delayed: 6min, Waiting stop: 6min, Enabled: 6min after one compressor start, then 3min after one compressor or condenser fan start/stop.	Stop C1 compressors.	3/day	<ul style="list-style-type: none"> • Limit indoor/outdoor temperature conditions, • Refrigerant charge, • Problem with the expansion valve. 	<ul style="list-style-type: none"> • Wait normal temperature conditions, • Check the circuit operating, • Replace the expansion valve. 	[2616]
123	Circuit 1, Subcooling, Too Low. <i>The value calculated is outside of the permitted range.</i>	Threshold: < 0.6K, Delayed: 6min, Enabled: 3min after one compressor or condenser fan start/stop.	Signalling.	Automatic	<ul style="list-style-type: none"> • Limit indoor/outdoor temperature conditions, • Refrigerant charge, • Problem with the expansion valve. 	<ul style="list-style-type: none"> • Wait normal temperature conditions, • Check the circuit operating, • Replace the expansion valve. 	[2623]

CODE	DESCRIPTION	CONDITION	EFFECT	RESET	POSSIBLE CAUSES	POSSIBLE REMEDIES	DS MENU
124	Circuit 1, Subcooling, Too high. <i>The value calculated is outside of the permitted range.</i>	Threshold: > 16K, Delayed: 6min, Enabled: 3min after one compressor or condenser fan start/stop.	Signalling.	Automatic	<ul style="list-style-type: none"> • Limit indoor/outdoor temperature conditions, • Refrigerant charge, • Problem with the expansion valve. 	<ul style="list-style-type: none"> • Wait normal tempetaure conditions, • Check the circuit operating, • Replace the expansion valve. 	[2623]
127	Circuit 1 Compressor, MOP operating, (Max Operating Press.). <i>The suction temperature calculated by the LP pressure sensor is outside of the permitted range.</i>	Threshold: (HP < 20°C) < 5°C, Threshold: (HP > 45/30°C) < 26/15°C, Delayed: 6min, Enabled: 3min after one compressor or condenser fan start/stop.	Signalling.	Automatic	<ul style="list-style-type: none"> • Limit indoor/outdoor temperature conditions, • Refrigerant charge, • Problem with the expansion valve. 	<ul style="list-style-type: none"> • Wait normal tempetaure conditions, • Check the circuit operating, • Replace the expansion valve. 	[2412] and [2414]
128	Circuit 1 Compressor, LOP operating, (Low Operating Press.). <i>The suction temperature calculated by the LP pressure sensor is outside of the permitted range.</i>	Threshold: (HP < 35°C) < -25°C, Threshold: (HP < 55°C) < -5°C, Threshold: (HP > 65°C) < 12.5°C, Delayed: 1min, Enabled: 3min after one compressor or condenser fan start/stop.	Signalling.	Automatic	<ul style="list-style-type: none"> • Limit indoor/outdoor temperature conditions, • Refrigerant charge, • Problem with the expansion valve. 	<ul style="list-style-type: none"> • Wait normal tempetaure conditions, • Check the circuit operating, • Replace the expansion valve. 	[2412] and [2414]
129	Circuit 1 Compressor, Condensing T°, Too High. <i>The temperature measured by the probe is outside of the permitted range.</i>	Threshold: > 61°C, Delayed: 20s, Waiting stop: 6min, Enabled: 3min after one compressor or condenser fan start/stop.	Stop C1 compressors.	Automatic	<ul style="list-style-type: none"> • Limit indoor/outdoor temperature conditions, • Refrigerant charge, • Problem with the expansion valve. 	<ul style="list-style-type: none"> • Wait normal tempetaure conditions, • Check the circuit operating, • Replace the expansion valve. 	[2414]
130	Circuit 1 Compressor, Discharge T°, Too High. <i>Over-temperature detected on the 1st circuit discharge temperature.</i>	Threshold: > 140°C, Delayed: 20s, Waiting stop: 6min, Enabled: 5s after one compressor start.	Stop C1 compressors.	3/day	<ul style="list-style-type: none"> • Compressor failure 	<ul style="list-style-type: none"> • Check the compressor 	[2426] [2436]
132	Circuit 1, Elec. Expansion Valve, Motor. <i>The driver of EEV signals a failure on the system.</i>	Delayed: 1s.	Stop C1 compressors.	Automatic	<ul style="list-style-type: none"> • EEV failure 	<ul style="list-style-type: none"> • Check the EEV 	#
141	Circuit 1, High Pressure, Sensor. <i>The value of the sensor measured is incorrect.</i>	Delayed: 15s.	Stop C1 compressors.	Automatic	<ul style="list-style-type: none"> • Sensor failure, • Problem with wiring of sensor. 	<ul style="list-style-type: none"> • Check the sensor • Check the wiring connections. 	[2414]

CODE	DESCRIPTION	CONDITION	EFFECT	RESET	POSSIBLE CAUSES	POSSIBLE REMEDIES	DS MENU
142	Circuit 1, Low Pressure, Sensor. <i>The value of the sensor measured is incorrect.</i>	Delayed: 15s.	Stop C1 compressors.	Automatic	<ul style="list-style-type: none"> • Sensor failure, • Problem with wiring of sensor. 	<ul style="list-style-type: none"> • Check the sensor • Check the wiring connections. 	[2412]
143	Circuit 1, Liquid Temperature, Probe. <i>The value of the probe measured is incorrect.</i>	Delayed: 15s.	Stop C1 compressors.	Automatic	<ul style="list-style-type: none"> • Probe failure, • Problem with wiring of probe. 	<ul style="list-style-type: none"> • Check the probe • Check the wiring connections. 	[2415]
144	Circuit 1, Suction T°, Probe. <i>The value of the probe measured is incorrect.</i>	Delayed: 15s.	Stop C1 compressors.	Automatic	<ul style="list-style-type: none"> • Probe failure, • Problem with wiring of probe. 	<ul style="list-style-type: none"> • Check the probe • Check the wiring connections. 	[2614]
145	Circuit 1, Discharge T°, Probe. <i>The value of the probe measured is incorrect.</i>	Delayed: 15s.	Stop C1 compressors.	Automatic	<ul style="list-style-type: none"> • Probe failure, • Problem with wiring of probe. 	<ul style="list-style-type: none"> • Check the probe • Check the wiring connections. 	[2426]
148	Circuit 1, BLDC, High Discharge Temperature. <i>Over-temperature detected on the inverter circuit discharge temperature.</i>	Threshold: > 60°C, Waiting stop: 6min, Enabled: Compressor start.	Stop C1 compressors.	3/day	<ul style="list-style-type: none"> • Limit indoor/outdoor temperature conditions, • Refrigerant charge, • Problem with the expansion valve. 	<ul style="list-style-type: none"> • Wait normal tempetaure conditions, • Check the circuit operating, • Replace the expansion valve. 	[2426]
149	Circuit 1, BLDC, Low Pressure Difference. <i>The Δp(High-Low) pressure persists for a period of time under the limit value. Thus optimal lubrication is not guaranteed.</i>	Waiting stop: 6min, Enabled: Compressor start.	Stop C1 compressors.	3/day	<ul style="list-style-type: none"> • Limit indoor/outdoor temperature conditions, • Refrigerant charge, • Problem with the expansion valve. 	<ul style="list-style-type: none"> • Wait normal tempetaure conditions, • Check the circuit operating, • Replace the expansion valve. 	[2412]
150	Circuit 1, BLDC, Compressor Fails to Star. <i>A specific algorithm checks whether the compressor actually started and, if this is not the case, signals failed compressor start through an alarm.</i>	Waiting stop: 6min, Enabled: Compressor start.	Stop C1 compressors.	3/day	<ul style="list-style-type: none"> • Limit indoor/outdoor temperature conditions, • Refrigerant charge, • Problem with the expansion valve. 	<ul style="list-style-type: none"> • Wait normal tempetaure conditions, • Check the circuit operating, • Replace the expansion valve. 	#
151	Circuit 1, BLDC, Out of Envelop. <i>The suction temperature calculated by the LP pressure sensor is outside of the permitted range.</i>	Waiting stop: 6min, Enabled: Compressor start.	Stop C1 compressors.	3/day	<ul style="list-style-type: none"> • Limit indoor/outdoor temperature conditions, • Refrigerant charge, • Problem with the expansion valve. 	<ul style="list-style-type: none"> • Wait normal tempetaure conditions, • Check the circuit operating, • Replace the expansion valve. 	[2412] and [2414]

CODE	DESCRIPTION	CONDITION	EFFECT	RESET	POSSIBLE CAUSES	POSSIBLE REMEDIES	DS MENU
152	Circuit 1, BLDC, Power+. <i>The status of the inverter signals a failure on the system.</i>	Waiting stop: 6min, Enabled: Compressor start.	Stop C1 compressors.	3/day	<ul style="list-style-type: none"> • Driver failed, • Problem with wiring of fieldbus. 	<ul style="list-style-type: none"> • Replace driver, • Check the bus connections 	#
201	EVD N°2, Link Failure. <i>The driver 2 of EEV is disconnected from the Fieldbus network.</i>	Delayed: 30s, Enabled: 1min after power on.	Stop C1 and/or C2 compressors.	Automatic	<ul style="list-style-type: none"> • Driver failed, • Problem with wiring of fieldbus. 	<ul style="list-style-type: none"> • Replace driver, • Check the bus connections 	#
202	Circuit 2, Fan Condenser. <i>The thermal motor protection of the condenser fan has detected an over temperature.</i>	Delayed: 5s, Waiting stop: 30min, Enabled: 5s after fan start.	Stop C2 compressors.	3/day	<ul style="list-style-type: none"> • Electric circuit breaker cut, • Fan motor damaged, • Thermal motor protection devices activated, • Problem with wiring connection. 	<ul style="list-style-type: none"> • Check, Replace the fan motor, • Check the connection. 	[2215]
203	Circuit 2, Fan Condenser Inverter. <i>Alarm reading by bus on fans inverter.</i>	Delayed: 15s.	Stop C1 compressors.	Automatic	<ul style="list-style-type: none"> • Fan motor damaged, • Thermal motor protection devices activated. 	<ul style="list-style-type: none"> • Check fans motor. 	#
210	Circuit 2, Leak Refrigerant, Detected. <i>The CLIMATIC has detected a risk of leakage of the refrigerant circuit.</i>	...	Signalling.	Manually	<ul style="list-style-type: none"> • Refrigerant leakage 	<ul style="list-style-type: none"> • Check the circuit operating 	#
214	Circuit 2, Compressor, Electrical Failure. <i>An electrical failure happened in the compressors of the circuit.</i>	Waiting stop: 30min, Enabled: 5s after one compressor start.	Stop C2 compressors.	3/day	<ul style="list-style-type: none"> • Problem with wiring connection, pressure switch or compressor internal safety switch • Coil condenser dirty, • Fan condenser not operating. 	<ul style="list-style-type: none"> • Check the wiring connection, • Clean the coil condenser, • Check the fan operating. 	[2453] [2463]
215	Circuit 2, Safety High Pressure, Cut-off. <i>The condensing pressure read by the pressure transducer exceeds the maximum limit.</i>	Threshold: > 42bar/64°C, Waiting stop: 30min, Enabled: 5s after one compressor start.	Stop C2 compressors.	3/day	<ul style="list-style-type: none"> • Too much Refrigerant charge, • Problem with wiring connection, pressure transducer • Coil condenser dirty, • Fan condenser not operating. 	<ul style="list-style-type: none"> • Check the circuit operating, • Check the wiring connection, • Clean the coil condenser, • Check the fan operating. 	[2444]
216	Circuit 2 Compressor, Delta Pressure (HP-LP), Too Low. <i>The Δp(High-Low) pressure is lower than the safety limit.</i>	Threshold: < 1bar, Delayed: 5s, Waiting stop: 1min, Enabled: 1min after one compressor start.	Stop C2 compressors.	3/day	<ul style="list-style-type: none"> • Electric circuit breaker cut, • Problem with wiring connection, • Reversing valve locked 	<ul style="list-style-type: none"> • Check the compressor, • Check the wiring connection, • Check the reversing valve swap 	[2442] and [2444]

CODE	DESCRIPTION	CONDITION	EFFECT	RESET	POSSIBLE CAUSES	POSSIBLE REMEDIES	DS MENU
217	<p>Circuit 2, Safety Low Pressure, Cut-off. The suction temperature calculated by the LP pressure sensor is lower than the permitted threshold.</p>	<p>Threshold: < -27°C, Delayed: 2min, Waiting stop: 30min, Enabled: 6min after one compressor start. Or Threshold: < -33°C, Delayed: Immediately, Enabled: immediately.</p>	Stop C2 compressors.	3/day or Manually	<ul style="list-style-type: none"> • Refrigerant charge 	<ul style="list-style-type: none"> • Check the circuit operating 	[2446]
218	<p>Circuit 2, Water Evaporator, Risk of Frosting. The suction temperature calculated by the LP pressure sensor is too low and may pose a risk for the water evaporator.</p>	<p>Threshold: [3513] 0% Glycol < 0°C, Threshold: [3513] 50% Glycol < -20°C, Delayed: 5s, Waiting stop: 6min, Enabled: 2s after one compressor start in heating mode.</p>	Stop C2 compressors.	6/day	<ul style="list-style-type: none"> • Limit indoor/outdoor temperature conditions, • Refrigerant charge, • Problem with the expansion valve. 	<ul style="list-style-type: none"> • Wait normal temperature conditions, • Check the circuit operating, • Replace the expansion valve. 	[2442]
219	<p>Circuit 2 Compressor, Condensing T°, Too Low. The temperature measured by the probe is outside of the permitted range.</p>	<p>Threshold: < 21.5°C, Delayed: 6min, Waiting stop: 30min, Enabled: 3min after one compressor or condenser fan start/stop.</p>	Signalling.	Automatic	<ul style="list-style-type: none"> • Limit indoor/outdoor temperature conditions, • Refrigerant charge, • Problem with the expansion valve. 	<ul style="list-style-type: none"> • Wait normal temperature conditions, • Check the circuit operating, • Replace the expansion valve. 	#
221	<p>Circuit 2, Superheat T°, Too Low. The value calculated is outside of the permitted range.</p>	<p>Threshold: < [3621] - 3K, Delayed: 6min, Waiting stop: 6min, Enabled: 6min after one compressor start, then 3min after one compressor or condenser fan start/stop.</p>	Stop C2 compressors.	3/day	<ul style="list-style-type: none"> • Limit indoor/outdoor temperature conditions, • Refrigerant charge, • Problem with the expansion valve. 	<ul style="list-style-type: none"> • Wait normal temperature conditions, • Check the circuit operating, • Replace the expansion valve. 	[2636]

CODE	DESCRIPTION	CONDITION	EFFECT	RESET	POSSIBLE CAUSES	POSSIBLE REMEDIES	DS MENU
222	Circuit 2, Superheat T°, Too High. <i>The value calculated is outside of the permitted range.</i>	Threshold: (LP < 5°C) < 15K, Threshold: (LP > 5°C) < 25K, Delayed: 6min, Waiting stop: 6min, Enabled: 6min after one compressor start, then 3min after one compressor or condenser fan start/stop.	Stop C2 compressors.	3/day	<ul style="list-style-type: none"> • Limit indoor/outdoor temperature conditions, • Refrigerant charge, • Problem with the expansion valve. 	<ul style="list-style-type: none"> • Wait normal tempetaure conditions, • Check the circuit operating, • Replace the expansion valve. 	[2636]
223	Circuit 2, Subcooling, Too Low. <i>The value calculated is outside of the permitted range.</i>	Threshold: < 0.6K, Delayed: 6min, Enabled: 3min after one compressor or condenser fan start/stop.	Signalling.	Automatic	<ul style="list-style-type: none"> • Limit indoor/outdoor temperature conditions, • Refrigerant charge, • Problem with the expansion valve. 	<ul style="list-style-type: none"> • Wait normal tempetaure conditions, • Check the circuit operating, • Replace the expansion valve. 	[2643]
224	Circuit 2, Subcooling, Too high. <i>The value calculated is outside of the permitted range.</i>	Threshold: > 16K, Delayed: 6min, Enabled: 3min after one compressor or condenser fan start/stop.	Signalling.	Automatic	<ul style="list-style-type: none"> • Limit indoor/outdoor temperature conditions, • Refrigerant charge, • Problem with the expansion valve. 	<ul style="list-style-type: none"> • Wait normal tempetaure conditions, • Check the circuit operating, • Replace the expansion valve. 	[2643]
227	Circuit 2 Compressor, MOP operating, (Max Operating Press.). <i>The suction temperature calculated by the LP pressure sensor is outside of the permitted range.</i>	Threshold: (HP < 20°C) < 5°C, Threshold: (HP > 45/30°C) < 26/15°C, Delayed: 6min, Enabled: 3min after one compressor or condenser fan start/stop.	Signalling.	Automatic	<ul style="list-style-type: none"> • Limit indoor/outdoor temperature conditions, • Refrigerant charge, • Problem with the expansion valve. 	<ul style="list-style-type: none"> • Wait normal tempetaure conditions, • Check the circuit operating, • Replace the expansion valve. 	[2442] and [2444]
228	Circuit 2 Compressor, LOP operating, (Low Operating Press.). <i>The suction temperature calculated by the LP pressure sensor is outside of the permitted range.</i>	Threshold: (HP < 35°C) < -25°C, Threshold: (HP < 55°C) < -5°C, Threshold: (HP > 65°C) < 12.5°C, Delayed: 1min, Enabled: 3min after one compressor or condenser fan start/stop.	Signalling.	Automatic	<ul style="list-style-type: none"> • Limit indoor/outdoor temperature conditions, • Refrigerant charge, • Problem with the expansion valve. 	<ul style="list-style-type: none"> • Wait normal tempetaure conditions, • Check the circuit operating, • Replace the expansion valve. 	[2442] and [2444]

CODE	DESCRIPTION	CONDITION	EFFECT	RESET	POSSIBLE CAUSES	POSSIBLE REMEDIES	DS MENU
229	Circuit 2 Compressor, Condensing T°, Too High. <i>The temperature measured by the probe is outside of the permitted range.</i>	Threshold: > 61°C, Delayed: 20s, Waiting stop: 6min, Enabled: 3min after one compressor or condenser fan start/stop.	Signalling.	Automatic	<ul style="list-style-type: none"> Limit indoor/outdoor temperature conditions, Refrigerant charge, Problem with the expansion valve. 	<ul style="list-style-type: none"> Wait normal tempetaure conditions, Check the circuit operating, Replace the expansion valve. 	[2444]
230	Circuit 2 Compressor, Discharge T°, Too High. <i>Over-temperature detected on the 2nd circuit discharge temperature.</i>	Threshold: > 140°C, Delayed: 20s, Waiting stop: 6min, Enabled: 5s after one compressor start.	Stop C2 compressors.	3/day	<ul style="list-style-type: none"> Compressor failure 	<ul style="list-style-type: none"> Check the compressor 	[2426] [2436]
232	Circuit 2, Elec. Expansion Valve, Motor. <i>The driver of EEV signals a failure on the system.</i>	Delayed: 1s.	Stop C2 compressors.	Automatic	<ul style="list-style-type: none"> EEV failure 	<ul style="list-style-type: none"> Check the EEV 	#
241	Circuit 2, High Pressure, Sensor. <i>The value of the sensor measured is incorrect.</i>	Delayed: 15s.	Stop C2 compressors.	Automatic	<ul style="list-style-type: none"> Sensor failure, Problem with wiring of sensor. 	<ul style="list-style-type: none"> Check the sensor Check the wiring connections. 	[2444]
242	Circuit 2, Low Pressure, Sensor. <i>The value of the sensor measured is incorrect.</i>	Delayed: 15s.	Stop C2 compressors.	Automatic	<ul style="list-style-type: none"> Sensor failure, Problem with wiring of sensor. 	<ul style="list-style-type: none"> Check the sensor Check the wiring connections. 	[2442]
243	Circuit 2, Liquid Temperature, Probe. <i>The value of the sensor measured is incorrect.</i>	Delayed: 15s.	Stop C1 compressors.	Automatic	<ul style="list-style-type: none"> Probe failure, Problem with wiring of probe. 	<ul style="list-style-type: none"> Check the probe Check the wiring connections. 	[2445]
244	Circuit 2, Suction T°, Probe. <i>The value of the sensor measured is incorrect.</i>	Delayed: 15s.	Stop C1 compressors.	Automatic	<ul style="list-style-type: none"> Probe failure, Problem with wiring of probe. 	<ul style="list-style-type: none"> Check the probe Check the wiring connections. 	[2614]
301	EVD N°3, Link Failure. <i>The driver 3 of EEV is disconnected from the Fieldbus network.</i>	Delayed: 30s, Enabled: 1min after power on.	Stop C1 and/or C2 compressors.	Automatic	<ul style="list-style-type: none"> Driver failed, Problem with wiring of fieldbus. 	<ul style="list-style-type: none"> Replace driver, Check the bus connections 	#
310	Circuit 3, Leak Refrigerant, Detected. <i>The CLIMATIC has detected a risk of leakage of the refrigerant circuit.</i>	...	Signalling.	Manually	<ul style="list-style-type: none"> Refrigerant leakage 	<ul style="list-style-type: none"> Check the circuit operating 	#

CODE	DESCRIPTION	CONDITION	EFFECT	RESET	POSSIBLE CAUSES	POSSIBLE REMEDIES	DS MENU
314	Circuit 3, Compressor, Electrical Failure. <i>An electrical failure happened in the compressors of the circuit.</i>	Waiting stop: 30min, Enabled: 5s after one compressor start.	Stop C3 compressors.	3/day	<ul style="list-style-type: none"> • Problem with wiring connection, pressure switch or compressor internal safety switch • Coil condenser dirty, • Fan condenser not operating. 	<ul style="list-style-type: none"> • Check the wiring connection, • Clean the coil condenser, • Check the fan operating. 	#
315	Circuit 3, Safety High Pressure, Cut-off. <i>The condensing pressure read by the pressure transducer exceeds the maximum limit.</i>	Threshold: > 42bar/64°C, Waiting stop: 30min, Enabled: 5s after one compressor start.	Stop C3 compressors.	3/day	<ul style="list-style-type: none"> • Too much Refrigerant charge, • Problem with wiring connection, pressure transducer • Coil condenser dirty, • Fan condenser not operating. 	<ul style="list-style-type: none"> • Check the circuit operating, • Check the wiring connection, • Clean the coil condenser, • Check the fan operating. 	#
316	Circuit 3 Compressor, Delta Pressure (HP-LP), Too Low. <i>The Δp(High-Low) pressure is lower than the safety limit.</i>	Threshold: < 1bar, Delayed: 5s, Waiting stop: 1min, Enabled: 1min after one compressor start.	Stop C3 compressors.	3/day	<ul style="list-style-type: none"> • Electric circuit breaker cut, • Problem with wiring connection, • Reversing valve locked 	<ul style="list-style-type: none"> • Check the compressor, • Check the wiring connection, • Check the reversing valve swap 	#
317	Circuit 3, Safety Low Pressure, Cut-off. <i>The suction temperature calculated by the LP pressure sensor is lower than the permitted threshold.</i>	Threshold: < -27°C, Delayed: 2min, Waiting stop: 30min, Enabled: 6min after one compressor start. Or Threshold: < -33°C, Delayed: Immediately, Enabled: immediately.	Stop C3 compressors.	3/day or Manually	<ul style="list-style-type: none"> • Refrigerant charge 	<ul style="list-style-type: none"> • Check the circuit operating 	#
319	Circuit 3 Compressor, Condensing T°, Too Low. <i>The temperature measured by the probe is outside of the permitted range.</i>	Threshold: < 21.5°C, Delayed: 6min, Waiting stop: 30min, Enabled: 3min after one compressor or condenser fan start/stop.	Signalling.	Automatic	<ul style="list-style-type: none"> • Limit indoor/outdoor temperature conditions, • Refrigerant charge, • Problem with the expansion valve. 	<ul style="list-style-type: none"> • Wait normal tempetaure conditions, • Check the circuit operating, • Replace the expansion valve. 	#

CODE	DESCRIPTION	CONDITION	EFFECT	RESET	POSSIBLE CAUSES	POSSIBLE REMEDIES	DS MENU
321	Circuit 3, Superheat T°, Too Low. <i>The value calculated is outside of the permitted range.</i>	Threshold: < 2K, Delayed: 6min, Waiting stop: 6min, Enabled: 6min after one compressor start, then 3min after one compressor or condenser fan start/stop.	Stop C3 compressors.	3/day	<ul style="list-style-type: none"> • Limit indoor/outdoor temperature conditions, • Refrigerant charge, • Problem with the expansion valve. 	<ul style="list-style-type: none"> • Wait normal tempetaure conditions, • Check the circuit operating, • Replace the expansion valve. 	#
322	Circuit 3, Superheat T°, Too High. <i>The value calculated is outside of the permitted range.</i>	Threshold: (LP < 5°C) < 15K, Threshold: (LP > 5°C) < 25K, Delayed: 6min, Waiting stop: 6min, Enabled: 6min after one compressor start, then 3min after one compressor or condenser fan start/stop.	Stop C3 compressors.	3/day	<ul style="list-style-type: none"> • Limit indoor/outdoor temperature conditions, • Refrigerant charge, • Problem with the expansion valve. 	<ul style="list-style-type: none"> • Wait normal tempetaure conditions, • Check the circuit operating, • Replace the expansion valve. 	#
323	Circuit 3, Subcooling, Too Low. <i>The value calculated is outside of the permitted range.</i>	Threshold: < 0.6K, Delayed: 6min, Enabled: 3min after one compressor or condenser fan start/stop.	Signalling.	Automatic	<ul style="list-style-type: none"> • Limit indoor/outdoor temperature conditions, • Refrigerant charge, • Problem with the expansion valve. 	<ul style="list-style-type: none"> • Wait normal tempetaure conditions, • Check the circuit operating, • Replace the expansion valve. 	#
324	Circuit 3, Subcooling, Too high. <i>The value calculated is outside of the permitted range.</i>	Threshold: > 16K, Delayed: 6min, Enabled: 3min after one compressor or condenser fan start/stop.	Signalling.	Automatic	<ul style="list-style-type: none"> • Limit indoor/outdoor temperature conditions, • Refrigerant charge, • Problem with the expansion valve. 	<ul style="list-style-type: none"> • Wait normal tempetaure conditions, • Check the circuit operating, • Replace the expansion valve. 	#
327	Circuit 3 Compressor, MOP operating, (Max Operating Press.). <i>The suction temperature calculated by the LP pressure sensor is outside of the permitted range.</i>	Threshold: (HP < 20°C) < 5°C, Threshold: (HP > 45/30°C) < 26/15°C, Delayed: 6min, Enabled: 3min after one compressor or condenser fan start/stop.	Signalling.	Automatic	<ul style="list-style-type: none"> • Limit indoor/outdoor temperature conditions, • Refrigerant charge, • Problem with the expansion valve. 	<ul style="list-style-type: none"> • Wait normal tempetaure conditions, • Check the circuit operating, • Replace the expansion valve. 	#

CODE	DESCRIPTION	CONDITION	EFFECT	RESET	POSSIBLE CAUSES	POSSIBLE REMEDIES	DS MENU
328	Circuit 3 Compressor, LOP operating, (Low Operating Press.). The suction temperature calculated by the LP pressure sensor is outside of the permitted range.	Threshold: (HP < 35°C) < -25°C, Threshold: (HP < 55°C) < -5°C, Threshold: (HP > 65°C) < 12.5°C, Delayed: 1min, Enabled: 3min after one compressor or condenser fan start/stop.	Signalling.	Automatic	<ul style="list-style-type: none"> • Limit indoor/outdoor temperature conditions, • Refrigerant charge, • Problem with the expansion valve. 	<ul style="list-style-type: none"> • Wait normal tempetaure conditions, • Check the circuit operating, • Replace the expansion valve. 	#
329	Circuit 3 Compressor, Condensing T°, Too High. The temperature measured by the probe is outside of the permitted range.	Threshold: > 61°C, Delayed: 20s, Waiting stop: 6min, Enabled: 3min after one compressor or condenser fan start/stop.	Signalling.	Automatic	<ul style="list-style-type: none"> • Limit indoor/outdoor temperature conditions, • Refrigerant charge, • Problem with the expansion valve. 	<ul style="list-style-type: none"> • Wait normal tempetaure conditions, • Check the circuit operating, • Replace the expansion valve. 	#
341	Circuit 3, High Pressure, Faulty Sensor. The value of the sensor measured is incorrect.	Delayed: 15s.	Stop C3 compressors.	Automatic	<ul style="list-style-type: none"> • Sensor failure, • Problem with wiring of sensor. 	<ul style="list-style-type: none"> • Check the sensor • Check the wiring connections. 	#
342	Circuit 3, Low Pressure, Faulty Sensor. The value of the sensor measured is incorrect.	Delayed: 15s.	Stop C3 compressors.	Automatic	<ul style="list-style-type: none"> • Sensor failure, • Problem with wiring of sensor. 	<ul style="list-style-type: none"> • Check the sensor • Check the wiring connections. 	#
343	Circuit 3, Liquid Temperature, Probe. The value of the sensor measured is incorrect.	Delayed: 15s.	Stop C3 compressors.	Automatic	<ul style="list-style-type: none"> • Probe failure, • Problem with wiring of probe. 	<ul style="list-style-type: none"> • Check the probe • Check the wiring connections. 	#
344	Circuit 3, Suction T°, Probe. The value of the sensor measured is incorrect.	Delayed: 15s.	Stop C3 compressors.	Automatic	<ul style="list-style-type: none"> • Probe failure, • Problem with wiring of probe. 	<ul style="list-style-type: none"> • Check the probe • Check the wiring connections. 	#

SALES OFFICES :

BELGIUM AND LUXEMBOURG

+32 3 633 3045

FRANCE

+33 1 64 76 23 23

GERMANY

+49 (0) 211 950 79 60

ITALY

+39 02 495 26 200

NETHERLANDS

+31 332 471 800

POLAND

+48 22 58 48 610

PORTUGAL

+351 229 066 050

SPAIN

+34 915 401 810

UKRAINE

+38 044 585 59 10

UNITED KINGDOM AND IRELAND

+44 1604 669 100

OTHER COUNTRIES :

LENNOX DISTRIBUTION

+33 4 72 23 20 20

Due to LENNOX EMEA ongoing commitment to quality, the specifications, ratings and dimensions are subject to change without notice and without incurring liability. Improper installation, adjustment, alteration, service or maintenance can cause property damage or personal injury. Installation and service must be performed by a qualified installer and servicing agency.

