

0 5 10 15 20 25 30 35 40 45 50 55 60 65 70 75 80 85 90 95

INDICE	
REGLETERO CONEXIONES ELECTRICAS TERMINAL STRIP BORNIER DE CONNEXION ELECTRIQUE KLEMMLEISTE	HOJA 1/6
CIRCUITO POTENCIA POWER CIRCUIT CIRCUIT DE PUISSANCE STROMKREIS	HOJA 2/6
CIRCUITO MANIOBRA CONTROL CIRCUIT CIRCUIT DE CONTROL STUEERKREIS	HOJA 3/6
CONEXION OPCIONALES OPTIONS CONNEXIONS OPTIONNELS OPTIONEN / ZUBEHÖR	HOJA 4-5/6
LEYENDA REFERENCIAS REFERENCES LEGEND REFERENCE DE LEGENDE LEGENDE	HOJA 6/6



ESQUEMA ELECTRICICO  
WIRING DIAGRAM  
SCHEMA ELECTRIQUE  
SCHALTPLAN

Elemento Opcional  
Optional Element  
Element optionnel  
Optionales bauteil

-----

A realizar por el instalador  
To wire by the installer  
A câbler par l'installateur  
Verdrahtung durch den Installateur

-----

<b>%</b>	Lemnox Refrac S.A.	ESQUEMA ELECTRICICO ELECTRIC DIAGRAM	<b>ANHM 26E-32E-38E-43E</b> (LEHM+KNHM)	4Z-33-411-417 08M 3N ~ 400V 50Hz + PE
----------	--------------------	---	--	--

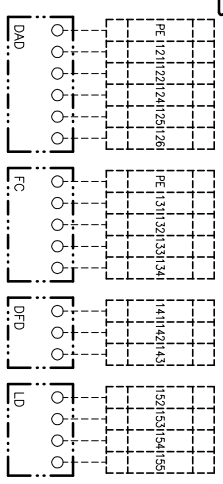

0 5 10 15 20 25 30 35 40 45 50 55 60 65 70 75 80 85 90 95

**⚠** RETIRAR PUENTE SI SE MONTA ON/OFF REMOTO  
 REMOVE LINK FOR REMOTE ON/OFF OPERATION  
**⚠** RETIRER LE PONT EN CAS DE MARCHÉ/ARRÊT A DISTANCE  
 ENFERNE DIE VERBINDUNG ZUM EIN/AUS FERNSCHALTER

ESTAS BORNAS SOLAMENTE SE INCLUYEN CON SU OPCIONAL  
 THESE TERMINALS ARE ONLY INCLUDED WITH ITS OPTIONAL  
 CES CONTACTS SONT INSTALLEES SEULEMENT SI ON DEMANDE CHOISIT L'OPTIONAL  
 DESE ANSCHLUSSKLEMMEN SIND NUR MIT ZUBEHÖR VERFÜGBAR IHREM OPTIONAL

VER MANUAL INSTALACION  
 SEE INSTALLATION MANUAL (IOM)  
 VOIR LE MANUEL D'INSTALLATION  
 SIEHE INSTALLATIONSHANDBUCH (IOM)

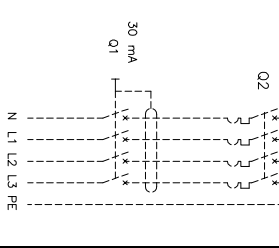
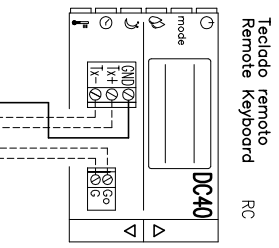
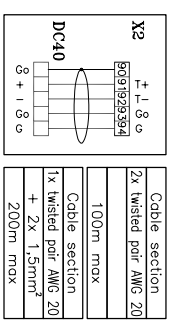
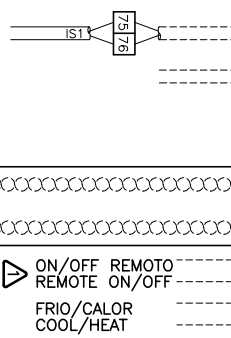
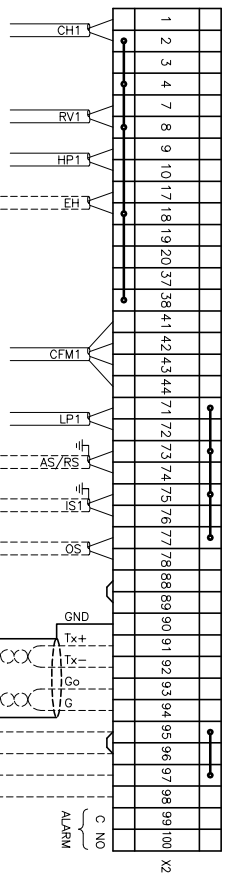

**⚠** CABLE APANTALLADO  
 SCREEN WIRE

Elemento Opcional  
 Optional Element  
 Element optionnel  
 Optionales bauteil

A realizar por el instalador  
 To wire by the installer  
 A câbler par l'installateur  
 Verdrahtung durch den installateur

**1/6**  
 Lemnox Refrac S.A.

ESQUEMA ELECTRICO  
 ELECTRIC DIAGRAM

**ANHM 26E-32E-38E-43E**  
**(LEHM+KNHM)**

ALIMENTACION  
 POWER SUPPLY  
 ELECTRIQUE  
 STROMZULEITUNG  
 3N~400V 50Hz+PE  
 4Z-3S-4T1-4T7 08M  
 3N ~ 400V 50Hz + PE

0 5 10 15 20 25 30 35 40 45 50 55 60 65 70 75 80 85 90 95

3N~400V 50Hz+PE  
 N L1 L2 L3 PE  
 VER MANUAL INSTALACION  
 SEE INSTALLATION MANUAL (OM)  
 VOIR LE MANUEL D'INSTALLATION  
 SIEHE INSTALLATIONSHANDBUCH (OM)

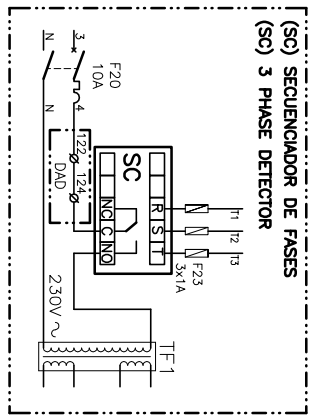
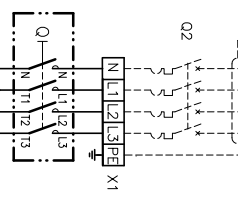

7,5kW	Im(CC)	10,8A
1S	Id(LRA)	16A
11kW	Im(CC)	15,9A
1S	Id(LRA)	20A
15kW	Im(CC)	21,7A
1S	Id(LRA)	25A

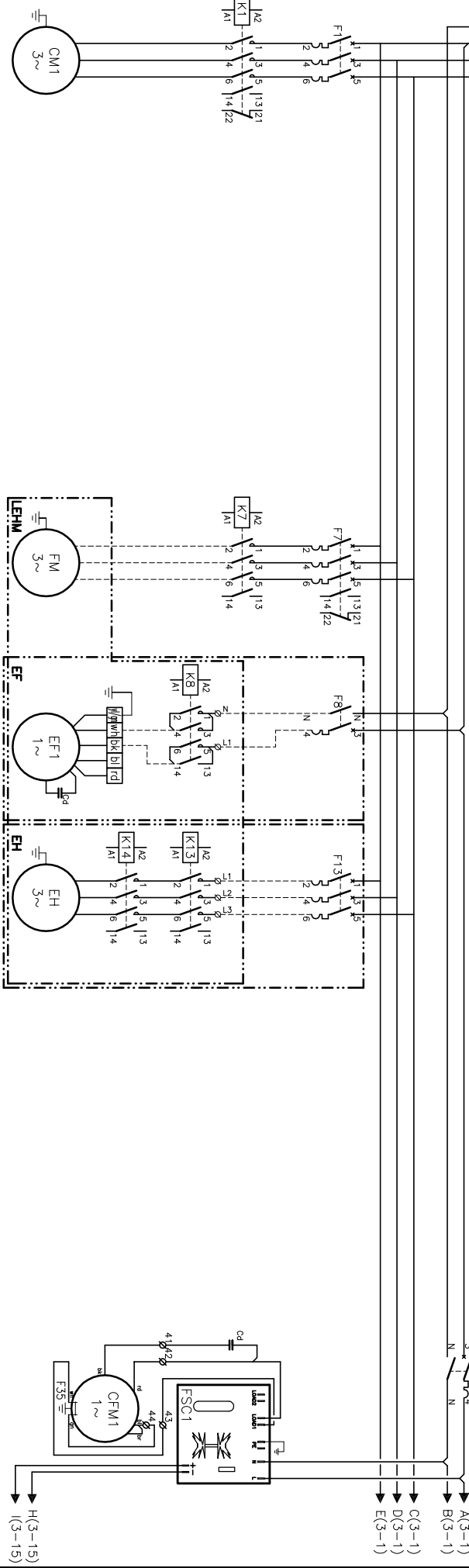

- CIRCUITO MANIOBRA
- CONTROL CIRCUIT
- CIRCUIT DE CONTROL
- STEUERKREIS

ANHM	Im(CC)	2,59A	3,45A	2,6A	3A
26E	Id(LRA)	1,73A	1,73A	1,73A	1,2A
32E	F	2,5-4A	2,5-4A	2,6A	3,4A
38E	F	2,59A	3,45A	2,6A	1,32A
43E	F	1,3A	1,73A	1,73A	1,32A
ANHM	Im(CC)	2,5-4A	2,5-4A	2,6A	3,4A
ANHM	Id(LRA)	1,3A	1,73A	1,73A	1,32A
ANHM	Im(CC)	3,45A	4,8A	6,8A	10A
ANHM	Id(LRA)	1,73A	2,64A	4,8A	3,4A
ANHM	Im(CC)	2,5-4A	4,8A	6,8A	3,4A
ANHM	Id(LRA)	1,74A	2,64A	4,6,3A	1,32A
ANHM	Im(CC)	4,6,3A	4,6,3A	2,6A	3A
ANHM	Id(LRA)	1,11A	1,3A	1,3A	1,2A
ANHM	F	2,5A	2,5-4A	2,6A	3,4A
ANHM	Im(CC)	2,59A	3,45A	2,6A	1,32A
ANHM	Id(LRA)	1,19A	1,3A	1,73A	1,32A
ANHM	F	2,5A	2,5-4A	2,6A	3,4A
ANHM	Im(CC)	2,59A	3,45A	2,6A	1,32A
ANHM	Id(LRA)	1,58A	1,73A	1,73A	1,32A
ANHM	F	3,2A	4,8A	6,8A	10A
ANHM	Im(CC)	3,1A	4,8A	6,8A	3,4A
ANHM	Id(LRA)	1,74A	2,64A	4,6,3A	1,32A
ANHM	F	3,2A	4,6,3A	2,6A	3A

Elemento Opcional  
 Optional Element  
 Element optionnel  
 Opcionales bauteil

A realizar por el instalador  
 To wire by the installer  
 A cobler par l'installateur  
 Verdringung durch den installateur

2/6 Lomox Refac S.A. ESQUEMA ELECTRICO (LEHM+KNHM) ANHM 26E-32E-38E-43E 4Z-33-411-417 08M 3N ~ 400V 50Hz + PE

0 5 10 15 20 25 30 35 40 45 50 55 60 65 70 75 80 85 90 95

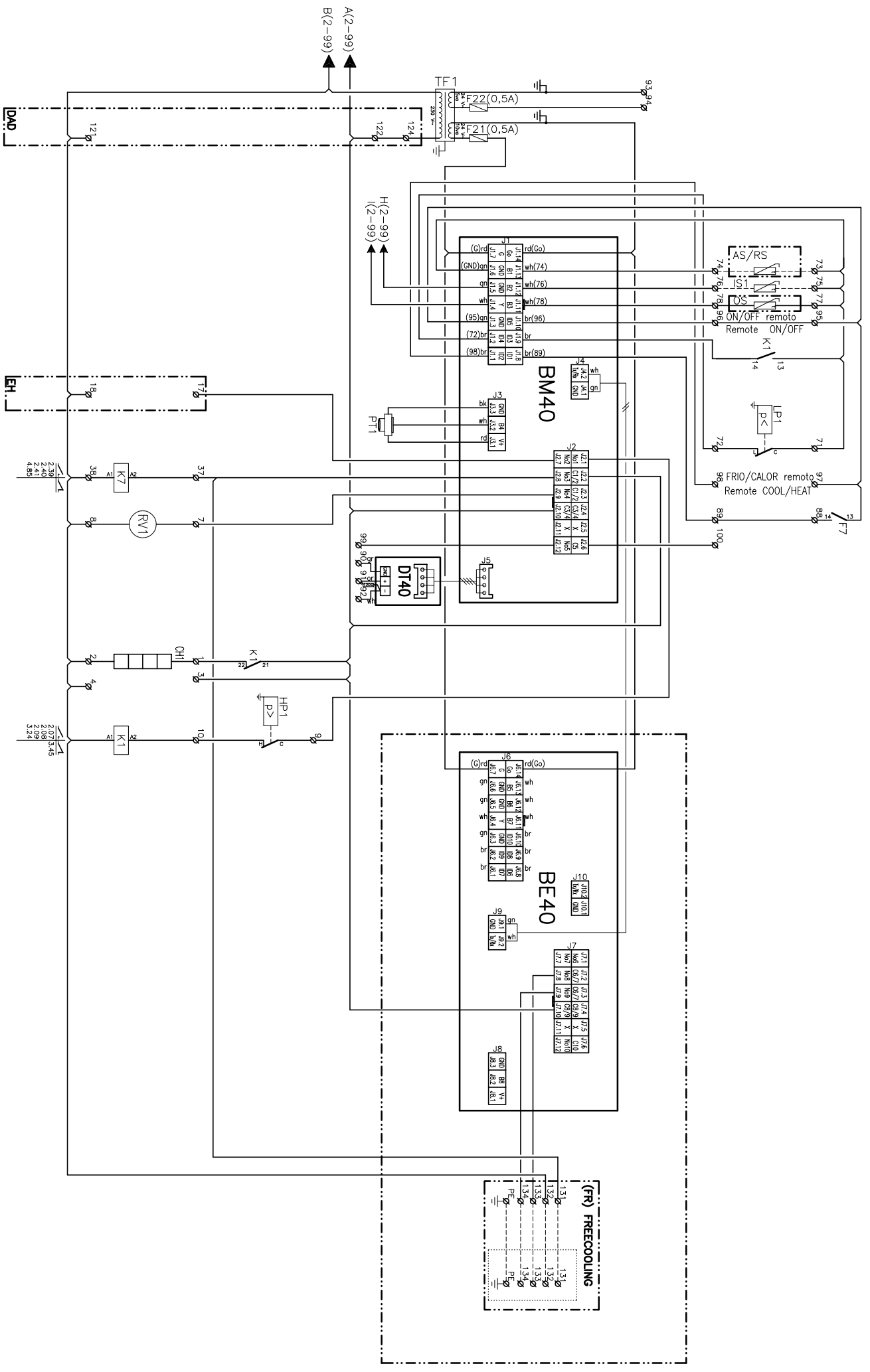

Elemento Opcional  
 Optional Element  
 Element optionel  
 Opcionales bauteil

A realizar por el instalador  
 To wire by the installer  
 A cobrir por l'instalador  
 Verdrahtung durch den Installateur

3/6  
 Lemnox Refrac S.A.

ESQUEMA ELECTRICO  
 ELECTRIC DIAGRAM

ANHM 26E-32E-38E-43E  
 (LEHM+KNHM)

4Z-33-411-417 08M  
 3N ~ 400V 50Hz + PE

**(SFS) SOFT STARTED**

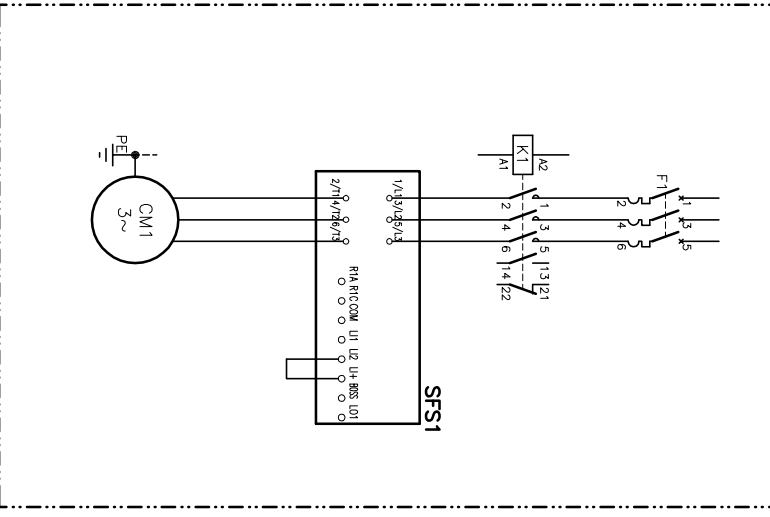

**(FR) FREECOOLING**

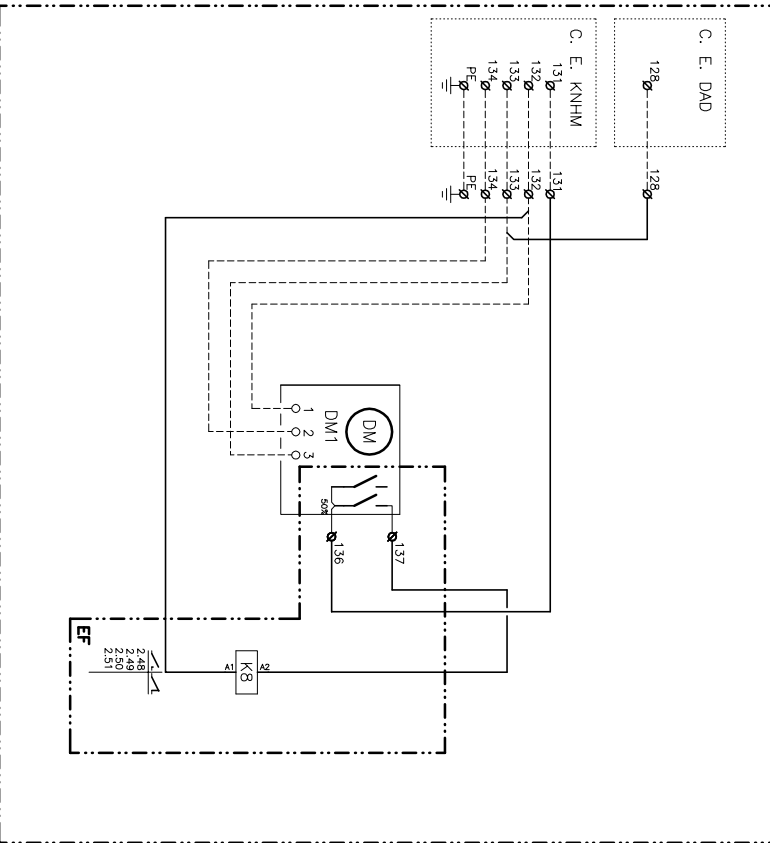

**(EH) BATERIA ELECTRICA / ELECTRICAL HEATER**

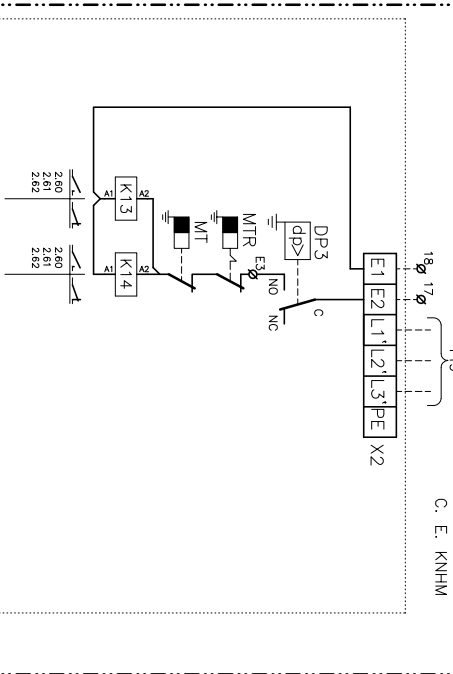

**(LD) KIT LARGA DISTANCIA / LONG DISTANCE KIT**

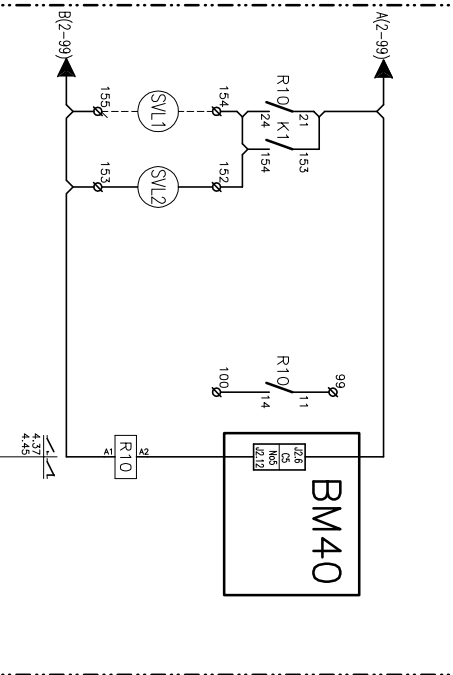

**(DFD) DETECTOR FILTRO SUCIO (DFD) DIRTY FILTER DETECTOR**

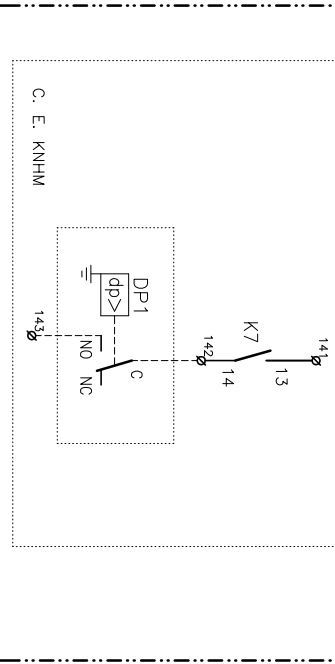

**(HWC) BATERIA AGUA CALIENTE (HWC) HOT WATER COIL**

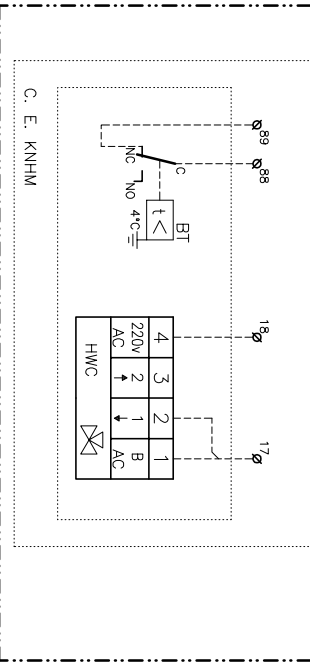

Elemento Opcional  
Optional Element  
Element optionnel  
Optionales bauteil

A realizar por el instalador  
To wire by the installer  
A cobler par l'installateur  
Verdrahtung durch den installateur

4/6  
Lennox Refrac S.A.

ESQUEMA ELECTRICO  
ELECTRIC DIAGRAM

ANHM 26E-32E-38E-43E  
(LEHM+KNHM)

4Z-33-411-417 08M  
3N ~ 400V 50Hz + PE

0 5 10 15 20 25 30 35 40 45 50 55 60 65 70 75 80 85 90 95

**(DAD) CONTROL DETECCIÓN DE HUMOS**  
**(DAD) SMOKE DETECTION CONTROL**

UNIDAD INTERIOR / INDOOR UNIT  
 UNITE INTERIEUR / INNENGERÄT

CUADRO PRINCIPAL/MAIN ELECTRICAL BOARD  
 COFFRET ELECTRIQUE/HAUPTPLATINE

RETIRAR PUENTE SI SE MONTA DAD  
 REMOVE LINK FOR DAD OPERATION  
 RETIRER LE POND S'IL Y A DAD  
 ENTFERNE DIE VERBINDUNG ZUM DAD

PARO UNIDAD  
 SHUT-DOWN UNIT  
 ARRÊT UNITE  
 GERÄT ABSCHALTEN

SEÑAL DE ALARMA  
 ALARM SIGNAL  
 SIGNALISATION D'ALARME  
 ALARMELDUNG

C. E. FREECOOLING/E.B. FREECOOLING  
 C. E. DU FREECOOLING/P. FÜR FREIE KÜHLUNG

ARRIR ACTUADOR DE COMPUERTA (ENTRADA AIRE FRESCO 100%)  
 OPEN DAMPER ACTUATOR (FRESH AIR INLET 100%)  
 OUVRIER MOTEUR DU VOLET (ENTRÉE AIR NEUF A 100%)  
 OFFNE FRISCHLUFTKLAPPE (100% FRISCHLUFTZUFUHR)

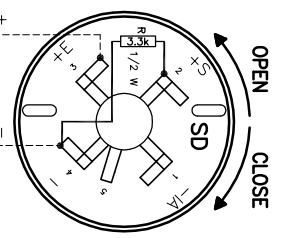
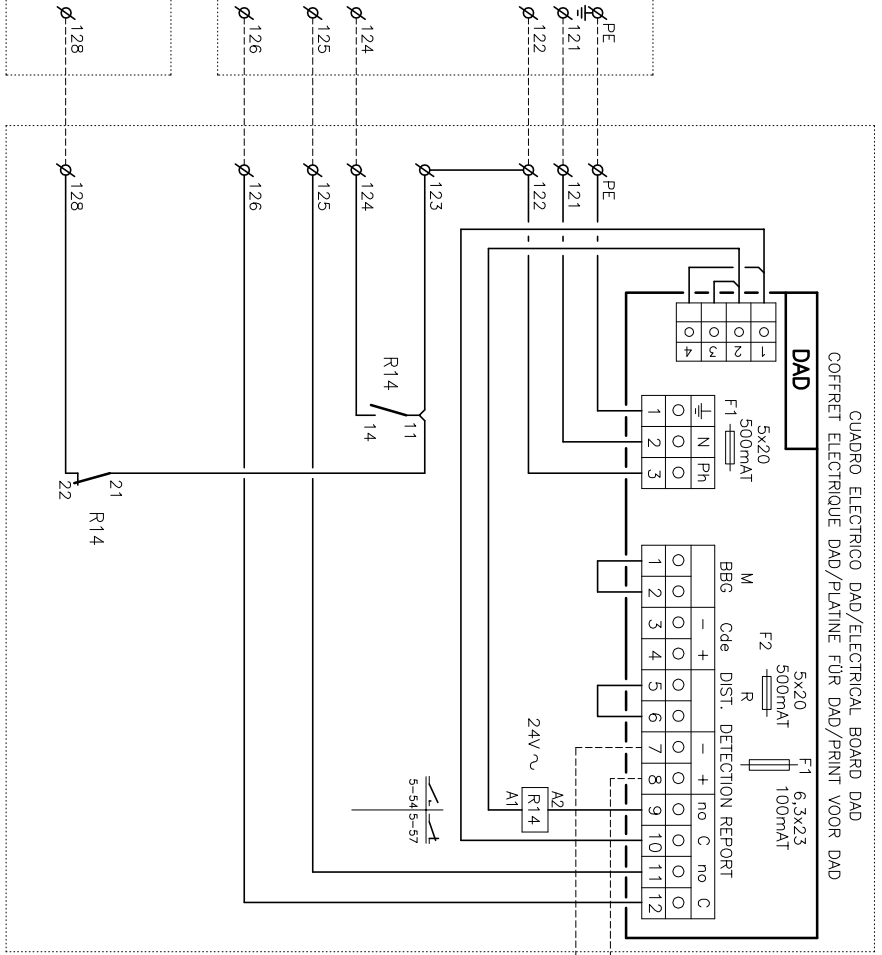

Elemento Opcional  
 Optional Element  
 Élément optionnel  
 Optionales bauteil

A realizar por el instalador  
 To wire by the installer  
 A câbler par l'installateur  
 Verdrahtung durch den installateur

5/6

Lennox Refrac S.A.

ESQUEMA ELECTRICO  
 ELECTRIC DIAGRAM

**ANHM 26E-32E-38E-43E**  
**(LEHM+KNHM)**

4Z-33-411-417 08W  
 3N ~ 400V 50Hz + PE

	0	5	10	15	20	25	30	35	40	45	50	55	60	65	70	75	80	85	90	95
AS/RS BM40 Cd CH CFM CM DAD DM DPT DI40 EH EH F1-7 F20 F21-22-23 F31-34 F35-36-38-39 FC FM FSC HP1-2 HPR-1-2 HWC IS1-2 Iq(LRA) Im(MCC) K LD LP1-2 MT MTR OS PT1-2 Q Q1 Q2 R1-20 RC RFM RV1-2 SC SD SFS SV TF1-2	LEYENDA	LEGEND	REFERENCE	LEGENDE																
	Sonda temperatura ambiente remoto Modulo logico Condensador Resistencia de carter Motor ventilador exterior Motor compresor Control deteccion de humos Servomotor compuerta Detector filtros sucos Modulo TTL-485 Ventilador de extraccion Bateria electrica Magnetoeléctrico Fusible del TF1-SC Modulo protección compresor Protección térmica Freecooling Motor ventilador interior Control de condensación Presostato de alta Presostato CPC Bateria agua caliente Sonda temperatura bateria interior 1 Intensidad de arranque Intensidad máxima Contactor Kit larga distancia tuberia Presostato baja Termostato seguridad (70°C automático) Termostato seguridad (105°C manual) Sonda temperatura exterior Transductor de presión refrigerante Interruptor general Interruptor diferencial Interruptor magnetoeléctrico Relé auxiliar Control Remoto Ventilador de retorno Válvula inversora (frío ON) Relé control de secuencia-fallo de fases Sensor detector de humos Arrancador suave Válvula solenoide Transformador	Ambient remote sensor Logic Module Capacitor Crankcase heater Compressor fan motor Compressor motor Smoke detection control Dampner actuator Dirty filter detector TTL-485 Module Exhaust fan Electrical heater Circuitbreaker Circuitbreaker TF1-SC fuse Compressor protector module Thermal protection Freecooling Indoor fan motor Fan speed control High pressure pressostat CPC pressure switch Hot Water Coil Indoor coil temperature sensor 1 Starting current Maximum current Contactor Kit piping long distance Low pressure pressostat Safety thermostat (open 70° autom. reset) Safety thermostat (open 105° manu. reset) Outdoor temperature sensor Refrigerant pressure transducer Main switch Ground safety switch Circuit breaker Auxiliary relay Remote Control Return Fan Motor Reversing valve (cooling ON) Phase sequence and failure control relay Smoke detection sensor Soft starter Solenoid valve Transformer	Sonde temp. à distance Module de Control Condensateur Résistance de carter Moteur ventilateur extérieur Compresseur Détecteur fumées Servomoteur registre Décteurur filtres encrassés Module de TTL-485 Ventilateur d'extraction Résistance électrique Disjoncteur Disjoncteur Fusible TF1-SC Module protection du compresseur Protection thermique Freecooling Moteur ventilateur inférieur Ventilateur de vitesse du ventilateur Pressostat HP Pressostat du control de pression condensation la bobine de l'eau chaude Sonde temp. batterie interieures 1 Intensité de démarrage Intensité maximal Contacteur Kit longues distances tuyauterie Pressostat BP T. sécurité (70°C automatique) T. sécurité (105°C manuel) Sensur extérieure du température Transducteur de pression Interrupteur général Interrupteur différentiel Interrupteur magneto thermique Relais auxiliaire Ventilateur de reprise Contôleur de débit Vanne 4 voirs (active en mode froid) Décteurur de phases Tête de détection de fumées Démoureur progressif Vanne solénoïde Transformateur	Umgebungsferntföher Logic Modul Kondensator Kübelwärmehheizung Kondensatorlüftermotor Kompressor Ausseleinheitrauchmelder Klappenantrieb Differenzdruckwächter TTL-485 Modul Abzüflüfer Heizstufe Motor/SchutzSchalter Motor/SchutzSchalter TF1-SC Schutz Therm. Kompressorrelais Therm. Relais Freie-Kühlung Innenventilatormotor Kondensationsdruckregelung Hochdruckpressostat Kondensationsdruckregelungpressostat Warmwasserheizregister Temperaturfühler Verdampfer 1 Anlaufstrom Maximale stromstärke Schütz Kit für lange Leitung Niederdruckpressostat Sicherheitsther. (70° automatisch) Sicherheitsther. (105° manuell) Außertemperaturfühler Drucktransmitter HauptISchalter Schalter Motor/SchutzSchalter Hilfsrelais Stromungswächter/SchwimmSchalter Rückzüflüfermotor Urn/Schaltrelais (kühlen ON) Phasenfolgeüberwachung+Störmel Rauchmelder Softstarter/Sanftanlauf Magnetventil Transformator																
	CODIGO DE COLORES	COLOUR CODE	CODE COLEUR	FARBKENNUNG																
	negro brn rd or yl gn bl vi gr wh	black brown red orange yellow green blue violet gray white	noir brun rouge orange jaune vert bleu violet gris blanc	schwarz braun rot orange gelb grün blau violett grau weiss																

6/6

Lennox Refrac S.A.

ESQUEMA ELECTRICO  
ELECTRIC DIAGRAM

ANHM

26E-32E-38E-43E  
(LEHM+KNHM)

4Z-33-411-417  
3N ~ 400V 50Hz + PE  
08M