

Application guide

RDF300.02 Remote control

- Providing indoor climate comfort



Table of contents

1	Summary	2
1.1	Brief description	2
1.2	Features	2
1.3	Type summary.....	3
1.4	Accessories	4
2	Use	4
3	Functions	5
3.1	Temperature control	5
3.2	Operating modes.....	6
3.3	Setpoints	7
3.4	Applications.....	8
3.5	Additional features	9
3.6	Control sequences	11
3.6.1	2-pipe fan coil unit.....	11
3.6.2	2-pipe fan coil unit with electrical heater	12
3.6.3	4-pipe fan coil unit.....	14
3.7	Control output.....	16
3.8	Fan control	17
3.9	Multifunctional input	19
3.10	Auto Timer (RDF400... only).....	20
3.11	Error handling.....	22
3.12	Infrared remote control.....	22
3.13	DIP switch	22
3.14	Control parameters	23
4	Handling	26
4.1	Mounting and installation	26
4.2	Operating Instructions	27
4.3	Disposal.....	27
5	Engineering	28
5.1	Connection terminals	28
5.2	Connection diagrams	28
5.2.1	Water-based fan coil applications with RDF300.../RDF400.....	28
5.2.2	Compressor-based applications with RDF300.../RDF400.....	29
5.2.3	Water-based fan coil applications with RDF340.....	30
6	Mechanical design	31
6.1	Dimensions.....	32
7	Technical data	33

1 Summary

1.1 Brief description

The devices support:

- 2-pipe, 2-pipe with electrical heater and 4-pipe fan coil units
- Compressors in DX-type equipment
- **RDF300/RDF400 AC 230 V operating voltage, on/off or 3-position control outputs**
- **RDF340... AC 24 V operating voltage, DC 0...10 V control outputs**
- **Output for 3-speed or 1-speed fan**
- **Two multifunctional inputs for keycard contact, external sensor, etc.**
- **Operating modes: Comfort, Energy Saving and Protection**
- **Automatic or manual heating/cooling changeover**
- **Adjustable commissioning and control parameters**
- **Minimum and maximum setpoint limitation**
- **Mounting on recessed rectangular conduit box, 60.3 mm fixing centers**

Additional RDF300.02 features

- Backlit LCD

Additional RDF400.01 features

- Backlit LCD
- Infrared remote control receiver
- Auto Timer mode with 8 programmable timers

1.2 Features

- Maintain room temperature via built-in temperature sensor or external room temperature / return air temperature sensor
- Automatic or manual changeover between heating and cooling mode
- Select applications via DIP switches
- Select operating mode via the operating mode button on the controller
- Single or 3-speed fan control (automatic or manual)
- Display current room temperature or setpoint in °C and/or °F
- Minimum and maximum setpoint limitation
- Keypad lock (automatic and manual)
- Two multifunctional inputs, freely selectable for:
 - Operating mode switchover contact (key card)
 - Automatic heating/cooling changeover sensor
 - External room temperature or return air temperature
 - Dewpoint sensor
 - Electrical heater enable
 - Alarm input
- Advanced fan control function, i.e. fan kick, fan start, selectable fan operation (enable, disable or depending on heating or cooling mode)
- Purge function together with 2-port valve in a 2-pipe changeover system
- Reminder to clean filters
- Floor heating temperature limit
- Reload factory settings for commissioning and control parameters
- Weekly time program: 8 programmable timers to switch over between Comfort and Economy mode (RDF400.01)
- Optional backlit LCD (RDF300.02/RDF400.01)
- Optional infrared remote control (RDF400.01)

1.3 Type summary

Product number	Features							
	Operating voltage	Control output			Time program	Backlit LCD	Infrared receiver ¹⁾	Housing color
		on/ off	3pt	DC 0..10 V				
RDF300	AC 230 V	✓	✓					white
RDF300.02	AC 230 V	✓	✓			✓		white
RDF300.02/SL	AC 230 V	✓	✓			✓		silver
RDF400.01	AC 230 V	✓	✓		✓	✓	✓	white
RDF400.01/SL	AC 230 V	✓	✓		✓	✓	✓	silver
RDF340	AC 24 V			✓				white

1) Order infrared remote control separately

1.4 Accessories

Type of unit	Product number	Data sheet
Changeover sensor mounting kit (50 pcs/package)	ARG86.3	1840
Adapter plate 82mm x 82 mm x 10 mm for conduit	ARG70.3	--

2 Use

To control the room temperature in individual rooms and zones that are:

- Heated or cooled with 2-pipe fan coil units
- Heated or cooled with 2-pipe fan coil units with electrical heater
- Heated and cooled with 4-pipe fan coil units
- Heated or cooled with compressor in DX-type equipment
- Heated or cooled with compressor in DX-type equipment with electrical heater
- Heated and cooled with compressor in DX-type equipment

The RDF300.../RDF400... controls:

- One single or 3-speed fan
- One or two on/off valve actuators
- One on/off valve actuator and one 1-stage electrical heater
- One 3-position valve actuator
- One 1-stage compressor in DX-type equipment or one 1-stage compressor with electrical heater

The RDF340... controls:

- One single or 3-speed fan
- One or two DC 0...10 V valve actuators
- One DC 0...10 V valve actuators and one modulating electrical heater (DC 0...10 V)

Use in systems with:

- Heating or cooling mode
- Automatic heating/cooling changeover
- Manual heating/cooling changeover
- Heating and cooling mode (e.g. 4-pipe system)

3 Functions

3.1 Temperature control

General note

The setting of the control parameters (P01 etc., mentioned throughout the document) is described in section 4.14.

The controller acquires the room temperature via built-in sensor, external room temperature sensor (QAA32), or external return air temperature sensor (QAH11.1), and maintains the setpoint by issuing actuator control commands to heating and/or cooling equipment. The following control outputs are available depending on the controller type:

- On/off control (2-position) with **RDF300.../RDF400...**
- Modulating PI control with 3-position control output on **RDF300.../RDF400...**
- Modulating PI control with DC 0..10 V control output on **RDF340**

The switching differential or proportional band is 2 K for heating mode and 1 K for cooling mode (adjustable via parameters P30 and P31).





The integral action time for continuous PI control is 5 minutes (adjustable via parameter P35).

Display

The display shows the acquired room temperature or the setpoint for the current operating mode, selectable via parameter P06. The factory setting displays the current room temperature.

Use parameter P04 to display the room temperature or setpoint in °F rather than °C as needed.



If the controller is used in a system with manual heating/cooling changeover (P01=2), the heating  and cooling  symbols on the display show the fan coil or terminal unit status. Thus, the symbols are displayed even when the controller operates in the neutral zone. For all other cases, the heating  and cooling  symbols are displayed when the heating or cooling output is energized.

Concurrent display of °C and °F

Concurrent display of the current temperature or setpoint in °C and in °F (parameter P07) is possible on the controller without weekly time program.

3.2 Operating modes

Select the controller's operating mode via operating mode button  on the controller or operating mode input (e.g. keycard occupancy sensor, when X1 or X2 set to 3 (P38, P40)). A corresponding setpoint is used to maintain the room temperature at the desired level depending on the active operating mode. The following operating modes are available:

Comfort mode

In Comfort mode, the controller maintains the setpoint which can be adjusted via the +/- buttons. The fan can be set to automatic or manual fan speed: Low, medium or high.

Energy Saving

Energy Saving mode helps save energy. Select it by pressing the operating mode button  if parameter P02 is set accordingly, or if the external operating mode switchover contact is active (e.g. window contact).

Note

If the external operating mode switchover contact is active, user operations are ineffective and "OFF" is displayed. Control will then be according to energy saving setpoints (P11 and P12).





Standby

/Protection mode

In Standby mode, the system is

- protected against frost (factory setting **8°C**, can be disabled or changed via P65)
- protected against overheating (factory setting **OFF**, can be enabled or changed via P66)

Auto Timer mode (only with RDF400...)

In Auto Timer mode , the controller automatically changes from Comfort to Energy Saving mode as per the 8 preprogrammed timers. The display shows the Auto Timer mode symbol  along with the symbol for the current operating mode (Comfort  or Economy ).

Automatic is the default fan speed in Auto Timer mode.

3.3 Setpoints

Comfort mode ☼

The setpoint in Comfort mode can be adjusted via the +/- buttons.

Setpoint limitation

For energy saving purposes, the setpoint adjusting range can be limited to minimum (P09) and maximum (P10).

P09 < P10

- If the minimum limit **P09 is set lower** than the maximum limit P10, both heating and cooling are adjustable between these two limits.

P09 ≥ P10

- For heating **or** cooling applications (e.g. 2-pipe)
 - The setting range in cooling mode is from **P09...40°** instead of 5...40°
 - The setting range in heating mode is from **5...P10°** instead of 5...40°
- For heating **and** cooling applications (e.g. 4-pipe)
 - **P09** is the setpoint for cooling and **P10** the setpoint for heating;
 - the setpoint can no longer be adjusted via the +/- buttons

Examples	2-pipe Heating OR cooling	4-pipe Heating AND cooling
P09 < P10	<p>5°C 18°C 25°C 40°C P09 P10</p> <p>Cooling setpoint adjustable 18...25°C Heating setpoint adjustable 18...25°C</p>	<p>5°C 18°C 25°C 40°C P09 P10</p> <p>Cooling setpoint adjustable 18...25°C Heating setpoint adjustable 18...25°C</p>
P09 ≥ P10	<p>5°C 21°C 25°C 40°C P10 P09</p> <p>Cooling settable 25...40°C Heating settable 5...21°C</p>	<p>Cooling fixed = 25°C (P09) Heating fixed = 21°C (P10)</p>

Temporary setpoint

If the "Temporary setpoint function" is enabled via parameter P69, the setpoint adjusted via the +/- buttons is set back to the Comfort basic setpoint when the operating mode changes.

The factory setting for the Comfort basic setpoint is **21 °C** and can be changed via parameter P08.

Energy Saving mode ☾

Use control parameters P11 and P12 to adjust the Economy mode setpoints.

The heating setpoint is factory-set to **15 °C** and to **30 °C** for cooling.

Standby mode ⏻

Use control parameters P65 and P66 to adjust the Standby mode setpoints.

The heating setpoint is factory-set to **8 °C** (frost protection) and to **OFF** for cooling.







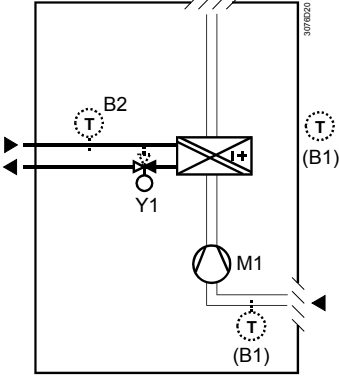

Caution ⚠

If a setpoint is set to OFF (P65, P66), the controller does not maintain the setpoint in the corresponding mode (heating or cooling).

This means no protective heating or cooling function and thus risk of frost in the heating mode or risk of overheat in cooling mode!

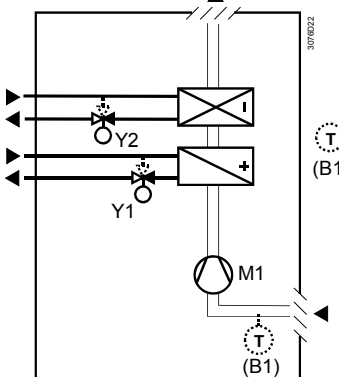
3.4 Applications

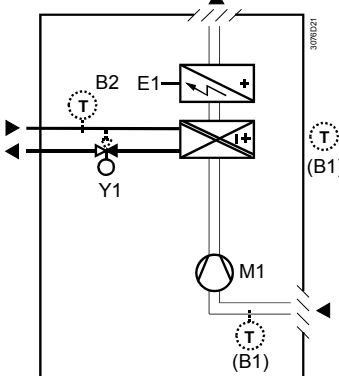
The controller supports following applications, which can be configured by DIP-switches on the inner side of the controller front panel. Depending on the type, on/off or modulating control outputs are available.

Application and Control output	Type reference	DIP-switch	Diagram	
2-pipe fan coil unit, heating and cooling	2-pipe/1-stage compressor on/off	RDF300 RDF400		
	2-pipe modulating, 3-position	RDF300 RDF400		
	2-pipe modulating, DC 0...10 V	RDF340		
4-pipe fan coil unit, heating and cooling	4-pipe/compressor for H+C on/off	RDF300 RDF400		
	4-pipe modulating, DC 0...10 V	RDF340		
2-pipe fan coil unit with electrical heater, heating or cooling with auxiliary heater	2-pipe/1-stage compressor with electrical heater on/off	RDF300 RDF400		
	2-pipe with electrical heater modulating, DC 0...10 V Note: Modulating electrical heater	RDF340		

Key	Y1	Heating or heating/cooling valve actuator	M1	3-speed or single-speed fan
	Y2	Cooling valve actuator	B1	Return air temperature sensor or external room temperature sensor (optional)
	E1	Electrical heater	B2	Changeover sensor (optional)

Note: The diagrams above show only the water based fan coil application, but not compressor!

Water-based fan coil application

Use with one or two valves for heating and cooling, heating/cooling with changeover, heating only, or cooling only.

Compressor-based application

Use with one 1-stage compressor for heating and cooling, or cooling only, or heating only.

Universal applications

Thanks to a flexible fan control, the RDF3xx / RDF4xx can also be used in universal applications, e.g. fan coil-based cooling and floor heating, or chilled ceiling and electrical heater etc. See also section 4.8 "Fan control".

3.5 Additional features

Automatic H/C changeover

The water temperature acquired by the changeover sensor (QAH11.1 + ARG86.3) is used to change over from heating to cooling mode and vice-versa. When the water temperature is above 28 °C (parameter P37), the controller changes over to heating mode, and to cooling mode when below 16 °C (parameter P36). If the water temperature is between the 2 changeover points immediately after power up, the controller starts in heating mode.

The water temperature is acquired at 30-second intervals and the operating state is updated accordingly.

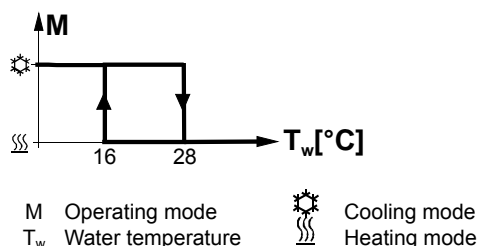

Remote heating/cooling changeover

The QAH11.1 cable temperature sensor for automatic heating/cooling changeover can be replaced by an external switch for manual, remote changeover:

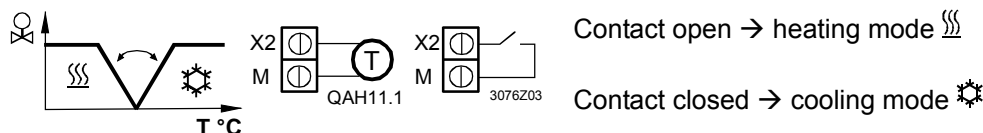

The sensor or switch can be connected to the input terminal of X2 (factory setting) or X1 depending on the commissioning of inputs X1 and X2. See also section 4.9 "Multifunctional input".

External / return air temperature sensor

The controller acquires the room temperature via built-in sensor, external room temperature sensor (QAA32), or external return air temperature sensor (QAH11.1) connected to multifunctional input X1 or X2.

Inputs X1 or X2 need to be commissioned accordingly. See section 4.9 "Multifunctional input".

Purge function

The changeover sensor is tasked with initiating changeover from heating to cooling mode based on the acquired water temperature. We recommend activating the purge function (parameter P50) with 2-port valves. This function ensures correct acquisition of the medium temperature even if the 2-port valve is closed for an extended period of time. The valve is then opened for 1 to 5 minutes (adjustable) at 2-hour intervals during off-hours.

Caution 

The purge function (parameter P50) must be disabled if the controller is to be used in compressor-based applications.

Avoid damage from moisture

In very warm and humid climates, the fan can be run periodically or continuously at a low fan speed (e.g. in empty apartments or shops) in Energy Saving mode by setting parameter P61 to avoid damage from moisture due to a lack of air circulation. See also section 4.8 “Fan control”, under “Fan kick function”.

Minimum output on-time/off-time

Limit the on/off switching cycle to protect the compressor and reduce wear and tear. The minimum output on-time and off-time for 2-position control output Y11/Y21 can be adjusted from 1 to 20 minutes via parameters P48 and P49. The factory setting is 1 minute. Readjusting the setpoint or heating/cooling mode changeover immediately results in calculation of the output status; controller output Y11/Y21 may not hold the min. 1-minute on/off time. If parameter P48 or P49 is set to above 1 minute, the min. on/off time for Y11 is maintained as set, even if setpoint or changeover mode is readjusted. This function is only available for on/off control.

Floor heating limitation function

The floor heating limitation function is a part of the floor heating application (heating with fan disabled). The floor temperature sensor, connected to multifunctional input X1 or X2, measures the floor temperature. If the temperature exceeds the parameterized limit (parameter P51), the heating valve is fully closed until the floor temperature drops to 2K below the parameterized limit. This function is factory-set to OFF (disabled). Input X1 or X2 must be commissioned accordingly (P38 or P40 = 1). See section 4.9 “Multifunctional input”.

Parameter P51	External temperature sensor available	Source for display of room temperature	Output control according to	Floor temperature limit function
OFF	No	Built-in sensor	Built-in sensor	Not active
OFF	Yes	External temp	External temp. sensor	Not active
10...50°C	No	Built-in sensor	Built-in sensor	Not active
10...50°C	Yes	Built-in sensor	Built-in sensor + limit by external sensor	Active

Dewpoint monitoring

Dewpoint monitoring is essential to prevent condensation on the chilled ceiling (cooling with fan disabled). It helps to avoid associated damage to the building. A dewpoint sensor with a voltage-free contact is connected to multifunctional input X1 or X2. If there is condensation, the cooling valve is fully closed until no more condensation is detected, and the cooling output is disabled temporarily. The condensation symbol  is displayed during temporary override. Input X1 or X2 must be commissioned accordingly. See section 4.9 “Multifunctional input”.

Keypad lock

If the keypad lock function is enabled by parameter P14, then the keypad will be locked or unlocked by pressing 7 seconds on the operating mode button . If “Auto lock” is configured, then the controller will automatically lock the keypad 30 seconds after the last adjustment.

3.6 Control sequences

The controller can be used in systems featuring:

- Heating or cooling mode (P01=0 or P01=1)
- Manual heating/cooling changeover (P01=2)
- Automatic heating/cooling changeover (P01=3)
- Heating and cooling mode (e.g. 4-pipe system) (P01=4)

The relevant modes are available and can be adjusted via commissioning parameter “Control sequence” P01, depending on the selected application.

Sequence					
Parameter	P01 = 0	P01 = 1	P01 = 2	P01 = 3	P01 = 4
Mode	Heating mode	Cooling mode	Manually select heating or cooling mode	Automatic heating/cooling changeover via external water temperature sensor or remote switch	Heating and cooling mode, i.e. 4-pipe
Available for:					
2-pipe, 2-pipe & el. heater	✓	✓	✓	✓	
4-pipe			✓	✓	✓

3.6.1 2-pipe fan coil unit

On/off output
Heating or cooling

In 2-pipe applications, the controller controls a valve in heating/cooling mode with changeover (automatic or manual), heating only mode, or cooling only mode. Cooling only is factory set (P01=1).

Control sequence
on/off output

The diagram below shows the control sequence for on/off (2-position) control.

Heating mode

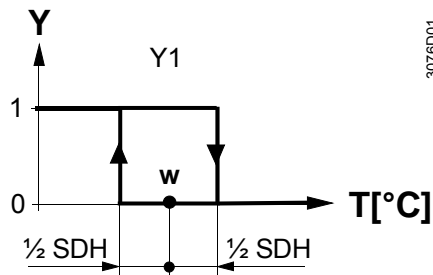

Cooling mode

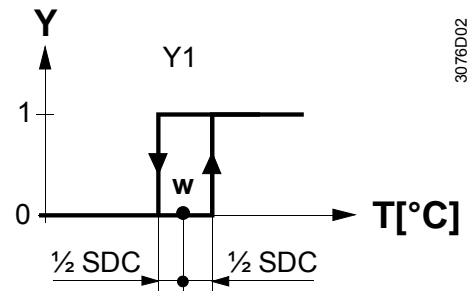

T[°C] Room temperature
w Room temperature setpoint
Y1 Control command “Valve” or “Compressor”

SDH Switching differential “Heating”
SDC Switching differential “Cooling”

Control sequence
modulating output

The diagram below shows the control sequence for continuous PI control.

Heating mode

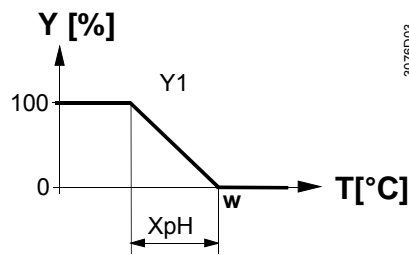

3076D03

Cooling mode

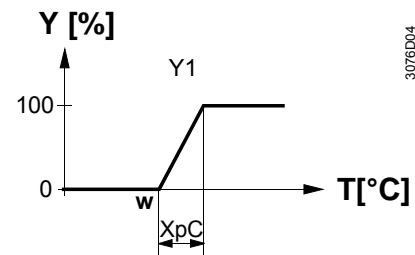

3076D04

T[°C]	Room temperature	XpH	Proportional band "Heating"
w	Room temperature setpoint	XpC	Proportional band "Cooling"
Y1	Control command "Valve"		

Note

The diagrams only show the PI controller's proportional part

3.6.2 2-pipe fan coil unit with electrical heater

Heating or cooling with
auxiliary heater

In 2-pipe applications with electrical heater, the controller controls a valve in heating/cooling mode with changeover, heating only mode, or cooling only mode plus auxiliary electrical heater. Cooling only is factory set (P01=1) with enabled electrical heater (P13).

Electrical heating,
active in cooling mode

In cooling mode, the valve receives an **OPEN** command if the acquired temperature is above the setpoint. The electrical heater receives an **ON** command if the acquired room temperature drops below "setpoint" – "dead zone" (= "setpoint for electrical heater") while the electrical heater is enabled (parameter P13).

Note: "Setpoint for electrical heater" is limited by parameter "Maximum heating setpoint" (P10).

Electrical heating in
heating mode

In heating mode, the valve receives an **OPEN** command if the acquired temperature is below the setpoint. The electric heater is used as additional heating source when the heating energy controlled by the valve is insufficient. The electrical heater receives an **ON** command, if the temperature is below "setpoint" – "setpoint differential" (=setpoint for electrical heater).

Electrical heating, and
manual changeover

The electrical heater is active in heating mode only and the control output for the valve is permanently disabled when manual changeover is selected (P01=2).

Digital input "Enable
electrical heater"

Remote enabling/disabling of the electrical heater is possible via digital input X1/X2 for tariff regulations, energy saving etc.

Input X1 or X2 must be commissioned accordingly. See section 4.9 "Multifunctional input".

Control sequence
on/off output

The diagram below shows the control sequence for on/off (2-position) control.

Heating mode

(automatic changeover=heating or heating only)

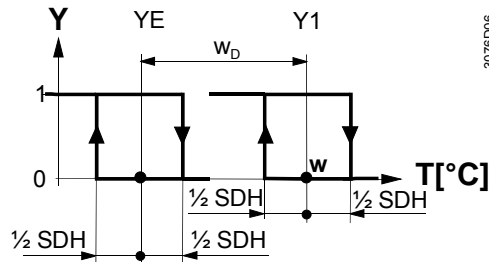

Cooling mode

(man. /auto. changeover=cooling or cooling only)

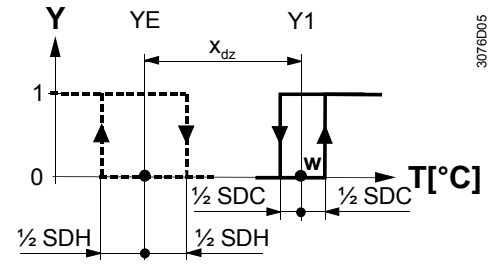

Heating mode with manual changeover
(P01=2)

(manual changeover=heating)

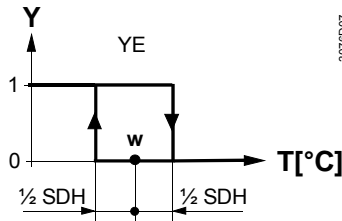

- T[°C] Room temperature
- W Room temperature setpoint
- Y1 Control command "Valve" or "Compressor"
- YE Control command "electrical heater"
- SDH Switching differential "Heating"
- SDC Switching differential "Cooling"
- X_{dz} Dead zone
- w_D Setpoint differential

Control sequence
modulating output

The diagram below shows the control sequence for continuous PI control.

Heating mode

(automatic changeover=heating or heating only)

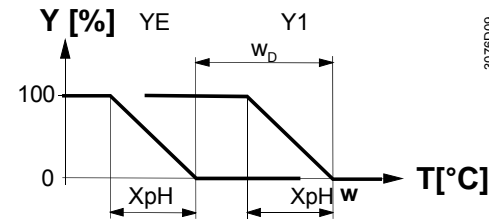

Cooling mode

(man. /auto. changeover=cooling or cooling only)

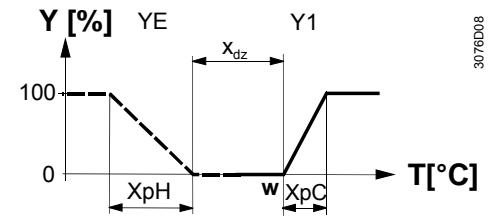

Heating mode with manual changeover
(P01=2)

(manual changeover=heating)

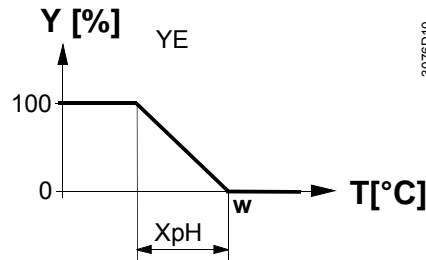

- T[°C] Room temperature
- W Room temperature setpoint
- Y1 Control command "Valve"
- YE Control command "electrical heater"
- X_{pH} Proportional band "Heating"
- X_{pC} Proportional band "Cooling"
- X_{dz} Dead zone
- w_D Setpoint differential

Note: The diagrams only show the PI controller's proportional part.

3.6.3 4-pipe fan coil unit

Heating and cooling

In 4-pipe applications, the controller controls two valves in heating and cooling mode, heating/cooling mode by manual selection, or heating and cooling mode with changeover. Heating and cooling mode (P01=4) is factory set.

4-pipe application with manual selection

The heating or cooling output can be released via operating mode selector button if parameter P01 is set to manual (P01=2).

“Main and Secondary” application (4-pipe with changeover)

The heating and cooling output is swapped per the sensor input status (see automatic heating and cooling changeover sensor), if parameter P01 is set to changeover (P01=3). This mode is used for “Main and Secondary” application, which equates to a 4-pipe fan coil unit system with different capacity for heating and cooling coils. The water circuit is changed to optimize the energy exchange depending on the season (summer/winter).

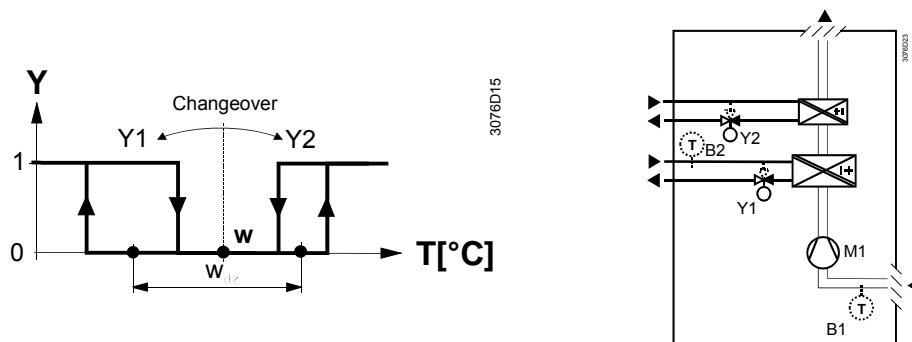

Control sequence on/off output

The diagram below shows the control sequence for on/off (2-position) control.

Heating and cooling mode (P01=04)

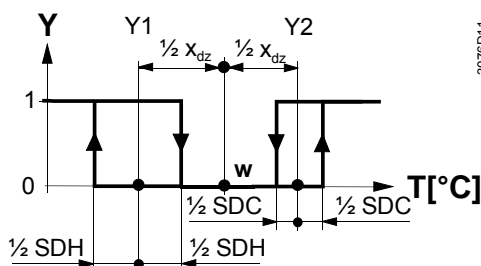

- T[°C] Room temperature
- w Room temperature setpoint
- Y1 Control. command “Valve” or “Comp.” Heat
- Y2 Control. command “Valve” or “Comp.” Cool
- SDH Switching differential “Heating”
- SDC Switching differential “Cooling”
- X_{dz} Dead zone

Heating mode with manual selection (P1=2)

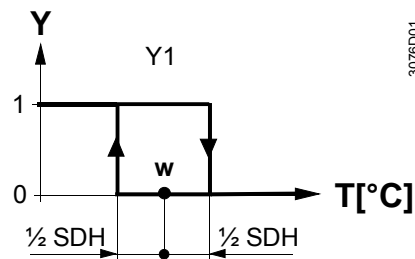

Cooling mode with manual selection (P1=2)

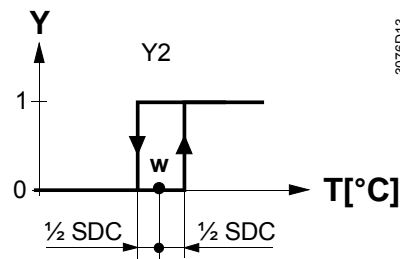

Control sequence modulating output

The diagram below shows the control sequence of a continuous PI control.

Heating and cooling mode (P01=04)

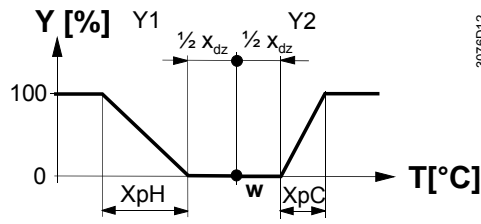

3076D12

- T[°C] Room temperature
- w Room temperature setpoint
- Y1 Control command "Valve" Heating
- Y2 Control command "Valve" Cooling
- XpH Proportional band "Heating"
- XpC Proportional band "Cooling"
- Xdz Dead zone

Heating mode with manual selection (P1=2)

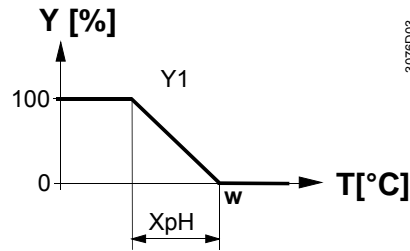

3076D03

Cooling mode with manual selection (P1=2)

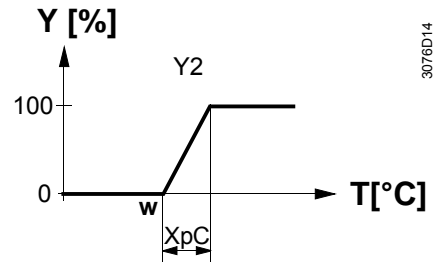

3076D14

This function (4-pipe modulating) is only available with RDF340 (2 analog outputs DC 0...10 V are required).

Note: The diagrams only show the PI controller's proportional part.

3.7 Control output

Overview of control outputs

Different control output signals are available depending on the controller type.

Control output Type reference	on/off	3-position	DC 0...10 V
RDF300...	Y11, Y21 (2)	Y11/Y21 (1)	
RDF400...	Y11, Y21 (2)	Y11/Y21 (1)	
RDF340...			Y10, Y20 (2)

() Number of outputs

on/off control signal (2-position)

The valve or compressor receives the **OPEN/ON** command via control output Y11 or Y21:

1. When the acquired room temperature is below the setpoint (heating mode) or above the setpoint (cooling mode).
2. When control outputs Y11/Y21 were not energized for more than the "Minimum output off time" (factory setting 1 minute, adjustable via parameter P48).

The valve or compressor receives the **CLOSE/OFF** command via control output Y11 or Y21:

1. When the acquired room temperature is above the setpoint (heating mode) or below the setpoint (cooling mode).
2. When control outputs Y11/Y21 were energized for more than the "Minimum output on time"; (factory setting 1 minute, adjustable via parameter P49).

3-position control signal

Output Y11 provides the **OPEN** command, and Y21 the **CLOSE** command to the 3-position actuator. The factory setting for the runtime is 150 seconds (adjustable via parameter P44 from 50...240 seconds).

1. When the controller gets powered up, a closing command for the actuator runtime + 20% is provided to ensure that the actuator fully closes and synchronizes to the control algorithm.
2. When the controller calculates the positions fully close or fully open, the actuator runtime is extended + 20% to ensure the right actuator position synchronized to the control algorithm.
3. After the actuator reaches the position calculated by the controller, a waiting time of 30 seconds is applied to stabilize the outputs.

Electrical heater control signal (2-position)

The electrical heater receives an **ON** command via the auxiliary heating control output Y21:

1. When the acquired room temperature is below "setpoint for electric heater".
2. When the electrical heater has been switched off for more than 1 minute.

The **OFF** command for the electrical heater is output:

1. When the acquired room temperature is above the setpoint (electric heater).
2. When the electrical heater has been switched on for more than 1 minute.

Caution 

A safety thermostat (to prevent overheating) must be provided externally.

DC 0..10 V control signal

The demand calculated by PI control from the current room temperature and setpoint is provided via Y10 and Y20 to the valve actuator as a continuous DC 0...10 V signal.

3.8 Fan control

The fan operates in automatic mode or at the selected speed with manual mode. In automatic mode, the fan speed depends on the setpoint and the current room temperature. When the room temperature reaches the setpoint, the control valve closes and the fan switches off or stays at fan speed 1 (parameter P60, factory setting: fan speed 1 in dead zone).

The individual switching points for **ON** of each fan stage can be adjusted via control parameters P55 – P57. The fan speed switch-off point is 20% below the switch-on point. The diagram below shows fan speed control for continuous PI control.

Fan control with modulating control

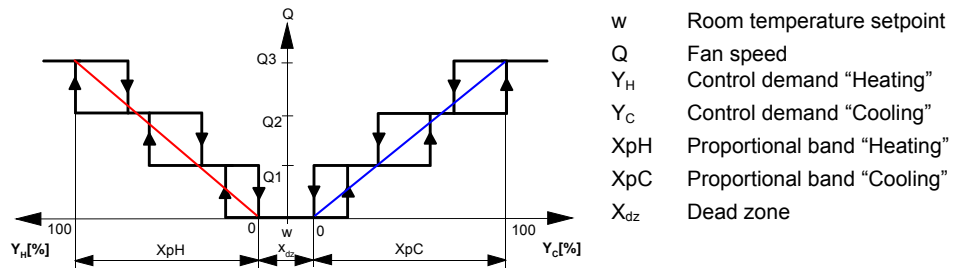

Note: The diagram only shows the PI controller's proportional part.

Fan control with on/off control

In applications with on/off control (2-position):

- 1) The switching point for low fan speed (Q1) is synchronized to the heating/cooling output. Parameter "Switching point fan speed low" P57 is not relevant.
- 2) The maximal switching range of the fan ($X_{pH_{Fan}}, X_{pC_{Fan}}$) is defined by the switching differential (SDH/SDC) via a look-up table.

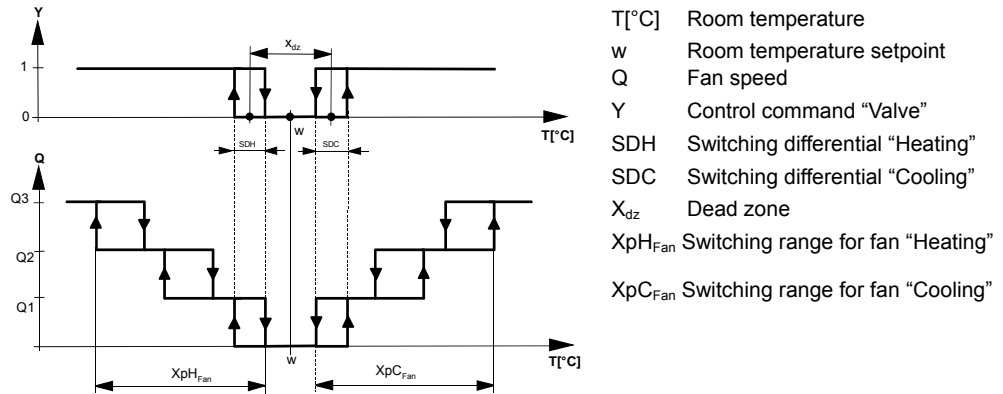

Look-up table with on/off control

SDH/SDC [K]	0.5	1.0	1.5	2.0	2.5	3.0	3.5	4.0	>4.5
$X_{pH_{Fan}}/X_{pC_{Fan}}$ [K]	2	3	4	5	6	7	8	9	10

3-speed/1-speed fan

The fan speed controller can control a 3-speed or single-speed fan (selected via control parameter P53). A single-speed fan is connected to terminal Q1, a 3-speed fan to terminals Q1, Q2 and Q3.

Fan operation as per heating/cooling mode, or disabled

Fan operation can be limited to be active only in cooling or heating mode, or even totally disabled via control parameter "Fan operation" P52. When fan operation is disabled, the fan symbol on the display disappears and actuating the fan button has no influence. This function allows for using the controller in universal applications such as floor heating with fan coil cooling etc.

Fan minimum on-time

In automatic mode, a dwelling time of 2 minutes (factory setting) is active. The fan maintains each speed for at least 2 minutes before it changes to the next speed. This minimum on-time can be adjusted from 1...5 minutes via parameter P59.

Fan operation in dead zone

In automatic fan mode and with the room temperature in the dead zone, the control valve normally is closed and the fan is disabled. With the fan kick function, the fan can be released from time to time at low speed for minimum on-time (see above) even if the valve is closed.

This function can be used to avoid damage from moisture due to a lack of air circulation, or to allow a return air sensor to measure the correct room temperature.

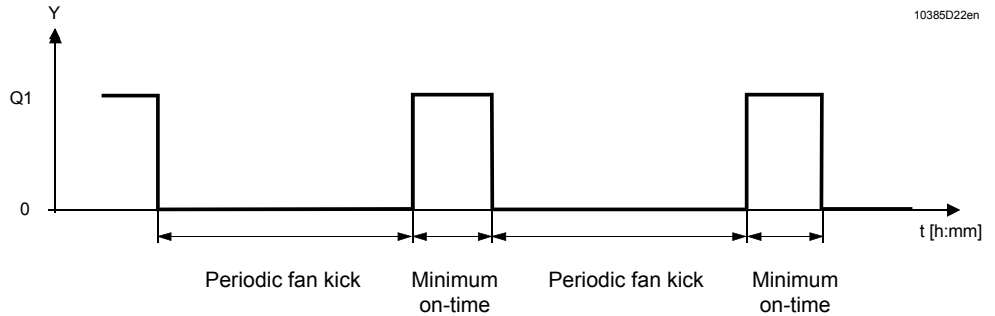

The periodic fan kick time can be selected individually for Comfort mode via parameter P60 and for Energy Saving mode via parameter P61.

Note: Fan kick value "0" means the fan runs continuously in the dead zone.
Fan kick value "OFF" means the fan is not running in the dead zone.

Fan start

When the fan starts from standstill, it starts at speed 3 for 1 second to guarantee safe fan motor start by overcoming inertia and friction (selected via parameter P58).

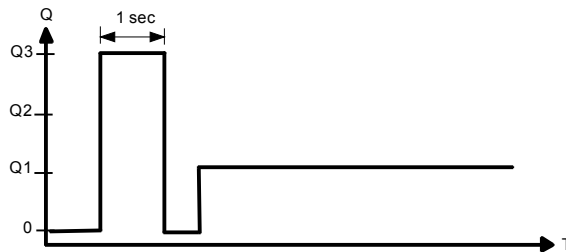

Fan overrun for electric heater

When the electrical heater is switched off, the fan overruns for 60 seconds (parameter P54) to avoid overtemperatures of the electrical heater or prevent thermal cutout from responding.

⚠ Fan failure

In case of fan failure, the controller cannot protect the electrical heater against overtemperatures. That is why the electrical heater must feature a separate safety device (thermal cutout).

Clean fan filter reminder

The clean fan filter reminder function counts the fan operating hours and displays message "FIL"  to remind the user to clean the fan filter as soon as the threshold is reached. This does not impact controller operations, which continues to run normally.

The clean filter reminder is reset when the operating mode is manually set to Standby or Protection respectively .

Fan in Auto Timer mode (RDF400... only)

In Auto Timer mode, default fan mode is automatic. The fan mode can be changed to manual by pushing the "FAN" button. The fan returns to the automatic default mode after each switchover from Comfort to Energy Saving and vice-versa.

3.9 Multifunctional input

The controller offers two multifunctional inputs X1 and X2. A sensor of type NTC like QAH11.1 (AI) or a switch (DI) can be connected to the input terminals. The functionality of both inputs can be configured via parameters P38 for input X1 and P40 for input X2.

#	Function of input X1/X2	Description	Type
0	Not used	No function.	-
1	External/Return air temp.	Sensor input for external room temperature sensor or return air temperature sensor to measure the current room temperature, or floor heating temperature sensor to limit the heating output. <i>Note:</i> The room temperature is measured by the built-in sensor if the floor heating limitation function is enabled via parameter P51.	AI
2	Heat/cool changeover	Sensor input for automatic heating / cooling changeover function. A switch can also be connected rather than a sensor (switch closed = cooling, see section 4.5).	AI/(DI)
3	Operating mode switchover	Digital input to switch over the operating mode to Energy Saving. If the operating mode switchover contact is active, user operations are ineffective and "OFF" is displayed.	DI
4	Dewpoint monitor	Digital input for a dewpoint sensor to detect condensation. Cooling is stopped if condensation occurs.	DI
5	Enable electrical heater	Digital input to enable/disable the electrical heater via remote control.	DI
6	Alarm	Digital input to signal an alarm. If the input is active, "ALx" (x:=1 or 2) is displayed. <i>Note:</i> Alarm displays do not influence controller operations. They merely represent a visual signal. <i>Example:</i> dirty air filter	DI

Operational action can be changed between normally open (N.O.) and normally closed (N.C.) via parameter P39 or P41 if it is a digital input (DI).

Each function can only be assigned to input X1 or X2; only "Alarm" can be assigned to both inputs.

X1 is factory-set to "Operating mode switchover" (3) and X2 to "Heating/cooling changeover" (2).

For more information see section 4.4 "Applications".

3.10 Auto Timer (RDF400... only)

The controller provides an Auto Timer mode with 8 programmable timers. Each timer can be assigned to one or several days. In this mode, the controller automatically changes over between Comfort and Energy Saving mode as per the preprogrammed timers.

Auto Timer for Comfort mode



Auto Timer for Energy Saving mode



Set timers



Each timer has a Comfort mode start and end time that can be applied to one or several weekdays.

To adjust the time schedule, press the  button for 3 seconds to go to the programmable timer setting mode.

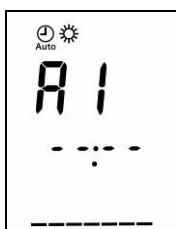

This mode is indicated by Ax (x= auto timer 1...8) and the time __: __ flashes.



Proceed as follows for each Auto Timer:

1. The  and  symbols are displayed. Press + or - to adjust the Comfort mode start time and confirm by pressing .



2. The  and  symbols are displayed. Press + or - to adjust the Comfort mode end time or Energy Saving start time and confirm by pressing .



- Symbol **1** flashes. Press + or - to select or clear each day and go to the next day. Confirm the actual timer settings by pressing ✓ and go to the next timer.



The controller closes the programmable timer setting mode if no button is pressed within 20 seconds. All changes made after pressing the ✓ button for the last time are lost.

View timers

Press the button to review the 8 timers in sequence.

Default timer setting

Timers A1...A4 have the following default settings (residential use):

Day/s	Time when controller is in Comfort mode ☀	
Mo (1) – Fr (5)	06:30 – 08:30 (A1)	17:30 – 22:30 (A2)
Sa (6)	08:00 – 23:00 (A3)	
Su (7)	08:00 – 22:30 (A4)	
	- For the remainder, the controller is in Energy Saving mode ☾. - Timers A5...A8 are open, no default setting.	

Reload default timer setting

The setting of these timers can be changed to individual needs. The default setting can be reloaded any time:

- Set the controller to Standby .
- Press + and - simultaneously for 3 seconds. Release and press twice within 2 seconds..

Then, the display will show “8888” during the reloading process.

Overlapping of timer sequences

When several timer sequences overlap, the resulting output is the OR combination of the normal operating mode time of all timers.

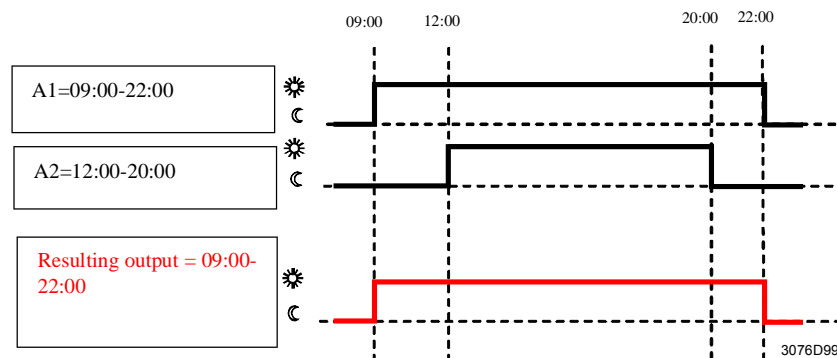

7-day time clock

The 7-day time clock supports 12 hour and 24 hour format. Select the format while setting the time clock as follows:

Set the time clock

- Press the button until the time digits start to flash and then press + or - to set the time of day. If the current time is in the 24-hour format and you want to change to 12-hour format, press + passing 23:59 or press - passing 00:00 and vice-versa to return to 24-hour format.
- Confirm the time of day by pressing ✓ and the weekday indicator starts to flash.
- Press + or - to set the current weekday.
- Confirm the current weekday by pressing ✓.

Power failure

In the event of a power failure, the clock stops, but its last time is stored. This time information is reloaded and starts running after power up. The clock flashes to indicate that there was a power failure until the time is confirmed by pressing ✓, or readjusted by following the above procedure.

3.11 Error handling

Temperature out of range

When the room temperature is outside the measuring range, i.e. above 49 °C or below 0 °C, the limiting temperatures flash, e.g. "0 °C" or "49 °C". Output Y11 is energized if the current setpoint is not set to "OFF", the controller is in heating mode and the temperature is below 0 °C. For all other cases, output Y11 is de-energized. The controller resumes Comfort mode after the temperature returns to within the measuring range.

3.12 Infrared remote control

Use the IRA210 infrared remote control to operate a controller with built-in infrared receiver. The following operations can be carried out remotely:

- Select operating modes Standby, Comfort mode or Auto Timer.
- Adjust setpoint in Comfort mode.
- Select fan modes Automatic or Manual.

A buzzer in the thermostat indicates remote control command reception. Infrared remote control can be disabled via parameter P70.

3.13 DIP switches



Use the DIP switches on the inner side of the front panel to commission the basic controller applications prior to snapping it to the base.

RDF300.../RDF400... have the following DIP switch settings:

RDF300.../RDF400...

DIP switch number	1	2
Application		
2-pipe	OFF	OFF
2-pipe, 3 position	ON	OFF
2-pipe & electrical heater	OFF	ON
4-pipe ¹⁾	ON	ON

RDF340 has the following DIP switch settings:

RDF340

DIP switch number	1	2
Application		
2-pipe	OFF	OFF
2-pipe & electrical heater	OFF	ON
4-pipe ¹⁾	ON	ON

1) Factory setting

Note: During startup, the controller reloads the control parameter factory settings after each DIP switch settings change.

3.14 Control parameters

A number of control parameters can be readjusted to optimize control performance. These parameters can also be set during operation without opening the unit. In the event of a power failure, all control parameter settings are retained.

The control parameters are divided in two levels:

- “Service” level, and
- “Expert” level

The “Service” level contains a small set of parameters to set up the controller for the HVAC system and to adjust the user interface. These parameters can usually be adjusted any time.

Change parameters in the “Expert” level only carefully, as they impact control performance and functionality of the controller.

Parameter setting

Enter only “Service” level

Change the parameters as follows:

1. Set the controller to Standby (⏻ *)
2. Press buttons + and - simultaneously for 3 seconds. Release and press button + again for 3 seconds within 2 seconds. The display shows “P01”. Continue at Step 3.

Enter “Service” and “Expert” level.

1. Set the controller to Standby (⏻ *)
2. Press buttons + and - simultaneously for 3 seconds. Release and press button - again for 6 seconds within 2 seconds. The display shows “P01” and service.

Adjust parameters

3. Select the required parameter by repeatedly pressing buttons + and -.
4. When you press buttons + and - simultaneously, the current value of the selected parameter starts to flash, which can be changed by repeatedly pressing buttons + or -.
5. When you again press buttons + and - simultaneously, the next parameter is displayed.
6. Repeat Steps 3 to 5 to display and change additional parameters.
7. All changes are saved and the controller returns to Standby 10 seconds after the last display or setting.

Reset parameters

The factory setting for the control parameters can be reloaded via parameter P71, by changing the value to “ON”, and confirming by pressing buttons + and - simultaneously. The display shows “8888” during reload.

Note! *) If one of the digital inputs is commissioned as window contact, and the contact is closed, the controller will switch to ECO mode and parameter setting will not be possible. Solution: open the window contact.

Control parameters

#	Parameter	Factory setting	Setting range	RDF300...	RDF340...	RDF400...
Service Level						
P01	Control sequence	2-pipe: [0..3] 1 (Cool only) 4-pipe: [2...4] 4 (Heat&Cool)	0:= Heating only 1:= Cooling only 2:= Manual H/C 3:= Auto changeover 4:= Heating & cooling	✓	✓	✓
P02	Mode selection via user operating mode button	1 (Stb, Comf)	1 = Stb, Comf 2 = Stb, Comf, Eco	✓	✓	✓
P04	Selection of °C or °F	°C	(0) °C or (1) °F	✓	✓	✓
P05	Sensor calibration	0.0 K	- 3 ... +3 K	✓	✓	✓
P06	Standard temperature display	0 (Room temp)	0:= Room temperature 1:= Setpoint	✓	✓	✓
P07	Additional user info	0 (no display)	0:= no display 1:= Temp in °C and °F	✓	✓	✗
P08	Comfort basic setpoint	21 °C	5 ... 40 °C	✓	✓	✓
P09	Minimum setpoint limitation for Comfort (WminComf)	5 °C	5 ... 40 °C	✓	✓	✓
P10	Maximum setpoint limitation for Comfort (WmaxComf)	35 °C	5 ... 40 °C	✓	✓	✓
P11	Heating setpoint for Energy Saving (WheatEco)	15 °C	OFF, 5 °C...WcoolEco	✓	✓	✓
P12	Cooling setpoint for Energy Saving (WcoolEco)	30 °C	OFF, WheatEco...40 °C	✓	✓	✓
P13	Electrical reheater for cooling mode	ON	ON:= enabled OFF:= disabled	✓	✓	✓
P14	Keypad lock (Press the operating mode button  for 7 seconds to enable or disable the keypad lock)	0 (Unlocked)	0:= Unlocked 1:= Auto lock 2:= Manual lock	✓	✓	✓

Note

- P02 is not available when the controller is commissioned for manual heating/cooling changeover P01=2
- Parameter display depends on selected application and function

(x) Not available

#	Parameter	Factory setting	Setting range	RDF300...	RDF340...	RDF400...
Expert Level						
P30	P-band/Switching differential for heating mode	2K	0.5 ... 6 K	✓	✓	✓
P31	P-band/Switching differential for cooling mode	1 K	0.5 ... 6 K	✓	✓	✓
P33	Dead zone in Comfort mode	2 K	0.5 ... 5 K	✓	✓	✓
P34	Setpoint differential	2 K	0.5 ... 5 K	✓	✓	✓
P35	Integral time	5 min	0...10 min	✓	✓	✓
P36	Heating/cooling changeover switching point for cooling	16 °C	10...25 °C	✓	✓	✓
P37	Heating/cooling changeover switching point for heating	28 °C	27...40 °C	✓	✓	✓
P38	X1 functionality	3 (Op mode switchover)	0:= NA 1:= Ext/Return air temp 2:= Heat/cool changeover 3:= Operating mode switch 4:= Dewpoint monitor 5:= Enable electrical heater 6:= Alarm input	✓	✓	✓
P39	Operating action for X1 if digital input	0 (N.O.)	0:= Normally open 1:= Normally closed	✓	✓	✓
P40	X2 functionality	2 (H/C c/o)	Same as P38	✓	✓	✓
P41	Operating action for X2 if digital input	0 (N.O.)	0:= Normally open 1:= Normally closed	✓	✓	✓
P44	Runtime for 3-position output (Y11/Y21)	150 s	50...240 sec	✓	✗	✓
P48	Minimum output on-time via on/off control output	1 min.	1...20 minutes	✓	✗	✓
P49	Minimum output off-time via on/off control output	1 min.	1...20 minutes	✓	✗	✓
P50	Purge function (minimum every 2 hours)	OFF	OFF: Inactive 1...5 min	✓	✓	✓
P51	Floor heating limit temperature	OFF	OFF, 10..50 °C	✓	✓	✓
P52	Fan operation	1 (Enabled)	0:= Disabled 1:= Enabled 2:= Only in heating 3:= Only in cooling	✓	✓	✓
P53	Fan speed	2 (3-speed)	1:= 1-speed 2:= 3-speed	✓	✓	✓
P54	Fan overrun time (only when electric heater is used)	60 sec	0 ... 300 sec	✓	✓	✓
P55	Switching point fan speed high	100%	80..100%	✓	✓	✓
P56	Switching point fan speed med	65%	30..75%	✓	✓	✓
P57	Switching point fan speed low	10%	1..15%	✓	✓	✓
P58	Fan start kick	ON	ON: enabled OFF: disabled	✓	✓	✓
P59	Fan minimum on-time	2 min	1 ... 5 min	✓	✓	✓
P60	Fan kick in Comfort mode (time to next kick)	0 (continuous)	0...89min, OFF	✓	✓	✓
P61	Fan kick in Energy Saving mode (time to next kick)	OFF	0...359min, OFF	✓	✓	✓
P62	Clean filter reminder runtime	OFF	OFF, 100 ... 9900 hours	✓	✓	✓
P65	Heating setpoint for Standby ⏻ (Wheat _{Stb})	8 °C	OFF, 5 °C...Wcool _{Stb}	✓	✓	✓
P66	Cooling setpoint for Standby ⏻ (Wcool _{Stb})	OFF	OFF, Wheat _{Stb} ...40 °C	✓	✓	✓
P69	Temporary setpoint for Comfort mode	OFF	OFF:= Disabled ON := Enable	✓	✓	✓
P70	Infrared receiver	OFF	OFF:= Disabled ON := Enable	✗	✗	✓
P71	Parameter reset Set value to ON and confirm by pressing the + and – buttons	OFF	OFF:= Idle ON: = Reset	✓	✓	✓
Diagnostic & Test						
d01	Application	Diagnose	2P:= 2-pipe 2PEL:= 2-pipe & el. heater 4P:= 4-pipe 2P3P:= 2-pipe 3pos	✓	✓	✓
d02	Status input X1	Diagnose	0:= Digital input not activated 1:= Digital input activated 0...49 °C = measured temp. value 00 := H/C input short 100:= H/C input open	✓	✓	✓
d03	Status input X2	Diagnose	Same as d02	✓	✓	✓
d05	Test mode to check the 3-position Y11/Y21 actuator direction. Note that this parameter can be quit only if the setting is back at “---” and by pressing + and – buttons	Diagnose	“---” := no signal OPE:= Y11 active →open CLO:= Y21 active →close	✓	✓	✓

4 Handling

4.1 Mounting and installation

Mount the room controller on a recessed rectangular conduit box with 60.3mm fixing centers. Do not mount on a wall in niches or bookshelves, behind curtains, above or near heat sources, or exposed to direct solar radiation. Mount about 1.5 m above the floor.

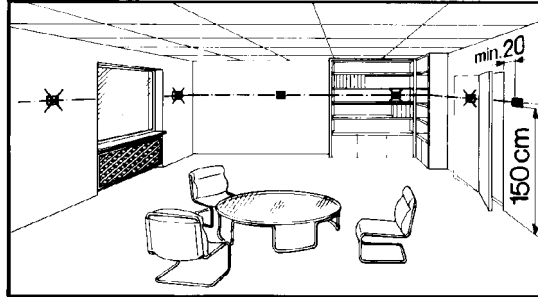

Mounting



- Devices must be mounted on clean, dry indoor place and not be exposed to dripping or splashing

Wiring



See the mounting instructions G3076 enclosed with the controller.

- Comply with local regulations to wire, fuse and earth the controller
- Properly size the cables to the controller, fan and valve actuators for AC 230 V mains voltage
- Use only valve actuators rated for AC 230 V on RDF300.../RDF400...
- The AC 230 V mains supply line must have an external fuse or circuit breaker with a rated current of no more than 10 A
- Isolate the cables of SELV inputs X1-M/X2-M if the conduit box carries AC 230 V mains voltage
- Inputs X1-M or X2-M of different units (e.g. summer/winter switch) may be connected in parallel with an external switch. Consider overall maximum contact sensing current for switch rating
- No metal conduits
- No cables provided with a metal sheath
- Disconnect from supply before opening the cover

Commissioning

Set the controller application via the DIP switches before snapping the front panel on the mounting base.

After power is applied, the controller carries out a reset during which all LCD segments flash indicating that the reset was correct. After the reset, which takes about 3 seconds, the controller is ready for commissioning by qualified HVAC staff. The control parameters of the controller can be set to ensure optimum performance of the entire system (see “Set control parameters”).

Control sequence

- The control sequence may need to be set via parameter P01 depending on the application. The factory setting for the 2-pipe application is “Cooling only”; and “Heating and Cooling” for the 4-pipe application

Compressor-based application

- When the controller is used with a compressor, the minimum output on-time (parameter P48) and off-time (parameter P49) for Y11/Y21 must be adjusted to avoid damaging the compressor and shortening its life

Calibrate sensor

- Recalibrate the temperature sensor if the room temperature displayed on the controller does not match the room temperature measured. To do this, change parameter P05

Setpoint and range limitation

- We recommend to review the setpoints and setpoint ranges (parameters P08...P12) and change them as needed to achieve maximum comfort and save energy

4.2 Operating Instructions

See the operating instructions B3076 enclosed with the controller.

4.3 Disposal



The device is classified as waste electronic equipment in terms of the European Directive 2002/96/EC (WEEE) and should not be disposed of as unsorted municipal waste.

The relevant national legal rules are to be adhered to. Regarding disposal, use the systems setup for collecting electronic waste.

Observe all local and applicable laws.

5 Engineering

5.1 Connection terminals

RDF300.../RDF400...

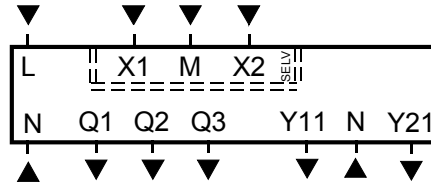

- L, N Operating voltage AC 230 V
- Q1 Control output "Fan speed 1 AC 230 V"
- Q2 Control output "Fan speed 2 AC 230 V"
- Q3 Control output "Fan speed 3 AC 230 V"
- Y11, Y21 Control output "Valve" AC 230 V (N.O., for normally closed valves), output for compressor or output for electrical heater
- X1, X2 Multifunctional input for temperature sensor (e.g. QAH11.1) or potential-free switch
- M Measuring neutral for sensor and switch

RDF340...

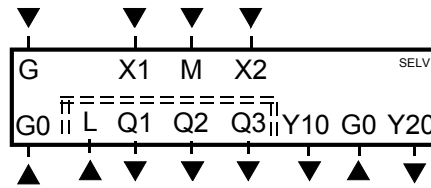

- G, G0 Operating voltage controller AC 24 V
- L Operating voltage for fan AC 230 V
- Q1 Control output "Fan speed 1 AC 230 V"
- Q2 Control output "Fan speed 2 AC 230 V"
- Q3 Control output "Fan speed 3 AC 230 V"
- Y10, Y20 Control output for 0...10 V actuator
- X1, X2 Multifunctional input for temperature sensor (e.g. QAH11.1) or switch
- M Measuring neutral for sensor and switch

5.2 Connection diagrams

5.2.1 Water-based fan coil applications with RDF300.../RDF400...

Application:

2-pipe fan coil units

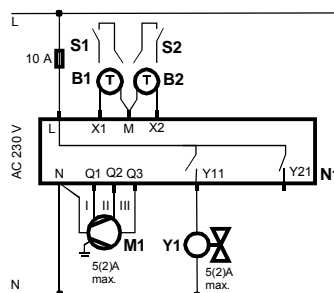

- M1 3-speed fan
- N1 Room temperature controller RDF300.../RDF400...
- Y1 Zone valve
- S1, S2 Switch (keycard, window contact, etc.)
- B1, B2 Temperature sensor (return air temperature, external room temperature, changeover sensor, etc.)

Application:

2-pipe fan coil units with electrical heater

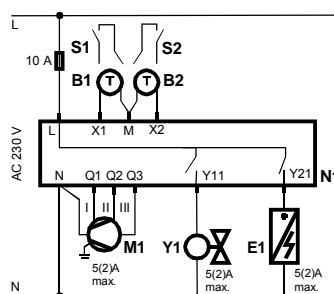

- M1 3-speed fan
- N1 Room temperature controller RDF300.../RDF400...
- Y1 Zone valve
- E1 Electrical heater
- S1, S2 Switch (keycard, window contact, etc.)
- B1, B2 Temperature sensor (return air temperature, external room temperature, changeover sensor, etc.)

Application:

4-pipe fan coil units

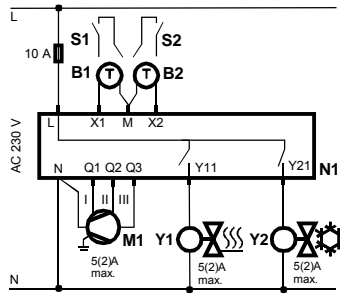

- M1 3-speed fan
- N1 Room temperature controller
RDF300.../RDF400...
- Y1 Zone valve "Heating"
- Y2 Zone valve "Cooling"
- S1, S2 Switch (keycard, window contact, etc.)
- B1, B2 Temperature sensor (return air temperature, external room temperature, changeover sensor, etc.)

Application:

2-pipe fan coil units, 3-position

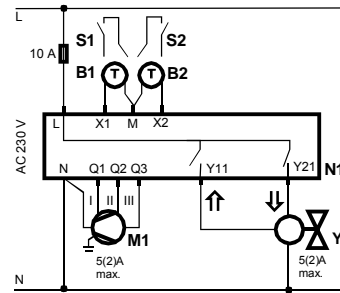

- M1 3-speed fan
- N1 Room temperature controller
RDF300.../RDF400...
- Y1 Zone valve, 3-position
- S1, S2 Switch (keycard, window contact, etc.)
- B1, B2 Temperature sensor (return air temperature, external room temperature, changeover sensor, etc.)

Application:

2-pipe fan coil units with single-speed fan

Note: Single-speed fan possible also in other applications!

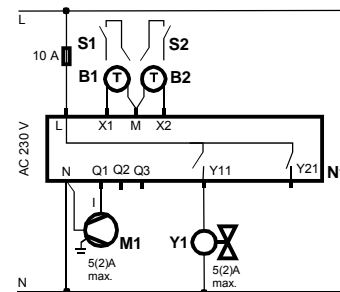

- M1 Single-speed fan
- N1 Room temperature controller
RDF300.../RDF400...
- Y1 Zone valve
- S1, S2 Switch (keycard, window contact, etc.)
- B1, B2 Temperature sensor (return air temperature, external room temperature, changeover sensor, etc.)

5.2.2 Compressor-based applications with RDF300.../RDF400...

Application:

Compressor in DX-type equipment (DIP setting: "2-pipe")

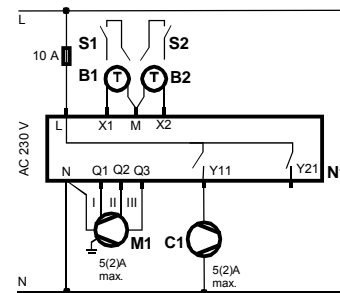

- M1 3-speed fan
- N1 Room temperature controller
RDF300.../RDF400...
- C1 Compressor
- S1, S2 Switch (keycard, window contact, etc.)
- B1, B2 Temperature sensor (return air temperature, external room temperature sensor, etc.)

Application:

Compressor in DX-type equipment with electrical heater (DIP setting: "2-pipe & el. heater")

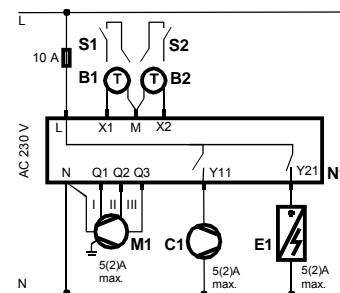

- M1 3-speed fan
- N1 Room temperature controller
RDF300.../RDF400...
- C1 Compressor
- E1 Electrical heater
- S1, S2 Switch (keycard, window contact, etc.)
- B1, B2 Temperature sensor (return air temperature, external room temperature sensor, etc.)

Application:

Compressor in DX-type equipment heating and cooling
(DIP setting: "4-pipe")

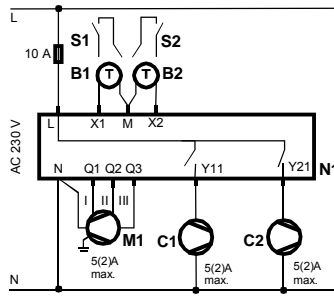

- M1 3-speed fan
- N1 Room temperature controller RDF300.../RDF400...
- C1 Compressor "Heating"
- C2 Compressor "Cooling"
- S1, S2 Switch (keycard, window contact, etc.)
- B1, B2 Temperature sensor (return air temperature, external room temperature sensor, etc.)

Note:

Use an external relay for designated reversing valve and compressor equipment terminal connections. See DX equipment wiring diagram for connection details.

5.2.3 Water-based fan coil applications with RDF340...

Application:

2-pipe fan coil units

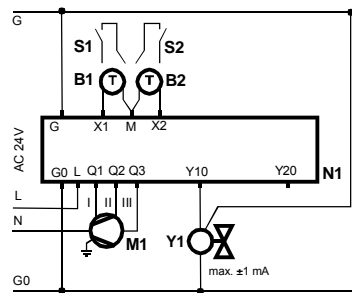

- M1 3-speed fan
- N1 Room temperature controller RDF340...
- Y1 Zone valve
- S1, S2 Switch (keycard, window contact, etc.)
- B1, B2 Temperature sensor (return air temperature, external room temperature, changeover sensor, etc.)

Application:

2-pipe fan coil units with electrical heater

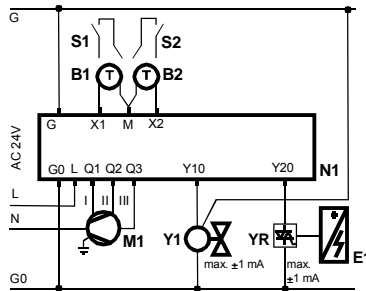

- M1 3-speed fan
- N1 Room temperature controller RDF340...
- Y1 Zone valve
- YR 0..10 signal converter/current valve
- E1 Electrical heater
- S1, S2 Switch (keycard, window contact, etc.)
- B1, B2 Temperature sensor (return air temperature, external room temperature, changeover sensor, etc.)

Application:

4-pipe fan coil units

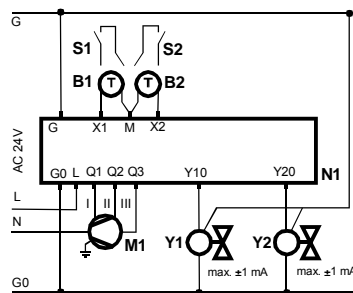

- M1 3-speed fan
- N1 Room temperature controller RDF340...
- Y1 Zone valve "Heating"
- Y2 Zone valve "Cooling"
- S1, S2 Switch (keycard, window contact, etc.)
- B1, B2 Temperature sensor (return air temperature, external room temperature, changeover sensor, etc.)

Application:

4-pipe fan coil units with single-speed fan

Note: Single-speed fan also possible in other applications!

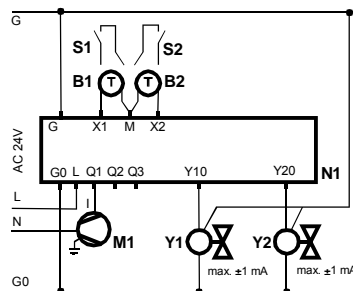

- M1 3-speed fan
- N1 Room temperature controller RDF340...
- Y1 Zone valve
- S1, S2 Switch (keycard, window contact, etc.)
- B1, B2 Temperature sensor (return air temperature, external room temperature, changeover sensor, etc.)

6 Mechanical design

The controller consists of 2 parts:

- Front panel accommodating the electronics, operating elements and built-in room temperature sensor.
- Mounting base with the power electronics.

The rear of the mounting base contains the screw terminals. The base fits on a rectangular conduit box with 60.3 mm fixing centers. Slide the front panel in the mounting base and snap on.

Operation and settings RDF300.../RDF340...



1. Operating mode selector/Standby
2. Change fan operation
3. Adjust setpoint and control parameters

RDF400...

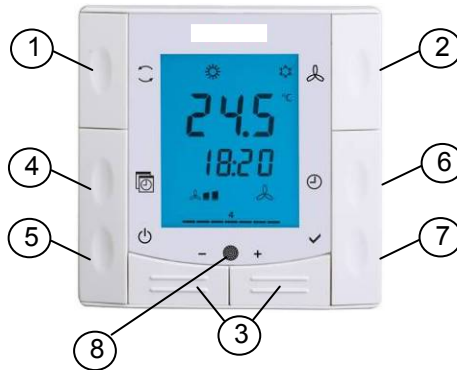

1. Change operating mode selector
2. Change fan operation
3. Adjust setpoint, control parameters and time of day
4. Auto Timer program
5. Standby
6. Set time of day and weekday
7. Confirm
8. Infrared receiver

Display

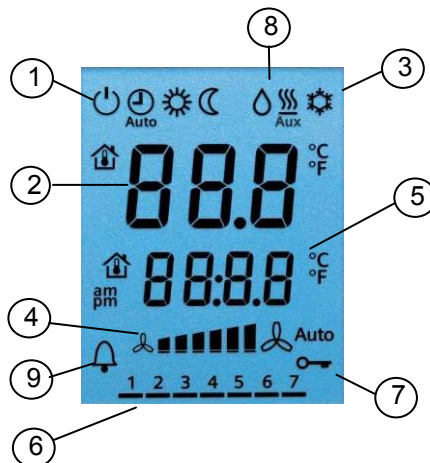

1. Operating mode
 - ⏻ Standby mode
 - 🕒 Auto Timer mode*
 - ☀️ Comfort mode
 - 🌙 Energy Saving mode

* only on RDF400...

2. Display room temperature, setpoints and control parameters.
 - 🏠 Symbol used to display the current room temperature
3. Heating/cooling mode
 - ☀️ Cooling mode
 - 🔥 Heating mode,
 - 🔥 Aux Electrical heater active
4. Fan mode
 - 🌀 Auto Auto fan active
 - 🌀 Fan speed low, medium, high
5. Additional user information (RDF3xx) or current time of day (RDF400)
6. Weekday 1..7 (1 = Monday/7 = Sunday)*
7. Keypad lock active
8. Condensation in room (dewpoint sensor active)
9. Indicate alarm or reminder

6.1 Dimensions

Dimensions in mm

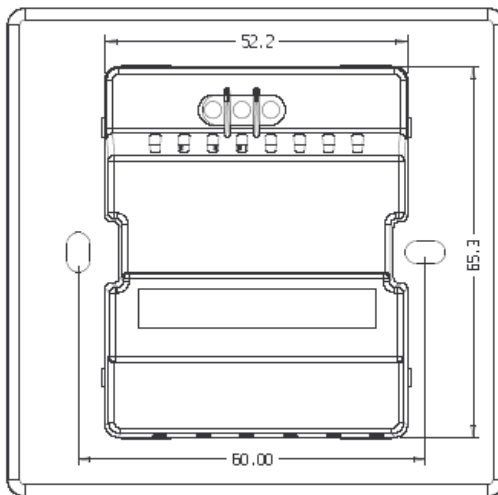
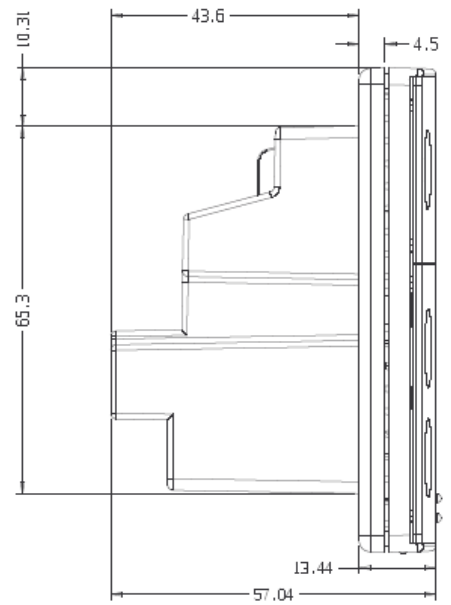
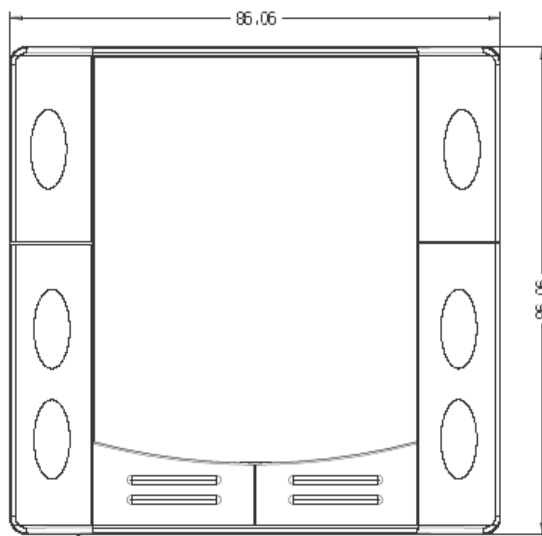

7 Technical data

⚠ Power supply

Operating voltage	AC 230 V +10/-15 %
RDF300.../RDF400... RDF340...	SELV AC 24 V ±20 %

Outputs



Frequency	50/60 Hz
Power consumption	Max. 8 VA
Fan control Q1, Q2, Q3-N	AC 230 V
Rating	Max. 5(2) A
Control output Y11-N/Y21-N (N.O.)	AC 230 V
Rating	Max. 5(2) A
Control output Y10-G0/Y20-G0	SELV DC 0...10 V
Resolution	39 mV
Current	Max. ±1 mA

Inputs

Multifunctional input X1-M/X2-M	
Temperature sensor input:	
Type	QAH11.1 (NTC)
Digital input:	
Operating action	Selectable (N.O./N.C.)
Contact sensing	SELV DC 0...5 V/max 5 mA
Insulation against mains voltage (SELV)	4 kV, reinforced insulation
Function input:	Selectable
External temperature sensor, heating/cooling changeover sensor, operating mode switchover contact, dewpoint monitor contact, enable electrical heater contact, alarm contact	

Operational data

Switching differential, adjustable	
Heating mode (P30)	2 K (0.5...6K)
Cooling mode (P31)	1 K (0.5...6K)
Setpoint setting and range	
☀ Comfort mode (P08)	21°C (5...40 °C)
☺ Energy Saving mode (P11-P12)	15°C/30°C (OFF, 5...40 °C)
⏸ Standby (P65-P66)	8°C/OFF (OFF, 5...40 °C)
Multifunctional input X1/X2	Selectable 0...6
Input X1	3: (P38) operating mode switchover
Input X2	2: (P40) heating/cooling changeover sensor
Built-in room temperature sensor	
Measuring range	0...49 °C
Accuracy at 25 °C	< ± 0.5 K
Temperature calibration range	± 3.0 K
Settings and display resolution	
Setpoints	0.5 °C
Current temperature value displayed	0.5 °C

Environmental conditions	Operation	As per IEC 721-3-3
	Climatic conditions	Class 3K5
	Temperature	0...+50 °C
	Humidity	<95 % r.h.
	Transport	As per IEC 721-3-2
	Climatic conditions	Class 2K3
	Temperature	-25...+60 °C
	Humidity	<95 % r.h.
	Mechanical conditions	Class 2M2
	Storage	As per IEC 721-3-1
Standards	Climatic conditions	Class 1K3
	Temperature	-25...+60 °C
	Humidity	<95 % r.h.
	 CE conformity	
	EMC directive	2004/108/EC
	Low-voltage directive	2006/95/EC
	 N474 C-tick conformity to	
	EMC emission standard	AS/NSZ 4251.1:1999
	 Reduction of hazardous substances	2002/95/EC
	General	Product standards
Automatic electrical controls for household and similar use		EN 60730-1
Special requirements for temperature-dependent controls		EN 60730-2-9
Electronic control type		2.B (microdisconnection on operation)
Electromagnetic compatibility		
Emissions		IEC/EN 61000-6-3
Immunity		IEC/EN 61000-6-2
Protective class		II as per EN 60730
Pollution class		Normal
Degree of protection of housing		IP 30 to EN 60529
General	Connection terminals	Solid wires or prepared stranded wires 1 x 0.4...2.5 mm ² or 2 x 0.4...1.5 mm ²
	Housing front color	RAL 9003 white, or Similar to RAL 9006 silver
	Weight	0.220 kg



● **Direct Sales Offices:**

BELGIUM AND LUXEMBOURG

☎ + 32 3 633 3045

✉ info.be@lennox europe.com

FRANCE

☎ +33 1 64 76 23 23

✉ info.fr@lennox europe.com

GERMANY

☎ + 49 69 42 09 79 0

✉ info.de@lennox europe.com

NETHERLANDS

☎ + 31 332 471 800

✉ info.nl@lennox europe.com

POLAND

☎ +48 22 58 48 610

✉ info.pl@lennox europe.com

PORTUGAL

☎ +351 229 066 050

✉ info.pt@lennox europe.com

RUSSIA

☎ +7 495 626 56 53

✉ info.ru@lennox europe.com

SLOVAKIA

☎ +421 2 58 31 83 12

✉ info.sk@lennox europe.com

SPAIN

☎ +34 91 540 18 10

✉ info.sp@lennox europe.com

UKRAINE

☎ +380 44 461 87 79

✉ info.ua@lennox europe.com

UNITED KINGDOM AND IRELAND

☎ +44 1604 669 100

✉ info.uk@lennox europe.com

● **Distributors and Agents**

Algeria, Austria, Belarus, Botswana, Bulgaria, Cyprus, Czech Republic, Denmark, Estonia, Finland, Georgia, Greece, Hungary, Israel, Italy, Kazakhstan, Latvia, Lebanon, Lithuania, Morocco, Near East, Norway, Romania, Serbia, Slovenia, Sweden, Switzerland, Tunisia, Turkey

LENNOX DISTRIBUTION

☎ +33.4.72.23.20.00

✉ info.dist@lennox europe.com



RDF300-02-AGU-0509-E

Due to Lennox's ongoing commitment to quality, the Specifications, Ratings and Dimensions are subject to change without notice and without incurring liability.

Improper installation, adjustment, alteration, service or maintenance can cause property damage or personal injury.

Installation and service must be performed by a qualified installer and servicing agency