

PRODUCT BULLETIN

Series P215LR/BR

Single/Dual Pressure Input Condenser Fan Speed Controllers For Single Phase Motors (incl. built-in RFI suppression filter)

Introduction

The P215LR is a single pressure input fan speed controller for air cooled condensers. The controller varies the fan speed by directly sensing the pressure changes in a refrigerant circuit.

The P215BR is a dual pressure input fan speed controller for air cooled condensers with dual refrigerant circuits. The controller varies the fan speed by directly sensing the pressure changes of two separate refrigerant circuits. The setpoint of each pressure transducer can be separately adjusted. The controller selects the input with the greatest cooling demand to control the fan speed.

The controllers can be used in non corrosive refrigerant systems and vary the supply voltage to the motor from 45 % to $\geq 95\%$ of the supplied voltage using the phase cutting principle. If the pressure drops below the adjusted setpoint minus the proportional band, the output to the motor is zero volt or the adjusted min. speed setting. This provides speed variation of permanent split capacitor or shaded pole motors which do not draw more than 3 A (rms) full load current.

The motor manufacturer should have approved his product for this speed control principle. It is recommended to confirm with the electric motor manufacturer, that the motor can be used with a controller, using the phase cutting principle for speed variation.



**P215LR/BR
Condenser Fan Speed Controller**

You can also provide a copy of this P215LR/BR product data sheet to the motor manufacturer/supplier for review.

Feature and Benefits

<input type="checkbox"/> Condenser pressure control by fan speed variation.	Optimum condenser pressure control all the year round. Less noise during colder (night) period.
<input type="checkbox"/> Pressure input.	Direct and fast response to pressure variations. Easy to install
<input type="checkbox"/> Model with heatpump input available	Set output to maximum if 230 V is set on the input
<input type="checkbox"/> Transducers with proven reliability.	More than half a million in use today.
<input type="checkbox"/> Easy accessible setpoint screw.	Setpoint easy adjustable. For use on various non-corrosive refrigerants.
<input type="checkbox"/> Built-in suppression filter.	The control meets the electro magnetic compatibility requirements of the 89/336/EEC directive.
<input type="checkbox"/> Adjustable minimum speed or cut-off selection.	Selection to keep the fan running on (adjusted) minimum rpm or to switch it off.
<input type="checkbox"/> Motor speed action can be reversed by interchanging only two wires.	Easy change over from direct to reverse control action
<input type="checkbox"/> Dual pressure input (BR models).	Can be used on condensers with two separate refrigerant circuits.
<input type="checkbox"/> Small dimensions.	Easy to fit in small units.
<input type="checkbox"/> DIN rail mounted	Quick to install.

Note

The P215LR/BR is intended to control equipment under normal operating conditions. Where failure or malfunction of the P215LR / BR could lead to an abnormal operating condition that could cause personal injury or damage to the equipment or other property, other devices (limit or safety controls) or systems (alarm or supervisory systems) intended to warn of or protect against failure or malfunction of the P215LR/BR must be incorporated into and maintained as part of the control system.

! Caution

Because the P215LR/BR is a single phase control, it may be used only with single-phase motors approved by the manufacturer for speed control applications.

Installation

The controller consists of a DIN-rail mounted electronic module type P38AA and one (P215LR) or two (P215BR) pressure transducer(s) type P35AC. It can be installed in any convenient location provided that the ambient conditions are suitable for the IP20 enclosure, within the specified limits regarding temperature and humidity and normal pollution situation. More motors can be wired in parallel provided that the total full load current does not exceed 3 Amp (rms). Enclosed mounting bracket(s) can be used.

Note

For style 50 and 51 pressure connections two copper sealings (one spare) are delivered with the control. Each time the pressure connection is removed this sealing has to be replaced.

Wiring (see fig. 1)

To meet the EMC directive shielded cable has to be used for motor wiring in case the distance between controller and motor is more than 2 meters. If the distance is less than 2 meters it is allowed to use non-shielded cable.

Non shielded cable may be used if the control and motor are mounted in one frame.

If the distance between the transducer(s) and the controller exceeds two metres shielded cable has to be used (The shield can be connected under the screw used to connect the transducer(s) to the mounting bracket(s)).

Both sides of the shield (motor and pressure transducer(s) wiring) have to be connected to earth. To prevent stray current, the earth connections of the transducer(s), the controller, the motor as well as the cable shield, all have to be connected to one earthing pole.

Enclosed quick connector plug(s) can be used to connect wires to the transducer(s).

! Caution

The enclosed quick connector plug(s) is especially designed (special terminal numbering) for this control and should not be used for other purposes. Take care to connect the correct wires when the original connector is replaced by a non Johnson Controls type.

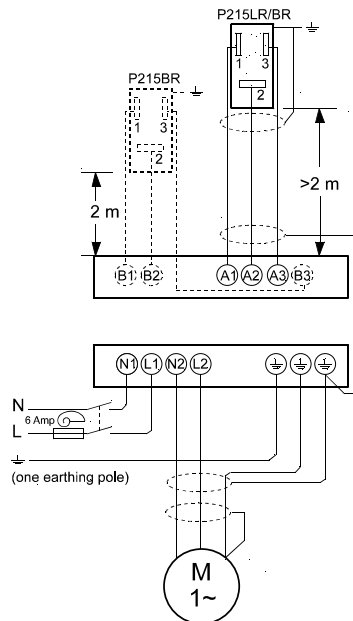

230 V Version
Fig. 1a

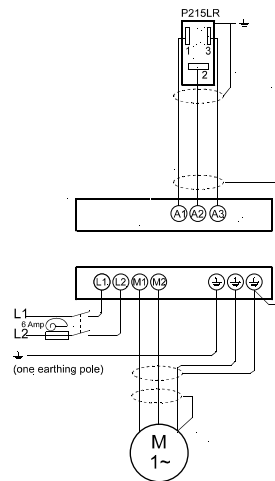

400 V Version
Fig. 1b

! Caution

There will be line voltage on the wiring between the pressure transducer(s) and the electronic module.

Control action (direct/reverse)

The wiring as shown in fig. 1 is for direct action (output voltage increases at increasing pressure). If reverse action is desired, this can be obtained by interchanging the wires at terminals 1 and 3 on the pressure transducer(s).

Heatpump model

On the heatpump model an extra input "HP" is available.

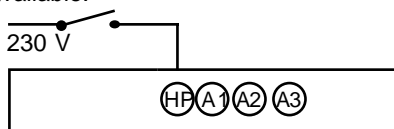

Open = cooling mode, fanspeed controlled according to condenser pressure
Close = heating mode, fanspeed to maximum

Measuring

For measuring amps or volts values a true rms meter should be used.



Caution

The P215LR/BR is not equipped with a power switch. Therefore an additional switch to isolate the device should be used in the power supply wiring to the P215LR/BR. Also the P215LR/BR should be externally fused against miswiring or short circuits (max. 6 A slow). Use a thermal/current overload relay with a current rating according to the motor.

Adjustments

The controller gives a control characteristic according to fig.2. The control characteristic can be affected by the load and the supply voltage. The proportional band is fixed and defined as the pressure difference between the points where the output values are 45% and 90% of the supply voltage.

	Range in bar		
	8 to 14	14 to 24	22 to 42
Prop. band	2.5 ± 0.5	4 ± 1	5 ± 2
Δ p (max.)	4	6	8

There is a built-in (fixed) hysteresis. This is not indicated in the control characteristic. The hysteresis is included in the prop. band.

Minimum speed setting

(230 V models only)

The minimum speed voltage setting, to prevent fan speed reduction below desirable levels, can be adjusted between 45 % and 90 % of the line voltage by means of the knob on the electronic module P38AA.

The minimum speed setting influences the proportional band. A higher setting of the minimum speed results in a smaller proportional band.

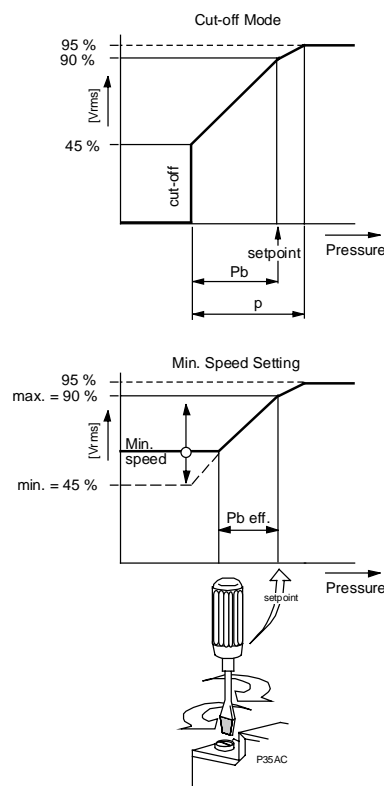

Fig.2

Cut-off mode

If minimum speed is not required, turn the knob on the electronic module to the cut-off mode. The output to the motor drops to 0 V when the pressure decreases below setpoint pressure minus proportional band. (fan stops.)

Setpoint

The pressure setpoint at which your equipment has to work can be adjusted by the range screw (see fig. 2) on the pressure transducer P35AC between 8 to 14, 14 to 24 or 22 to 42 bar.

The setpoint is factory set at:

range 8 to 14 bar	10 bar
range 14 to 24 bar	16 bar
range 22 to 42 bar	30 bar

If it is necessary to make setpoint adjustments care should be taken that the additional transducer does not affect the output voltage of the electronic module P38AA while adjustment is being made on the other transducer. The most safe and easy way to do this, is to disconnect the wiring (blue connector) of the transducer that is not being adjusted.

Repair and replacement

Repair is not possible. In case of an improperly functioning control, please check with your nearest supplier.

When contacting the supplier for a replacement you should state the type-model number of the control. This number can be found on the data plate.

Type number selection table

Order number				Replacement	
Fan speed control 230 V versions	Range (bar)	Element style	Pressure transducer	See Fig.	Electronic module
P215LR-9114	22 to 42	50	P35AC-9512	7C	P38AA-9111
P215LR-9110	14 to 24	50	P35AC-9500	7A	P38AA-9111
P215LR-9130	Bulk pack version of type P215LR-9110 (15 pcs).			7A	
P215LR-9111	8 to 14	50	P35AC-9501	7A	P38AA-9111
P215LR-9210	14 to 24	47	P35AC-9202	7B	P38AA-9111
P215LR-9211	8 to 14	47	P35AC-9203	7B	P38AA-9111
P215LR-9610	14 to 24	51	P35AC-9507	7A	P38AA-9111
P215LR-9611	8 to 14	51	P35AC-9508	7A	P38AA-9111
P215BR-9110	14 to 24	50	P35AC-9500	7A	P38AA-9211
P215BR-9111	8 to 14	50	P35AC-9501	7A	P38AA-9211
P215BR-9113	22 to 42	50	P35AC-9512	7C	P38AA-9211
P215BR-9210	14 to 24	47	P35AC-9202	7B	P38AA-9211
P215BR-9211	8 to 14	47	P35AC-9203	7B	P38AA-9211

Order number				Replacement	
230 V Heatpump versions	Range (bar)	Element style	Pressure transducer	See Fig.	Electronic module
P215LR-9140	14 to 24	50	P35AC-9500	7A	P38AA-9112

Order number				Replacement	
Fan speed control 400 V versions	Range (bar)	Element style	Pressure transducer	See Fig.	Electronic module
P215LR-9120	14 to 24	50	P35AC-9510	7A	No replacement

Note: 1 bar = 100 kPa ≈ 14.5 psi

Pressure connections

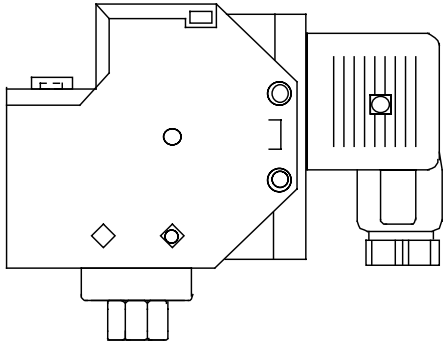

Fig. 3
Style 47 direct mount 7/16 - 20 UNF female
(incl. valve depressor)

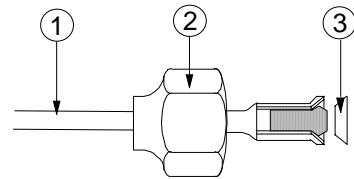

Fig. 4
Style 50 (incl. valve depressor mounted into
machined flare)

1. 90 cm capillary.
2. 7/16 - 20 UNF flare nut.
3. copper sealing

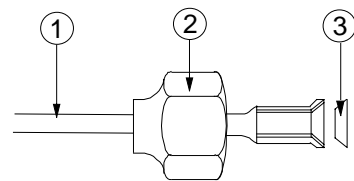

Fig. 5
Style 51 (excl. valve depressor)

Dimensions (mm)
P38AA

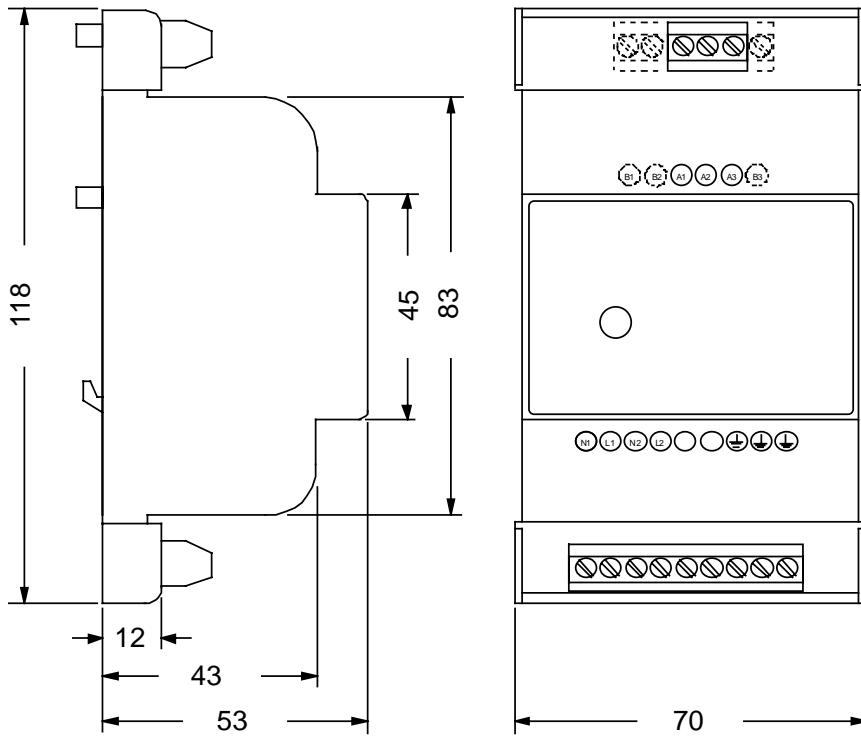

Fig. 6

P35AC

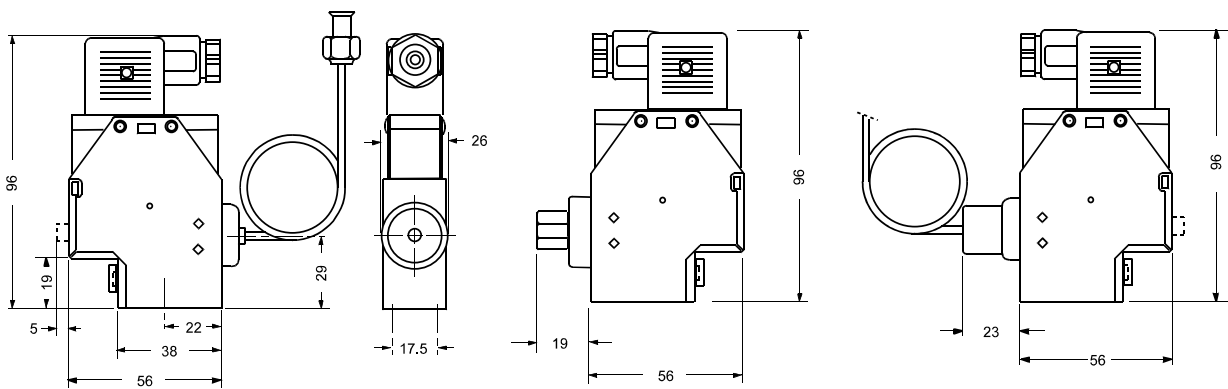

Fig. 7A

Fig. 7B

Fig. 7C

Note

Specifications

Product type	P215LR/BR		
Pressure range	22 to 42 bar 14 to 24 bar 8 to 14 bar		
Maximum overrun pressure	22 to 42 bar = 48 bar 14 to 24 bar = 40 bar 8 to 14 bar = 34 bar		
Pressure connection	style 50 with 90 cm of capillary style 51 with 90 cm of capillary style 47 (direct mount)		
Control action	direct/reverse		
Maximum output voltage	≥ 95 % of supply voltage		
Maximum current	3 A rms (at maximum voltage output)		
Minimum current	≥ 100 mA		
Power factor (cosφ) motor	≥ 0.6		
Mains supply voltage	230 Vac +10 % / -15 % 400 Vac +10 % / -15 %		
Mains supply frequency	50/60 Hz		
Operating ambient temperature	-20 to +55° C		
Operating /storage ambient humidity.	10 to 98 % R.H. (non-condensing)		
Storage ambient Temp.	-40 to 85 °C		
Min. speed	adjustable from 45 to ≥90 % of supply voltage		
Cut-off point	45 % of supply voltage		
Prop. band range	22 to 42 bar =	5 ± 2 bar	
range	14 to 24 bar =	4 ± 1 bar	
range	8 to 14 bar =	2.5 ± 0.5 bar	at the minimum speed adjustment of 45% of line voltage
Enclosure electronic module	IP20		
pressure transducer	IP20		
Material	enclosure ABS/PC mixture		
Shipping weight	P215LR	individual pack	0.56 kg
		overpack	15 kg (24 pcs.)
		bulkpack	8 kg (15 pcs.)
	P215BR	individual pack	0.85 kg
Residual current motor	in cut-off mode ≤ 15 mA		
Wiring connections	P35AC	screw terminals 1 mm ² up to 1½ mm ²	
	P38AA	screw terminals 1 mm ² up to 2½ mm ²	
Mounting	DIN rail 35 mm.		

The performance specifications are nominal and conform to acceptable industry standards. For applications at conditions beyond these specifications, consult the local Johnson Controls office or representative. Johnson Controls shall not be liable for damages resulting from misapplication or misuse of its products.

**Johnson Controls International, Inc.**

Headquarters: Milwaukee, WI, USA
 European Headquarters: Brussels, Belgium
 European Factories: Lomagna (Italy), Leeuwarden (The Netherlands) and Essen (Germany)
 Branch Offices: Principal European Cities.

This document is subject to change

www.johnsoncontrols.com

Printed in Europe