

0 5 10 15 20 25 30 35 40 45 50 55 60 65 70 75 80 85 90 95

INDICE	
REGLETERO CONEXIONES ELECTRICAS TERMINAL STRIP BORNIER DE CONNEXION ELECTRIQUE KLEMMLEISTE	HOJA 1/5
CIRCUITO POTENCIA POWER CIRCUIT CIRCUIT DE PUISSANCE STROMKREIS	HOJA 2/5
CIRCUITO MANIOBRA CONTROL CIRCUIT CIRCUIT DE CONTROL STUEERKREIS	HOJA 3/5
CONEXION OPCIONALES OPTIONS CONNEXIONS OPTIONNELS OPTIONEN / ZUBEHÖR	HOJA 4/5
LEYENDA REFERENCIAS REFERENCES LEGEND REFERENCE DE LEGENDE LEGENDE	HOJA 5/5

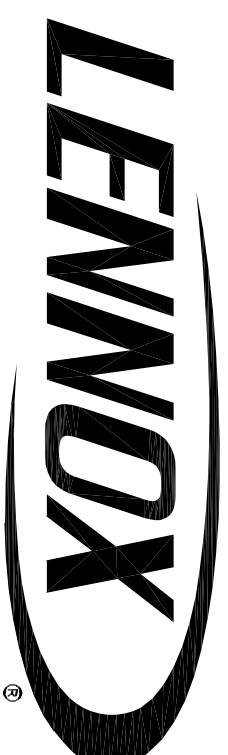

ESQUEMA ELECTRICO  
WIRING DIAGRAM  
SCHEMA ELECTRIQUE  
SCHALTPLAN

Elemento Opcional  
Optional Element  
Element optionnel  
Optionales bauteil

A realizar por el instalador  
To wire by the installer  
A câbler par l'installateur  
Verdrahtung durch den installateur

<b>5</b>	Lennox Refrac S.A.	ESQUEMA ELECTRICO ELECTRIC DIAGRAM	<b>KSCM 22E</b>	4Z-33-410-117 10J 3N ~ 400V 50Hz + PE
----------	--------------------	---------------------------------------	-----------------	--

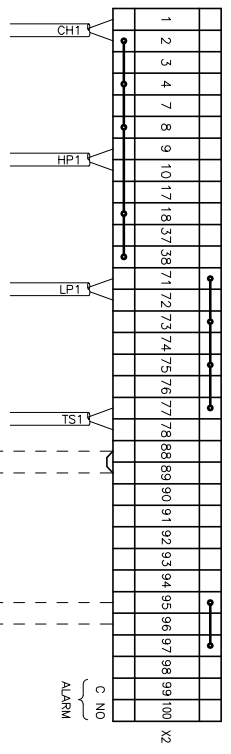
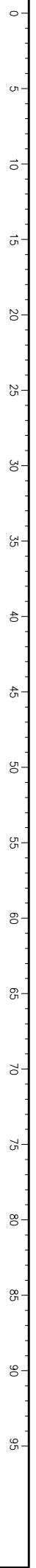

ON/OFF REMOTE ON/OFF  
 REMOTO ON/OFF

ETAPA 1  
 STAGE 1

Elemento Opcional  
 Optional Element  
 Element optionnel  
 Optionales bauteil

A realizar por el instalador  
 To wire by the installer  
 A câbler par l'installateur  
 Verdrahtung durch den Installateur

**⚠** RETIRAR PUNTE SI SE MONTA ON/OFF REMOTO  
 REMOVE LINK FOR REMOTE ON/OFF OPERATION  
 RETIRER LE PONT EN CAS DE MARCHÉ/ARRÊT A DISTANCE  
 ENTFERNE DIE VERBINDUNG ZUM EIN/AUS FERNSCHALTER

**⚠** ESTAS BORNAS SOLAMENTE SE INCLUYEN CON SU OPCIONAL  
 THESE TERMINALS ARE ONLY INCLUDED WITH ITS OPTIONAL  
 CES CONTACTS SONT INSTALLEES SEULEMENT SI ON DEMANDE CHOISIT L'OPTIONAL  
 DESE ANSCHLUSSKLEMMEN SIND NUR MIT ZUBEHÖR VERFÜGBAR IHREM OPTIONAL

VER MANUAL INSTALACION  
 SEE INSTALLATION MANUAL (IOM)  
 VOIR LE MANUEL D'INSTALLATION  
 SIEHE INSTALLATIONSHANDBUCH (IOM)

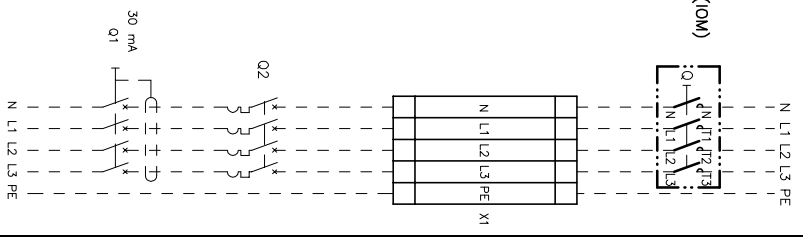

ALIMENTACION  
 POWER SUPPLY  
 ALIMENTATION ELECTRIQUE  
 STROMZULEITUNG

3N~400V 50Hz+PE

<b>1/5</b>	Lemnox Refrac S.A.	ESQUEMA ELECTRICICO ELECTRIC DIAGRAM	<b>KSCM 22E</b>	4Z-33-410-117 10J 3N ~ 400V 50Hz + PE
------------	--------------------	---	-----------------	--

0 5 10 15 20 25 30 35 40 45 50 55 60 65 70 75 80 85 90 95

3N~400V 50Hz+PE  
 N L1 L2 L3 PE  
 VER MANUAL INSTALACION  
 SEE INSTALLATION MANUAL (OM)  
 VOIR LE MANUEL D'INSTALLATION  
 SIEHE INSTALLATIONSHANDBUCH (OM)

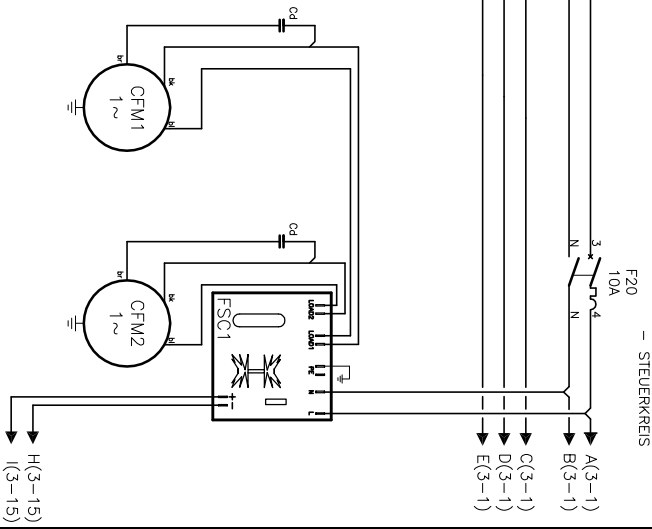
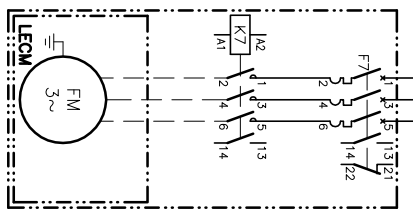
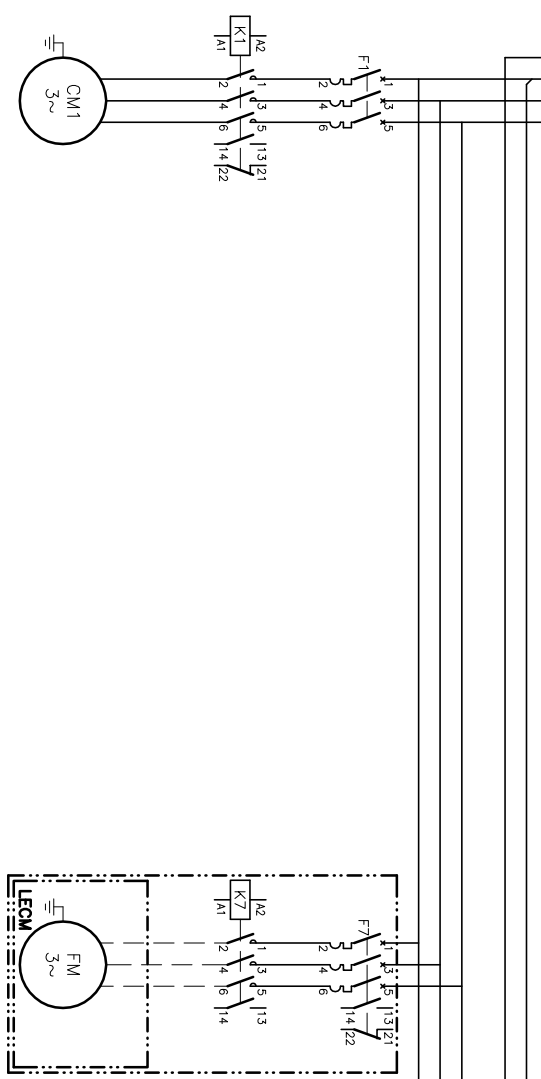
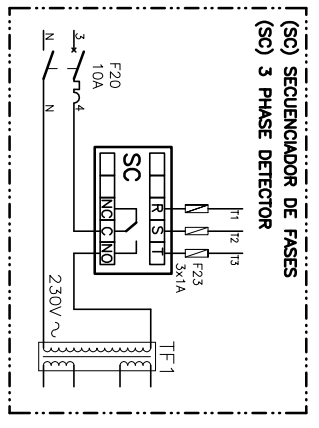
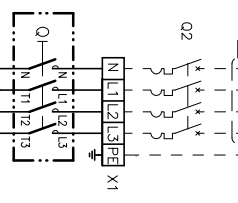

Int(CC)	15A	2,59A	0,8A	0,8A
KSCM [q(LRA)]	101A	13A	2,4A	2,4A
ZZE F	20A	2,5, 4A		2,4A

Elemento Opcional  
 Optional Element  
 Element optionnel  
 Optionales bauteil

A realizar por el instalador  
 To wire by the installer  
 A câbler par l'installateur  
 Verdrahtung durch den Installateur

**2/5** Lennox Refrac S.A. ESQUEMA ELECTRICO ELECTRIC DIAGRAM **KSCM 22E** 4Z-33-410-117 10U 3N ~ 400V 50Hz + PE

0 5 10 15 20 25 30 35 40 45 50 55 60 65 70 75 80 85 90 95

RETIRAR PUENTE CON OPCIONAL  
REMOVE LINK WITH OPTIONAL

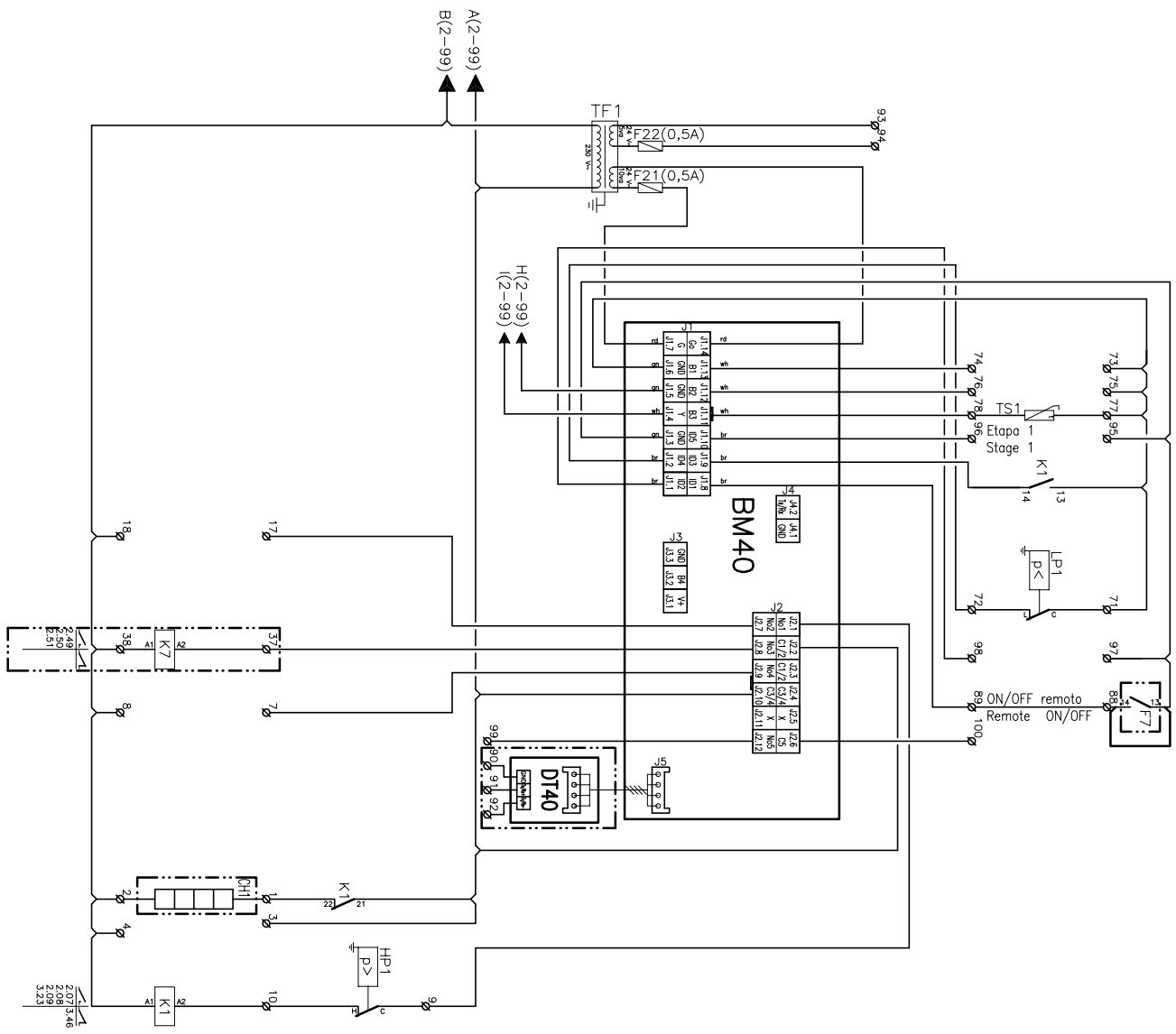

Elemento Opcional  
Optional Element  
Element optionel  
Optionales bauteil

A realizar por el instalador  
To wire by the installer  
A cobler por l'installateur  
Verdrahtung durch den installateur

3/5  
Lemnox Retrac S.A.

ESQUEMA ELECTRICO  
ELECTRIC DIAGRAM

KSCM 22E

4Z-33-410-117 10J  
3N ~ 400V 50Hz + PE

0 5 10 15 20 25 30 35 40 45 50 55 60 65 70 75 80 85 90 95

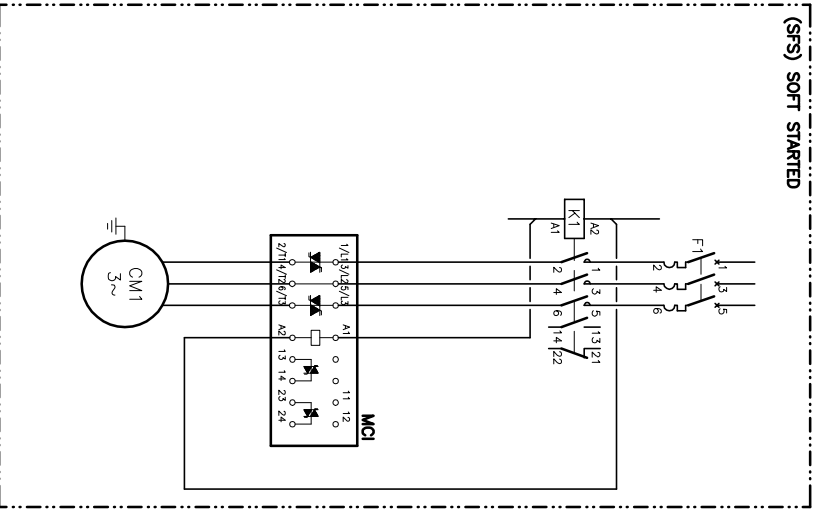

(SFS) SOFT STARTED

Elemento Opcional  
Optional Element  
Element optionnel  
Optionales bauteil

A realitzar por el instalador  
To wire by the installer  
A câbler par l'installateur  
Verdrahtung durch den installateur

4/5	Lemnox Refrac S.A.	ESQUEMA ELECTRICO ELECTRIC DIAGRAM	KSCM 22E	4Z-33-410-117 10J 3N ~ 400V 50Hz + PE
-----	--------------------	---------------------------------------	----------	--

0	5	10	15	20	25	30	35	40	45	50	55	60	65	70	75	80	85	90	95
BM40 C4 CH CFM CM DT40 F1-7 F20 F21-22-23 F31-34 F35-36 FM FSC HPR1-2 HPR1-1-2 Iq(LRA) Im(MCC) K LP1-2 P11-2 Q Q1 O2 R1-20 SC SFS TF1-2 TS1-2	LEYENDA	Modulo logico Condensador Resistencia de carter Motor ventilador exterior Motor compresor Modulo TTL-485 Magnetotérmico Magnetotérmico Fusible del TF1-SC Modulo protección compresor Protección térmica Motor ventilador interior Control de condensación Presostato de alta Presostato CPC Intensidad de arranque Intensidad máxima Contactor Presostato baja Transductor de presión refrigerante Interruptor general Interruptor diferencial Interruptor magnetotérmico Relé auxiliar Relé control de secuencia-fallo de fases Arrancador suave Transformador Sonda temperatura condensacion	LEGEND	Logic Module Capacitor Crankcase heater Compressor fan motor Compressor motor TTL-485 Module Circuitbreaker Circuitbreaker TF1-SC fuse Compressor protector module Thermal protection Indoor fan motor Fan speed control High pressure pressostat CPC pressure switch Starting current Maximum current Contactor Low pressure pressostat Refrigerant pressure transducer Main switch Ground safety switch Circuit breaker Auxiliary relay Phase sequence and failure control relay Soft starter Transformer Condensing temperature sensor	REFERENCE	Modulo de Control Condensateur Résistance de carter Moteur ventilateur extérieur Compresseur Module de TTL-485 Disjoncteur Disjoncteur Fusible TF1-SC Module protection du compresseur Protection thermique Moteur ventilateur intérieur Vordrueur de vitesse du ventilateur Pressostat HP Pressostat du control de pression condensation Intensité de démarrage Intensité maximale Contacteur Pressostat BP Transducteur de pression Interrupteur général Interrupteur différentiel Interrupteur magneto thermique Relais auxiliaire Décteur de phases Démarrreur progressif Transformateur Sonde temp. condensation	LEGENDE	Logic Modul Kondensator Kurbelwärmehheizung Kondensatorlüftermotor Kompressor TTL-485 Modul MotorSchutzSchalter MotorSchutzSchalter TF1-SC Schutz Therm. Kompressorrelais Therm. Relais Innenventilatormotor Kondensationsdruckregelung Hochdruckpressostat Kondensationsdruckregelungpressostat Anlaufstrom Maximale stromstärke Schütz Niederdruckpressostat Drucktransmitter HauptSchalter Schalter MotorSchutzSchalter Hilfsrelais Phasenfolgenüberwachung+Störemel Softstarter/Sanftanlauf Transformator Temperaturfühler Kondensator											
bk br rd or yl gn bl vi gr wh	CODIGO DE COLORES	negro marrón rojo naranja amarillo verde azul violeta gris blanco	COLOUR CODE	black brown red orange yellow green blue violet gray white	CODE COULEUR	noir brun rouge orange jaune vert bleu violet gris blanc	FARBKENNUNG	schwarz braun rot orange gelb grün blau violett grau weiss											

5/5

Lemnox Refrac S.A.

ESQUEMA ELECTRICO  
ELECTRIC DIAGRAM

KSCM 22E

4Z-33-410-117 10J  
3N ~ 400V 50Hz + PE