

0 5 10 15 20 25 30 35 40 45 50 55 60 65 70 75 80 85 90 95

INDICE	
REGLETERO CONEXIONES ELECTRICAS TERMINAL STRIP BORNIER DE CONNEXION ELECTRIQUE KLEMMLEISTE	HOJA 1/5
CIRCUITO POTENCIA POWER CIRCUIT CIRCUIT DE PUISSANCE STROMKREIS	HOJA 2/5
CIRCUITO MANIOBRA CONTROL CIRCUIT CIRCUIT DE CONTROL STUEERKREIS	HOJA 3/5
CONEXION OPCIONALES OPTIONS CONNEXIONS OPTIONNELS OPTIONEN / ZUBEHÖR	HOJA 4/5
LEYENDA REFERENCIAS REFERENCES LEGEND REFERENCE DE LEGENDE LEGENDE	HOJA 5/5



ESQUEMA ELECTRICICO
WIRING DIAGRAM
SCHEMA ELECTRIQUE
SCHALTPLAN

Elemento Opcional
Optional Element
Element optionnel
Optionales bauteil

A realizar por el instalador
To wire by the installer
A câbler par l'installateur
Verdrahtung durch den installateur

%	Lennox Refrac S.A.	ESQUEMA ELECTRICICO ELECTRIC DIAGRAM	KSCM 22E + KIT -15°C	4Z-33-410-118 10J 3N ~ 400V 50Hz + PE
----------	--------------------	---	-----------------------------	--

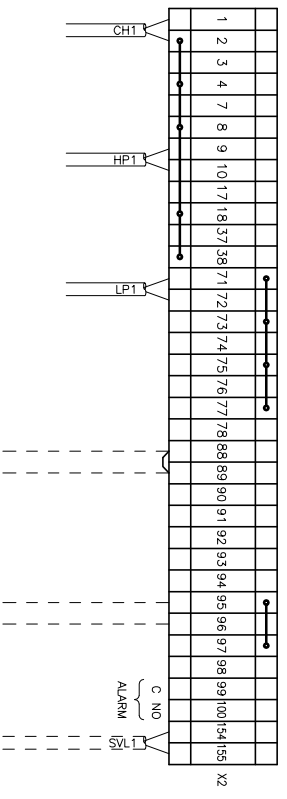
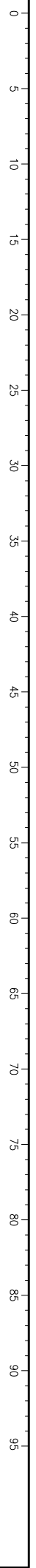

ON/OFF REMOTE ON/OFF

ETAPA 1
STAGE 1

⚠ RETIRAR PUNTE SI SE MONTA ON/OFF REMOTO
 REMOVE LINK FOR REMOTE ON/OFF OPERATION
 RETIRER LE PONT EN CAS DE MARCHÉ/ARRÊT A DISTANCE
 ENTFERNE DIE VERBINDUNG ZUM EIN/AUS FERNSCHALTER

⚠ ESTAS BORNAS SOLAMENTE SE INCLUYEN CON SU OPCIONAL
 THESE TERMINALS ARE ONLY INCLUDED WITH ITS OPTIONAL
 CES CONTACTS SONT INSTALLEES SEULEMENT SI ON DEMANDE CHOISIT L'OPTIONAL
 DESE ANSCHLUSSKLEMMEN SIND NUR MIT ZUBEHÖR VERFÜGBAR IHREM OPTIONAL

VER MANUAL INSTALACION
 SEE INSTALLATION MANUAL (IOM)
 VOIR LE MANUEL D'INSTALLATION
 SIEHE INSTALLATIONSHANDBUCH (IOM)

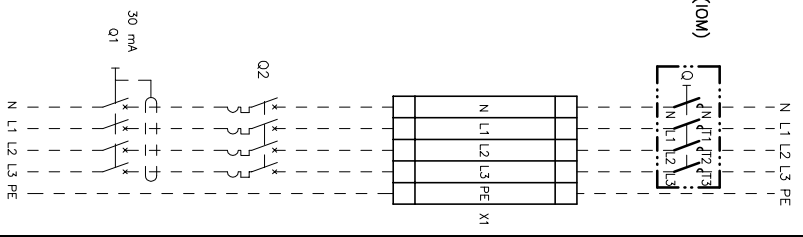

Elemento Opcional
 Optional Element
 Element optionnel
 Optionales bauteil

A realizar por el instalador
 To wire by the installer
 A câbler par l'installateur
 Verdrahtung durch den installateur

1/5

Lemnox Refrac S.A.

ESQUEMA ELECTRICO
 ELECTRIC DIAGRAM

KSCM 22E + KIT -15°C

4Z-33-410-118 10J
 3N ~ 400V 50Hz + PE
 3N~400V 50Hz+PE

ALIMENTACION
 POWER SUPPLY
 ALIMENTATION
 STROMZULEITUNG

0 5 10 15 20 25 30 35 40 45 50 55 60 65 70 75 80 85 90 95

3N~400V 50Hz+PE
 N L1 L2 L3 PE
 VER MANUAL INSTALACION
 SEE INSTALLATION MANUAL (OM)
 VOIR LE MANUEL D'INSTALLATION
 SIEHE INSTALLATIONSHANDBUCH (OM)

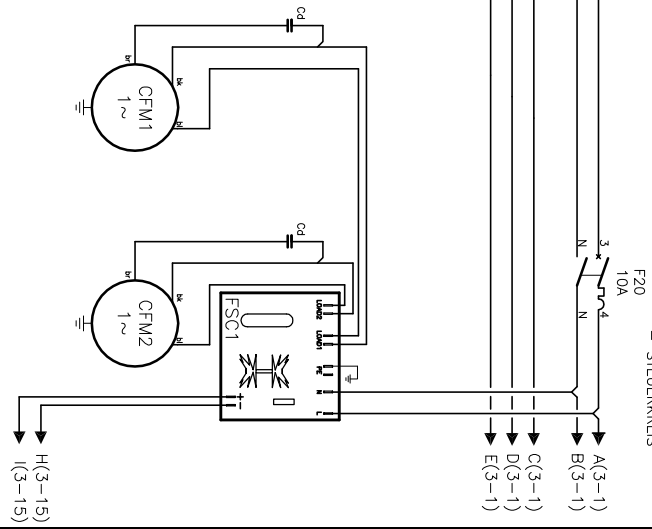
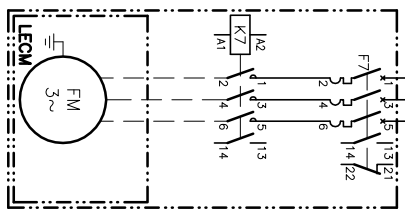
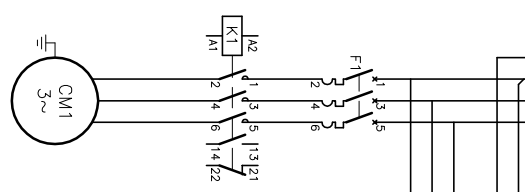
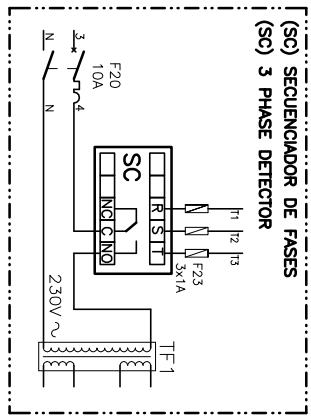
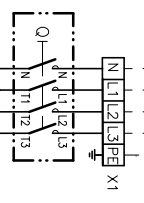

Int(CC)	15A	2,59A	0,8A	0,8A
KSCM	101A	13A	2,4A	2,4A
g(LRA)	20A	2,5,4A		
ZZE	F			

Elemento Opcional
 Optional Element
 Element optionnel
 Optionales bauteil

A realizar por el instalador
 To wire by the installer
 A câbler par l'installateur
 Verdrahtung durch den Installateur

2/5
 Lemnox Refrac S.A.

ESQUEMA ELECTRICO
 ELECTRIC DIAGRAM

KSCM 22E + KIT -15°C

4Z-33-410-118 10U
 3N ~ 400V 50Hz + PE

0 5 10 15 20 25 30 35 40 45 50 55 60 65 70 75 80 85 90 95

RETIRAR PUENTE CON OPCIONAL
REMOVE LINK WITH OPTIONAL

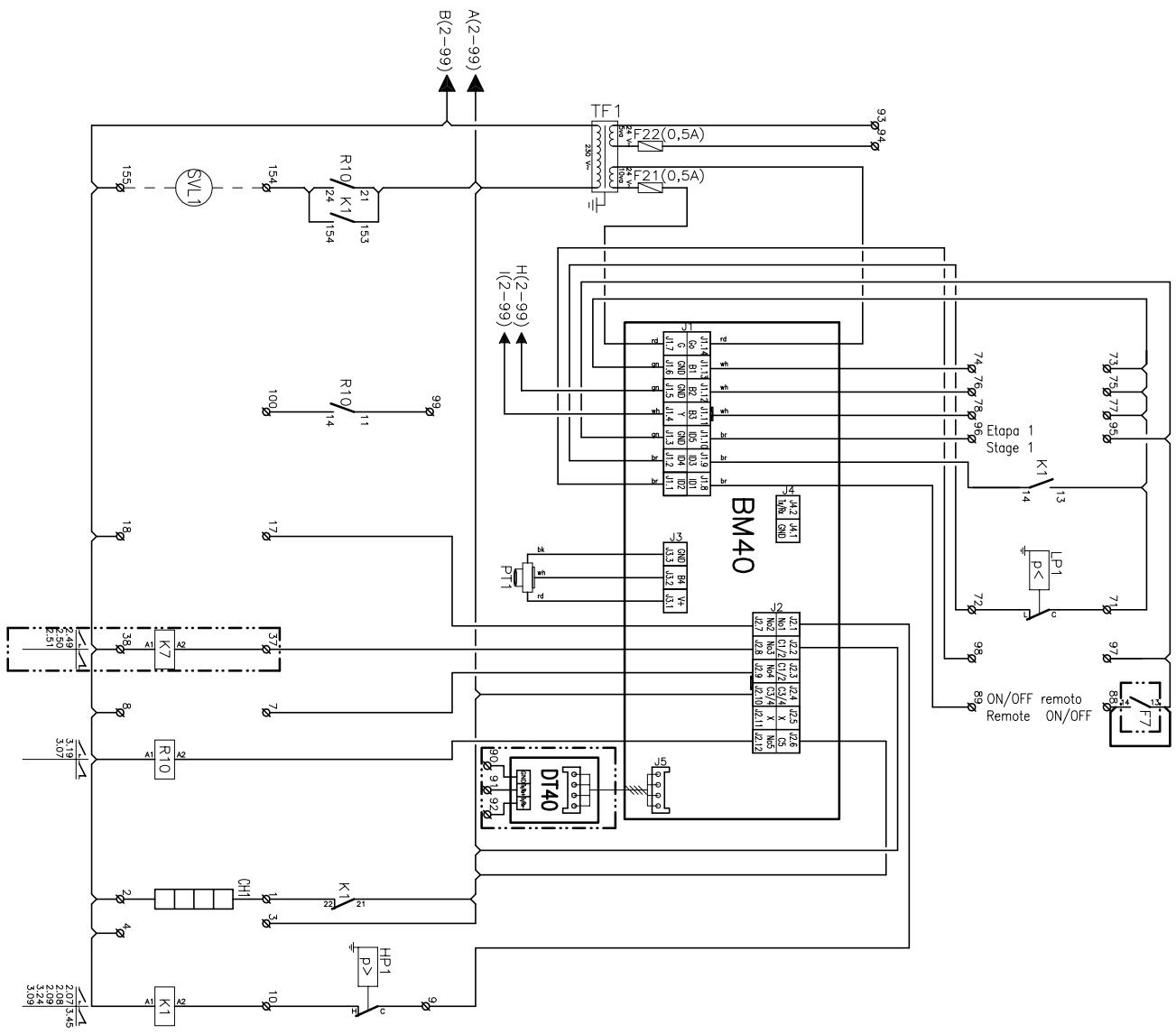

Elemento Opcional
Optional Element
Element optionnel
Optionales bauteil

A realizar por el instalador
To wire by the installer
A câbler par l'installateur
Verdrahtung durch den installateur

3/5	Lemnox Retrac S.A.	ESQUEMA ELECTRICO ELECTRIC DIAGRAM	KSCM 22E + KIT -15°C	4Z-33-410-118 10J 3N ~ 400V 50Hz + PE
------------	--------------------	---------------------------------------	-----------------------------	--

0 5 10 15 20 25 30 35 40 45 50 55 60 65 70 75 80 85 90 95

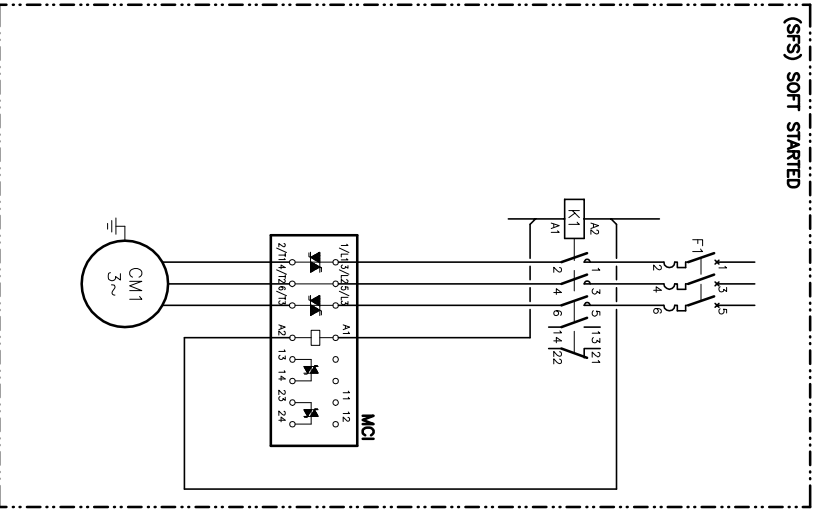

Elemento Opcional
 Optional Element
 Element optionnel
 Optionales bauteil

A realizar por el instalador
 To wire by the installer
 A câbler par l'installateur
 Verdrahtung durch den installateur

4/5

Lemnox Refrac S.A.

ESQUEMA ELECTRICO
 ELECTRIC DIAGRAM

KSCM 22E + KIT -15°C

4Z-33-410-118 10J
 3N ~ 400V 50Hz + PE

0	5	10	15	20	25	30	35	40	45	50	55	60	65	70	75	80	85	90	95
BM40 C4 CH CHM CM DT40 F1-7 F20 F21-22-23 F31-34 F35-36 FM FSC HPR1-2 HPR1-1-2 Iq(LRA) Iq(MCC) K LP1-2 P11-2 Q Q1 R1 R1-20 SC SFS SVL1-2 TF1-2 TS1-2	LEYENDA	Modulo logico Condensador Resistencia de carter Motor ventilador exterior Motor compresor Modulo TTL-485 Magnetotérmico Magnetotérmico Fusible del TF1-SC Modulo protección compresor Protección térmica Motor ventilador interior Control de condensación Presostato de alta Presostato CPC Intensidad de arranque Intensidad máxima Contactor Presostato baja Transductor de presión refrigerante Interruptor general Interruptor diferencial Interruptor magnetotérmico Relé auxiliar Relé control de secuencia-fallo de fases Arrancador suave Válvula solenoide líquido Transformador Sonda temperatura condensacion	LEGEND	Logic Module Capacitor Crankcase heater Compressor fan motor Compressor TTL-485 Module Circuitbreaker Circuitbreaker TF1-SC fuse Compressor protector module Thermal protection Indoor fan motor Fan speed control High pressure pressostat CPC pressure switch Starting current Maximum current Contactor Low pressure pressostat Refrigerant pressure transducer Main switch Ground safety switch Circuit breaker Auxiliary relay Phase sequence and failure control relay Soft starter Liquid Solenoid Valve Transformer Condensing temperature sensor	REFERENCE	Modulo de Control Condensateur Résistance de carter Moteur ventilateur extérieur Compresseur Module de TTL-485 Disjoncteur Disjoncteur Fusible TF1-SC Module protection du compresseur Protection thermique Moteur ventilateur intérieur Vandeur de vitesse du ventilateur Pressostat HP Pressostat du control de pression condensation Intensité de démarrage Intensité maximale Contacteur Pressostat BP Transducteur de pression Interrupteur général Interrupteur différentiel Interrupteur magneto thermique Relais auxiliaire Détekteur de phases Démarréur progressif Válve Solénoide liquide Transformateur Sonde temp. condensation	LEGENDE	Logic Modul Kondensator Kurbelwärmehheizung Kondensatorlüftermotor Kompressor TTL-485 Modul MotorSchutzSchalter MotorSchutzSchalter TF1-SC Schutz Therm. Kompressorrelais Therm. Relais Innenventilatormotor Kondensationsdruckregelung Hochdruckpressostat Kondensationsdruckregelungpressostat Anlaufstrom Maximale stromstärke Schütz Niederdruckpressostat Drucktransmitter HauptSchalter Schalter MotorSchutzSchalter Hilfsrelais Phasenfolgenüberwachung+Störmel Softstarter/Sartianlauf Magnetspule Flüssigkeitleitung Transformator Temperaturfühler Kondensator											
bk br rd or yl gn bl vi gr wh	CODIGO DE COLORES	negro marrón rojo naranja amarillo verde azul violeta gris blanco	COLOUR CODE	black brown red orange yellow green blue violet gray white	CODE COLEUR	noir brun rouge orange jaune vert bleu violet gris blanc	FARBKENNUNG	schwarz braun rot orange gelb grün blau violett grau weiss											

5/5

Lemnox Refrac S.A.

ESQUEMA ELECTRICO
ELECTRIC DIAGRAM

KSCM 22E + KIT -15°C

4Z-33-410-118 10J
3N ~ 400V 50Hz + PE