



Serie	NQ/AD/U/XR
Model	130

Drawing code	HF620C0750	Controller	PC01
--------------	------------	------------	------

Power supply	400V/3~/50Hz +N	-
Auxiliary supply	24VAC	-

Created by	N.C.1	Revision by	N.C.1	Index	C
Date	07/09/2007	On	25/10/2008		

Max power (kW)	SEE TABLE ON PAGE 2
FLA (A)	SEE TABLE ON PAGE 2
RLA (A)	SEE TABLE ON PAGE 2

Main protection	SEE TABLE ON PAGE 2
-----------------	---------------------

1	2		3		4	5	6		7		8		
MODEL	POWER SUPPLY	MAX ABSORBED POWER (kW)	MAX ABSORBED CURENT (A)	RLA (A)	MAIN SUGGEST PROTECTION gG FUSE TYPE	MIN SUGGEST CROSS SECTION LINE (mm ²) VS MAX LENGTH (m) AIR TEMPERATURE 30°C – MULTICORE CABLE – CABLE INSIDE TUBE ON AIR							
						PVC ISULATED			EPR (G7-G10) ISULATED				
						CABLE WORKING TEMPERATURE 70°C	MAX LENGTH VOLTAGE DROP<4%	CABLE WORKING TEMPERATURE 90°C	MAX LENGTH VOLTAGE DROP<4%				
130	LINE	12	33	70	50	10	150	6	90				
A	REVISIONE GENERALE	10/07/2008	N.C.1	DATE	07/09/2007					SHEET 2 OF 30			
B	REVISIONE GENERALE	10/09/2008	N.C.1	DRAW.	N.C.1					HF620C0750		CONTINUE 3	
C	REVISIONE GENERALE	25/10/2008	N.C.1	CHECK	F.F.1								
REV.	MODIFICATIONS	DATE	SIGN.	APPR.	M.M.								

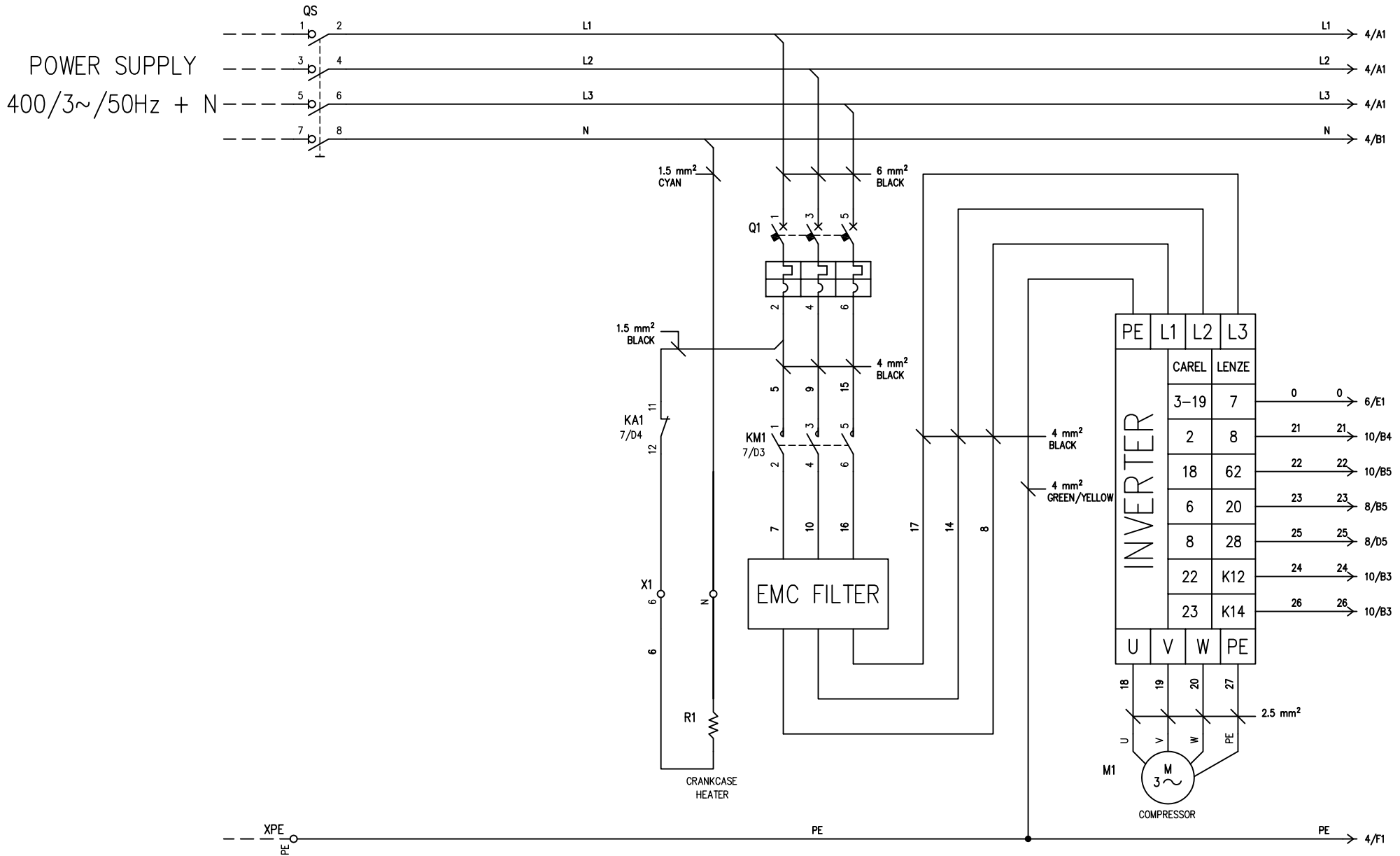

A	REVISIONE GENERALE	10/07/2008	N.C.1	DATE	07/09/2007
B	REVISIONE GENERALE	10/09/2008	N.C.1	DRAW.	N.C.1
C	REVISIONE GENERALE	25/10/2008	N.C.1	CHECK	F.F.1
REV.	MODIFICATIONS	DATE	SIGN.	APPR.	M.M.



HF620C0750

SHEET 3 OF 30
CONTINUE 4

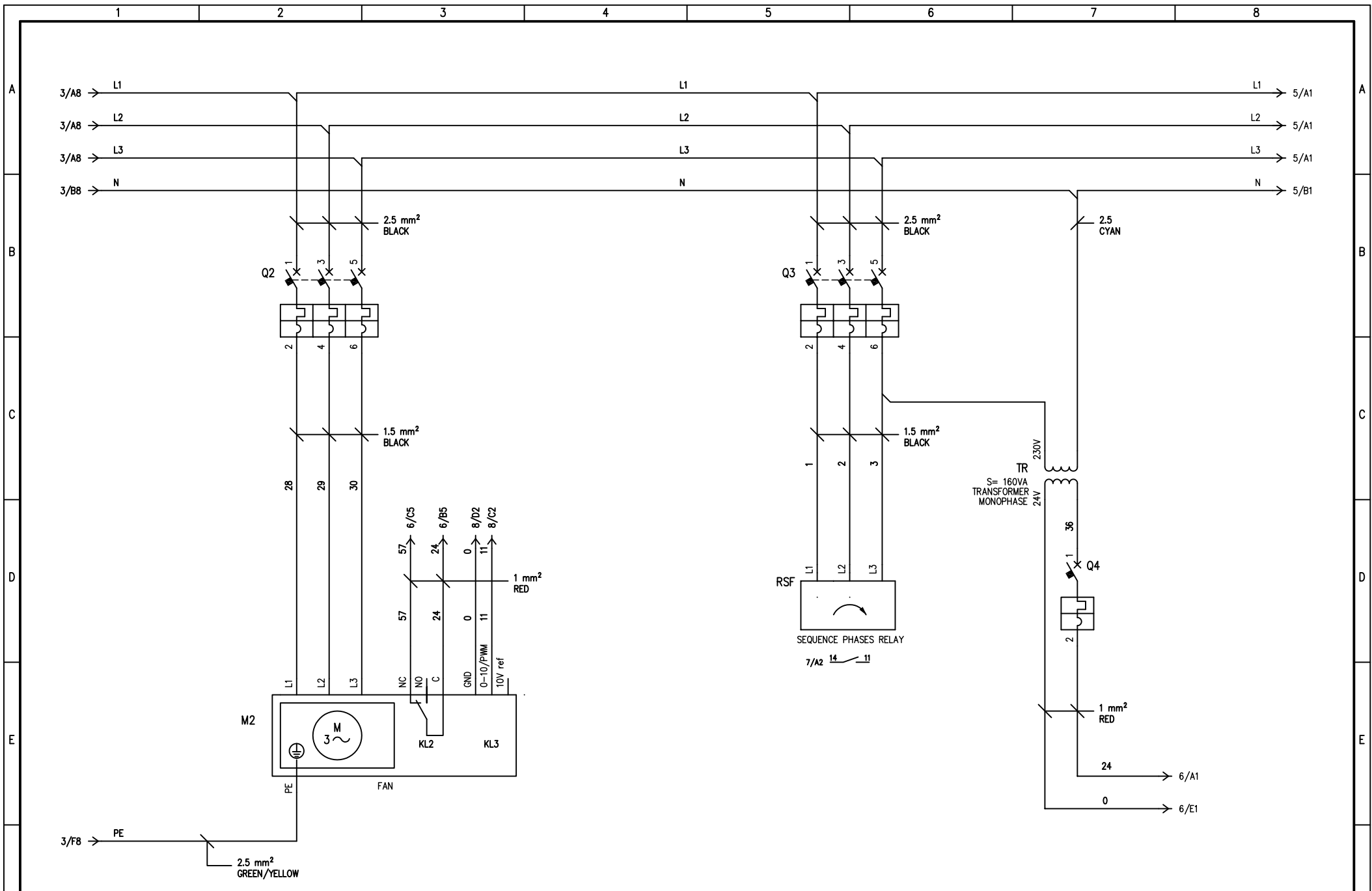

A	REVISIONE GENERALE	10/07/2008	N.C.1	DATE	07/09/2007		HF620C0750	SHEET	4 OF 30
B	REVISIONE GENERALE	10/09/2008	N.C.1	DRAW.	N.C.1			CONTINUE	5
C	REVISIONE GENERALE	25/10/2008	N.C.1	CHECK	F.F.1				
REV.	MODIFICATIONS	DATE	SIGN.	APPR.	M.M.				

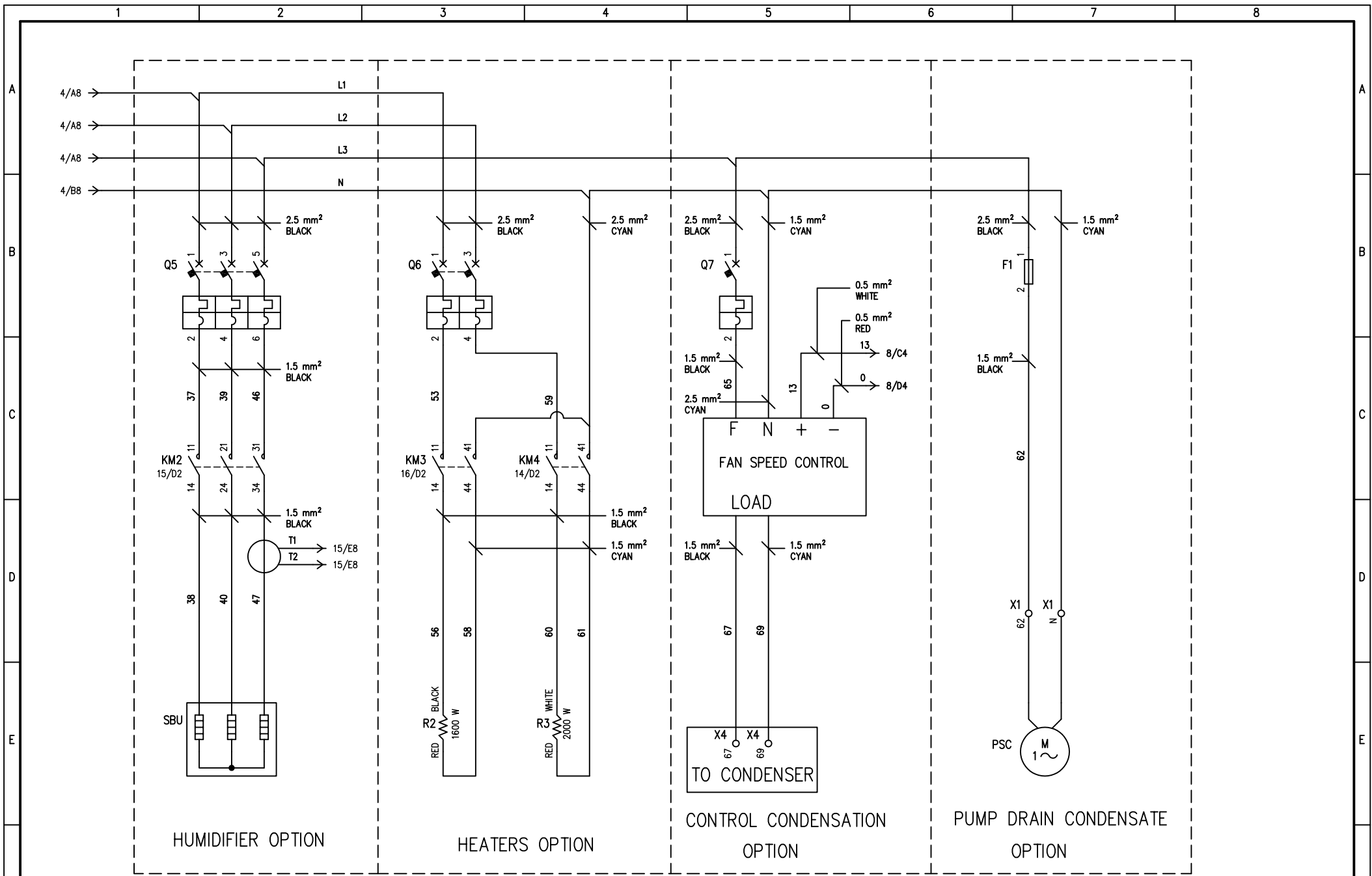

A	REVISIONE GENERALE	10/07/2008	N.C.1	DATE	07/09/2007
B	REVISIONE GENERALE	10/09/2008	N.C.1	DRAW.	N.C.1
C	REVISIONE GENERALE	25/10/2008	N.C.1	CHECK	F.F.1
REV.	MODIFICATIONS	DATE	SIGN.	APPR.	M.M.



HF620C0750

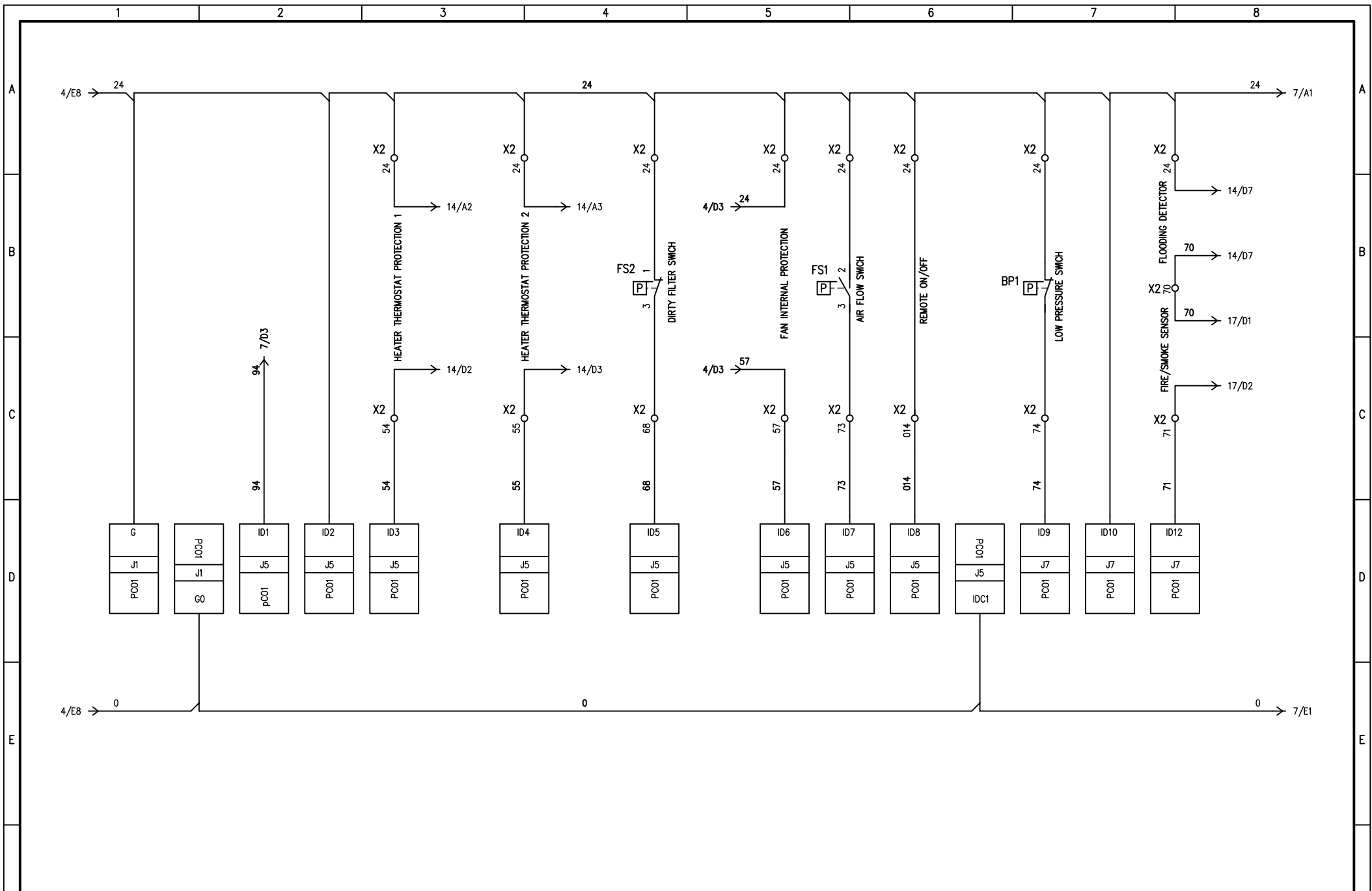

A	REVISIONE GENERALE	10/07/2008	N.C.1	DATE	07/09/2007		HF620C0750	SHEET	6 OF 30
B	REVISIONE GENERALE	10/09/2008	N.C.1	DRAW.	N.C.1			CONTINUE	7
C	REVISIONE GENERALE	25/10/2008	N.C.1	CHECK	F.F.1				
REV.	MODIFICATIONS	DATE	SIGN.	APPR.	M.M.				

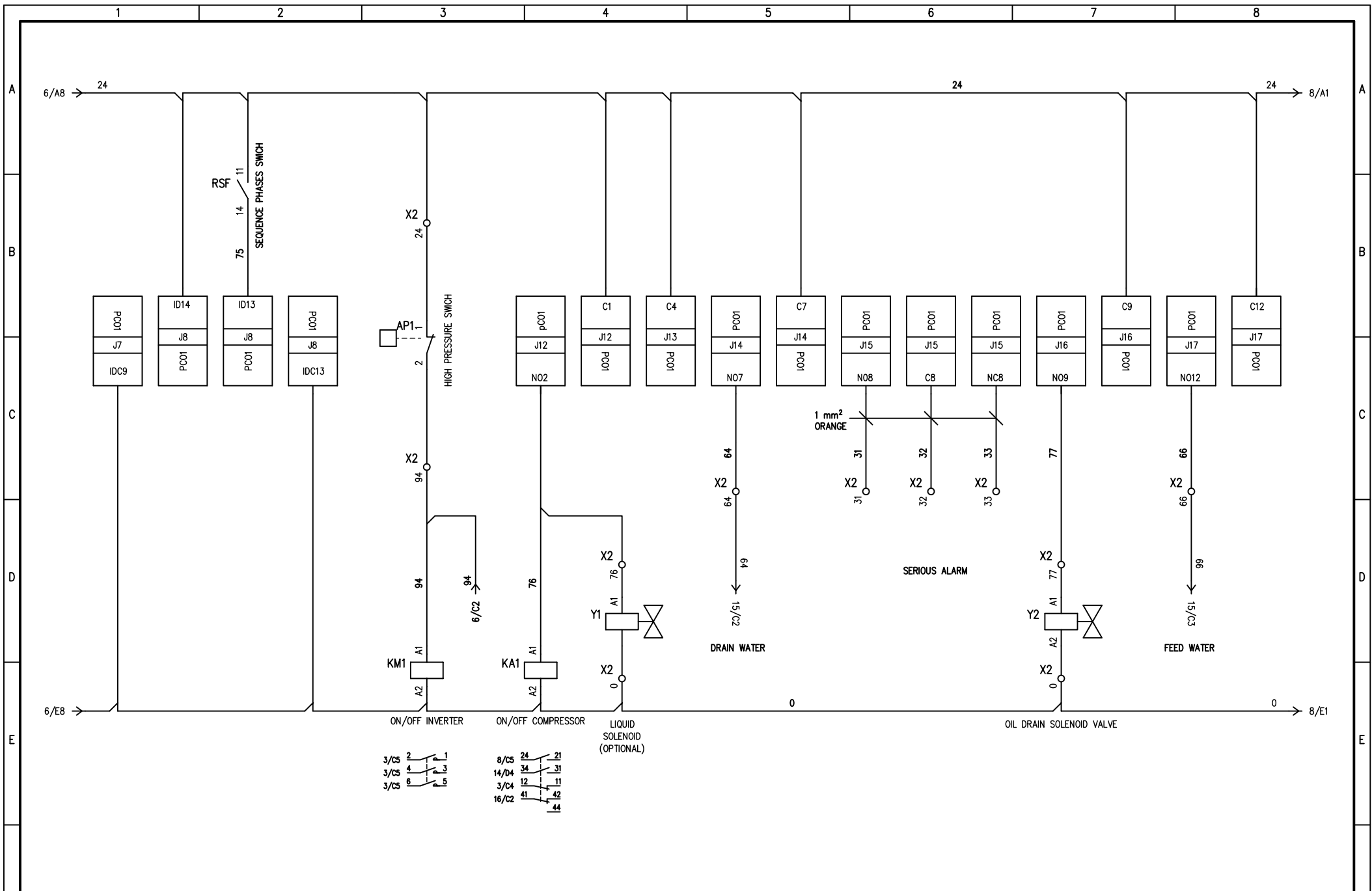

A	REVISIONE GENERALE	10/07/2008	N.C.1	DATE	07/09/2007
B	REVISIONE GENERALE	10/09/2008	N.C.1	DRAW.	N.C.1
C	REVISIONE GENERALE	25/10/2008	N.C.1	CHECK	F.F.1
REV.	MODIFICATIONS	DATE	SIGN.	APPR.	M.M.



HF620C0750

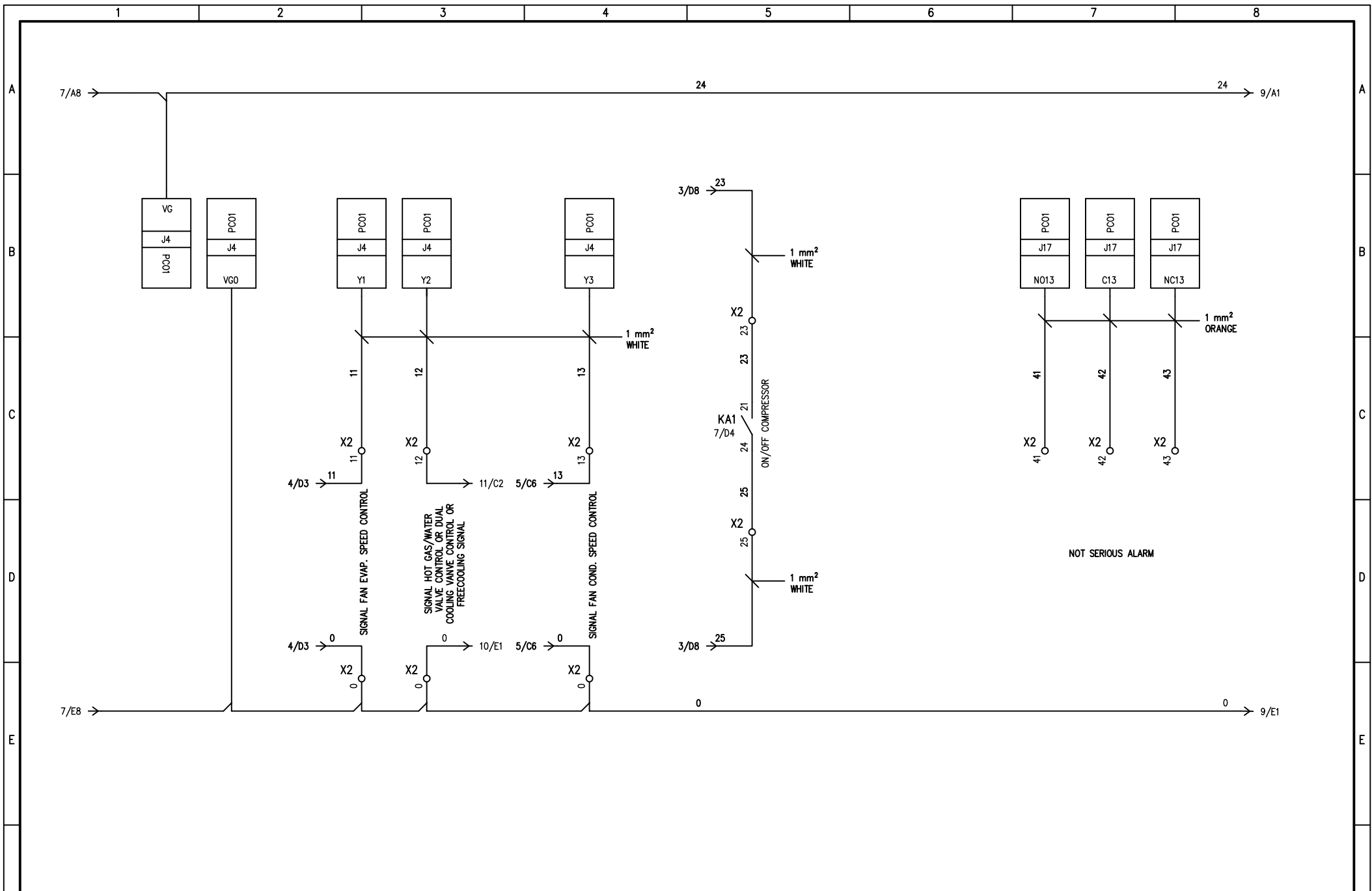

A	REVISIONE GENERALE	10/07/2008	N.C.1	DATE	07/09/2007		HF620C0750	SHEET	8 OF 30
B	REVISIONE GENERALE	10/09/2008	N.C.1	DRAW.	N.C.1			CONTINUE	9
C	REVISIONE GENERALE	25/10/2008	N.C.1	CHECK	F.F.1				
REV.	MODIFICATIONS	DATE	SIGN.	APPR.	M.M.				

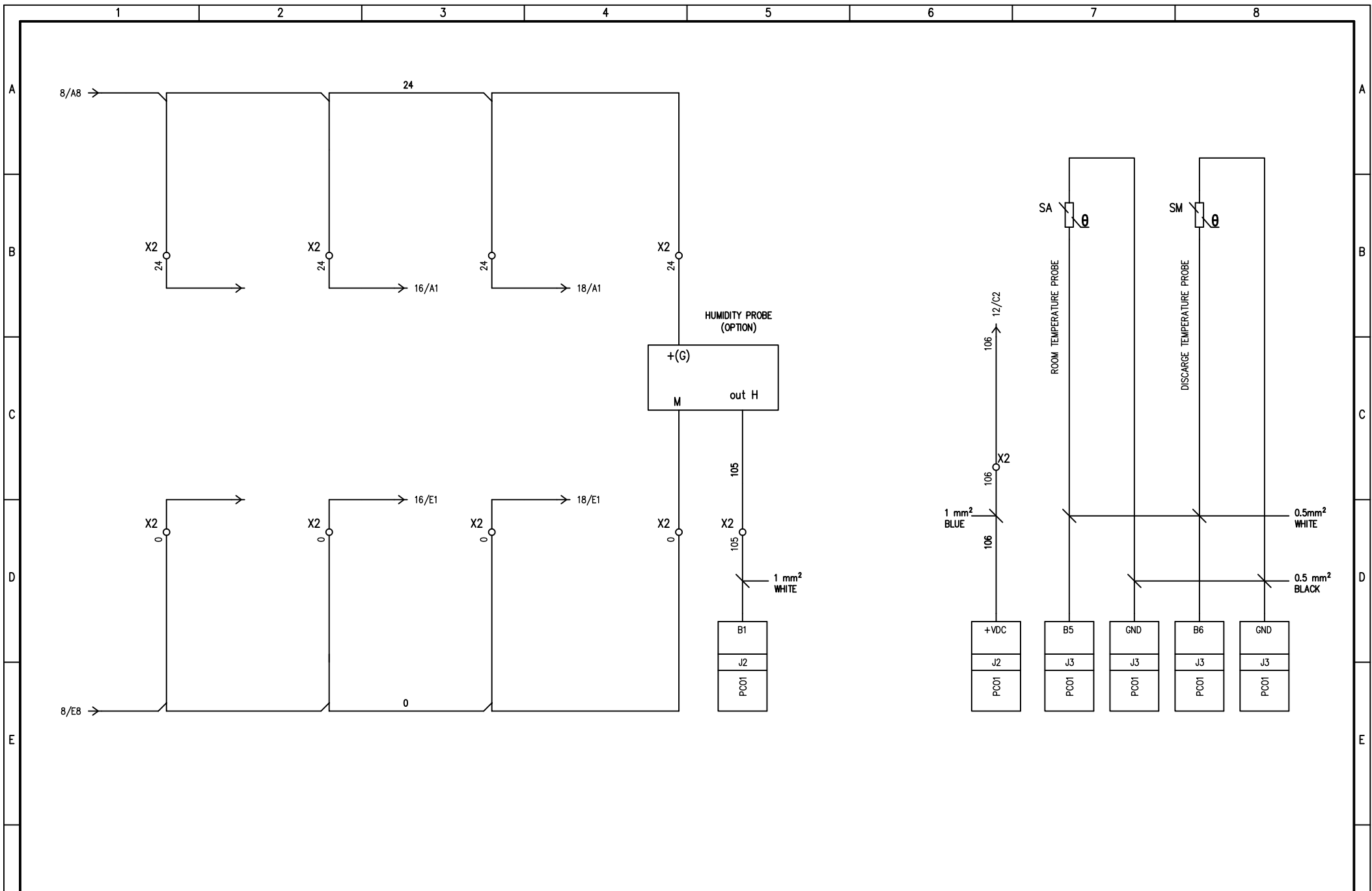

A	REVISIONE GENERALE	10/07/2008	N.C.1	DATE	07/09/2007
B	REVISIONE GENERALE	10/09/2008	N.C.1	DRAW.	N.C.1
C	REVISIONE GENERALE	25/10/2008	N.C.1	CHECK	F.F.1
REV.	MODIFICATIONS	DATE	SIGN.	APPR.	M.M.



HF620C0750

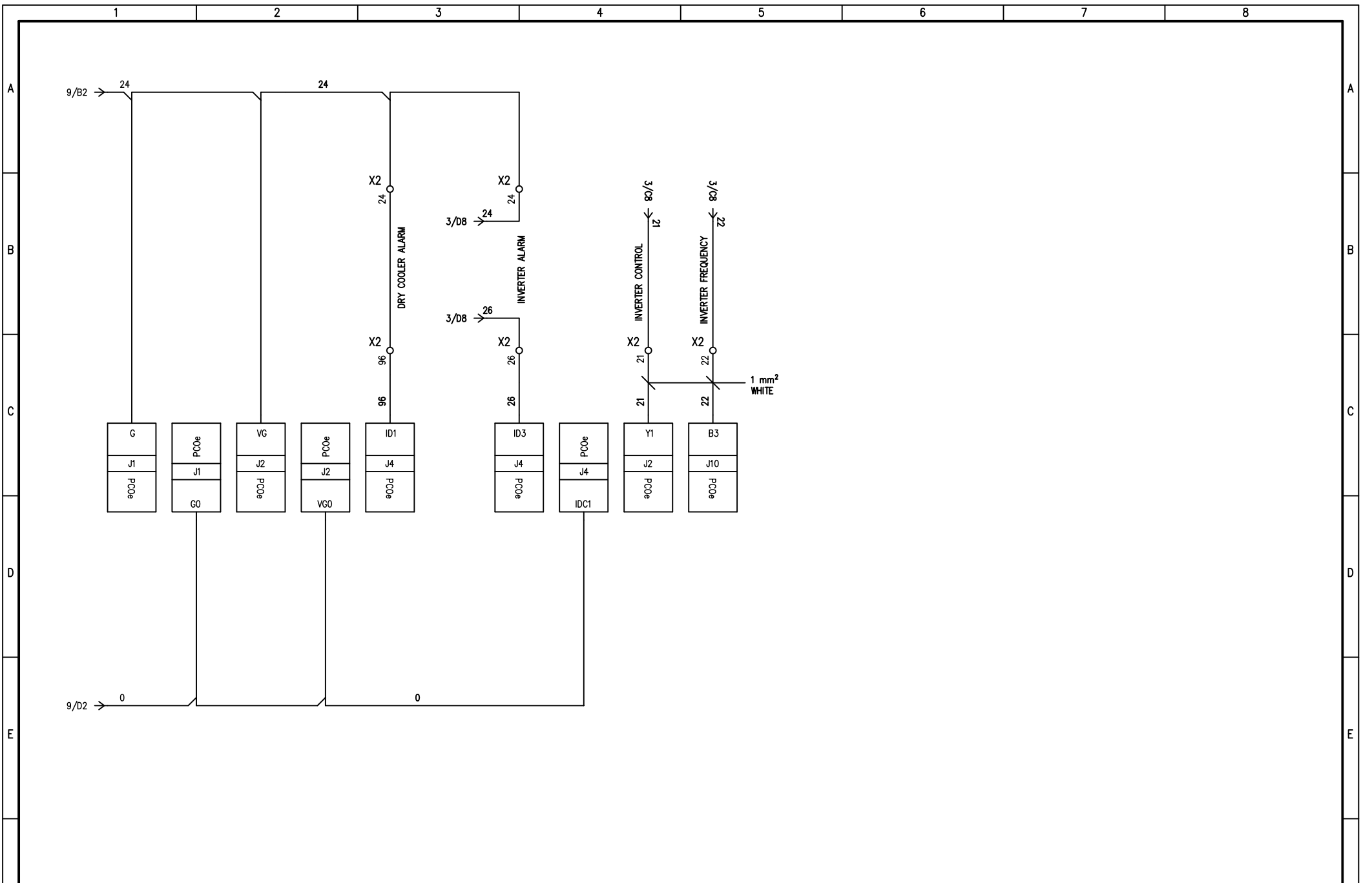

A	REVISIONE GENERALE	10/07/2008	N.C.1	DATE	07/09/2007		HF620C0750	SHEET 10 OF 30
B	REVISIONE GENERALE	10/09/2008	N.C.1	DRAW.	N.C.1			
C	REVISIONE GENERALE	25/10/2008	N.C.1	CHECK	F.F.1			
REV.	MODIFICATIONS	DATE	SIGN.	APPR.	M.M.			
	1	2	3	4	5	6	7	8
							CONTINUE 11	

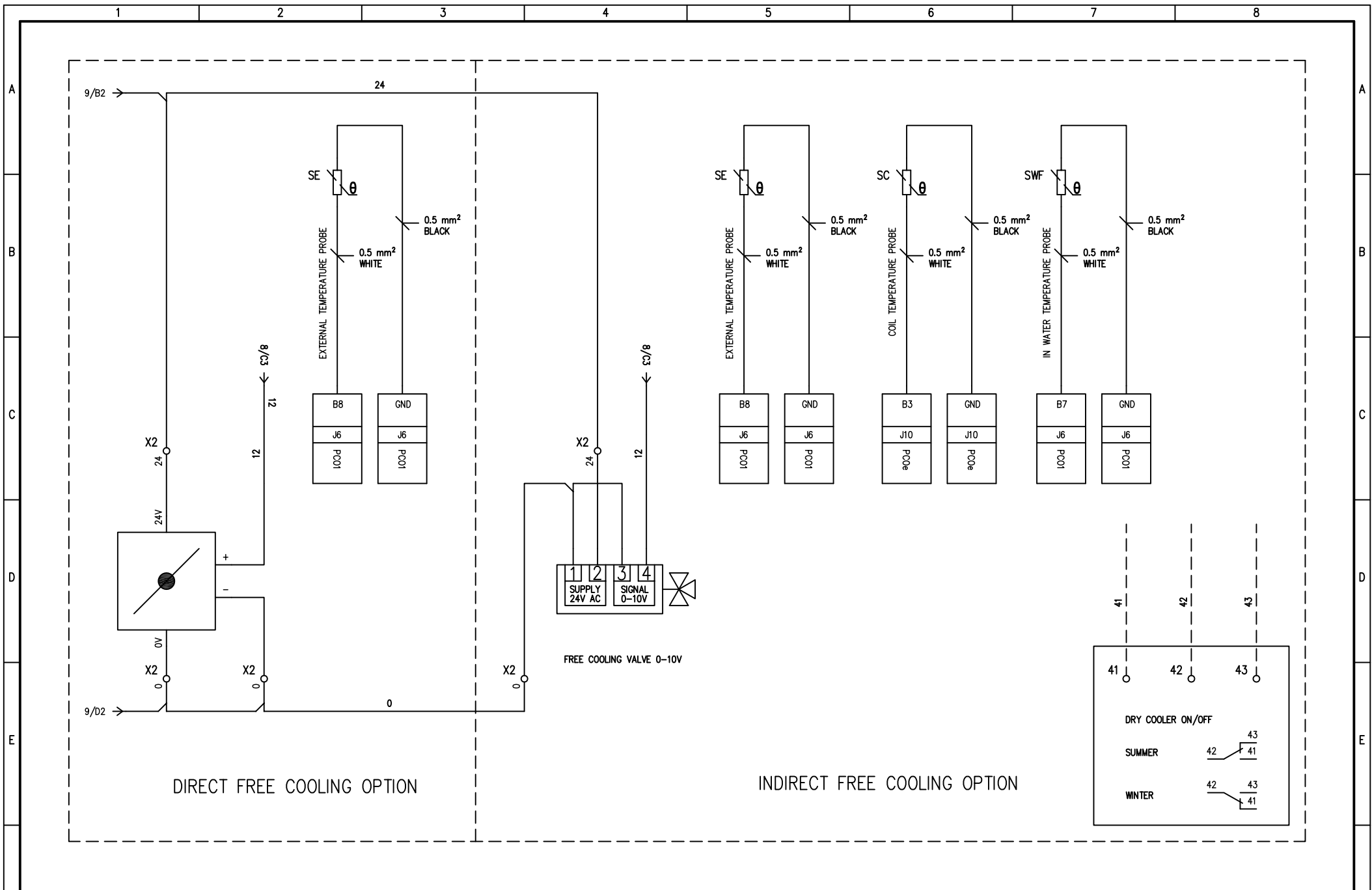

A	REVISIONE GENERALE	10/07/2008	N.C.1	DATE	07/09/2007
B	REVISIONE GENERALE	10/09/2008	N.C.1	DRAW.	N.C.1
C	REVISIONE GENERALE	25/10/2008	N.C.1	CHECK	F.F.1
REV.	MODIFICATIONS	DATE	SIGN.	APPR.	M.M.



HF620C0750

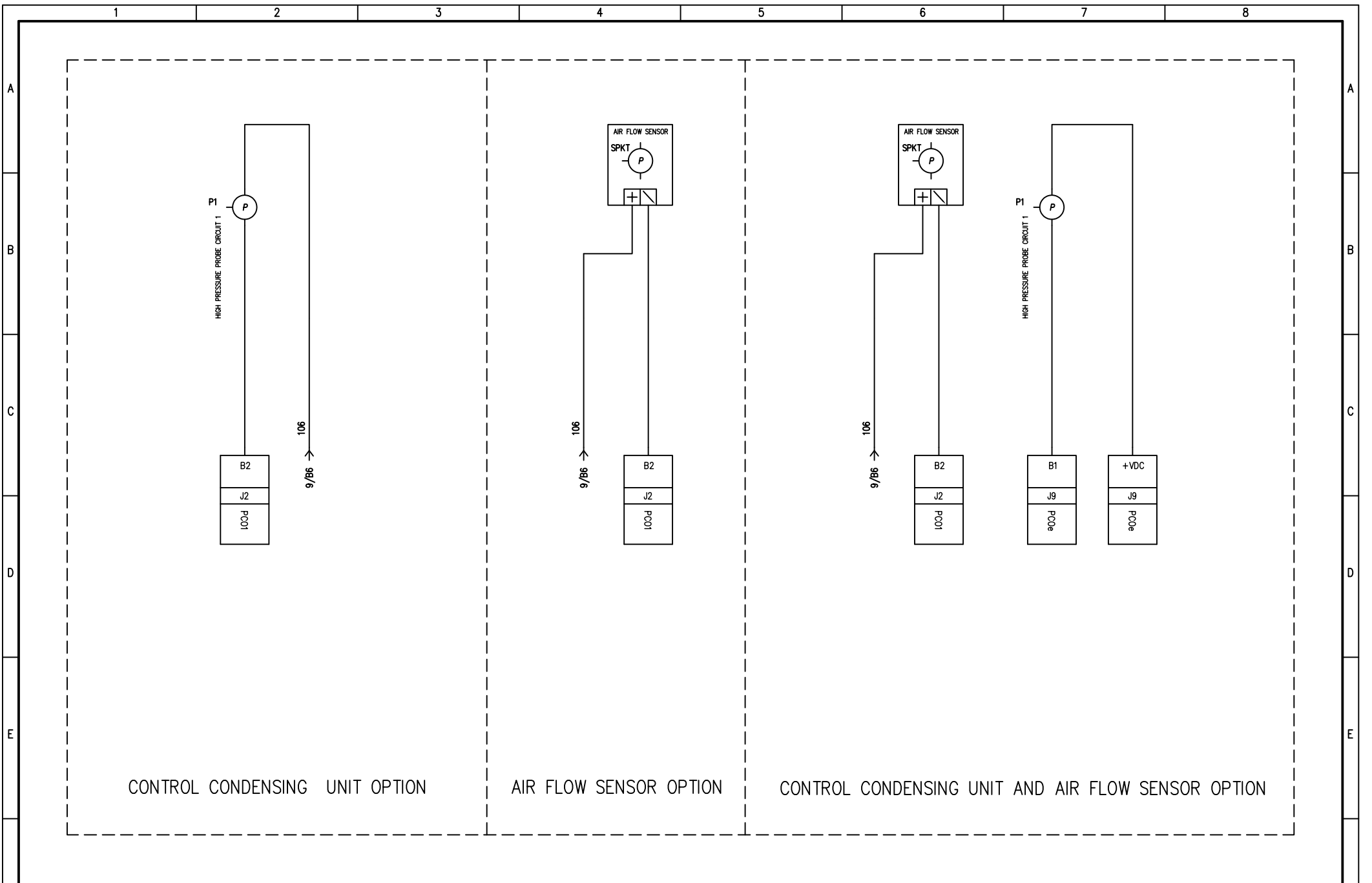

CONTROL CONDENSING UNIT OPTION

AIR FLOW SENSOR OPTION

CONTROL CONDENSING UNIT AND AIR FLOW SENSOR OPTION

A	REVISIONE GENERALE	10/07/2008	N.C.1	DATE	07/09/2007
B	REVISIONE GENERALE	10/09/2008	N.C.1	DRAW.	N.C.1
C	REVISIONE GENERALE	25/10/2008	N.C.1	CHECK	F.F.1
REV.	MODIFICATIONS	DATE	SIGN.	APPR.	M.M.



HF620C0750

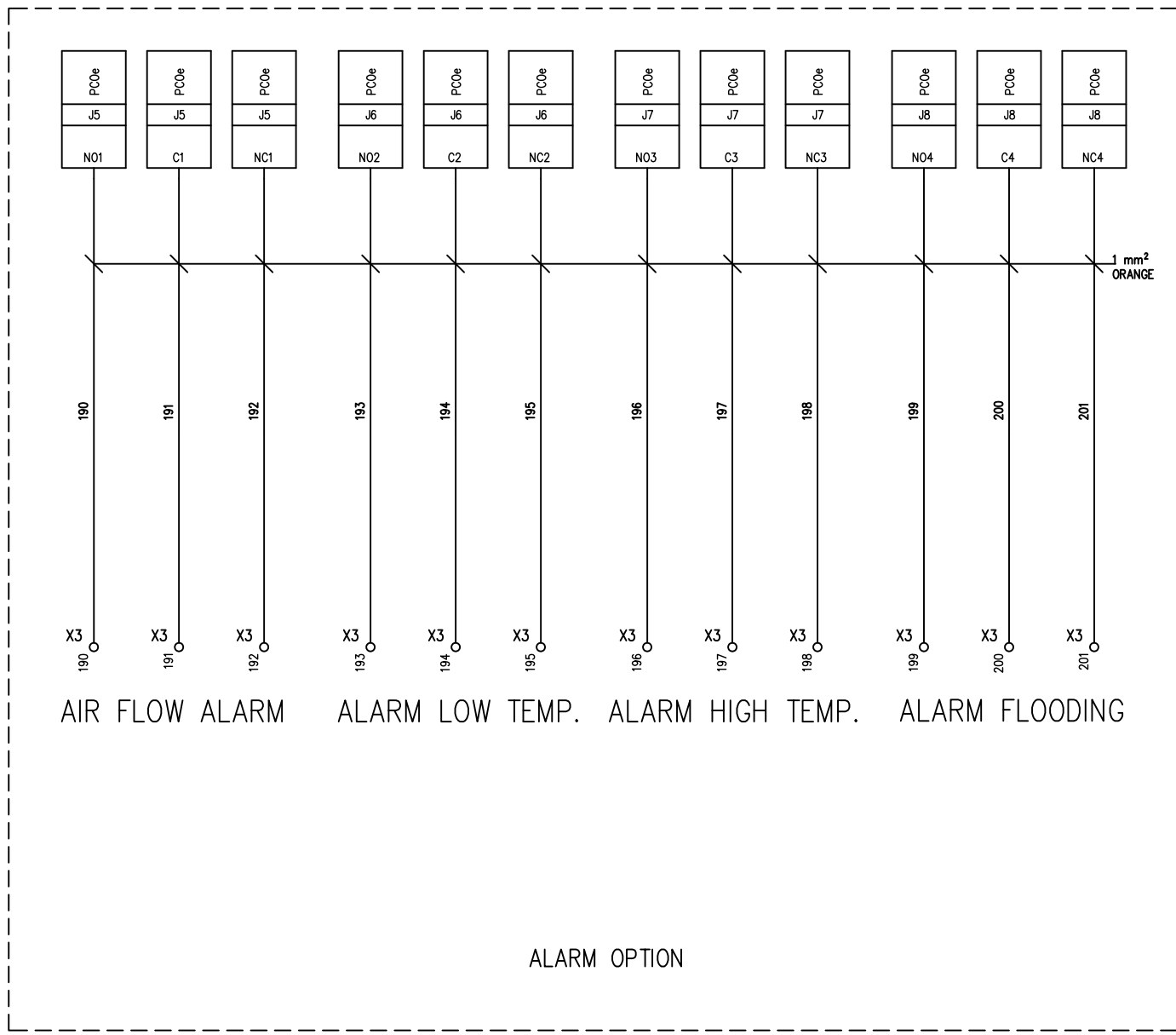

A	REVISIONE GENERALE	10/07/2008	N.C.1	DATE	07/09/2007
B	REVISIONE GENERALE	10/09/2008	N.C.1	DRAW.	N.C.1
C	REVISIONE GENERALE	25/10/2008	N.C.1	CHECK	F.F.1
REV.	MODIFICATIONS	DATE	SIGN.	APPR.	M.M.



HF620C0750

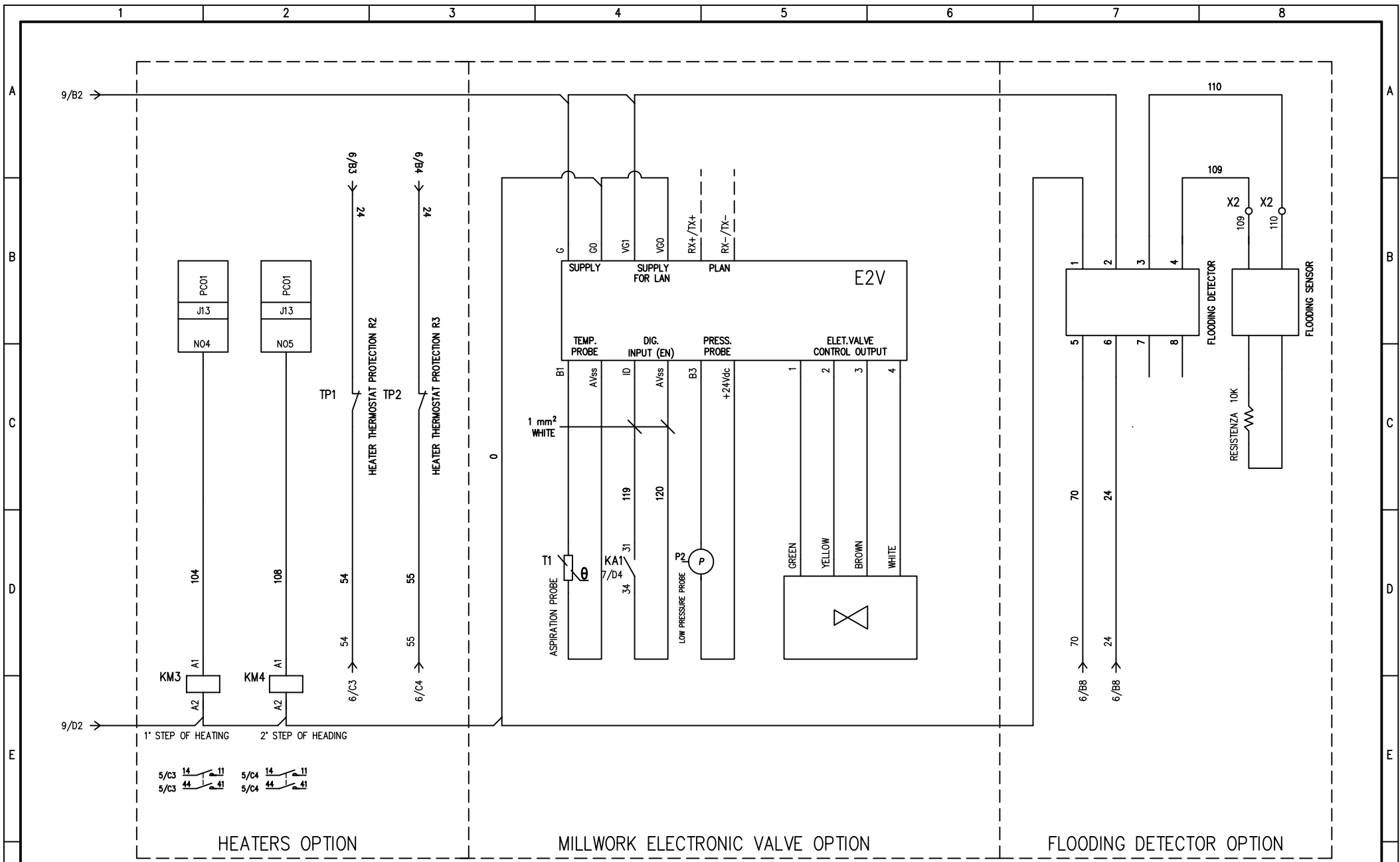

A	REVISIONE GENERALE	10/07/2008	N.C.1	DATE	07/09/2007
B	REVISIONE GENERALE	10/09/2008	N.C.1	DRAW.	N.C.1
C	REVISIONE GENERALE	25/10/2008	N.C.1	CHECK	F.F.1
REV.	MODIFICATIONS	DATE	SIGN.	APPR.	M.M.



HF620C0750

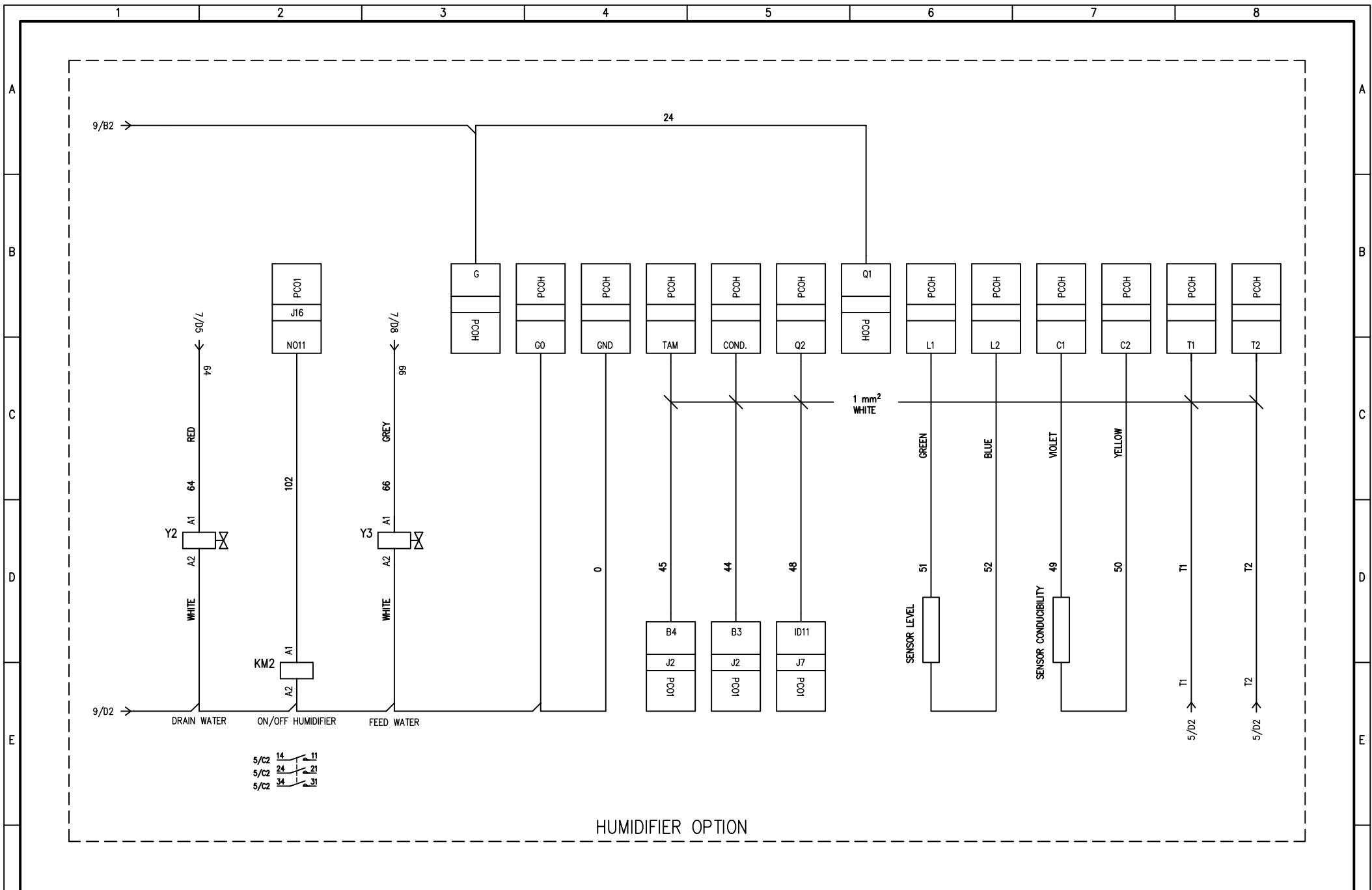

HUMIDIFIER OPTION

A	REVISIONE GENERALE	10/07/2008	N.C.1	DATE	07/09/2007
B	REVISIONE GENERALE	10/09/2008	N.C.1	DRAW.	N.C.1
C	REVISIONE GENERALE	25/10/2008	N.C.1	CHECK	F.F.1
REV.	MODIFICATIONS	DATE	SIGN.	APPR.	M.M.



HF620C0750

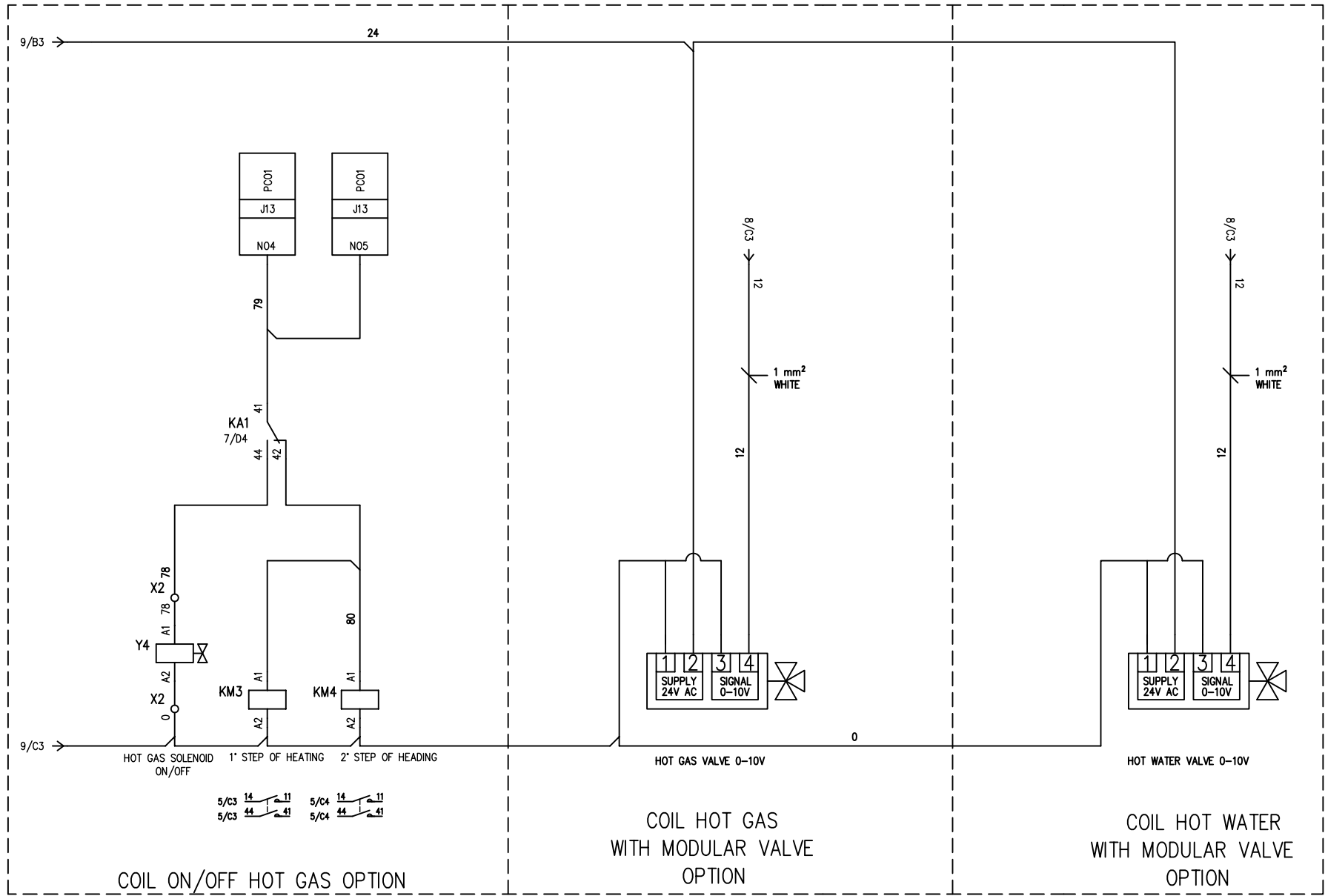

A	REVISIONE GENERALE	10/07/2008	N.C.1	DATE	07/09/2007
B	REVISIONE GENERALE	10/09/2008	N.C.1	DRAW.	N.C.1
C	REVISIONE GENERALE	25/10/2008	N.C.1	CHECK	F.F.1
REV.	MODIFICATIONS	DATE	SIGN.	APPR.	M.M.



HF620C0750

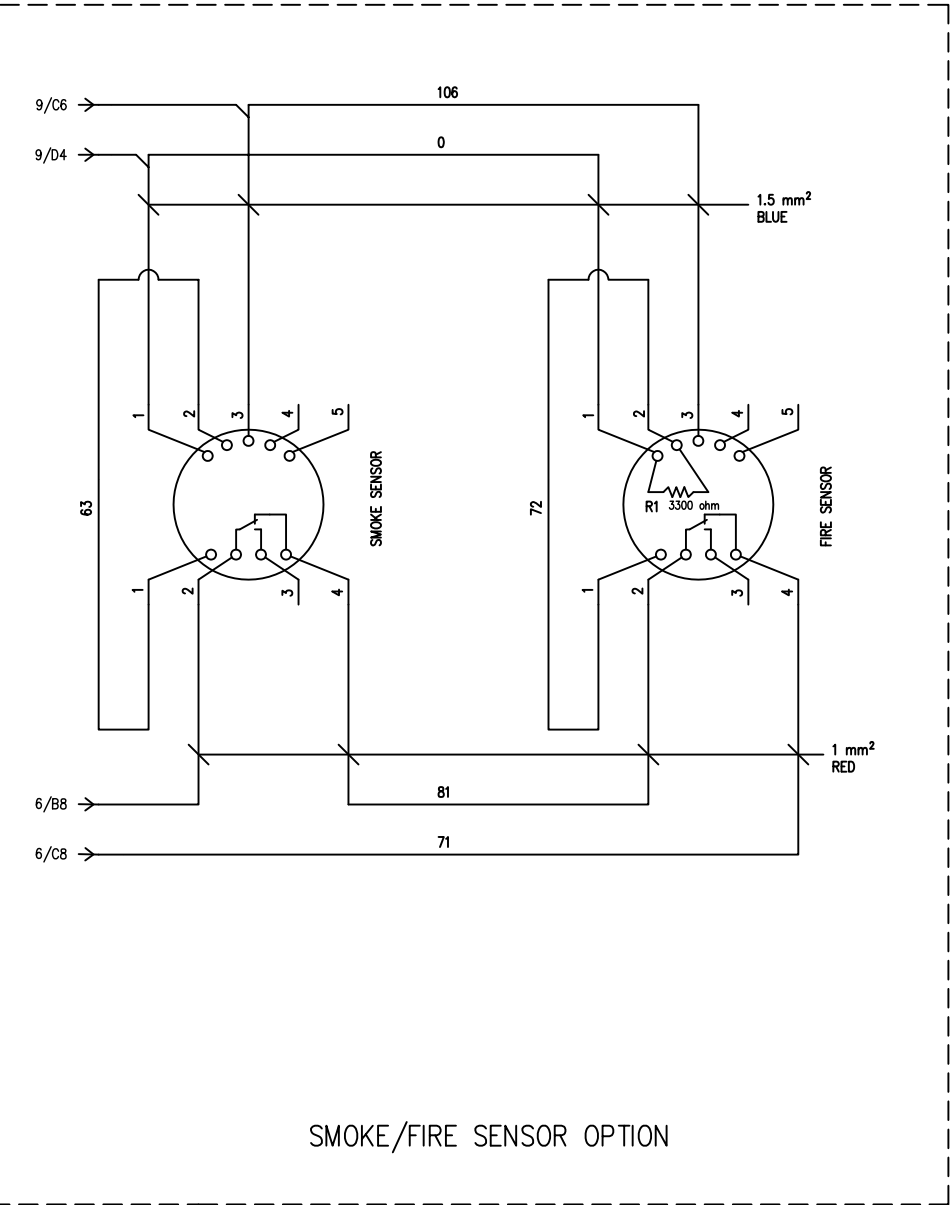
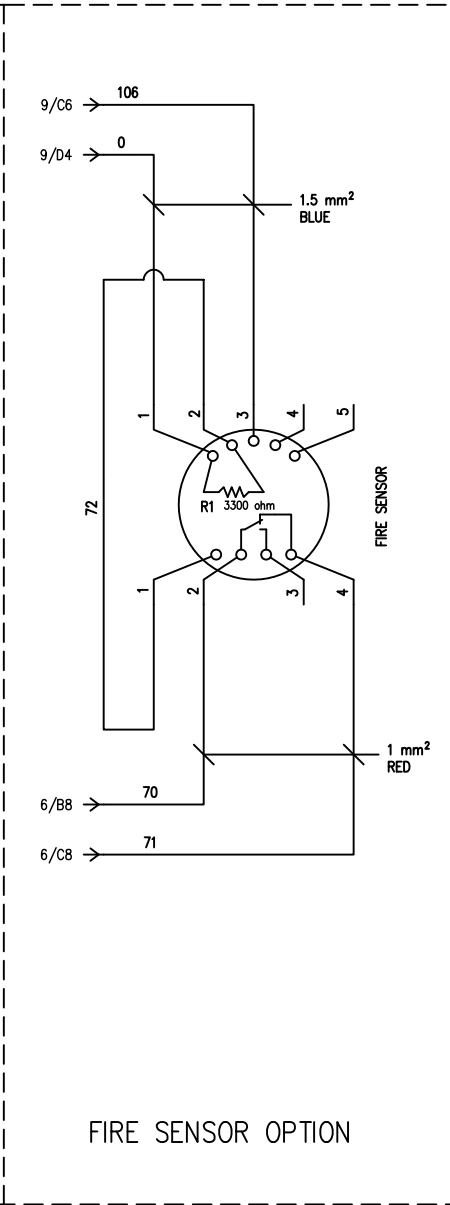
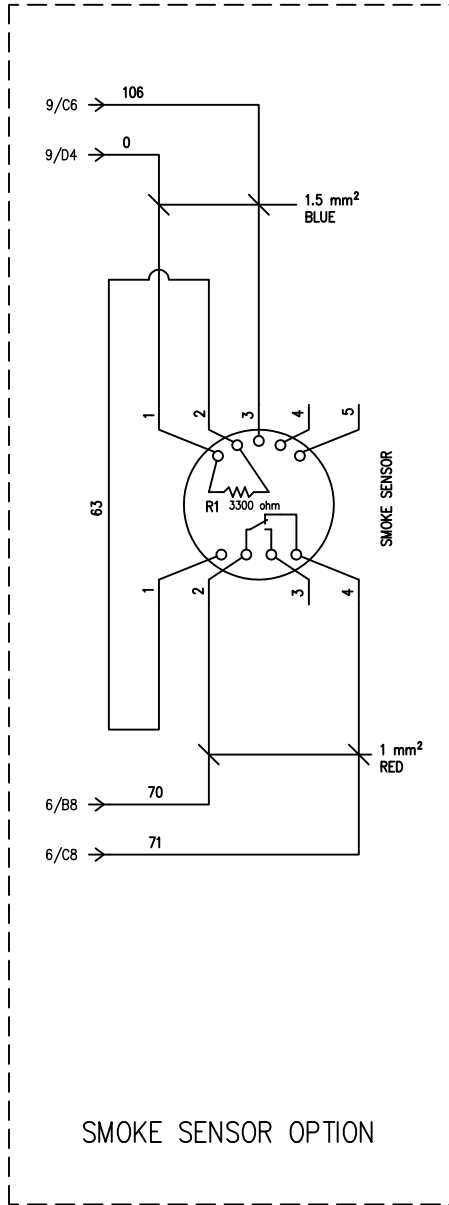

A	REVISIONE GENERALE	10/07/2008	N.C.1	DATE	07/09/2007
B	REVISIONE GENERALE	10/09/2008	N.C.1	DRAW.	N.C.1
C	REVISIONE GENERALE	25/10/2008	N.C.1	CHECK	F.F.1
REV.	MODIFICATIONS	DATE	SIGN.	APPR.	M.M.



HF620C0750

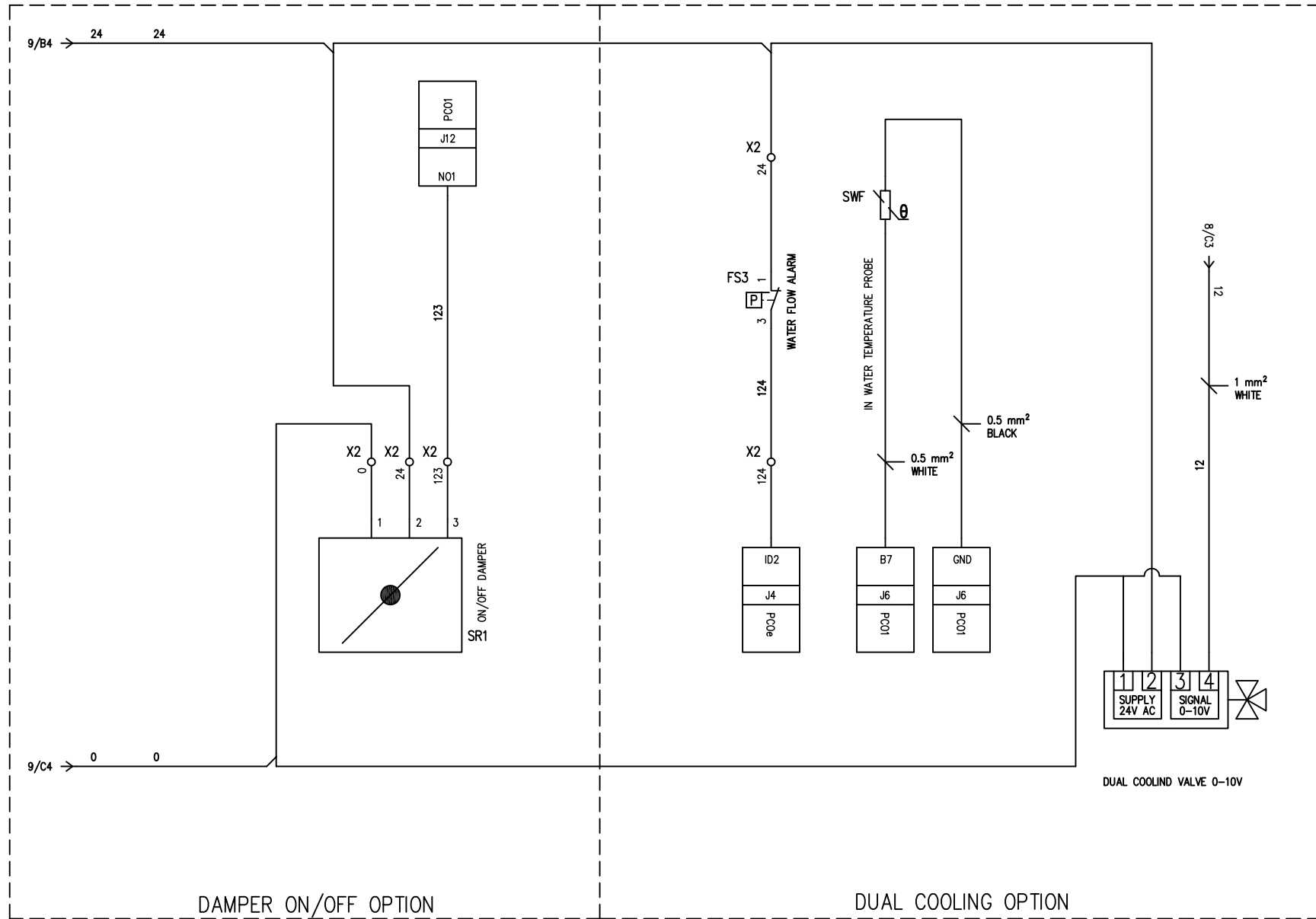

A	REVISIONE GENERALE	10/07/2008	N.C.1	DATE	07/09/2007
B	REVISIONE GENERALE	10/09/2008	N.C.1	DRAW.	N.C.1
C	REVISIONE GENERALE	25/10/2008	N.C.1	CHECK	F.F.1
REV.	MODIFICATIONS	DATE	SIGN.	APPR.	M.M.



HF620C0750

pLAN CONNECTION

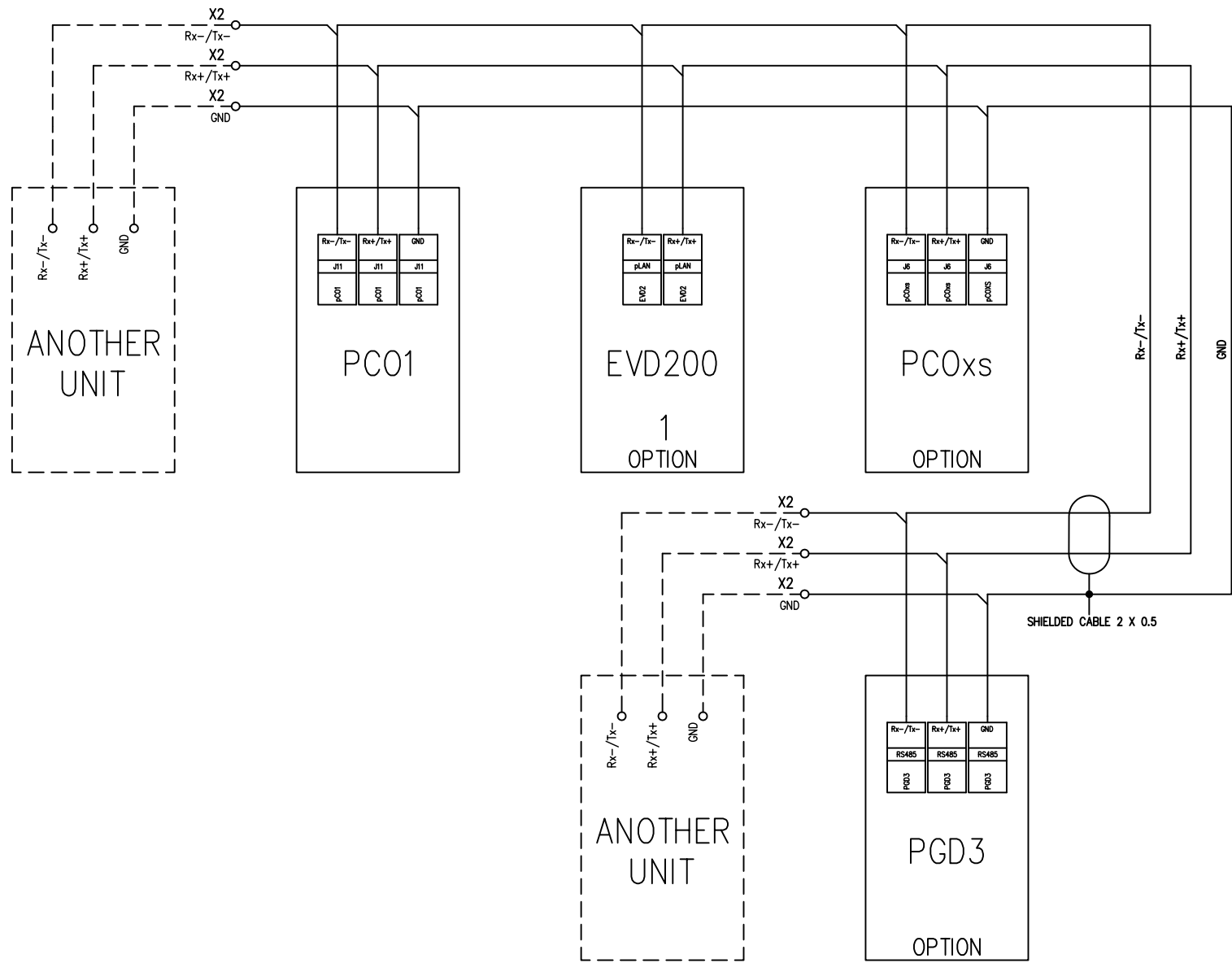

A	REVISIONE GENERALE	10/07/2008	N.C.1	DATE	07/09/2007
B	REVISIONE GENERALE	10/09/2008	N.C.1	DRAW.	N.C.1
C	REVISIONE GENERALE	25/10/2008	N.C.1	CHECK	F.F.1
REV.	MODIFICATIONS	DATE	SIGN.	APPR.	M.M.



HF620C0750

TERMINAL STRIP

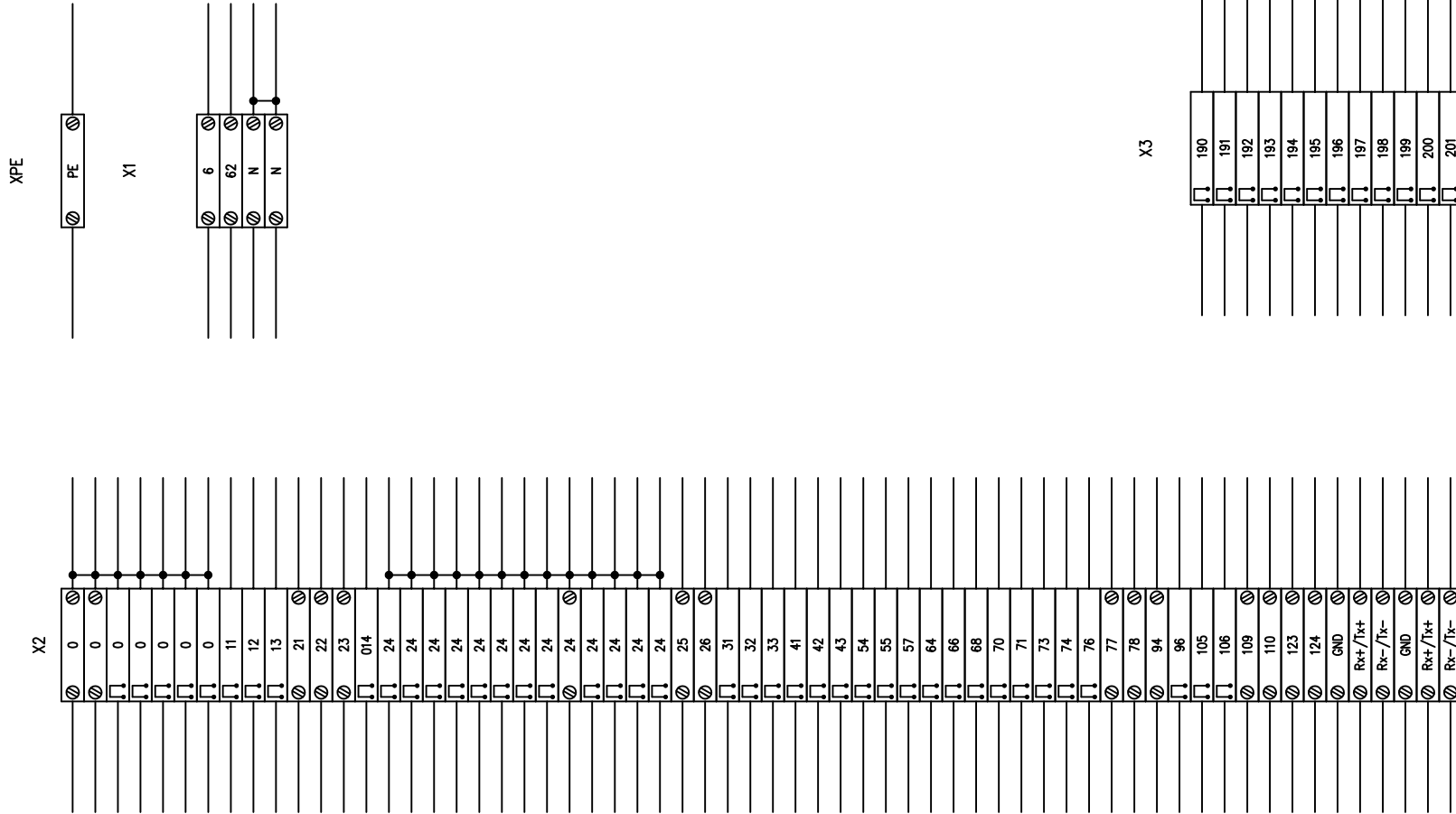

A	REVISIONE GENERALE	10/07/2008	N.C.1	DATE	07/09/2007
B	REVISIONE GENERALE	10/09/2008	N.C.1	DRAW.	N.C.1
C	REVISIONE GENERALE	25/10/2008	N.C.1	CHECK	F.F.1
REV.	MODIFICATIONS	DATE	SIGN.	APPR.	M.M.



HF620C0750

USER CONNECTION

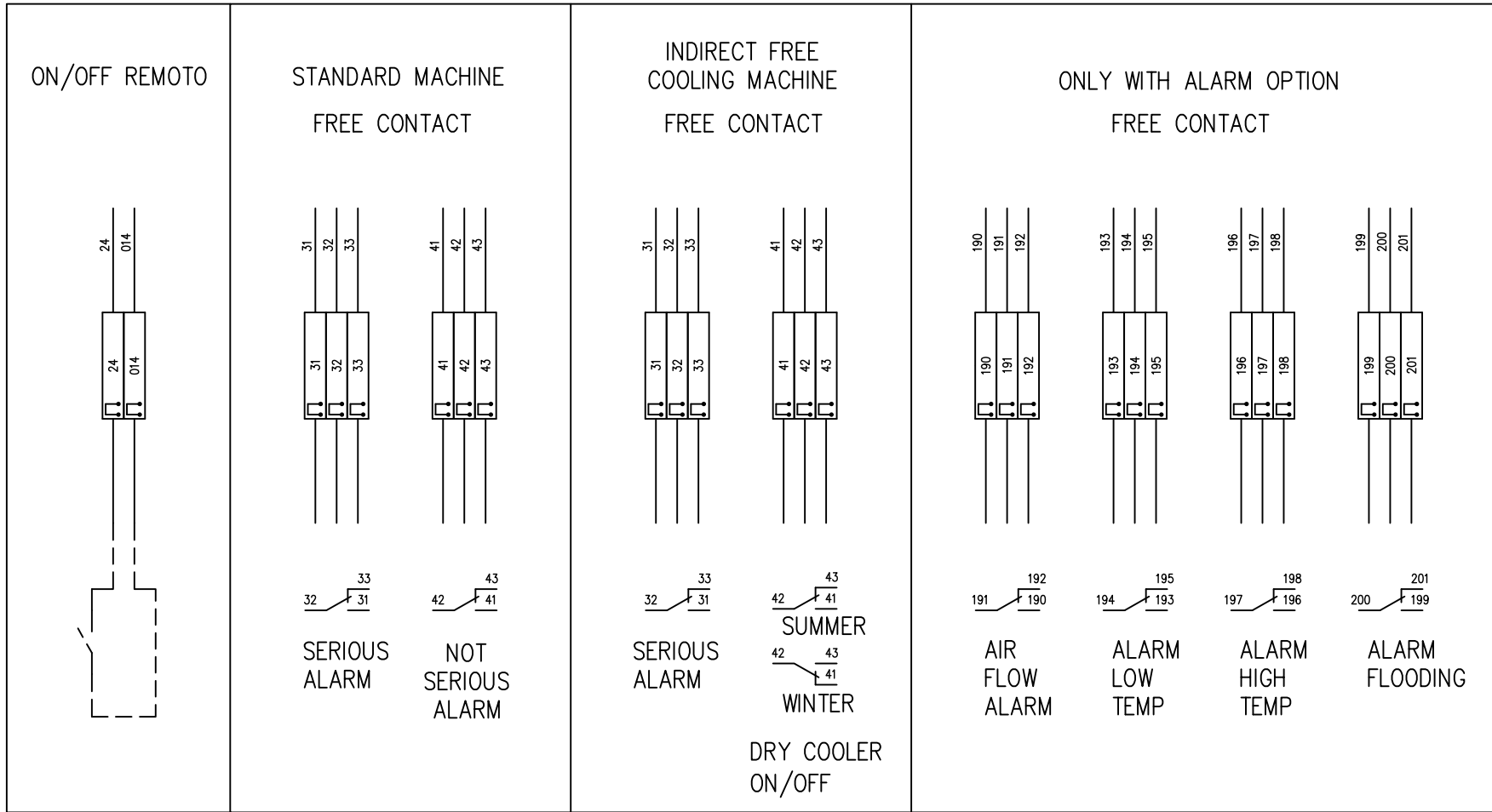

A	REVISIONE GENERALE	10/07/2008	N.C.1	DATE	07/09/2007
B	REVISIONE GENERALE	10/09/2008	N.C.1	DRAW.	N.C.1
C	REVISIONE GENERALE	25/10/2008	N.C.1	CHECK	F.F.1
REV.	MODIFICATIONS	DATE	SIGN.	APPR.	M.M.



HF620C0750

LA LUNGHEZZA DEI CAVI E' RIFERITA ALL'ESTERNO DEL QUADRO

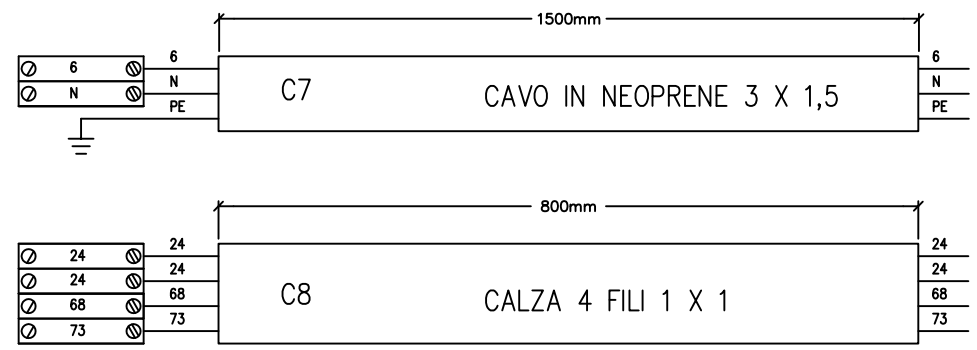
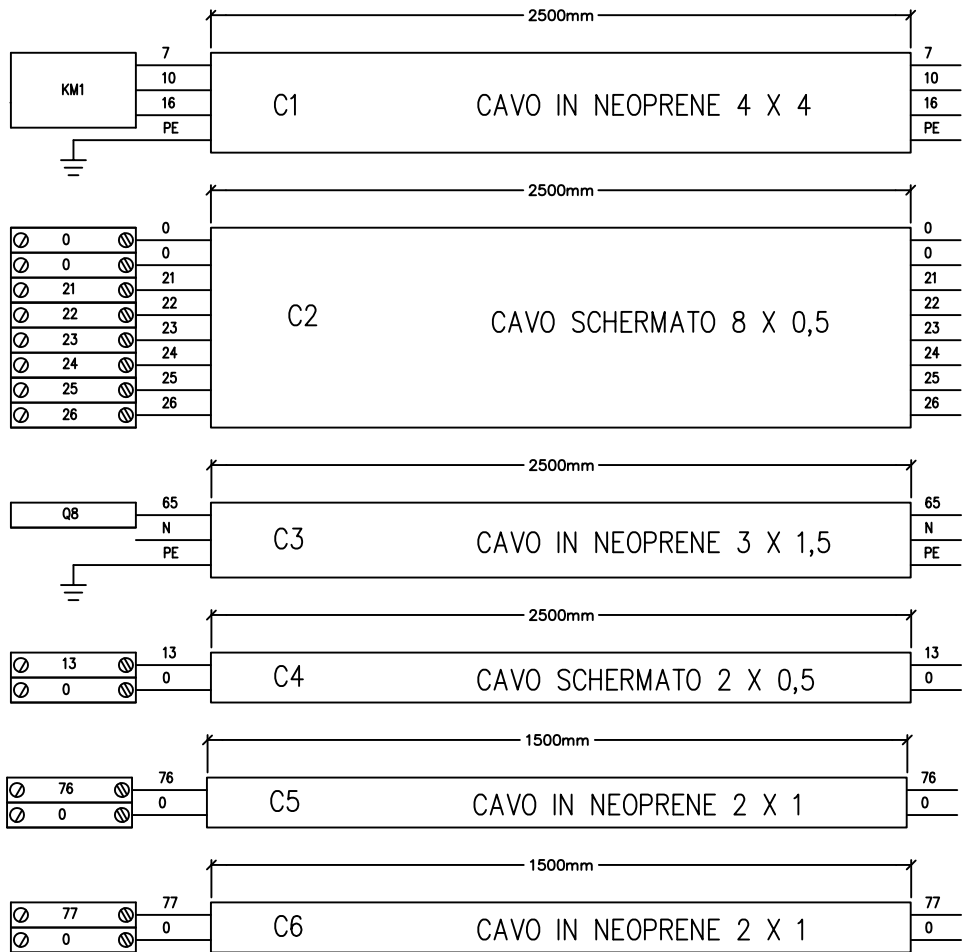

A	REVISIONE GENERALE	10/07/2008	N.C.1	DATE	07/09/2007
B	REVISIONE GENERALE	10/09/2008	N.C.1	DRAW.	N.C.1
C	REVISIONE GENERALE	25/10/2008	N.C.1	CHECK	F.F.1
REV.	MODIFICATIONS	DATE	SIGN.	APPR.	M.M.



HF620C0750

LAYOUT PIASTRA DI FONDO

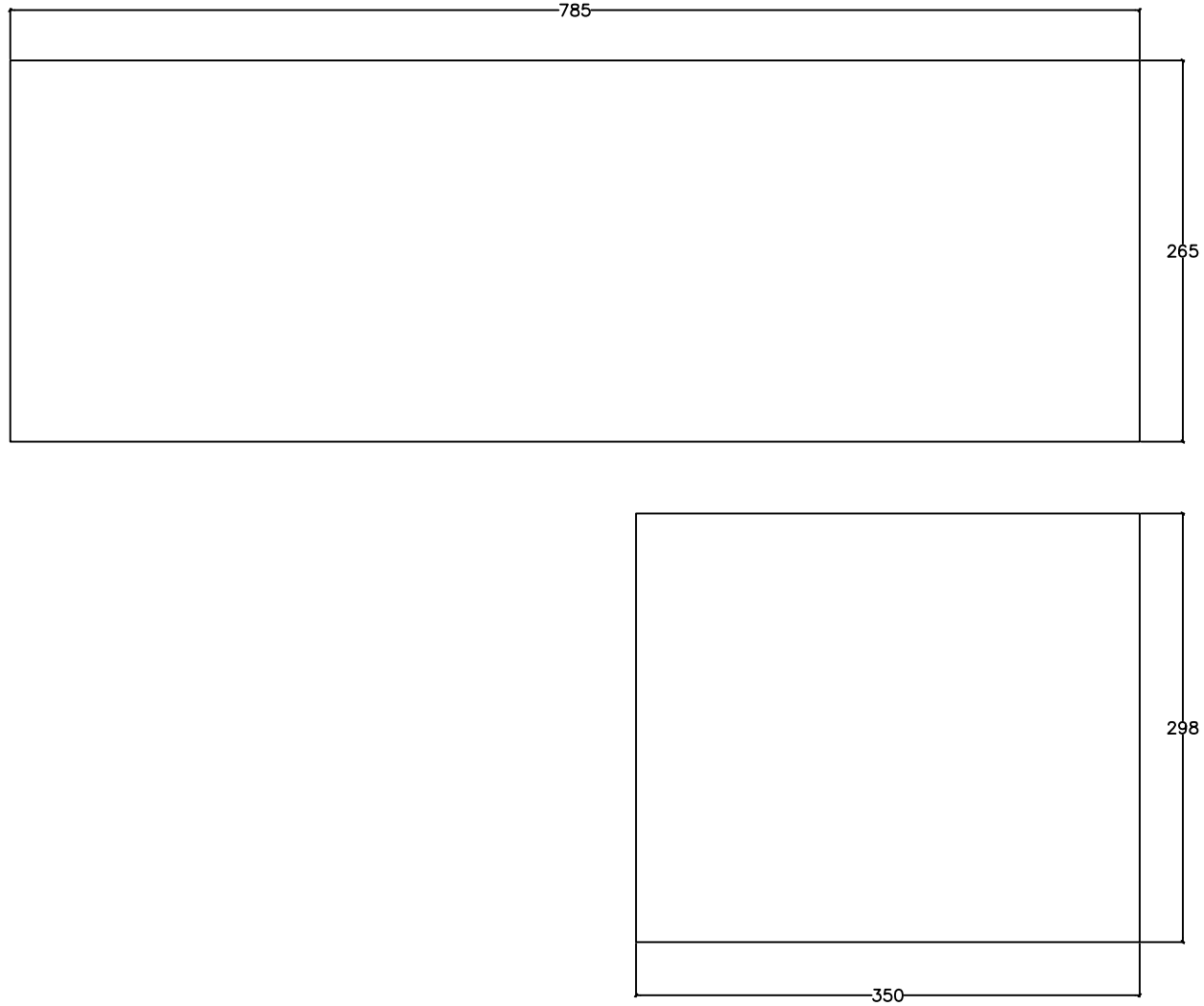

A	REVISIONE GENERALE	10/07/2008	N.C.1	DATE	07/09/2007
B	REVISIONE GENERALE	10/09/2008	N.C.1	DRAW.	N.C.1
C	REVISIONE GENERALE	25/10/2008	N.C.1	CHECK	F.F.1
REV.	MODIFICATIONS	DATE	SIGN.	APPR.	M.M.



HF620C0750

LAYOUT DISTRIBUZIONE CANALINE

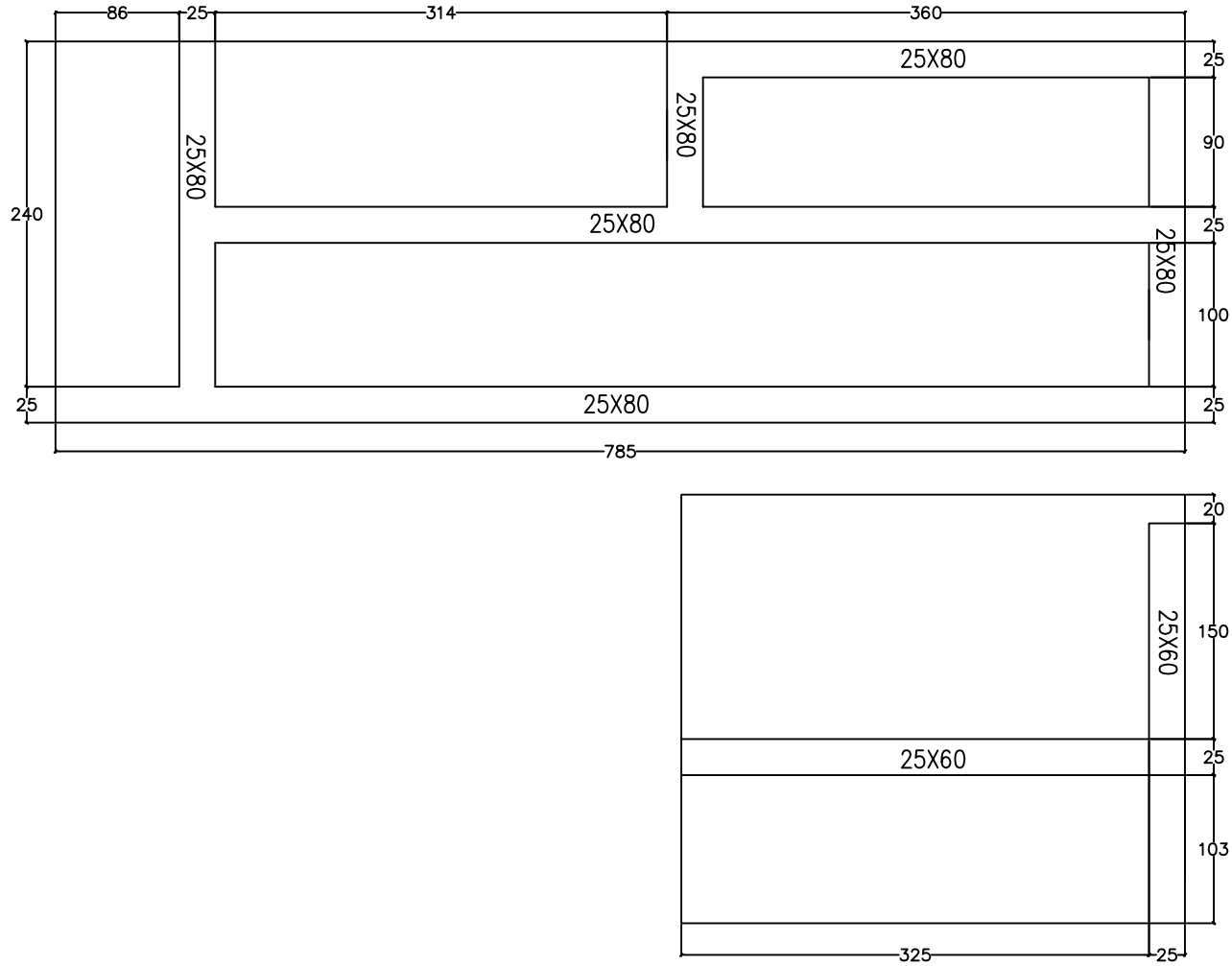

A	REVISIONE GENERALE	10/07/2008	N.C.1	DATE	07/09/2007
B	REVISIONE GENERALE	10/09/2008	N.C.1	DRAW.	N.C.1
C	REVISIONE GENERALE	25/10/2008	N.C.1	CHECK	F.F.1
REV.	MODIFICATIONS	DATE	SIGN.	APPR.	M.M.



HF620C0750

SHEET 24 OF 30
CONTINUE 25

LAYOUT DISTRIBUZIONE GUIDE DIN

LE GUIDE DIN DEVONO AVERE ALTEZZA 5mm

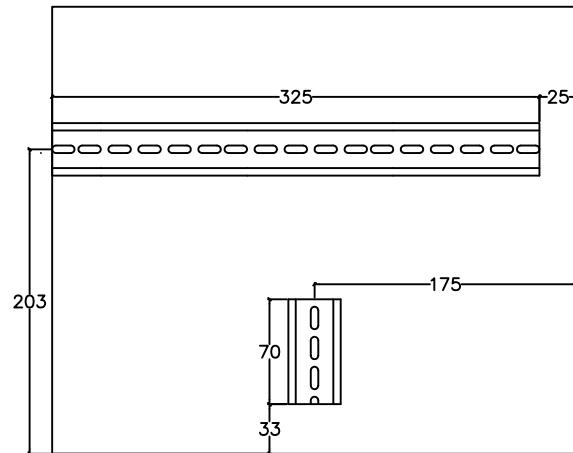
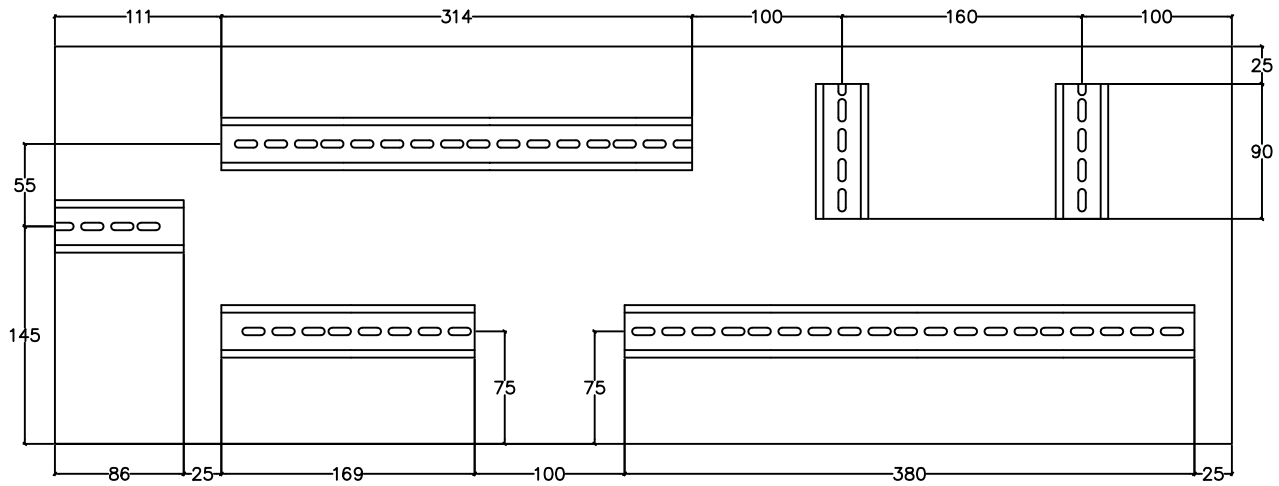

A	REVISIONE GENERALE	10/07/2008	N.C.1	DATE	07/09/2007
B	REVISIONE GENERALE	10/09/2008	N.C.1	DRAW.	N.C.1
C	REVISIONE GENERALE	25/10/2008	N.C.1	CHECK	F.F.1
REV.	MODIFICATIONS	DATE	SIGN.	APPR.	M.M.



HF620C0750

SHEET 25 OF 30
CONTINUE 26

LAYOUT COPERTURA IN PLEXIGLASS

LA DISTANZA TRA LA PIASTRA DI FONDO E IL PLEXIGLASS NON DEVE SUPERARE I 95mm

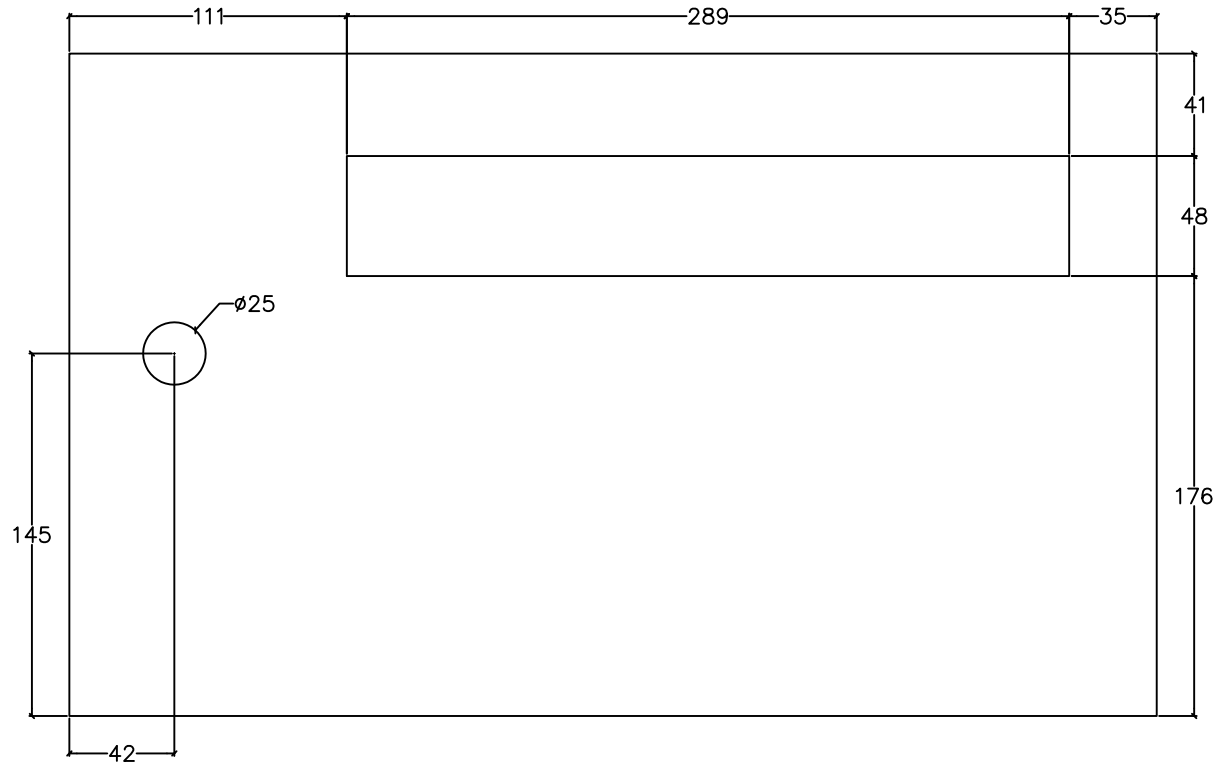

A	REVISIONE GENERALE	10/07/2008	N.C.1	DATE	07/09/2007
B	REVISIONE GENERALE	10/09/2008	N.C.1	DRAW.	N.C.1
C	REVISIONE GENERALE	25/10/2008	N.C.1	CHECK	F.F.1
REV.	MODIFICATIONS	DATE	SIGN.	APPR.	M.M.



HF620C0750

SHEET 26 OF 30
CONTINUE 27

LAYOUT DISTRIBUZIONE DEI COMPONENTI DEL QUADRO

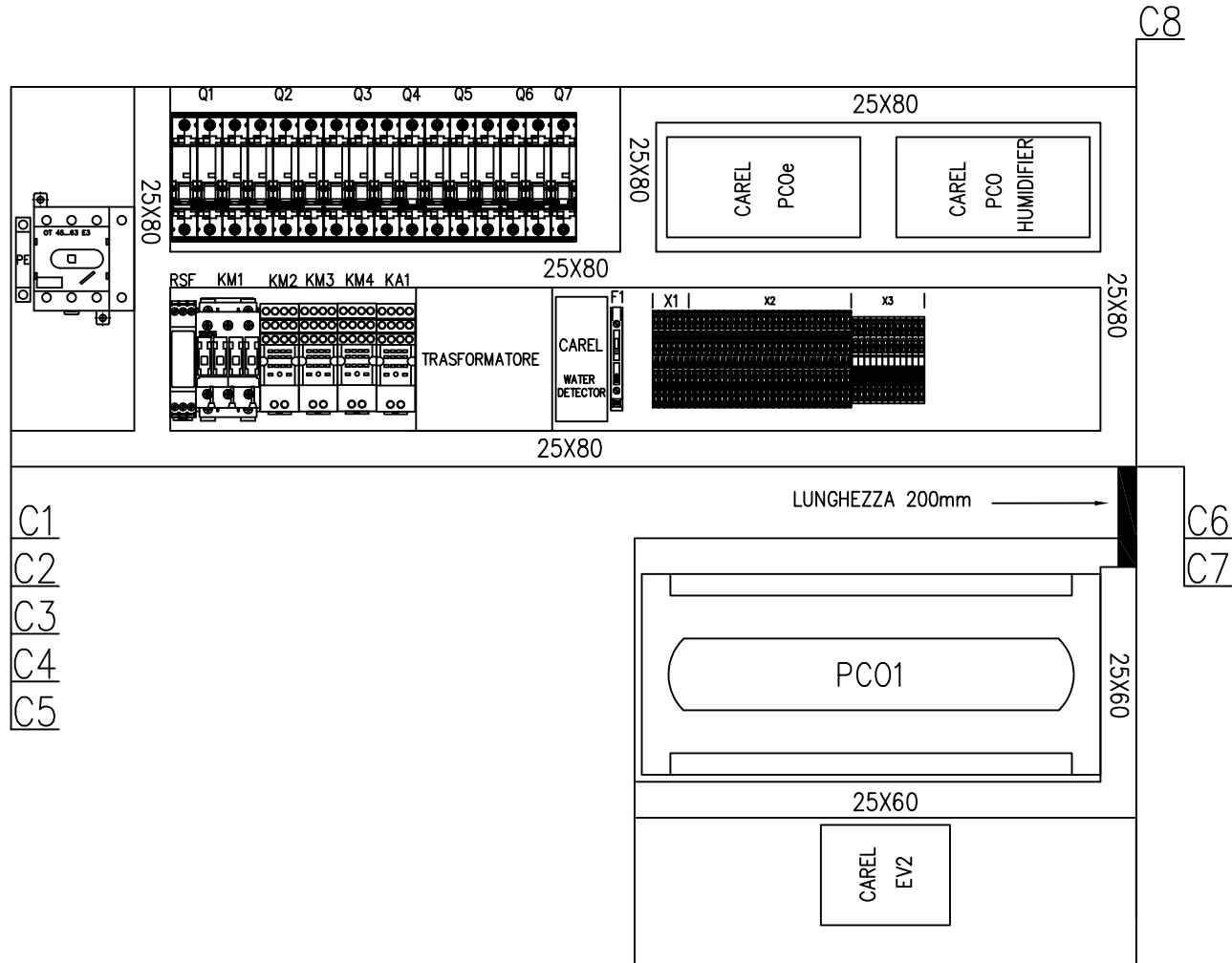

C1
C2
C3
C4
C5

C6
C7

A	REVISIONE GENERALE	10/07/2008	N.C.1	DATE	07/09/2007
B	REVISIONE GENERALE	10/09/2008	N.C.1	DRAW.	N.C.1
C	REVISIONE GENERALE	25/10/2008	N.C.1	CHECK	F.F.1
REV.	MODIFICATIONS	DATE	SIGN.	APPR.	M.M.



HF620C0750

SHEET 27 OF 30
CONTINUE 28

DISTINTA BASE A CUI DEVE ATTENERSI IL QUADRISTA

UBICAZIONE	SIGLA	FUNZIONE	MARCA	CODICE	DESCRIZIONE	QUANTITA'	M.U.	POSIZIONE
	QS	SEZIONATORE	ABB	OT63E4+OHY2AJ+OXS5X85	SEZIONATORE 4P In= 63A + MANIGLIA + ALBERO	1	PCE	
	Q1	PROTEZIONE COMPRESSORE	SIEMENS	5SY6 340-7	INT. AUT. 3P C 40A 6kA	1	PCE	
	Q2	PROTEZIONE VENTILATORE	SIEMENS	5SY6 316-7	INT. AUT. 3P C 16A 6kA	1	PCE	
	Q3	PROTEZIONE RELE' SEQUENZA FASE + TR	SIEMENS	5SY6 306-7	INT. AUT. 3P C 6A 6kA	1	PCE	
	Q4	PROTEZIONE CIRCUITO DI COMANDO	SIEMENS	5SY6 106-7	INT. AUT. 1P C 6A 6KA	1	PCE	
	XPE	MORSETTIERA	PHOENIX	3044212	MORSETTO DI TERRA UT 16-PE	1	PCE	
	X1	MORSETTIERA	PHOENIX	3031157	MORSETTO A MOLLA GRIGIO STTB 1,5	4	PCE	
	X2	MORSETTIERA	PHOENIX	3031157	MORSETTO A MOLLA GRIGIO STTB 1,5	62	PCE	
	RSF	RELE' SEQUENZA FASE	GAVAZZI	DPA51CM44	IL QUADRISTA DEVE PREDISPORRE SOLTANTO I FILI	1	PCE	
	TR	TRSFORNATORE MONOFASE	MARINI	75TM160F	TRASFORMATORE V1=230V / V2=24V S=160VA	1	PCE	
	KM1	ON/OFF COMPRESSORE	SIEMENS	3RT1026-1AB00	TELERUTTORE 11 KW 3P 400V BOB. 24V AC	1	PCE	
	KA1	ON/OFF COMPRESSORE	FINDER	55348024+9474+094.71	RELE' + ZOCCOLO + PONTICELLO DI RITENUTA	1	PCE	
		PIASTRA DI FONDO	HIREF	HF17000756 HF17002296	PIASTRA DI FONDO	1	PCE	
		BARRA DI TERRA			BARRA DI TERRA	1	PCE	

A	REVISIONE GENERALE	10/07/2008	N.C.1	DATE	07/09/2007
B	REVISIONE GENERALE	10/09/2008	N.C.1	DRAW.	N.C.1
C	REVISIONE GENERALE	25/10/2008	N.C.1	CHECK	F.F.1
REV.	MODIFICATIONS	DATE	SIGN.	APPR.	M.M.



HF620C0750

1	2		3		4	5	6	7	8		
UBICAZIONE	SIGLA	FUNZIONE		MARCA	CODICE	DESCRIZIONE		QUANTITA'	M.U.	POSIZIONE	
A		SPINE COMBICOM		PHOENIX	1757019	SPINE COMBICOM 2 POLI CON PASSO DA 5,08mm		1	PCE	A	
		SPINE COMBICOM		PHOENIX	1757022	SPINE COMBICOM 3 POLI CON PASSO DA 5,08mm		6	PCE		
		SPINE COMBICOM		PHOENIX	1757035	SPINE COMBICOM 4 POLI CON PASSO DA 5,08mm		2	PCE		
B		SPINE COMBICOM		PHOENIX	1757048	SPINE COMBICOM 5 POLI CON PASSO DI 5,08mm		6	PCE	B	
		SPINE COMBICOM		PHOENIX	1757051	SPINE COMBICOM 6 POLI CON PASSO DI 5,08mm		1	PCE		
		SPINE COMBICOM		PHOENIX	1757080	SPINE COMBICOM 9 POLI CON PASSO DI 5,08mm		1	PCE		
C											C
D											D
E											E
F											F
A	REVISIONE GENERALE	10/07/2008	N.C.1	DATE	07/09/2007			HF620C0750		SHEET 29 OF 30	
B	REVISIONE GENERALE	10/09/2008	N.C.1	DRAW.	N.C.1					CONTINUE	30
C	REVISIONE GENERALE	25/10/2008	N.C.1	CHECK	F.F.1						
REV.	MODIFICATIONS	DATE	SIGN.	APPR.	M.M.						
1	2		3		4	5	6	7	8		

1	2	3	4	5	6	7	8
OPZIONE UMIDIFICATORE							
A	UBICAZIONE	SIGLA	FUNZIONE	MARCA	CODICE	DESCRIZIONE	QUANTITA' M.U. POSIZIONE
		Q5	PROTEZIONE UMIDIFICATORE	SIEMENS	5SY6306-7/HF40000721	INT. AUT. 3P C 6A 6KA	1 PCE
		KM3	ON/OFF UMIDIFICATORE	FINDER	HF40000250+HF40000246 55348024+9474+09471	RELE' + ZOCCOLO + PONTICELLO DI RITENUTA	1 PCE
OPZIONE RESISTENZE							
B	UBICAZIONE	SIGLA	FUNZIONE	MARCA	CODICE	DESCRIZIONE	QUANTITA' M.U. POSIZIONE
		Q6	PROTEZIONE RESISTENZE	SIEMENS	5SY6220-7/HF40000733	INT. AUT. 2P C20A 6KA	1 PCE
		KM3	ON/OFF RESISTENZE 1* STEP	FINDER	HF40000372+HF40000246 55328024+9474+09471	RELE' + ZOCCOLO + PONTICELLO DI RITENUTA	1 PCE
C		KM4	ON/OFF RESISTENZE 2*STEP	FINDER	HF40000372+HF40000246 55328024+9474+09471	RELE' + ZOCCOLO + PONTICELLO DI RITENUTA	1 PCE
OPZIONE CONTROLLO CONDENSAZIONE							
D	UBICAZIONE	SIGLA	FUNZIONE	MARCA	CODICE	DESCRIZIONE	QUANTITA' M.U. POSIZIONE
		Q7	PROTEZIONE REGOLATORE DI GIRI	SIEMENS	5SY6116-7/HF40000796	INT. AUT. 1P C16A 6KA	1 PCE
OPZIONE POMPA SCARICO CONDENSA							
E	UBICAZIONE	SIGLA	FUNZIONE	MARCA	CODICE	DESCRIZIONE	QUANTITA' M.U. POSIZIONE
		F1	PROTEZIONE POMPA SCARICO CONDENSA	ITALWEBER	0101001	FUSIBILE IN VETRO 5 X 20 In= 1A	1 PCE
		F	MORSETTO PORTA FUSIBILE	PHOENIX	3004100	PER FUSIBILI TIPO G 5 X 20	1 PCE
F	A	REVISIONE GENERALE	10/07/2008	N.C.1	DATE	07/09/2007	 HF620C0750 SHEET 30 OF 30 CONTINUE
	B	REVISIONE GENERALE	10/09/2008	N.C.1	DRAW.	N.C.1	
	C	REVISIONE GENERALE	25/10/2008	N.C.1	CHECK	F.F.1	
	REV.	MODIFICATIONS	DATE	SIGN.	APPR.	M.M.	
	1	2	3	4	5	7	