

A
B
C
D
E
F

A
B
C
D
E
F

SIGN.	Descriptions	Note	
AP1	PRESSOSTATO DI ALTA HIGH PRESSURE P-STAT PRESSOSTAT HAUTE PRESSION DRUCKSCHALTER, HOCHDRUCK PRESOSTATO DE ALTA		
KA3	RELE' ALTA HI-PRESSURE RELAIS RELAIS HAUTE PRESSION RELAIS HOCHDRUCK RELE DE ALTA		
KM1	CONTATTORI COMPRESSORE COMPRESSOR CONTACTORS CONTACTEUR COMPRESSEUR SCHUTZ VENDORCHTER CONTACTOR DEL VENTILADOR		
KM4	CONTATTORE MOTOVENTILATORE FAN MOTOR CONECTOR CONTACTEUR VENTILATEUR VENTILATOR SCHUETZ CONTACTOR DEL MOTOVENTILADOR		
C1 C2	COMPRESSORE COMPRESSOR COMPRESSEUR KOMPRESSOR COMPRESOR		
TR	TRASFORMATORE TRANSFORMER TRANSFORMATEUR TRANSFORMATOR TRANSFORMADOR		
QS	INTERRUTTORE GENERALE MAIN SWITCH INTERRUPTEUR GENERAL HAUPTSCHALTER INTERRUPTOR GENERAL		
M1 M2 M3	MOTOVENTILATORE EVAPORANTE EVAP. FAN MOTOR MOTEUR VENTILATEUR DE EVAP. EVAP.-LUEFTER MOTOVENTILADOR EVAPORADORA		
CN1	COND. DI RIFASAMENTO POWER FACT. CORRECTION COND. CORRECT. COS. PHI KOND. KORR. COS. PHI COND. DE COMP. DE FASES		

SIGN.	Descriptions	Note	
SR1	SERRANDA DAMPER REGISTRE MOTORISIERTA COMPUERTA		
FS1	PRESSOSTATO FLUSSO ARIA AIR FLOW PRESSURE SWITCH PRESSOST. D'ENCRASSEMENT DE FILTRE DRUCKSCHALTER NIEDERDRUCK PRESOSTATO DE BAJA		
SA	TEMPERATURA AMBIENTE INTERNO SHELTER INTERNAL AIR TEMPERATURE SENSOR SONDE TEMPERATURE D'AIR EINTERIOR AUSSERER LUFTEMP.-FILTER SONDA DE TEMPERATURA DE LA DESCARGA DE AIRE		
SM	TEMPERATURA ARIA IN MANDATA DISCHARGE AIR TEMPERATURE SONDE DE TEMPERATURE ZULLUFTTEMPERATUR TEMP. DE LA DISCARGA DE AIRE		
BP1	PRESSOSTATO DI BASSA LOW PRESSURE P-STAT PRESSOSTAT BASSE PRESSION DRUCKSCHALTER NIEDEDRUCK PRESOSTATO DE BAJA		
K1	REGOLATORE DI VELOCITA' SPEED CONTROLLER REGULATEUR DE VITESSE VENTILATOR/DREHZAHLEGLER REGULADOR VELOCIDAD		
FS2	PRESSOSTATO FILTRI SPORCHI CLOGGED FILTER PRESSURE SWITCH PRESSOSTAT D'ENCRASSEMENT DE FILTRE DRUCKSCHALTER. FILTERVERSCHMUTZUNG PRESOSTATO FILTROS SUCIOS		

SIGN.	Descriptions	Note	
Q5	INTERR. VENTILATORI SWITCH FANS INTERR. VENT. AUTOMATISCHER VENT. INTERR. VENT.		
	INTERR. RES.		
Q7	INTERR. AUSILIARI SWITCH AUX INTERR. AUS. AUTOMATISCHER AUX INTERR. AUS.		
TP3 TP4 TP5	TERMICHE VENTILATORI THERMAL PROTECTIONS FANS TERMICHE VENTILATORI TERMICHE VENTILATORI		

DATE	09/09/2006
DRAW.	P.M.
CHECK	P.M.
REV.	MODIFICATIONS
DATE	SIGN.
APPR.	M.M.



HF620D0559

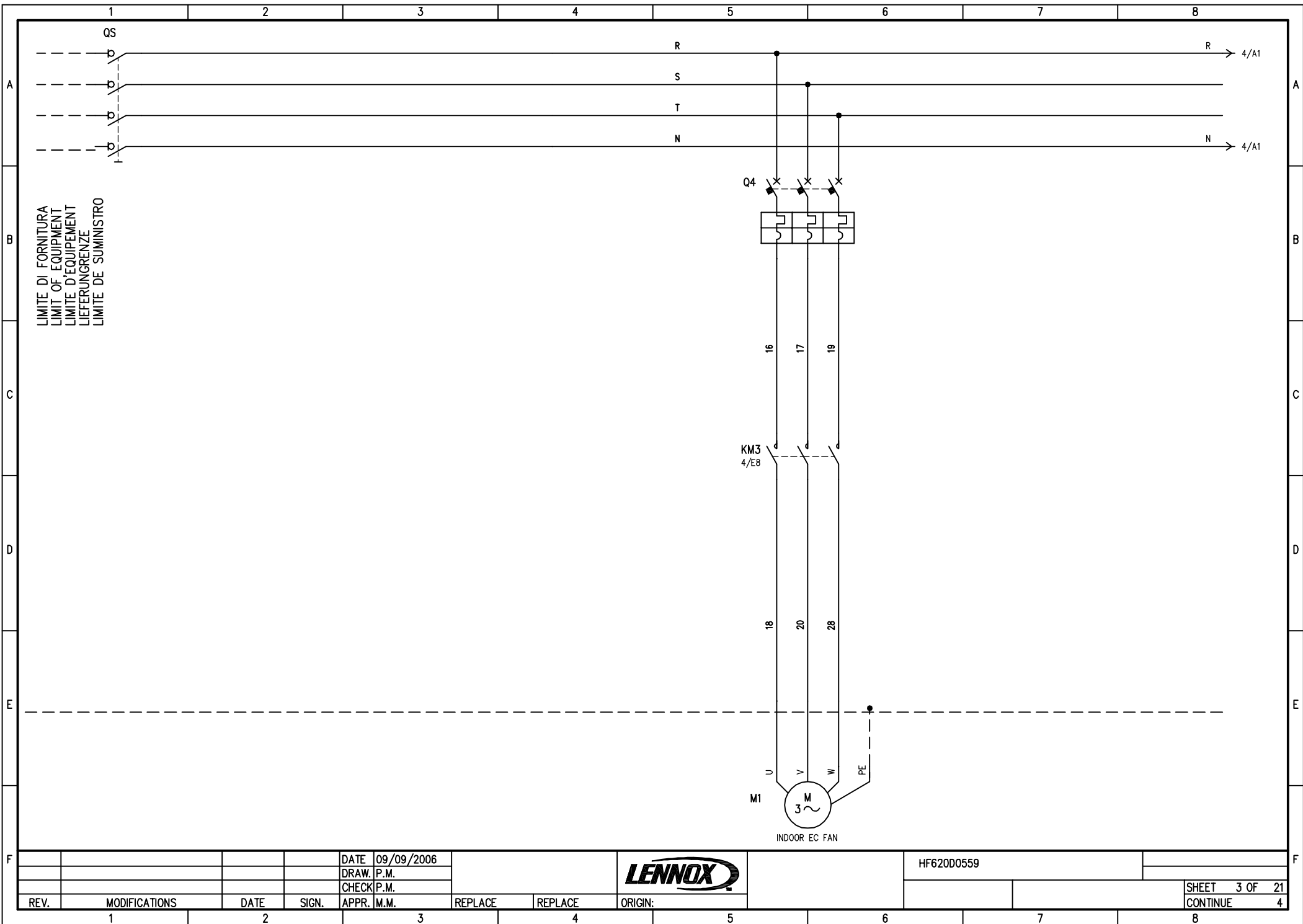

LIMITE DI FORNITURA
 LIMIT OF EQUIPMENT
 LIMITE D'EQUIPEMENT
 LIEFERUNGRENZE
 LIMITE DE SUMINISTRO

DATE 09/09/2006

DRAW. P.M.

CHECK P.M.

APPR. M.M.



HF620D0559

REV.	MODIFICATIONS	DATE	SIGN.	APPR.	M.M.	REPLACE	REPLACE	ORIGIN:
1		2			3			5

SHEET 3 OF 21

CONTINUE 4

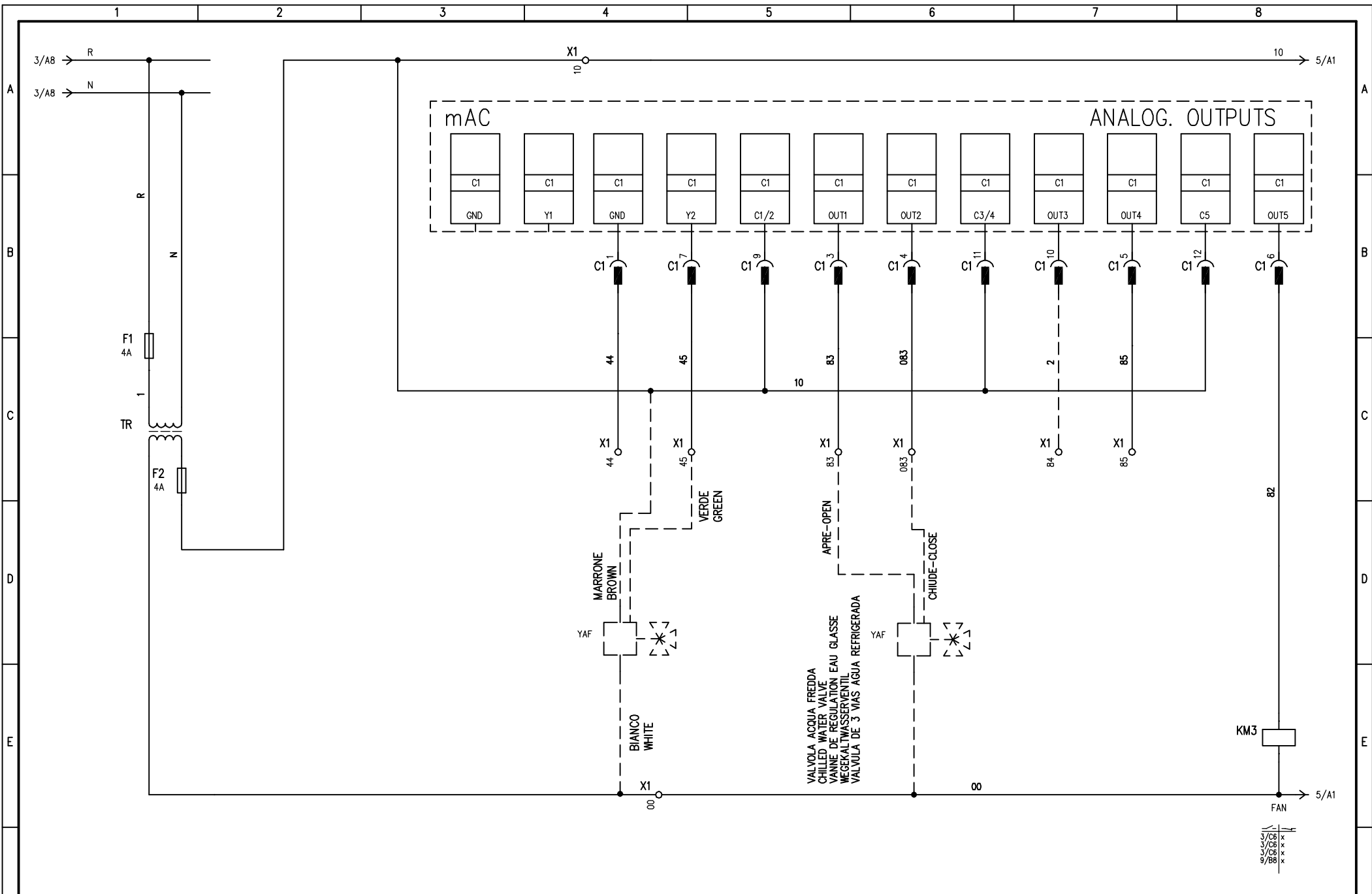

REV.	MODIFICATIONS	DATE	SIGN.	APPR.	M.M.	REPLACE	REPLACE	ORIGIN:	HF620D0559	SHEET 4 OF 21
1		2		3		4		5		CONTINUE 5



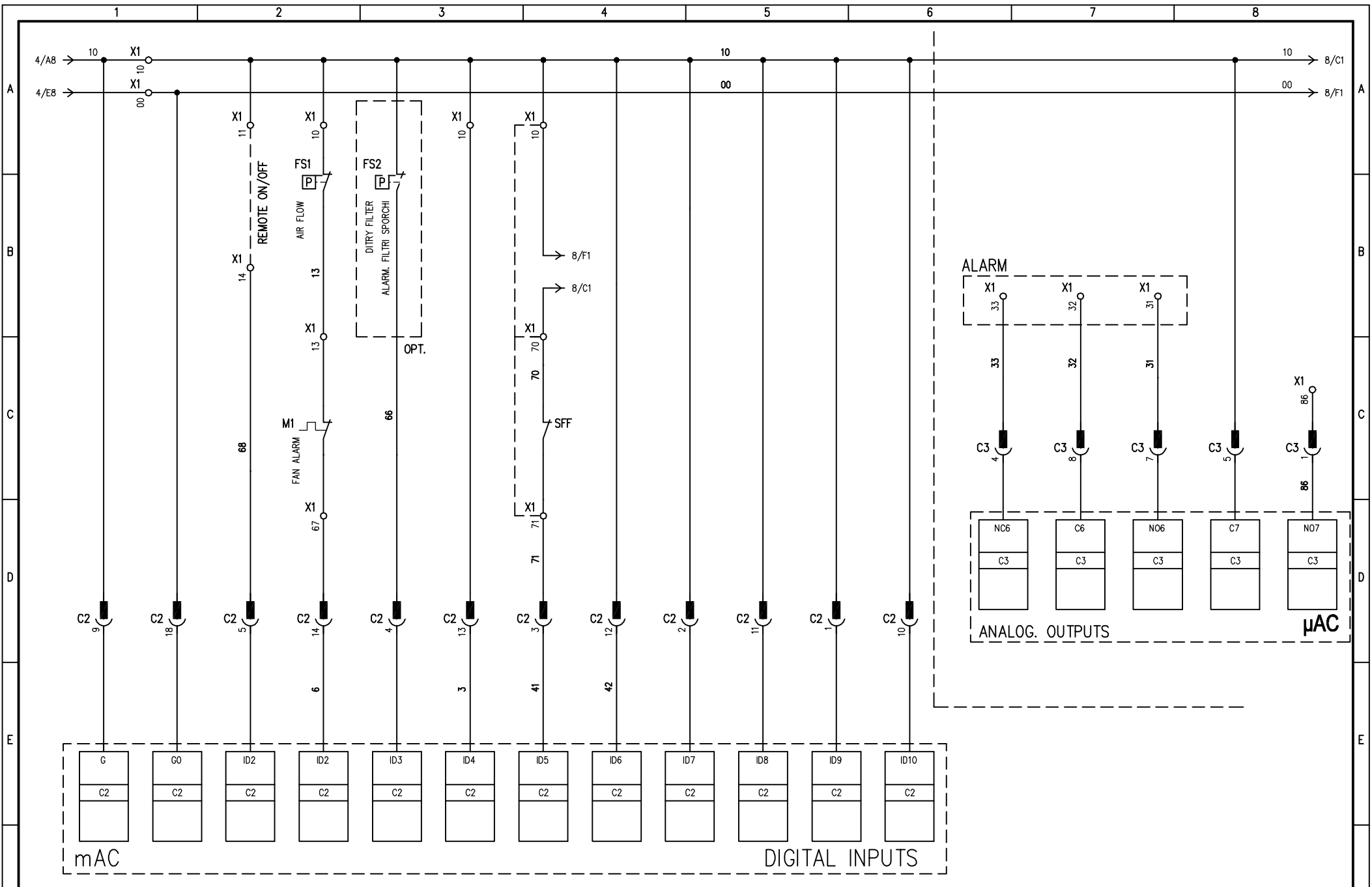

DATE 09/09/2006		DRAW. P.M.		LENNOX		HF620D0559									
CHECK P.M.															
REV.	MODIFICATIONS	DATE	SIGN.			APPR. M.M.	REPLACE	REPLACE	ORIGIN:	SHEET 5 OF 21					
1		2		3		4		5		6		7		8	CONTINUE 6

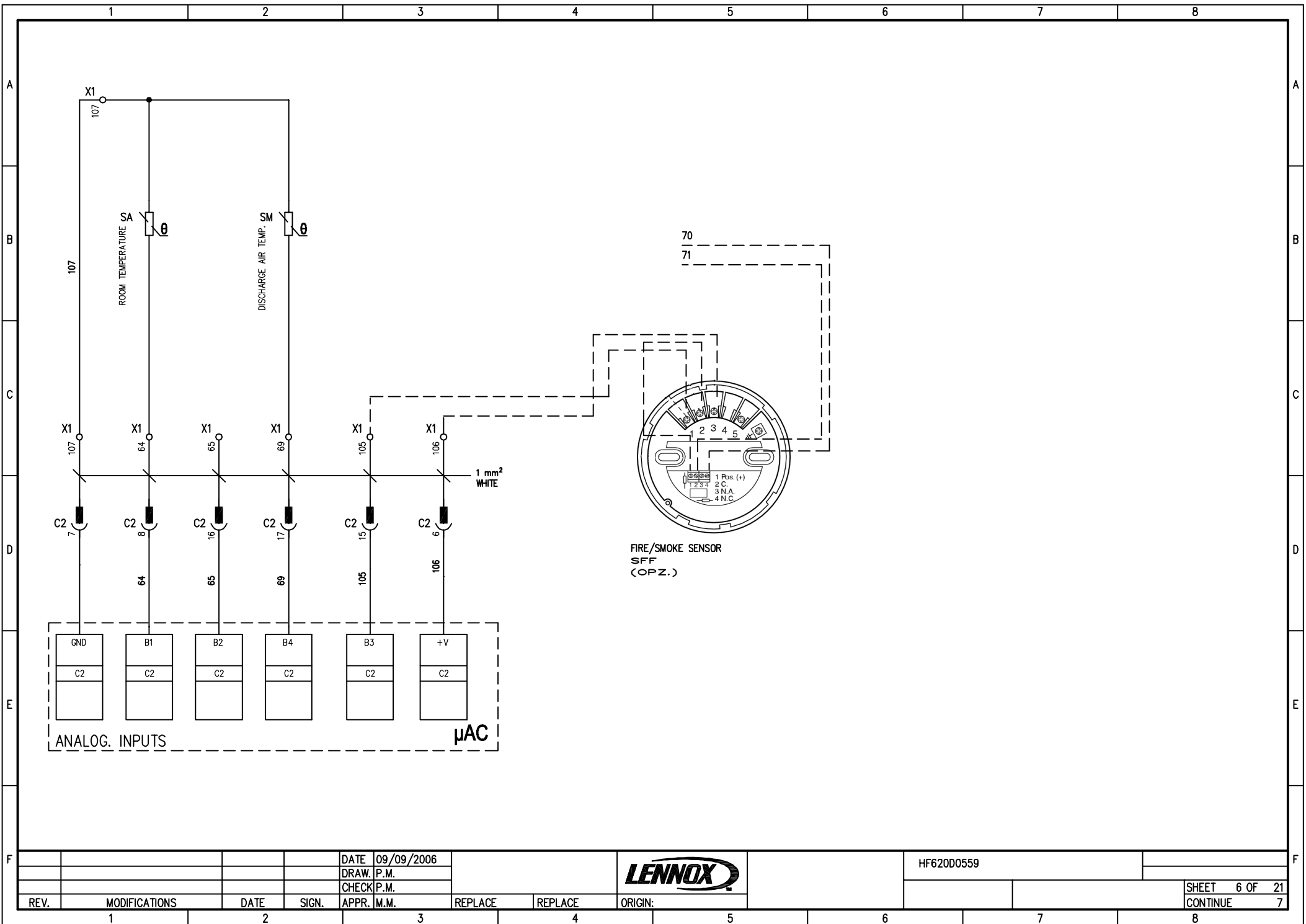

DATE 09/09/2006
 DRAW. P.M.
 CHECK P.M.
 APPR. M.M.



HF620D0559

1

2

3

4

5

6

7

8

A

A

B

B

C

C

D

D

E

E

F

F

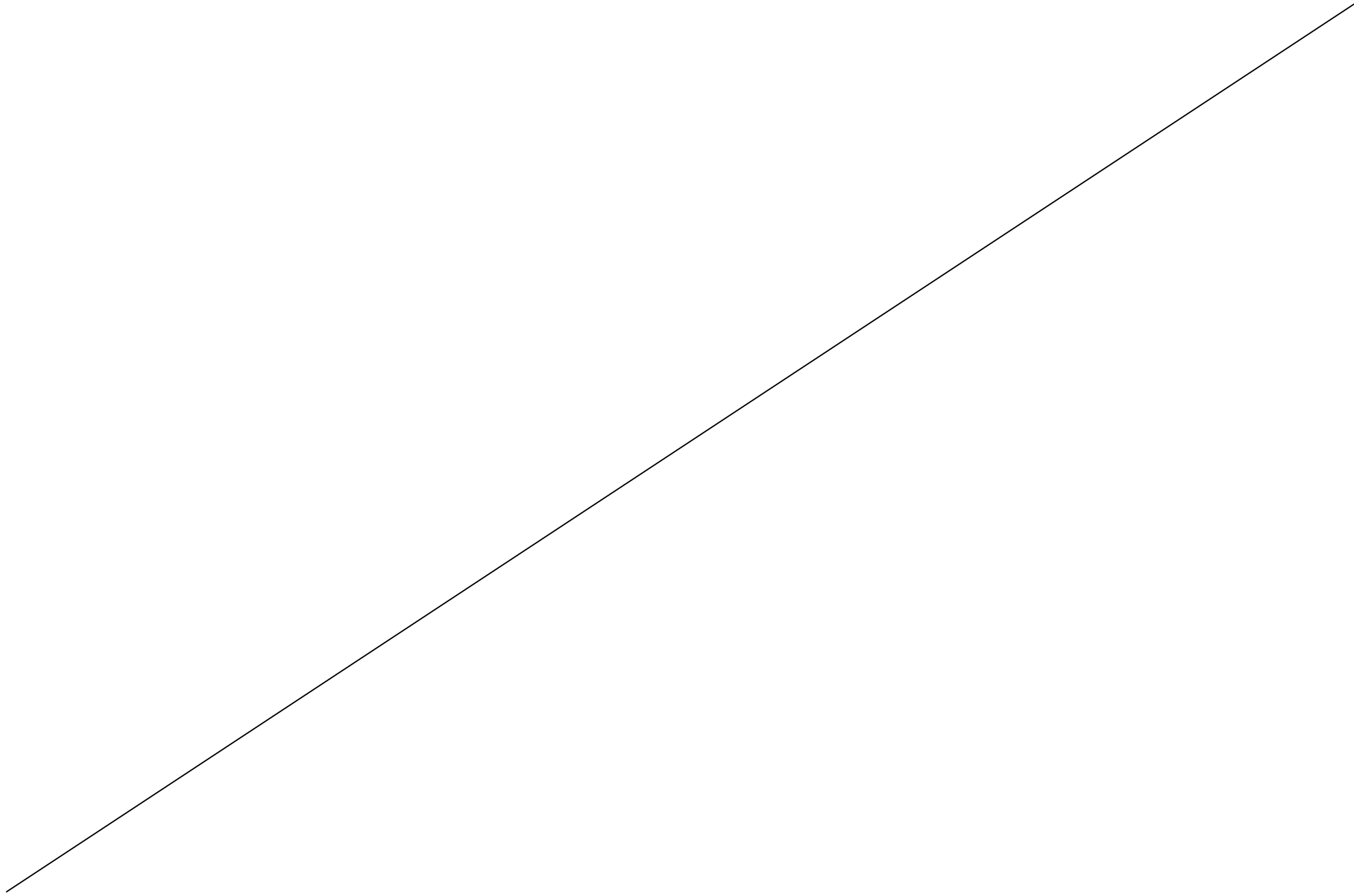

DATE 09/09/2006

DRAW. P.M.

CHECK P.M.



HF620D0559

REV.	MODIFICATIONS	DATE	SIGN.	APPR.	M.M.	REPLACE	REPLACE	ORIGIN:						SHEET 7 OF 21	CONTINUE 8
------	---------------	------	-------	-------	------	---------	---------	---------	--	--	--	--	--	---------------	------------

1

2

3

4

5

6

7

8

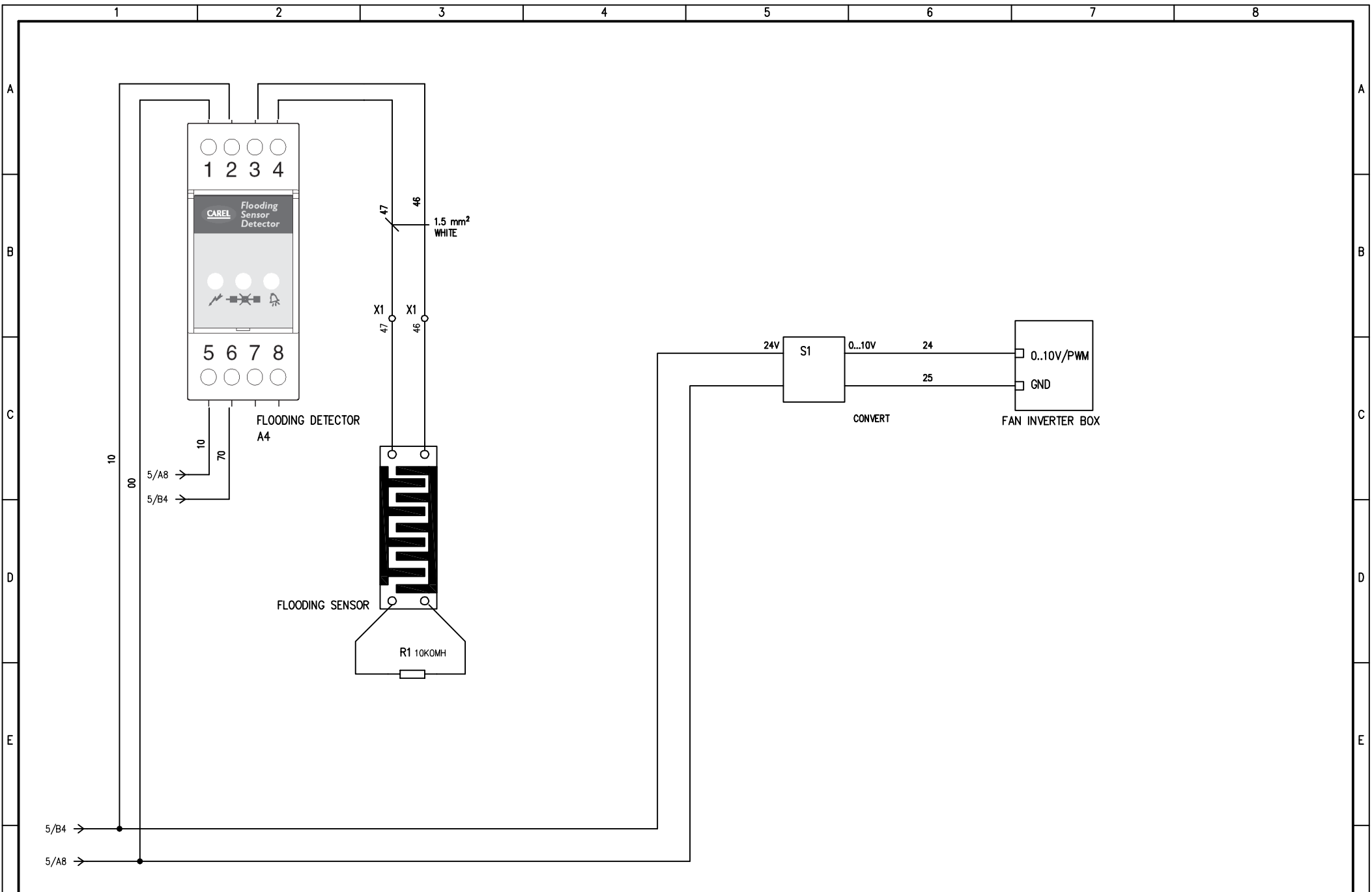

				DATE	09/09/2006			LENNOX		HF620D0559			
				DRAW.	P.M.								
				CHECK	P.M.								
REV.	MODIFICATIONS	DATE	SIGN.	APPR.	M.M.	REPLACE	REPLACE	ORIGIN:			SHEET 8 OF 21		
1		2		3		4		5	6	7	8	CONTINUE 9	



F3
OPZIONAL

114

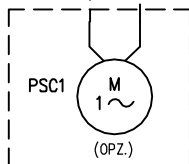

POMPA SCARICO CONDENZA
CONDENSATE DRAIN PUMP
POMPE A EAU CONDENSEUY
KONDENSATWASS PUMPE
BOMBA DESEGUE CONDEN.

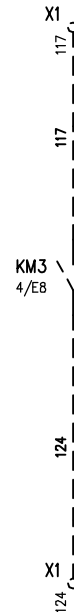

INTERNAL NOTE: INSTALLARE MORSETTI

SEGNALAZIONE DELLO STATO DELL'UNITA' (OPZ.)
UNIT STATUS SIGNAL (OPT.)
ETAT DES SIGNAUX DE L'UNITE' (OPT.)
STATUSMELDEKONTAKT (ZUB.)
SENALIZACION DEL ESTADO DE LA UNIDAD (OPC.)

DATE 09/09/2006

DRAW. P.M.

CHECK P.M.



HF620D0559

REV. MODIFICATIONS DATE SIGN. APPR. M.M.

REPLACE REPLACE

ORIGIN:

SHEET 9 OF 21

CONTINUE 10

MORSETTIERA
 TERMINAL STRIP
 BORNIER
 KLEMMLEISTE

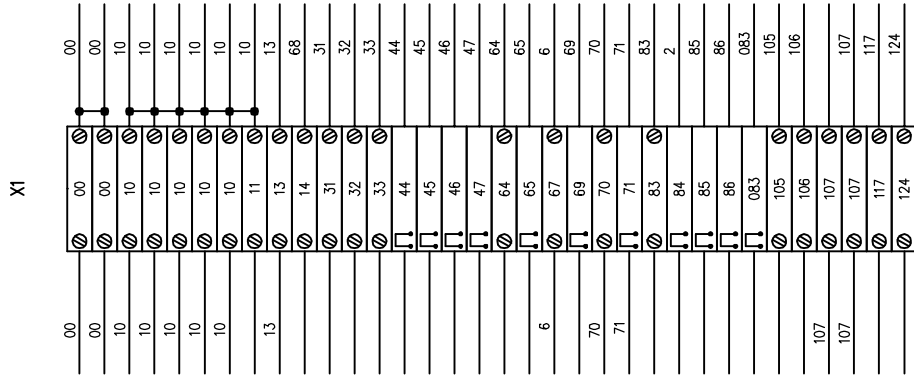

CONVERT

DIRTY FILTER

DIRTY FILTER

FAN ALARM

FAN ALARM



HF620D0559

DATE 09/09/2006
 DRAW. P.M.
 CHECK P.M.

LAYOUT BOARD

CONNETTORI

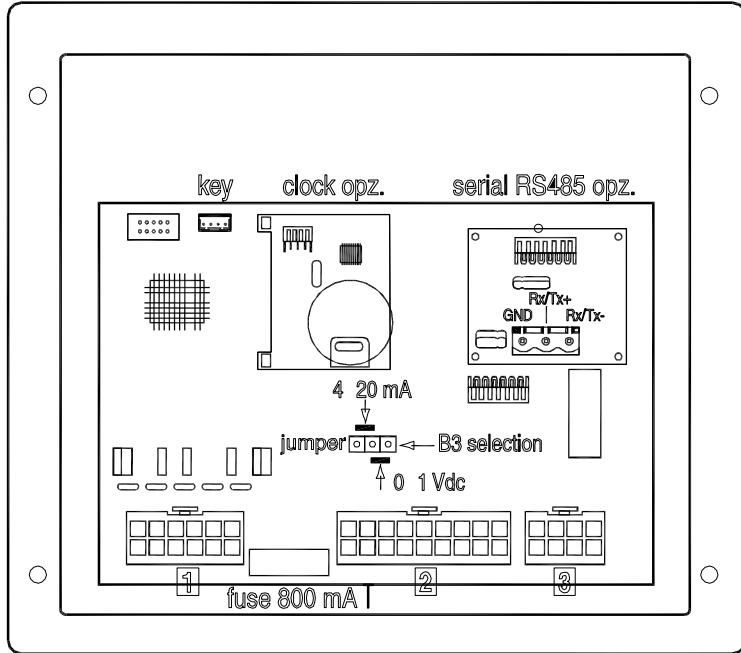

C1

Pin	Filo	Posizione
1	44	4/B4
2	128	4/B3
3	83	4/B5
4	083	4/B6
5	85	4/B7
6	82	4/B8
7	45	4/B5
8	129	4/B4
9	10	4/B5
10	84	4/B7
11	10	4/B6
12	10	4/B8

C2

Pin	Filo	Posizione
1	10	3/E4
1	10	3/E4
2	63	5/D5
3	41	5/D4
4	66	5/D3
5	68	5/D2
6	106	6/D3
7	107	6/D1
8	64	6/D1
9	10	5/D1
10	10	5/D6
11	10	5/D5
12	42	5/D4
13	61	5/D3
14	67	5/D2
15	105	6/D3
16	65	6/D2
17	69	6/D2
18	00	5/D1

C3

Pin	Filo	Posizione
1	86	5/C8
4	33	5/C6
5	10	5/C8
7	31	5/C7
8	32	5/C7

LAYOUT MOD.080/110

PIASTRA DI FONDO NS. COD. HF17000909

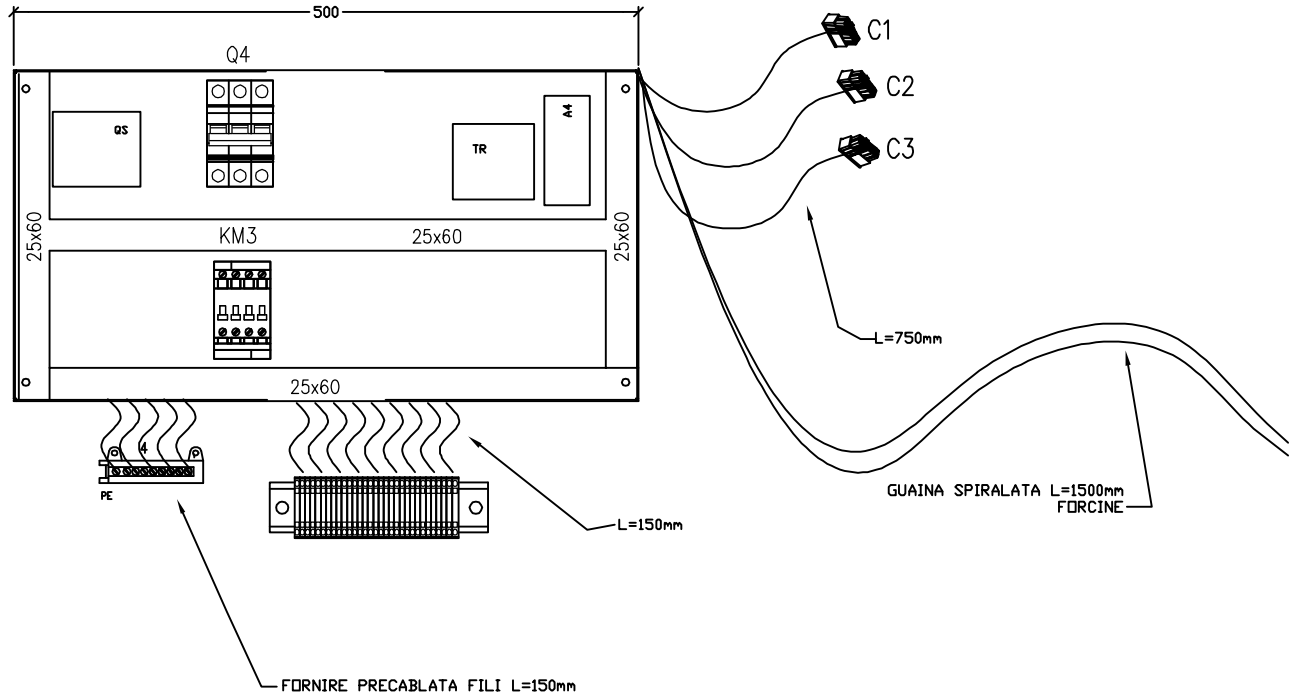

**LASCARE LATO INFERIORE DEL SEZIONATORE
LIBERO PER INGRESSO LINEA**

REV.	MODIFICATIONS	DATE	SIGN.	APPR.	M.M.	REPLACE	REPLACE	ORIGIN:
1								
2								
3								
4								
5								
6								
7								
8								

DATE 09/09/2006
DRAW. P.M.
CHECK P.M.



HF620D0559

LAYOUT 140-160

PIASTRA DI FONDO NS. COD. HF17000756

COPRIRE CON LASTRA DI PLEXIGLASS
NS. COD. HF55000040

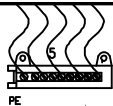
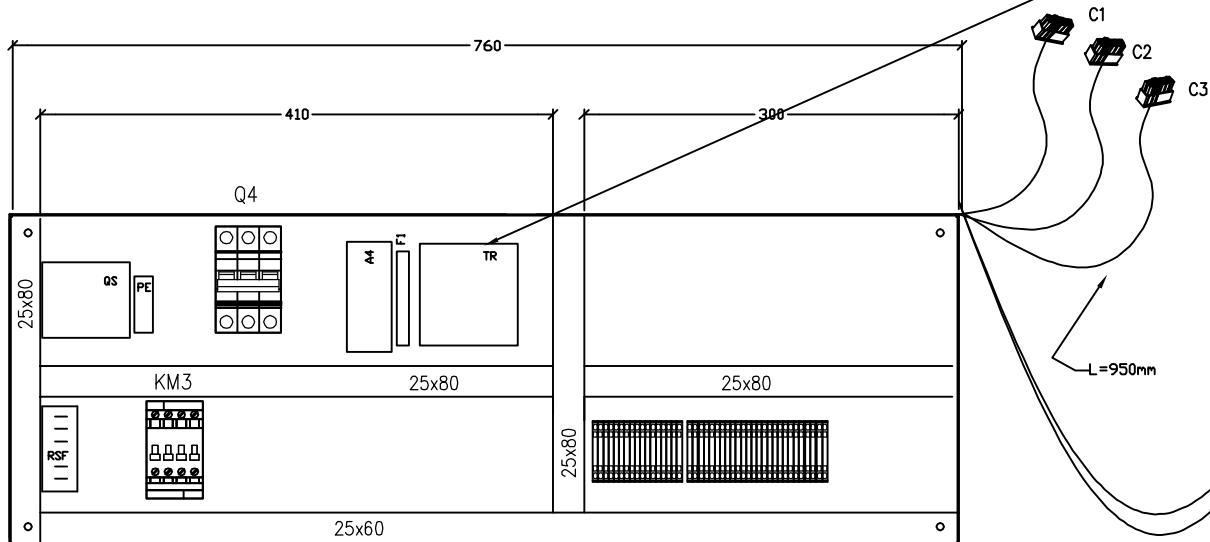
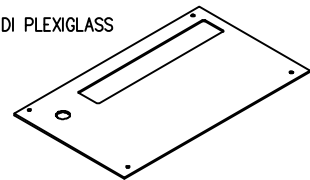

FORNIRE PRECABLATA FILI L=150mm



**LASCARE LATO INFERIORE DEL SEZIONATORE
LIBERO PER INGRESSO LINEA**

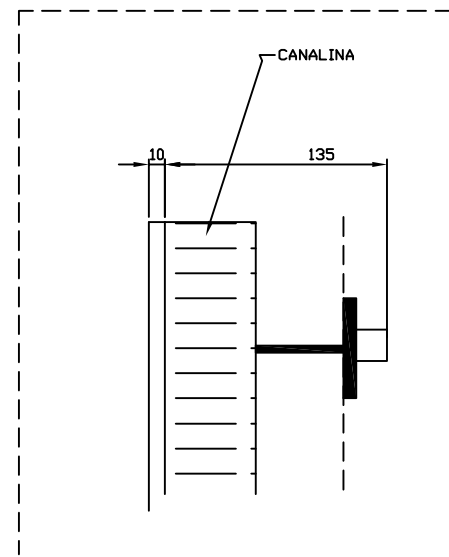

				DATE	09/09/2006				HF620D0559			
				DRAW.	P.M.							
				CHECK	P.M.							
REV.	MODIFICATIONS	DATE	SIGN.	APPR.	M.M.	REPLACE	REPLACE	ORIGIN:			SHEET 13 OF 21	
1		2		3		4		5			CONTINUE 14	

LAYOUT 200/230

COPRIRE QUESTA PARTE CON LASTRA DI POLICARBONATO
ALATEZZA UTILE FILO MANOVRA B/P H=135max

COPRIRE CON LASTRA DI PLEXIGLASS
NS. COD. HF55000040

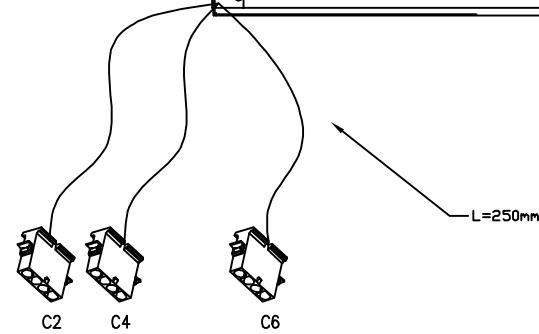
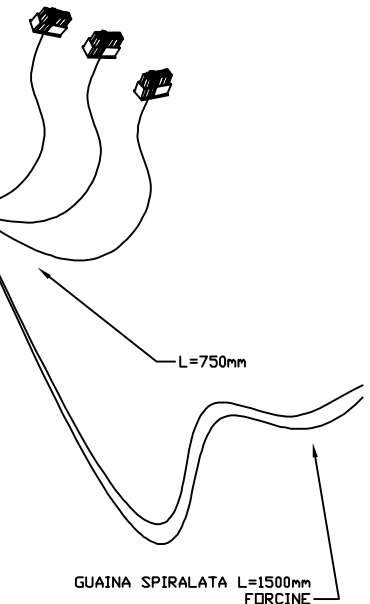
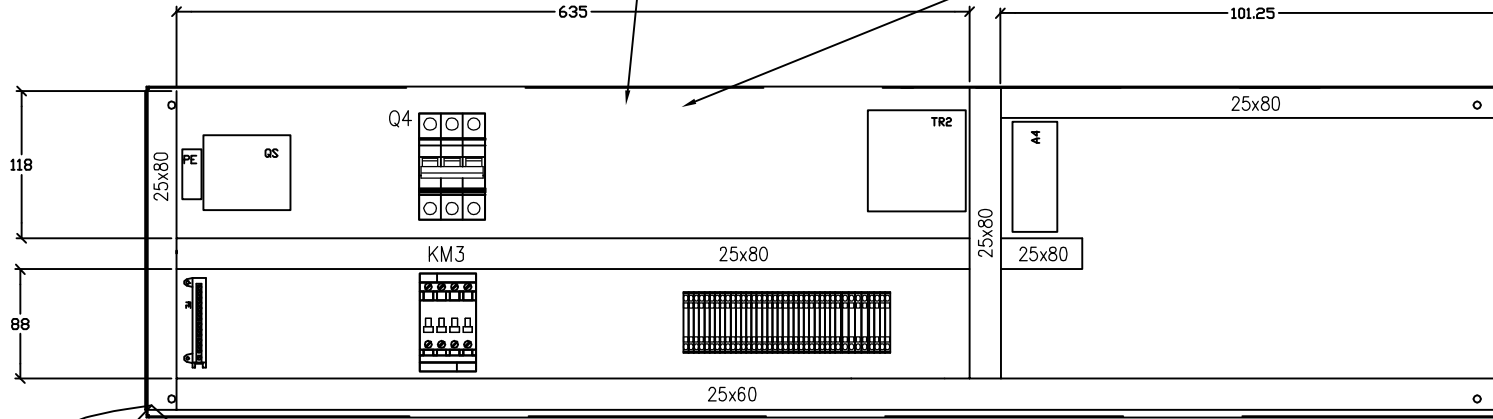

**LASCARE LATO INFERIORE DEL SEZIONATORE
LIBERO PER INGRESSO LINEA**

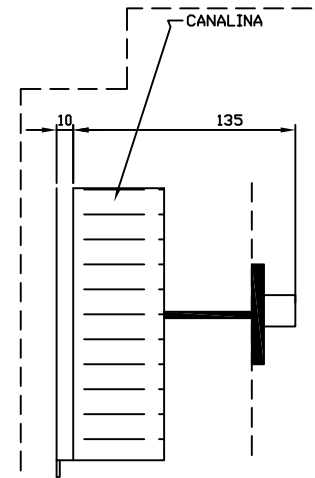
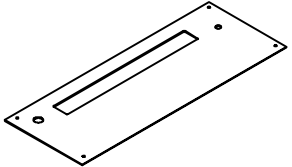
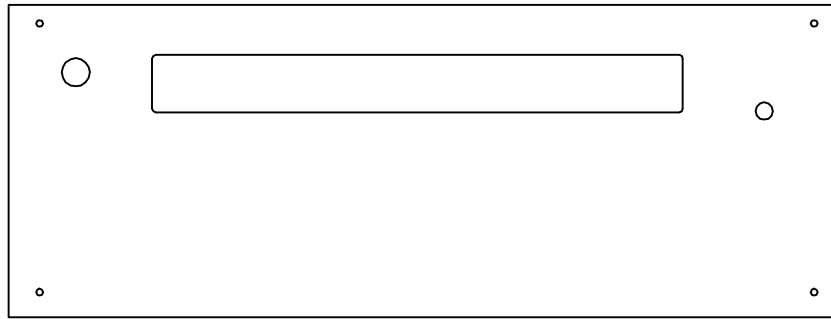

DATE	09/09/2006			LENNOX	HF620D0559		
DRAW.	P.M.						
CHECK	P.M.						
REV.	MODIFICATIONS	DATE	SIGN.	APPR. M.M.	REPLACE	REPLACE	ORIGIN:
1		2		3		4	5
							6
							7
							8

	1	2	3	4	5	6	7	8	
A									A
B									B
C									C
D									D
E									E
F									F
				DATE	09/09/2006			HF620D0559	
				DRAW.	P.M.				
				CHECK	P.M.				
REV.	MODIFICATIONS	DATE	SIGN.	APPR.	M.M.	REPLACE	REPLACE	ORIGIN:	
1		2		3		4		5	
									SHEET 15 OF 21 CONTINUE 16

1

2

3

4

5

6

7

8

A

A

B

B

C

C

D

D

E

E

F

F

				DATE	09/09/2006				HF620D0559		
				DRAW.	P.M.						
				CHECK	P.M.						
REV.	MODIFICATIONS	DATE	SIGN.	APPR.	M.M.	REPLACE	REPLACE	ORIGIN:			SHEET 16 OF 21
1		2		3		4		5	6	7	8 CONTINUE 17

1		2		3		4		5		6		7		8	
080/110	Ref-mark	Function		Technical data		Item code		Description				Amount	M.U.	Position	
	EV1											1		7/B05	
	EV2											1		7/B05	
	F1/2/3				4AF					FUSIBILE 5X20		1	PCE	3/D08	
	KM3	EVAP. FANS		SIEMENS/AEG		3RT1016-1AB01		TEL. AEG LS4.10 24V				1	PCE	4/E07	
REV.	MODIFICATIONS	DATE	SIGN.	APPR.	M.M.	REPLACE	REPLACE	ORIGIN:	LENNOX			HF620D0559	SHEET 18 OF 21 CONTINUE 19		
1		2		3		4		5	6	7	8				

1	2		3	4	5	6	7	8	
140...230	Ref-mark	Function	Technical data	Item code	Description	Amount	M.U.	Position	
	EV1					1		7/B05	
	EV2					1		7/B05	
	F1/2/3		4AF		FUSIBILE 5X20	1	PCE	3/D08	
	KM3	EVAP. FANS	SIEMENS/AEG	3RT1016-1AB01	TEL. AEG LS4.10 24V	1	PCE	4/E07	
REV.		MODIFICATIONS	DATE	SIGN.	APPR.	M.M.	REPLACE	REPLACE	ORIGIN:
1									
2									
3									
4									
5									
6									
7									
8									

A

A

B

B

C

C

D

D

E

E

F

F

DATE 09/09/2006

DRAW. P.M.

CHECK P.M.



HF620D0559

SHEET 20 OF 21

CONTINUE 21

