

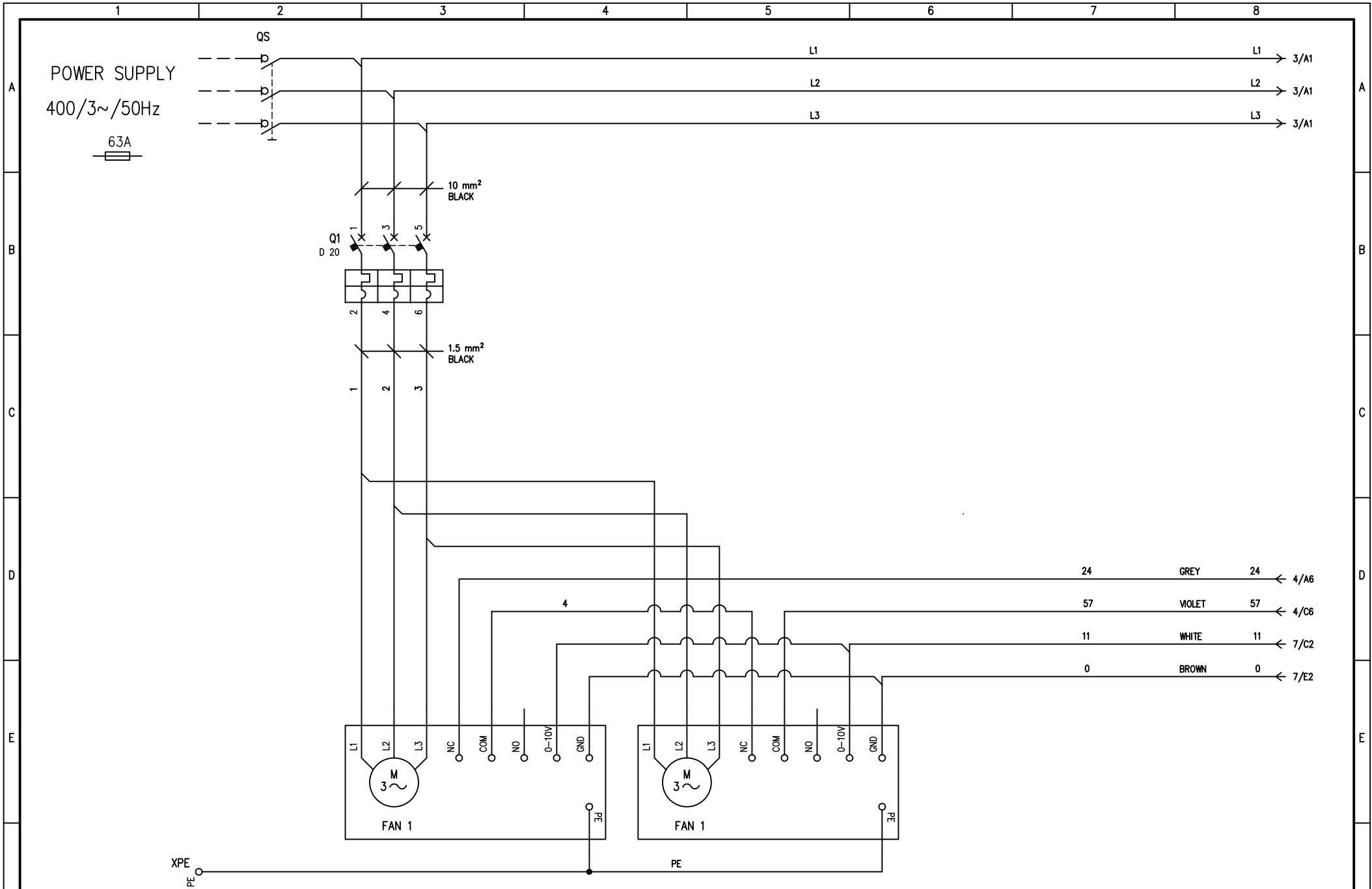



model:	DHCDR1800			
power supply:	400V 3~ 50Hz			
auxiliary supply:	24VAC			
	ONLY COLD	WITH HEATERS	WITH HUMIDIFIER	WITH HEATERS AND HUMIDIFIER
MAX POWER	5,8 KW	27,4 KW	11,8 KW	33,4 KW
FLA	9,4 A	40,6 A	19,6 A	49,1 A

REV.	MODIFICATIONS	DATE	SIGN.	APPR.	M.M.	REPLACE	REPLACE	ORIGIN:	LENNOX	HF620C0719	SHEET 1 OF 21	CONTINUE 2
1		2		3		4		5	6	7	8	



				DATE 03/10/2007						
				DRAW. N.C.1						
				CHECK F.F.1						
REV.	MODIFICATIONS	DATE	SIGN.	APPR. M.M.	REPLACE	REPLACE	ORIGIN:	HF620C0719	SHEET 2 OF 21	
1		2		3					CONTINUE 3	

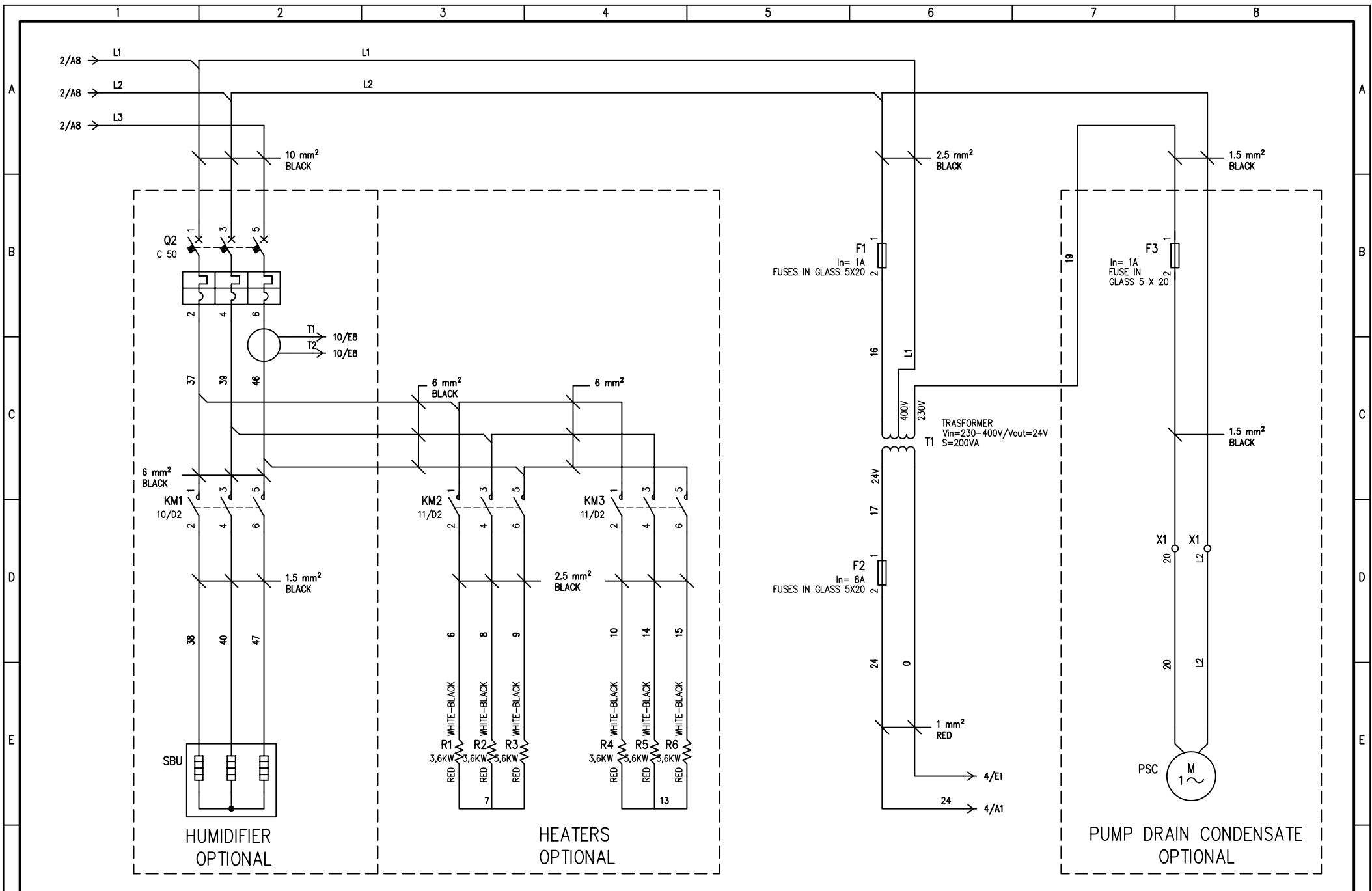

DATE 03/10/2007
 DRAW. N.C.1
 CHECK F.F.1
 APPR. M.M.



HF620C0719

SHEET 3 OF 21
 CONTINUE 4

REV.	MODIFICATIONS	DATE	SIGN.
1		2	

REPLACE	REPLACE	ORIGIN:
3	4	5

F

F

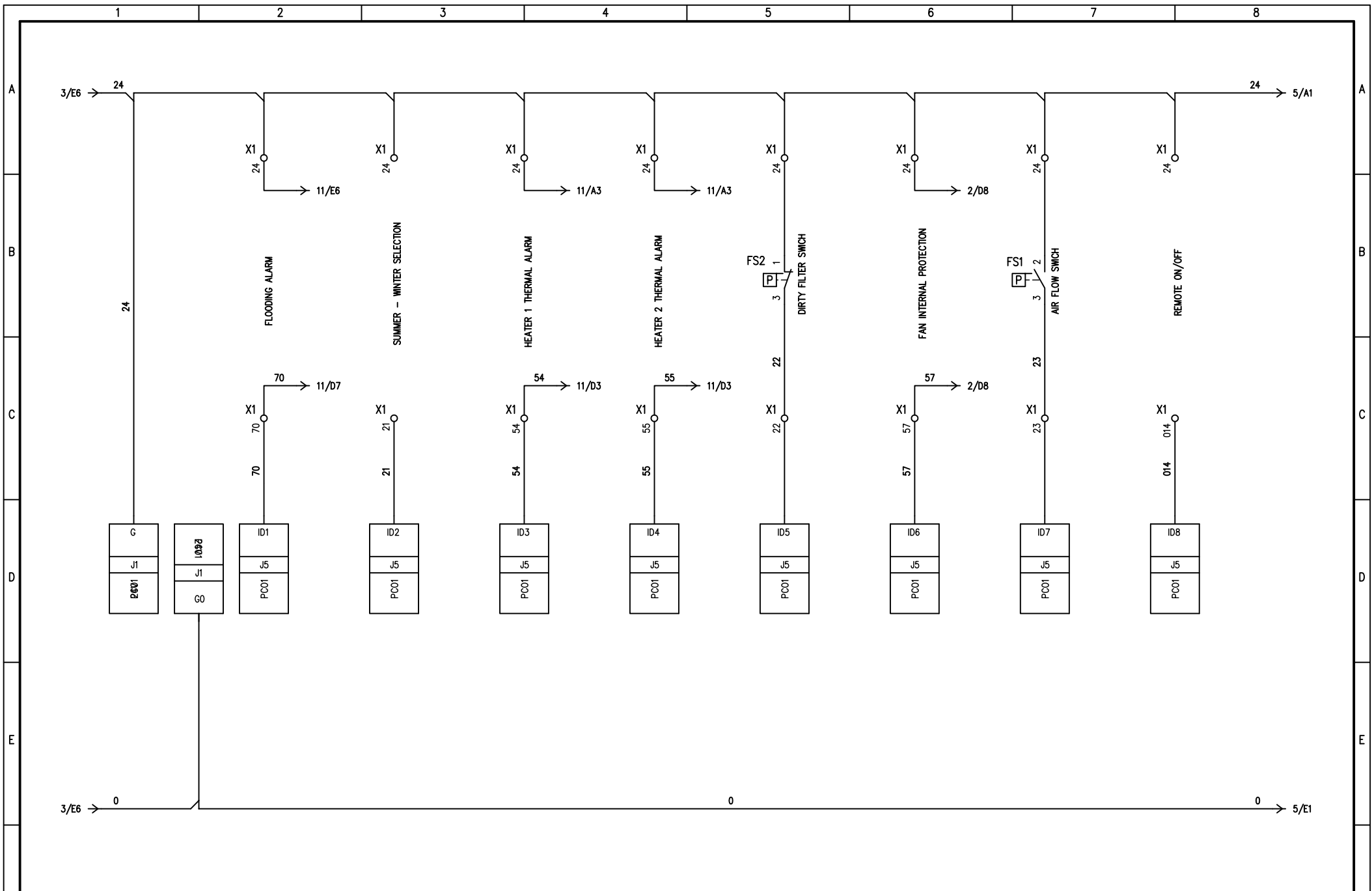

				DATE	03/10/2007										
				DRAW.	N.C.1										
				CHECK	F.F.1										
REV.	MODIFICATIONS	DATE	SIGN.	APPR.	M.M.	REPLACE	REPLACE	ORIGIN:			HF620C0719		SHEET 4 OF 21		
1		2		3		4		5		6		7		8	CONTINUE 5

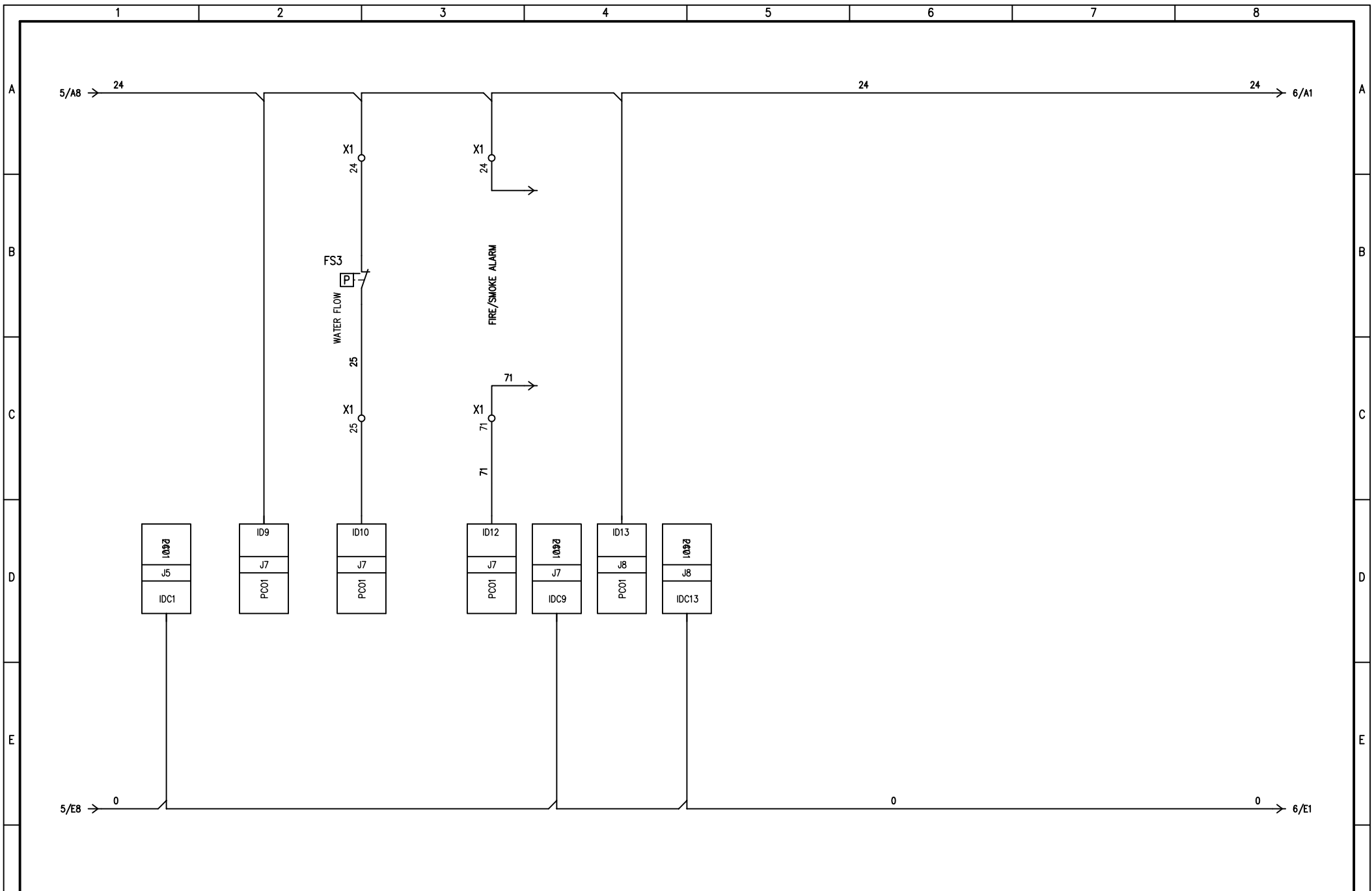

				DATE	03/10/2007							
				DRAW.	N.C.1							
				CHECK	F.F.1							
REV.	MODIFICATIONS	DATE	SIGN.	APPR.	M.M.	REPLACE	REPLACE	ORIGIN:			HF620C0719	SHEET 5 OF 21
1		2		3		4		5	6	7	8	CONTINUE 6

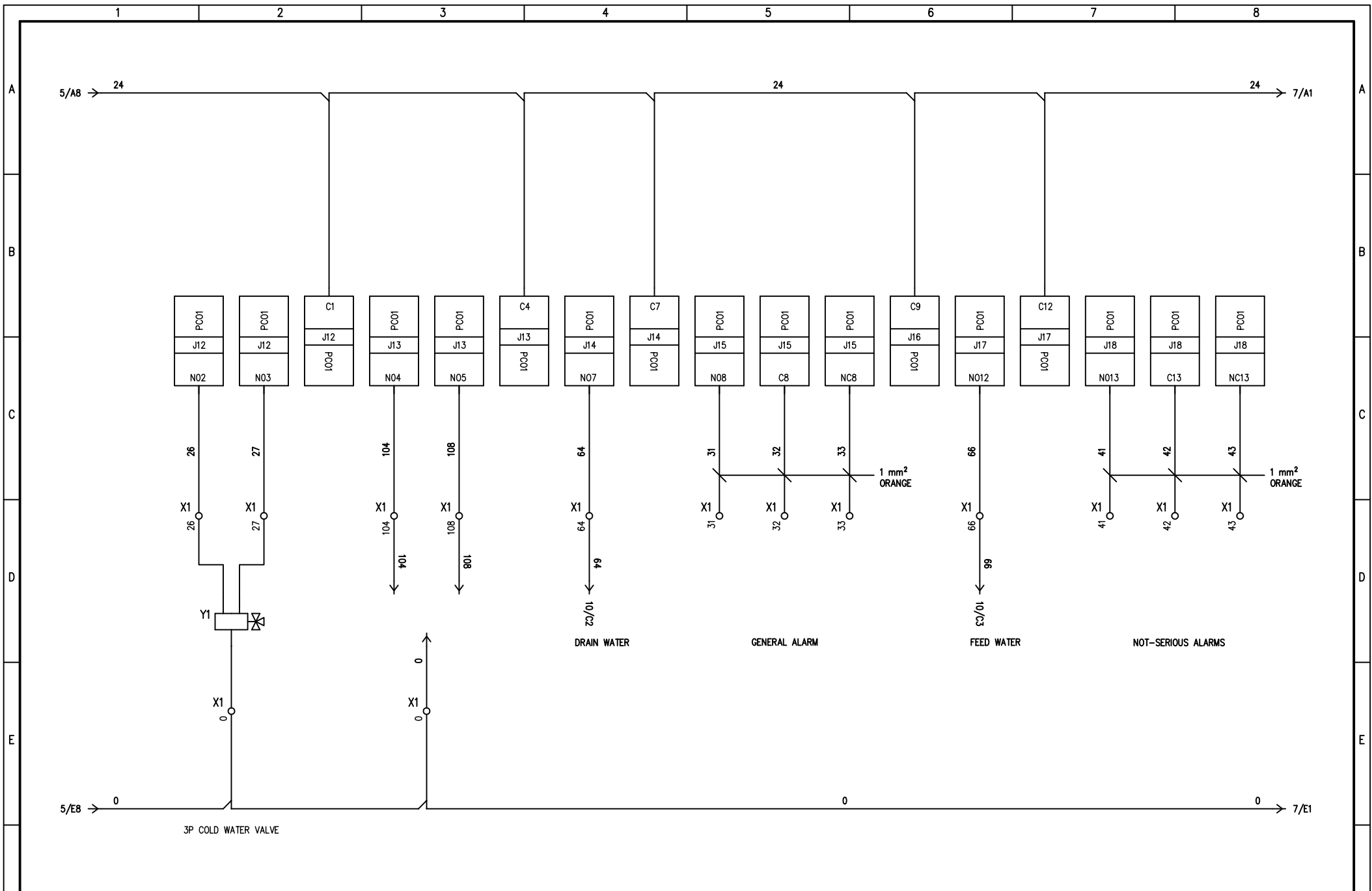

				DATE 03/10/2007								
				DRAW. N.C.1								
				CHECK F.F.1								
REV.	MODIFICATIONS	DATE	SIGN.	APPR. M.M.	REPLACE	REPLACE	ORIGIN:	HF620C0719		SHEET 6 OF 21		
1		2		3		4		5	6	7	8	
										CONTINUE 7		

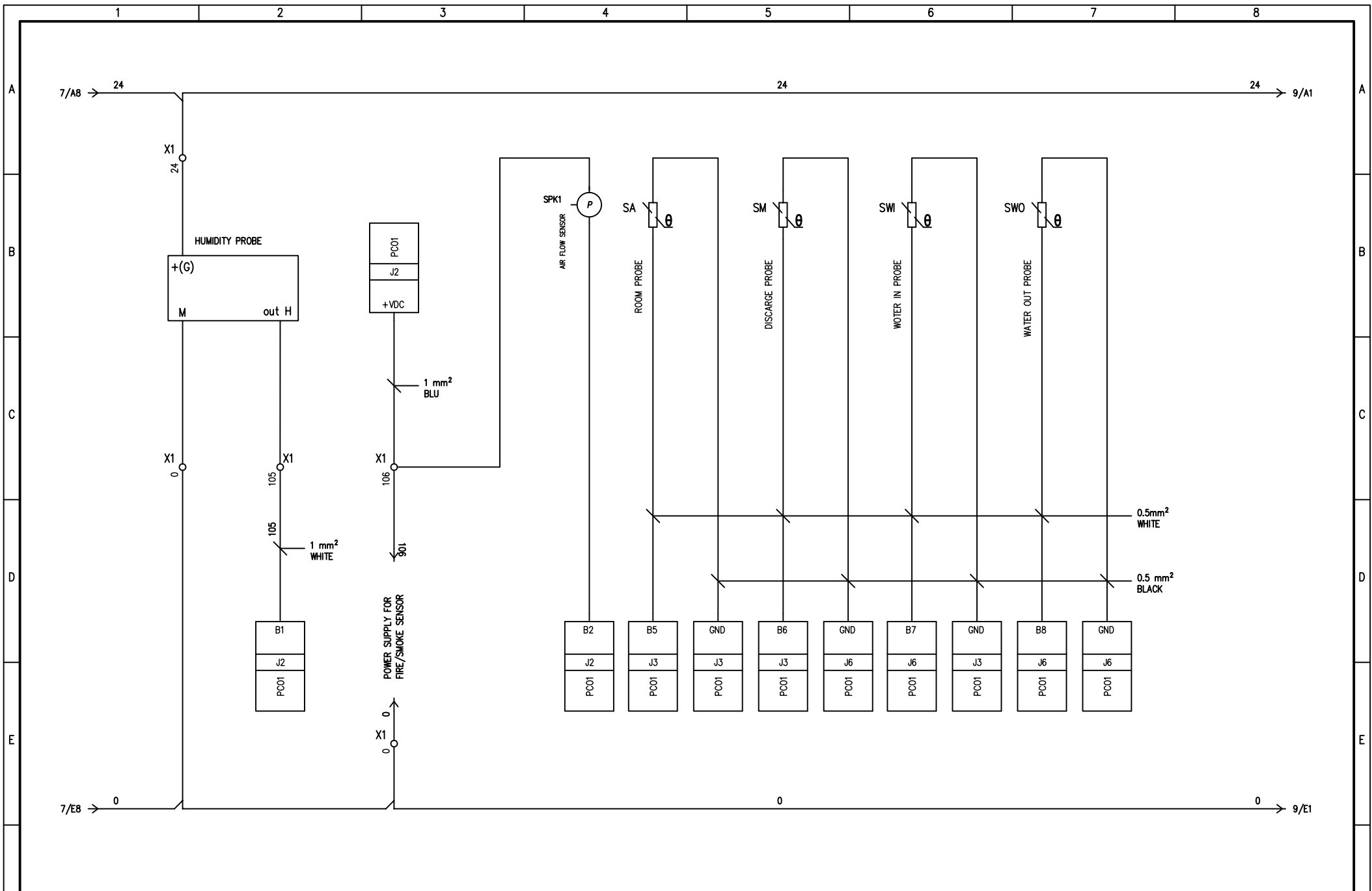

DATE 03/10/2007
 DRAW. N.C.1
 CHECK F.F.1
 APPR. M.M.



HF620C0719

SHEET 8 OF 21
 CONTINUE 9

REV.	MODIFICATIONS	DATE	SIGN.
1		2	

REPLACE	REPLACE	ORIGIN:
3	4	5

F

F

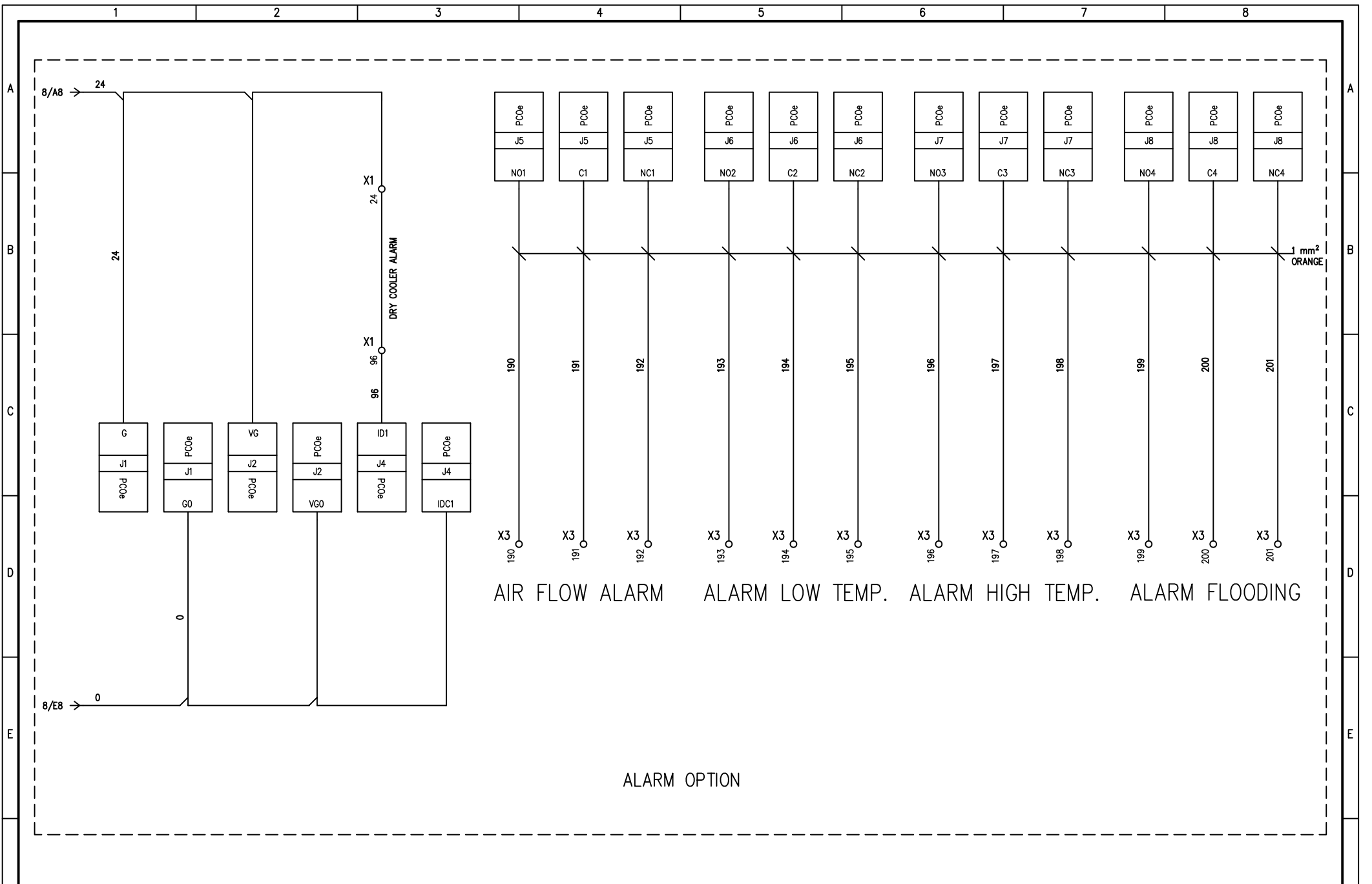

AIR FLOW ALARM

ALARM LOW TEMP.

ALARM HIGH TEMP.

ALARM FLOODING

ALARM OPTION

DATE 03/10/2007

DRAW. N.C.1

CHECK F.F.1

APPR. M.M.



HF620C0719

SHEET 9 OF 21

CONTINUE 10

REV. MODIFICATIONS

DATE

SIGN.

REPLACE

REPLACE

ORIGIN:

1

2

3

4

5

6

7

8

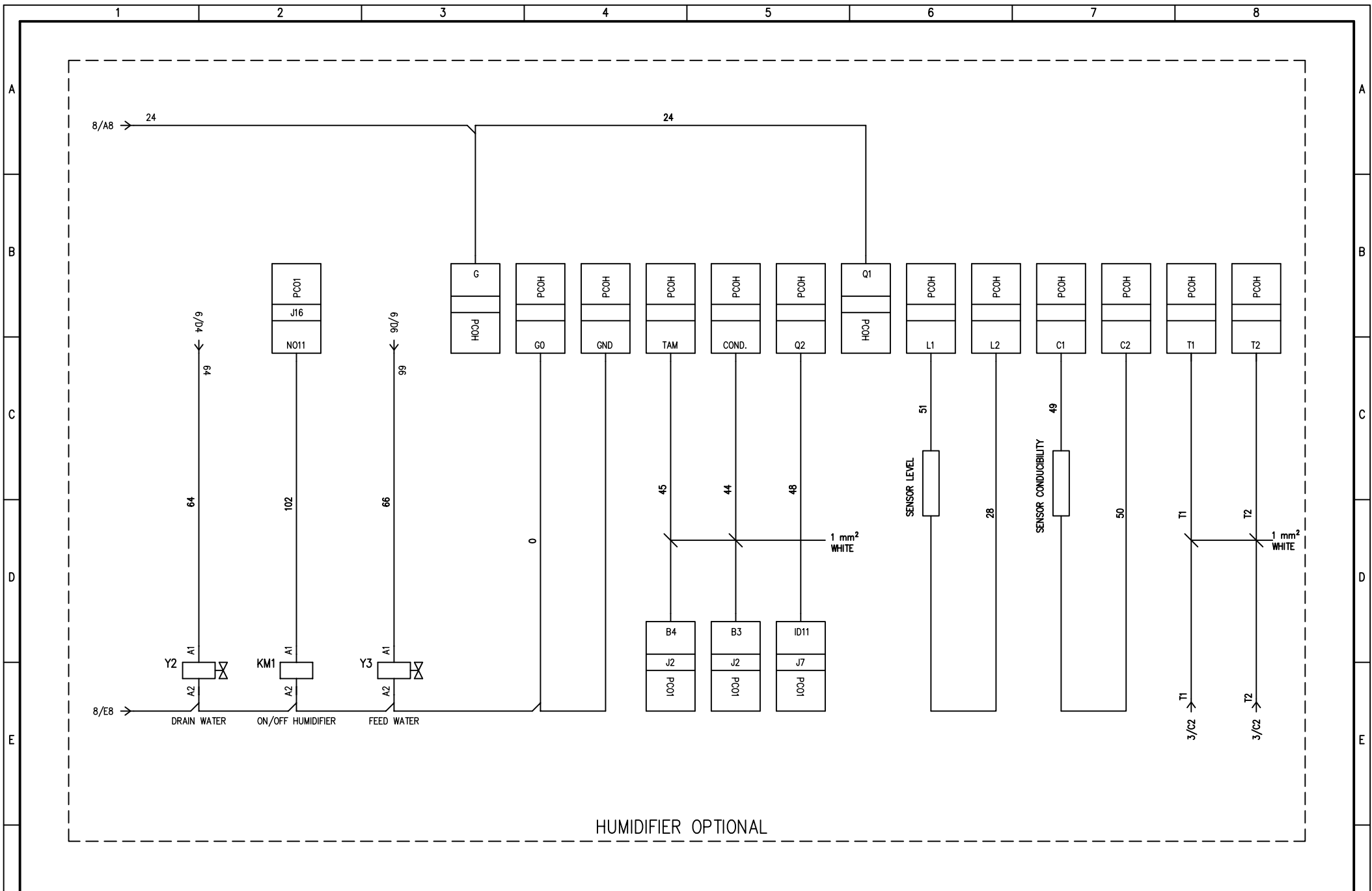

HUMIDIFIER OPTIONAL

				DATE 03/10/2007						
				DRAW. N.C.1						
				CHECK F.F.1						
REV.	MODIFICATIONS	DATE	SIGN.	APPR. M.M.	REPLACE	REPLACE	ORIGIN:	HF620C0719	SHEET 10 OF 21	
1		2		3		4	5	6	7	
									8	
									CONTINUE 11	

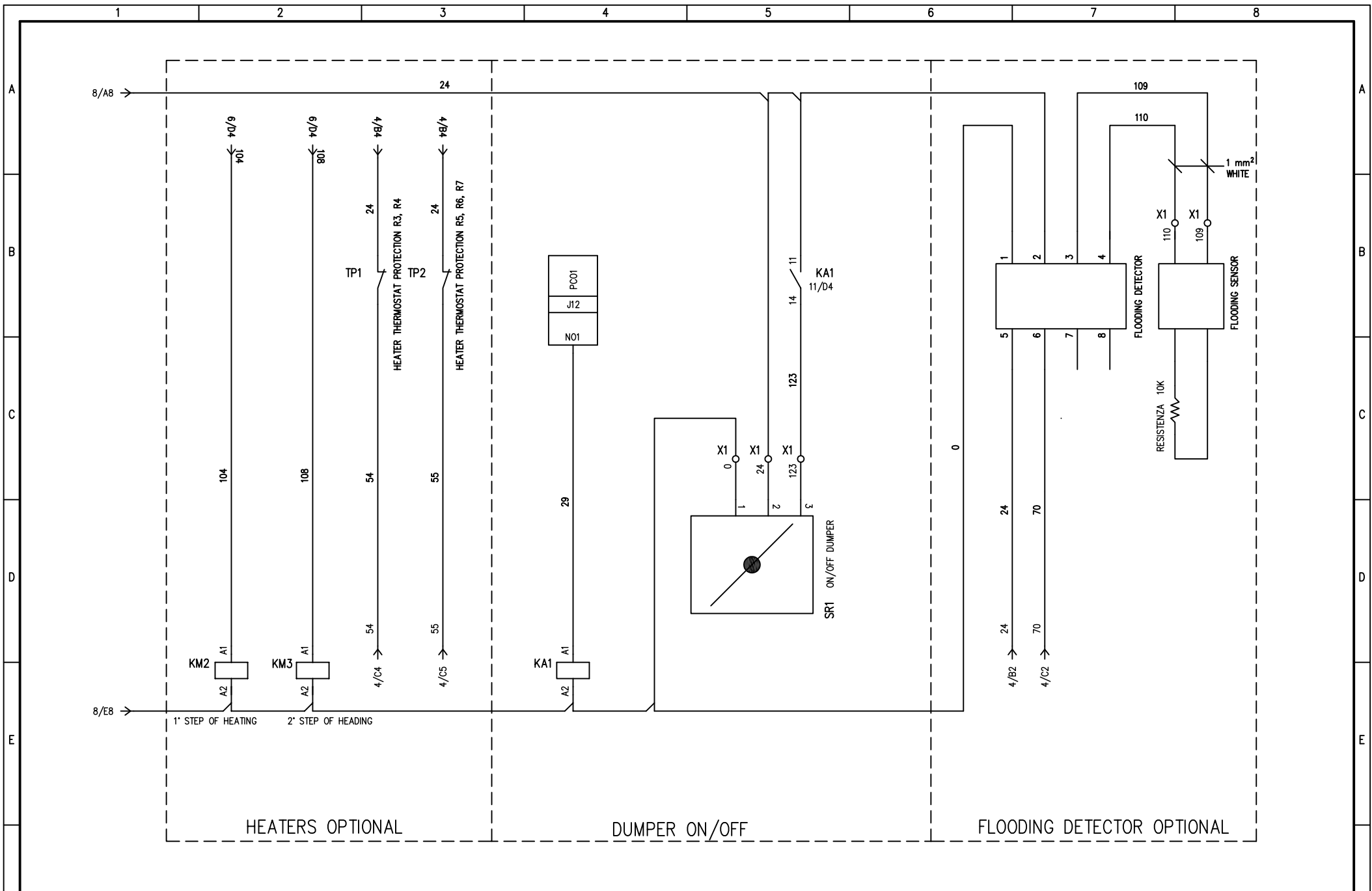

				DATE	03/10/2007										
				DRAW.	N.C.1										
				CHECK	F.F.1										
REV.	MODIFICATIONS	DATE	SIGN.	APPR.	M.M.	REPLACE	REPLACE	ORIGIN:							
1		2		3		4		5							
										LENNOX					
										HF620C0719					
												SHEET 11 OF 21			
												CONTINUE 12			

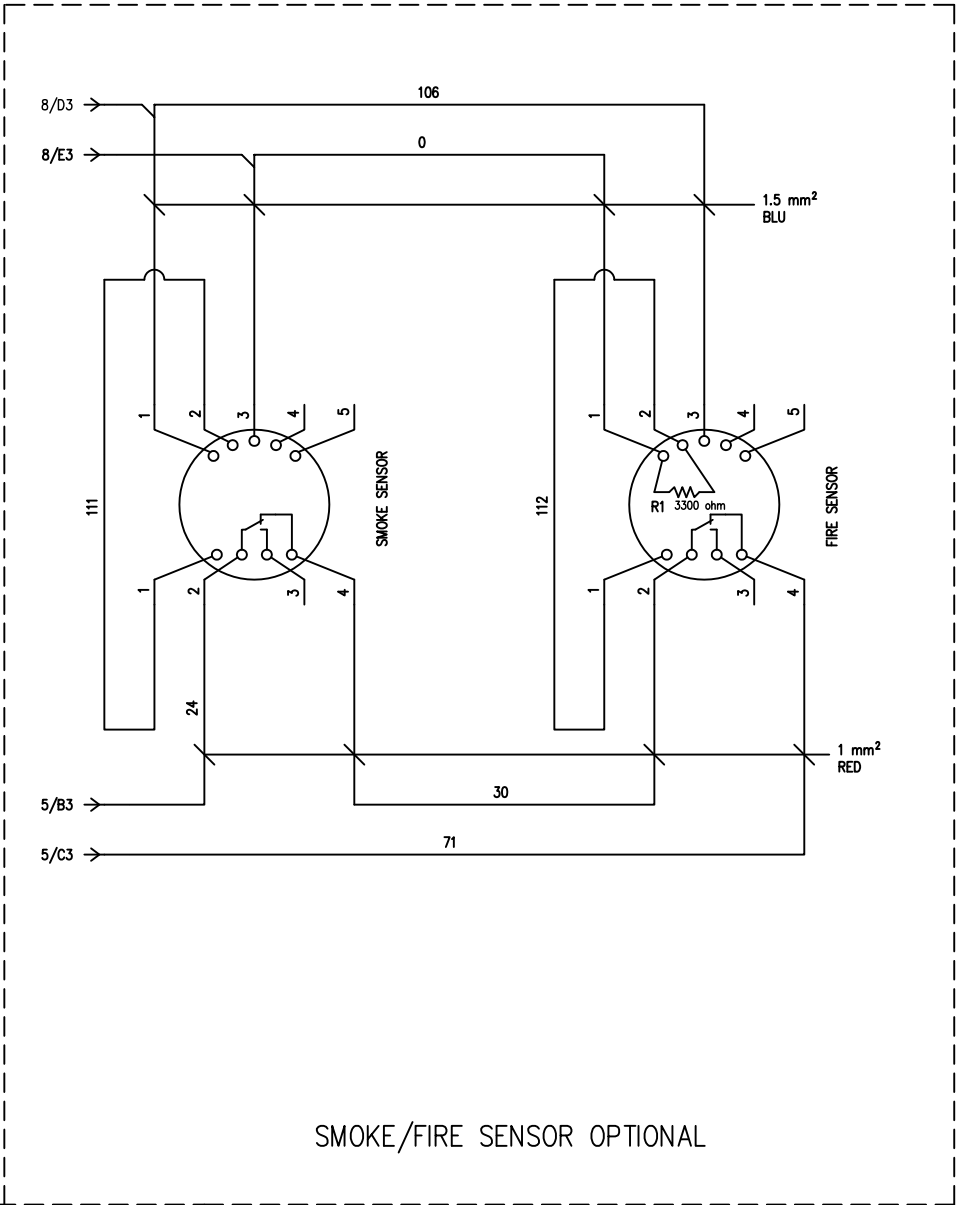
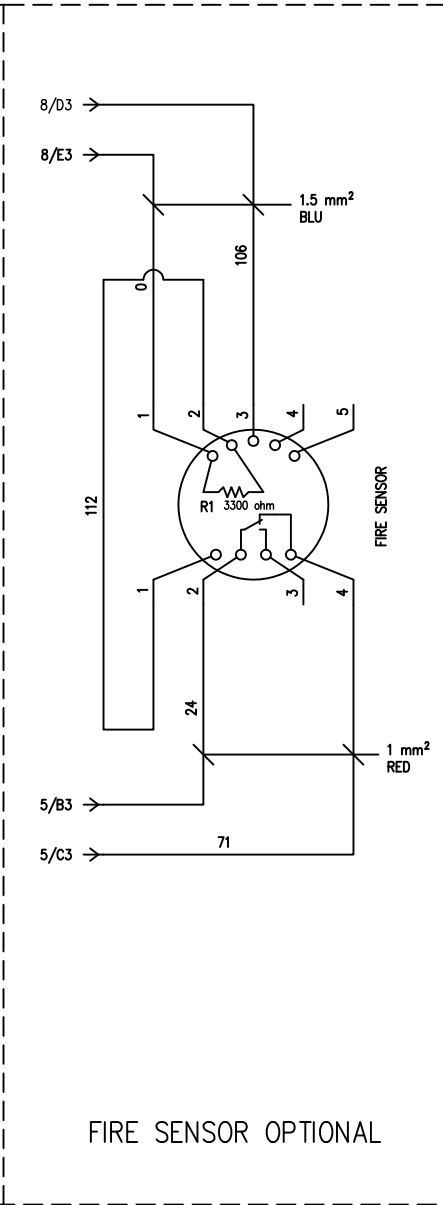
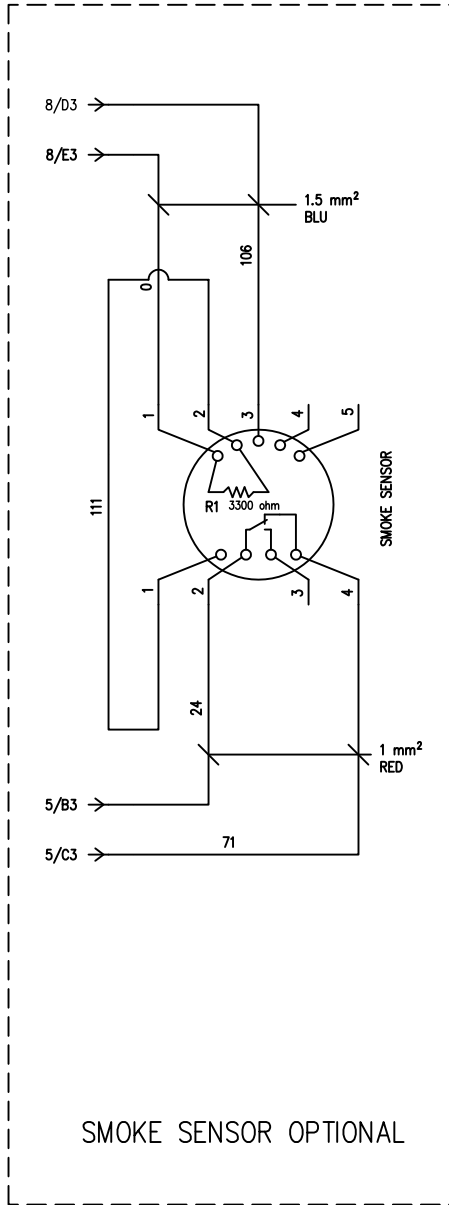

REV.	MODIFICATIONS	DATE	SIGN.	APPR.	M.M.	REPLACE	REPLACE	ORIGIN:

DATE 03/10/2007
 DRAW. N.C.1
 CHECK F.F.1



HF620C0719

SHEET 12 OF 21
 CONTINUE 13

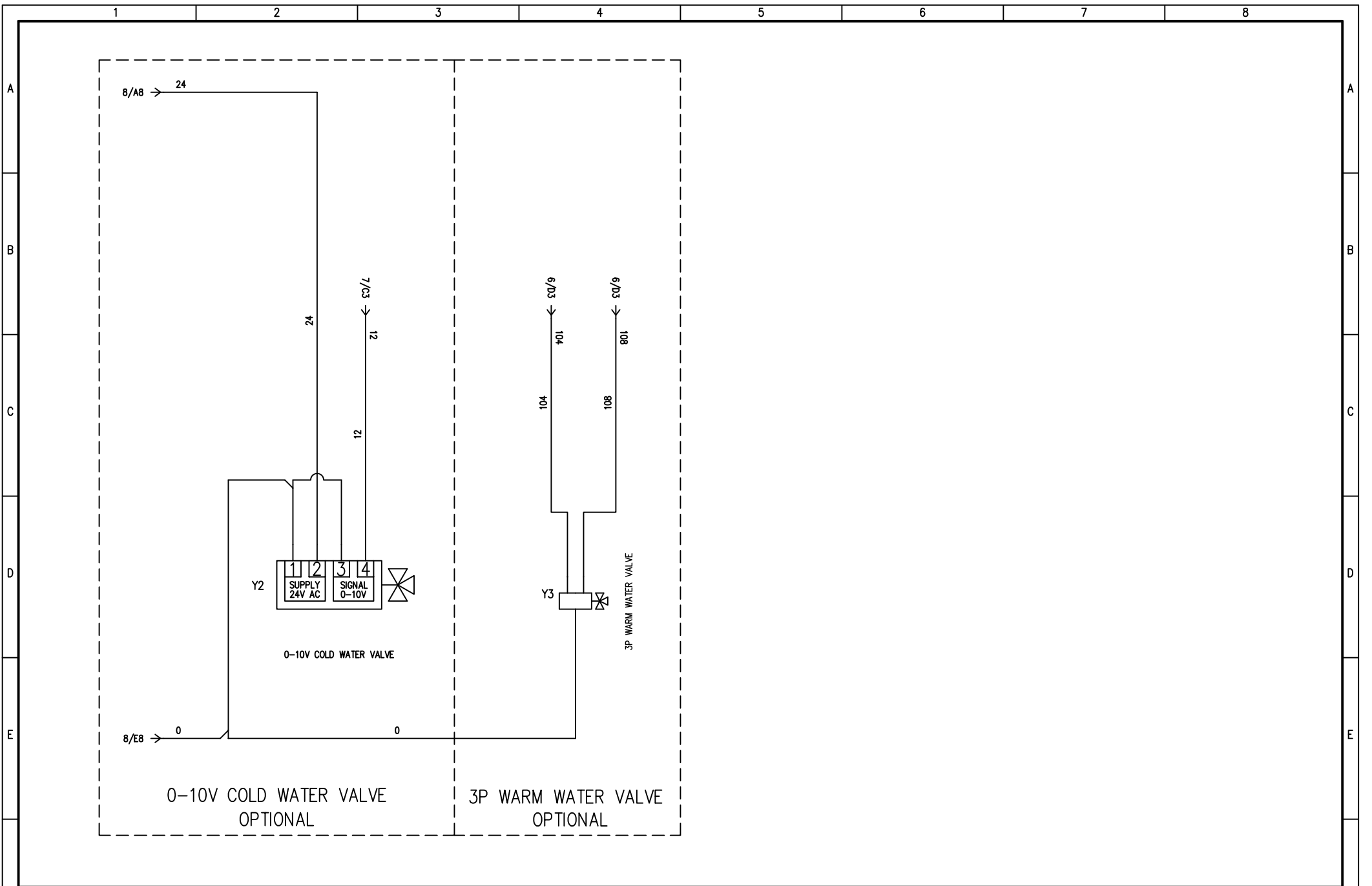

				DATE	03/10/2007								
				DRAW.	N.C.1								
				CHECK	F.F.1								
REV.	MODIFICATIONS	DATE	SIGN.	APPR.	M.M.	REPLACE	REPLACE	ORIGIN:			HF620C0719		SHEET 13 OF 21
1		2		3		4		5	6	7	8	CONTINUE	14



HF620C0719

pLAN CONNECTION

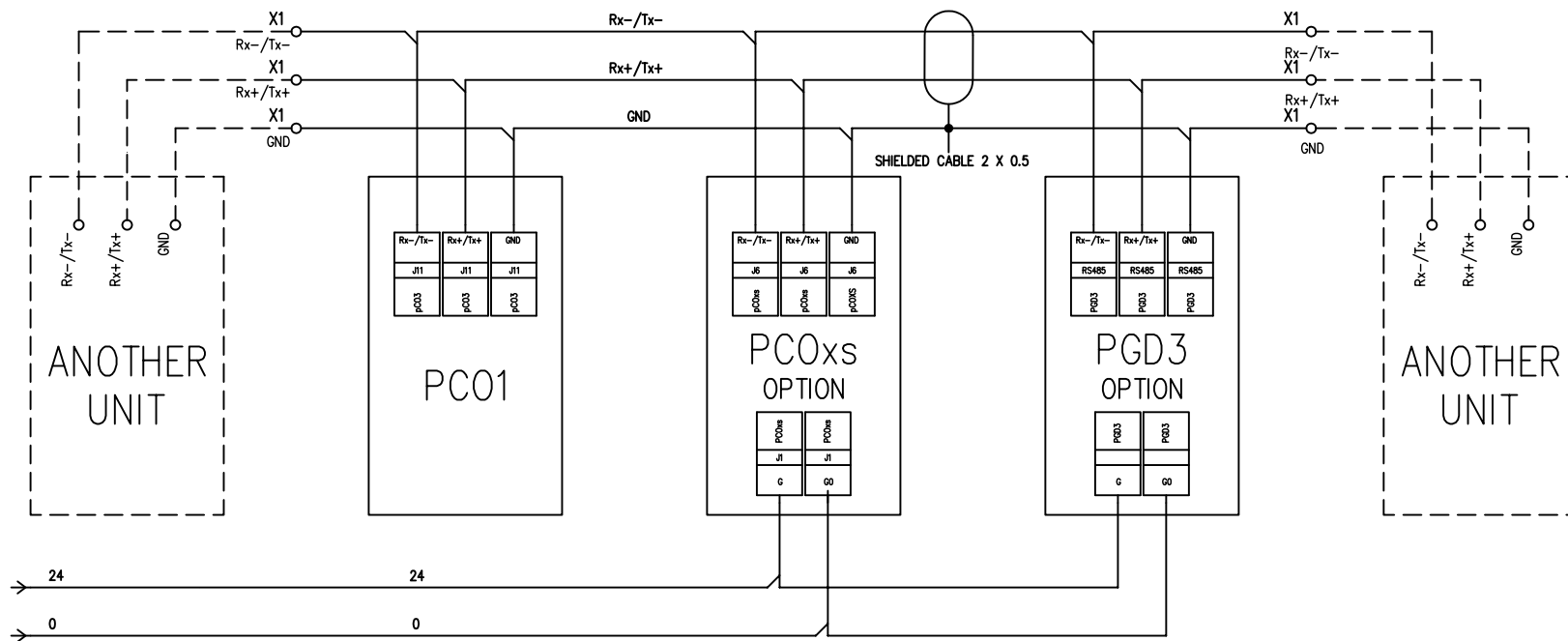

DATE 03/10/2007

DRAW. N.C.1

CHECK F.F.1



HF620C0719

SHEET 14 OF 21

CONTINUE 15

REV. MODIFICATIONS

DATE SIGN.

APPR. M.M.

REPLACE

REPLACE

ORIGIN:

1

2

3

4

5

6

7

8

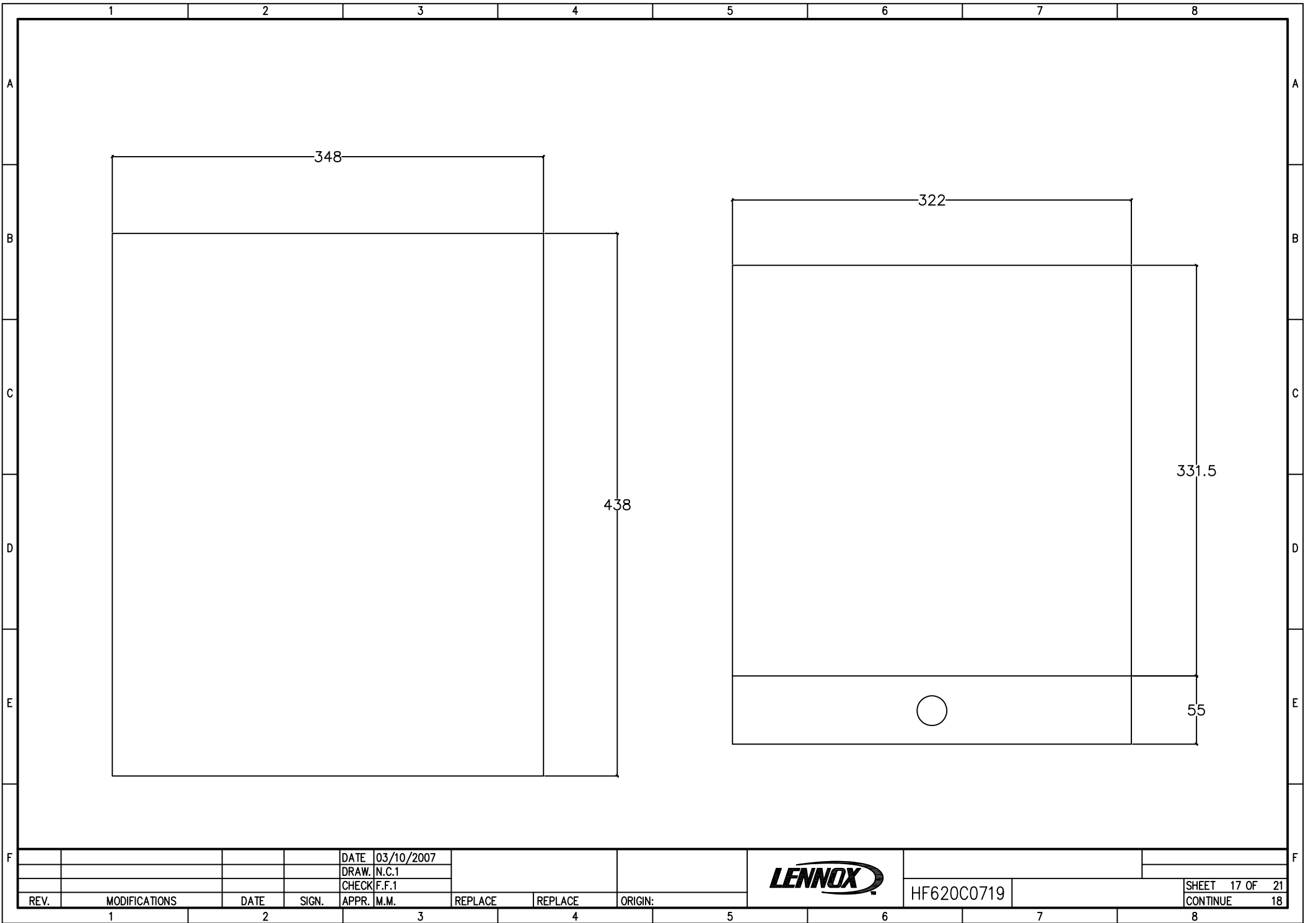

DATE 03/10/2007

DRAW. N.C.1

CHECK F.F.1



HF620C0719

SHEET 17 OF 21

CONTINUE 18

REV.	MODIFICATIONS	DATE	SIGN.	APPR. M.M.	REPLACE	REPLACE	ORIGIN:
------	---------------	------	-------	------------	---------	---------	---------

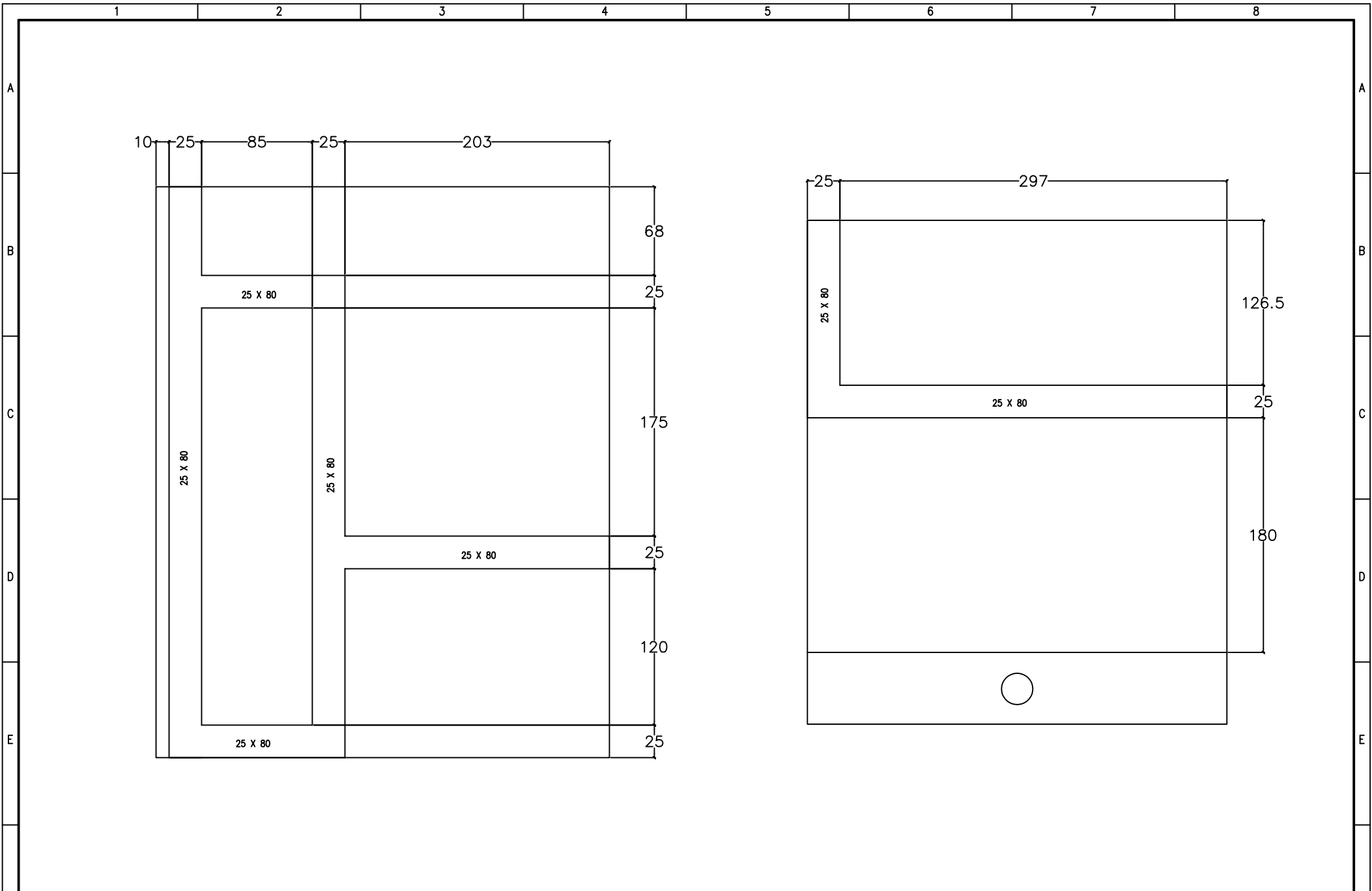

DATE 03/10/2007

DRAW. N.C.1

CHECK F.F.1



HF620C0719

SHEET 18 OF 21

CONTINUE 19

REV.	MODIFICATIONS	DATE	SIGN.	APPR. M.M.	REPLACE	REPLACE	ORIGIN:
1		2		3		4	5

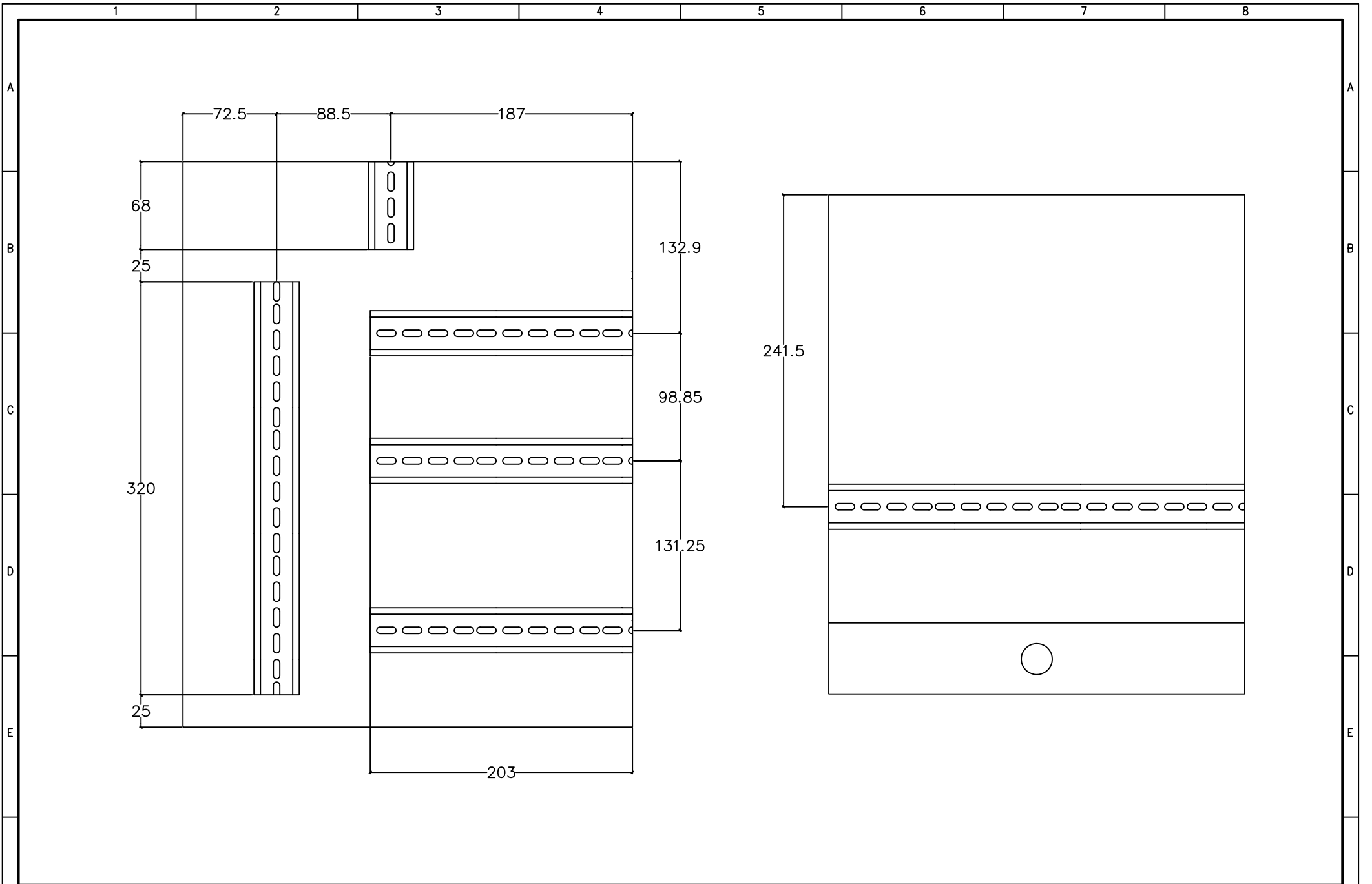

DATE 03/10/2007

DRAW. N.C.1

CHECK F.F.1



HF620C0719

SHEET 19 OF 21

CONTINUE 20

REV.	MODIFICATIONS	DATE	SIGN.	APPR.	M.M.	REPLACE	REPLACE	ORIGIN:
1		2			3		4	5

1

2

3

4

5

6

7

8

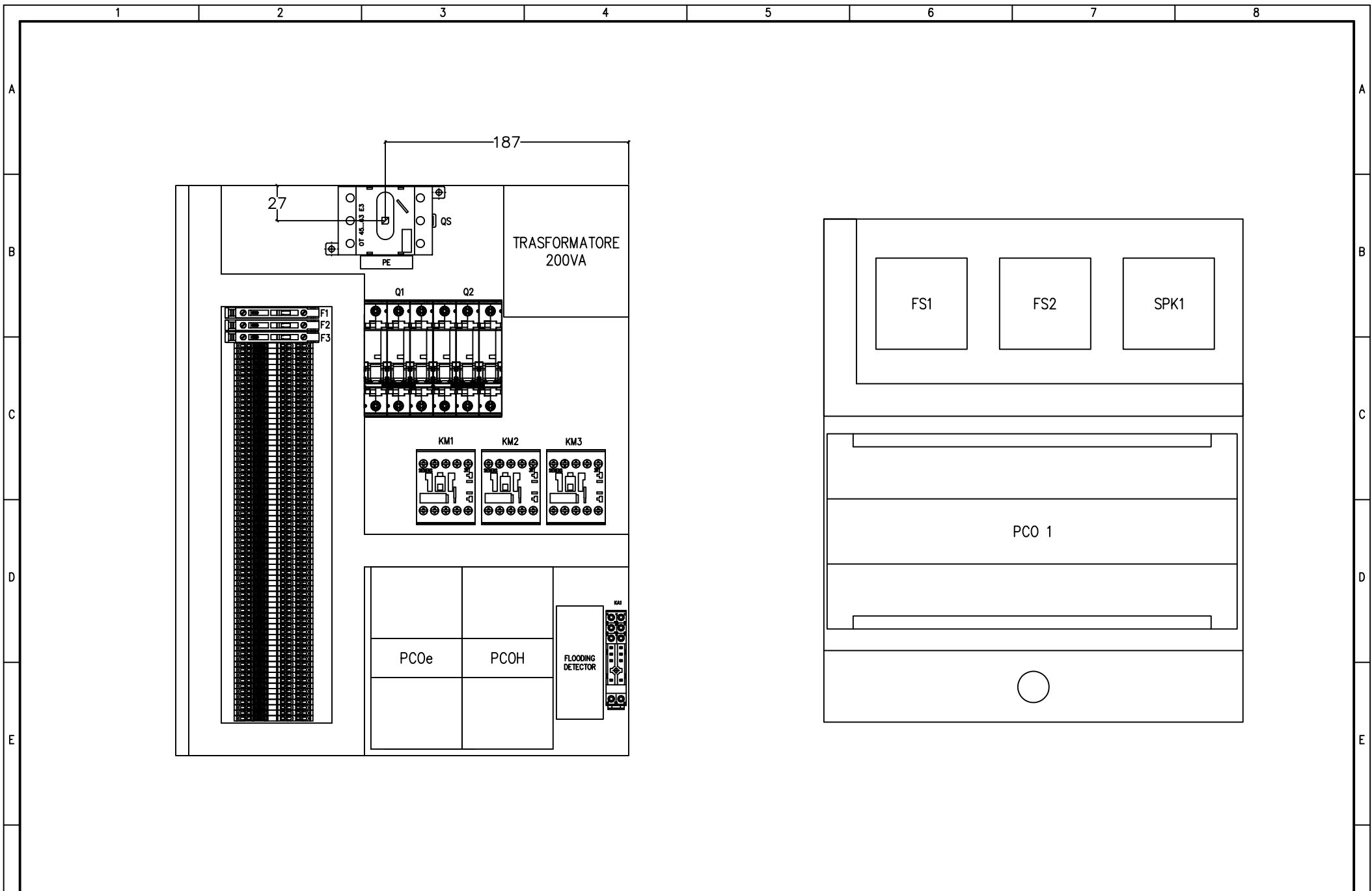

DATE 03/10/2007
 DRAW. N.C.1
 CHECK F.F.1
 APPR. M.M.



HF620C0719

SHEET 20 OF 21
 CONTINUE 21

REV.	MODIFICATIONS	DATE	SIGN.
1		2	

REPLACE	REPLACE	ORIGIN:
3	4	5

1	2		3		4		5		6		7		8																																																									
UBICAZIONE	SIGLA	FUNZIONE	MARCA	CODICE	DESCRIZIONE	QUANTITA'	M.U.	POSIZIONE																																																														
	QS	SEZIONATORE	ABB	OT63E3+OHY3AH1+OXS5X250	SEZIONATORE 3P In= 63A + MANIGLIA + ALBERO	1	PCE																																																															
	Q1	PROTEZIONE VENTILATORI	SIEMENS	5SY6 320-8	INT. AUT. 3P D 20A 6kA	1	PCE																																																															
	Q2	PROTEZIONE UMIDIFICATORE E RESISTENZE	SIEMENS	5SY6 350-7	INT. AUT. 3P C 50A 6kA	1	PCE																																																															
	F1	PROTEZIONE TRASFORMATORE	ITALWEBER	0101001	FUSIBILE IN VETRO 5 X 20 In= 1A	1	PCE																																																															
	F2	PROTEZIONE CIRCUITO DI COMANDO	ITALWEBER	0105008	FUSIBILE IN VETRO 5 X 20 In= 8A	1	PCE																																																															
	F3	PROTEZIONE POMPA SCARICO CONDENZA	ITALWEBER	0101001	FUSIBILE IN VETRO 5 X 20 In= 1A	1	PCE																																																															
	F	MORSETTO PORTA FUSIBILE	PHOENIX	3004100	PER FUSIBILI TIPO G 5 X 20	3	PCE																																																															
	X1, ,X3	MORSETTIERA	PHOENIX	3031128	MORSETTO A MOLLA GRIGIO ST 1,5-TWIN	70	PCE																																																															
	PE	COLLEGAMENTO	PHOENIX	0449014	MORSETTO GIALLO VERDE USLKG35	1	PCE																																																															
	TR	TRSFOMATORE	MARINI	76TM200F	TRASFORMATORE V1=400V / V2=24V S=200VA	1	PCE																																																															
	KM1	ON/OFF UMIDIFICATORE	SIEMENS	3RT1017-1AB01	TELERUTTORE 5,5 KW 3P 400V BOB. 24V AC	1	PCE																																																															
	KM2/KM3	ON/OFF RESISTENZE	SIEMENS	3RT1017-1AB01	TELERUTTORE 5,5 KW 3P 400V BOB. 24V AC	2	PCE																																																															
	KA1	ON/OFF SERRANDA	FINDER	40528024+9505+095.71	RELE' + ZOCCOLO + PONTICELLO DI RITENUTA	1	PCE																																																															
		PIASTRA DI FONDO	HIREF	HF17002693S HF17002663S	PIASTRA DI FONDO	1	PCE																																																															
		VANO Q.E.	HIREF	HF17002662S	VANO Q.E.	1	PCE																																																															
		BARRA DI TERRA			BARRA DI TERRA	1	PCE																																																															
<table border="1"> <tr> <td>DATE</td> <td>03/10/2007</td> <td colspan="2"></td> <td colspan="2"></td> <td colspan="2"></td> <td colspan="2"></td> <td colspan="2"></td> <td colspan="2"></td> </tr> <tr> <td>DRAW.</td> <td>N.C.1</td> <td colspan="2"></td> <td colspan="2"></td> <td colspan="2"></td> <td colspan="2"></td> <td colspan="2"></td> <td colspan="2"></td> </tr> <tr> <td>CHECK</td> <td>F.F.1</td> <td colspan="2"></td> <td colspan="2"></td> <td colspan="2"></td> <td colspan="2"></td> <td colspan="2"></td> <td colspan="2"></td> </tr> <tr> <td>REV.</td> <td>MODIFICATIONS</td> <td>DATE</td> <td>SIGN.</td> <td>APPR.</td> <td>M.M.</td> <td>REPLACE</td> <td>REPLACE</td> <td>ORIGIN:</td> <td colspan="2"></td> <td colspan="2"></td> <td colspan="2"></td> </tr> </table>														DATE	03/10/2007													DRAW.	N.C.1													CHECK	F.F.1													REV.	MODIFICATIONS	DATE	SIGN.	APPR.	M.M.	REPLACE	REPLACE	ORIGIN:						
DATE	03/10/2007																																																																					
DRAW.	N.C.1																																																																					
CHECK	F.F.1																																																																					
REV.	MODIFICATIONS	DATE	SIGN.	APPR.	M.M.	REPLACE	REPLACE	ORIGIN:																																																														
												HF620C0719		SHEET 21 OF 21																																																								
												CONTINUE																																																										