



CARATTERISTICHE ELETTRICHE
ELECTRIC CHARACTERISTIC

SERIES DHCD/UR300...1200-pCO1

Revisione	Foglio	Oggetto	Data	Responsabile
A	1	REVISIONE GENERALE	09/09/2005	POLIDO
B	1	REVISIONE SERRANDA	13/09/2005	
C	1	TOLTO Q1 AGGIUNTO F2	04/05/2006	POLIDO
D	1	colleg. sens fumo	30/03/2007	FF
E	1	REVISIONE GENERALE	16/04/2007	C.N.
F	1	SOSTITUITO Q5	25/06/2007	C.N.
G	1	INSERITA CONNESSIONE PGD3	15/10/2007	C.N.
H	1	AGGIUNTA UNA RESISTENZA	18/03/2008	C.N.
I	1	SOSTITUITO SEZIONATORE	23/03/2008	C.N.
L	1	TOLTO RSF	21/11/2008	C.N.
M	1	SONDE ACQUA IN/OUT	14/01/2009	C.N.

T-REF F					T-REF F+U				
	<i>P totale [kW]</i>	<i>I nominale [A]</i>	<i>I massima [A]</i>	<i>I spunto [A]</i>		<i>P totale [kW]</i>	<i>I nominale [A]</i>	<i>I massima [A]</i>	<i>I spunto [A]</i>
TREF CW 0300	1,482	3,9	3,9	0	TREF CW 0300	7,482	30,0	30,0	0
TREF CW 0400	2,756	7,6	7,6	0	TREF CW 0400	8,756	33,7	33,7	0
TREF CW 0500	2,816	7,6	7,6	0	TREF CW 0500	8,816	33,7	33,7	0
TREF CW 0650	2,942	7,7	7,7	0	TREF CW 0650	8,942	33,8	33,8	0
TREF CW 0900	4,323	11,6	11,6	0	TREF CW 0900	10,323	37,6	37,6	0
TREF CW 1000	4,476	11,6	11,6	0	TREF CW 1000	10,476	37,7	37,7	0
TREF CW 1200	4,476	11,6	11,6	0	TREF CW 1200	10,476	37,7	37,7	0

T-REF F+C					T-REF F+C+U				
	<i>P totale [kW]</i>	<i>I nominale [A]</i>	<i>I massima [A]</i>	<i>I spunto [A]</i>		<i>P totale [kW]</i>	<i>I nominale [A]</i>	<i>I massima [A]</i>	<i>I spunto [A]</i>
TREF CW 0300	7,882	31,7	31,7	0	TREF CW 0300	13,882	57,8	57,8	0
TREF CW 0400	9,156	35,4	35,4	0	TREF CW 0400	15,156	61,5	61,5	0
TREF CW 0500	9,216	35,5	35,5	0	TREF CW 0500	15,216	61,5	61,5	0
TREF CW 0650	12,542	49,4	49,4	0	TREF CW 0650	18,542	75,5	75,5	0
TREF CW 0900	13,923	53,3	53,3	0	TREF CW 0900	19,923	79,4	79,4	0
TREF CW 1000	14,076	53,4	53,4	0	TREF CW 1000	20,076	79,5	79,5	0
TREF CW 1200	14,076	53,4	53,4	0	TREF CW 1200	20,076	79,5	79,5	0

VERS.

"F"= SOLO FREDDO-ONLY COOLING
 "F+C"= FREDDO/CALDO-ONLY COOLING/HEATING
 "F+U"= FREDDO/UMIDITA'-COOLING/HUMIDITY
 "F+C+U"= FREDDO/CALDO/UMIDITA'- COOLING/HEATING/HUMIDITY

DATE	14/07/2005							
DRAW.	P.M.							
CHECK	P.M.							
REV.	MODIFICATIONS	DATE	SIGN.	APPR.	M.M.	REPLACE	REPLACE	ORIGIN:



HF620C0302

SHEET 1 OF 20
CONTINUE 2

SIGN.	Descriptions	Note	
KM3	CONTATTATORE UMIDIFICATORE HUMIDIFIER CONT. CONT. HUMIDIFICATEUR BEFEUCHTER VERSORGUNG CONT. HUMIDIFICADOR		
KM4	CONTATTATORE MOTOVENTILATORE FAN MOTOR CONTACTOR CONTACTEUR VENTILATEUR VENTILATOR SCHUETZ CONTACTOR DEL MOTOVENTILADOR		
TR	TRASFORMATORE TRANSFORMER TRANSFORMATEUR TRANSFORMATOR TRANSFORMADOR		
QS	INTERRUTTORE GENERALE MAIN SWITCH INTERRUPTEUR GENERAL HAUPTSCHALTER INTERRUPTOR GENERAL		
M1 M2 M3	MOTOVENTILATORE EVAPORANTE EVAP. FAN MOTOR MOTEUR VENTILATEUR DE EVAP. EVAP.-LUEFTER MOTOVENTILADOR EVAPORADORA		
CN1 CN2	COND. DI RIFASAMENTO POWER FACT. CORRECTION COND. CORRECT. COS. PHI KOND. KORR. COS. PHI COND. DE COMP. DE FASES		
SM	TEMPERATURA ARIA IN MANDATA DISCHARGE AIR TEMPERATURE SONDE DE TEMPERATURE ZULUFTTEMPERATUR TEMP. DE LA DESCARGA DE AIRE		
SE	TEMPERATURA ARIA ESTERNA OUTDOOR AIR SENSOR SONDE D'AIR EXTERNE AUSSENLUFTUEHLER SONDA DE AIRE EXTERNA		
R1 R2	RISCALDAMENTO ELETTRICO EL. HEATERS CHAUFFAGE ELECTRIQUE ELETR. HAIZUNG RESISTENCIAS ELETRICAS		

SIGN.	Descriptions	Note	
RSF	RELE' SEQUENZA FASE PHASE SEQUENCE CONTROL RELAY RELAIS DE CONTROLE DE PHASE D'ETAGE STEUERRELAIS FUER PHASENFOLGE RELE' CONTROL SECCUENCIA FASES		
SR1	SERRANDA DAMPER REGISTRE MOTORISIESTE COMPUERTA		
FS1	PRESSOSTATO FLUSSO ARIA AIR FLOW PRESSURE SWITCH PRESSOST. D'ENCRASSEMENT DE FILTRE DRUCKSCHALTER NIEDERDRUCK PRESOSTATO DE BAJA		
TP1 TP2	TERMOSTATO SICUREZZA RISCALDAMENTO HEATING SAFETY THERMOSTAT THERMOSTAT DE SECURITE' CHAUFFAGE THERMOSTATE ELEKTROHEIZUNG TERMOSTATO DE SEGURIDAD DE LAS RESISTENCIAS		
P1	PRESIONE CONDENSAZIONE CONDENSING PRESSION SENSOR SONDE DU PRESSION DE CONDENSATION KONDENSATIONSDRUCK-FUEHLER SONDA PRESION CONDENSACION		
SA	TEMPERATURA AMBIENTE INTERNO SHELTER INTERNAL AIR TEMPERATURE SENSOR SONDE TEMPERATURE D'AIR EINTERIOR AUSSENER LUFTTEMP.-FILTER SONDA DE TEMPERATURA DE LA DESCARGA DE AIRE		
BP1 BP2	PRESSOSTATO DI BASSA LOW PRESSURE P-STAT PRESSOSTAT BASSE PRESSION DRUCKSCHALTER NIEDERDRUCK PRESOSTATO DE BAJA		
FS2	PRESSOSTATO FILTRI SPORCHI CLOGGED FILTER PRESSURE SWITCH PRESSOSTAT D'ENCRASSEMENT DE FILTRE DRUCKSCHALTER. FILTERVERSCHMUTZUNG PRESOSTATO FILTROS SUCIOS		
Y4	CARICO ACQUA UMID. HUMIDIFIER FEED VALVE ELECTROVANNE D'ALIM. DE HUMID. BEFEUCHTER VERSORGUNG VALVULA ALIM. HUMIDIF.		

SIGN.	Descriptions	Note	
Q1	INTERR. RSF SWITCH RSF INTERR. RSF AUTOMATISCHER RSF INTERR. RSF		
SU	SONDA UMIDITA' HUMIDITY PROBE HYGRUMETRIE FUEHLER LUFTFEUCHTIGKEITSMESSUNG SONDE DE HUMEDAD		
Q4	INTERR. UMIDIFICATORE SWITCH HUMIDIFIER INTERR. HUMIDIFIC. AUTOMATISCHER BEFEUCHTER INTERR. HUMIDIF.		
Q5	INTERR. VENTILATORI SWITCH FANS INTERR. VENT. AUTOMATISCHER VENT. INTERR. VENT.		
Q6	INTERR. RISCALDAMENTO ELETTRICO SWITCH E. HEATERS INTERR. CHAUFFAGE ELET. AUTOMATISCHER ELETR.HAIZUNG INTERR. RES.		
Q7	INTERR. AUSILIARI SWITCH AUX INTERR. AUS. AUTOMATISCHER AUX INTERR. AUS.		
FS3	PRESSOSTATO FLUSSO ACQUA		
TP3 TP4 TP5	TERMICHE VENTILATORI TERMAL PROTECTIONS FANS TERMICHE VENTILATORI TERMICHE VENTILATORI TERMICHE VENTILATORI		
Y5	SCARICO ACQUA UMID. HUMIDIFIER DRAIN VALVE ELECTR. DE DRAINAGE DE HUMID. BEFEUCHTER ENTFUEHLUNG VALVULA DESAGUE HUMID.		

DATE	14/07/2005							
DRAW.	P.M.							
CHECK	P.M.							
REV.	MODIFICATIONS	DATE	SIGN.	APPR.	M.M.	REPLACE	REPLACE	ORIGIN:



HF620C0302

SHEET 2 OF 20
CONTINUE 3

LIMITE DI FORNITURA
 LIMIT OF EQUIPMENT
 LIMITE D'EQUIPEMENT
 LIEFERUNGRENZE
 LIMITE DE SUMINISTRO

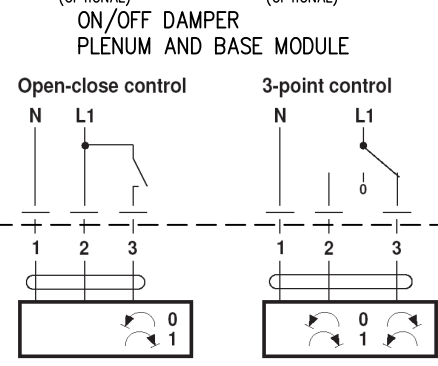
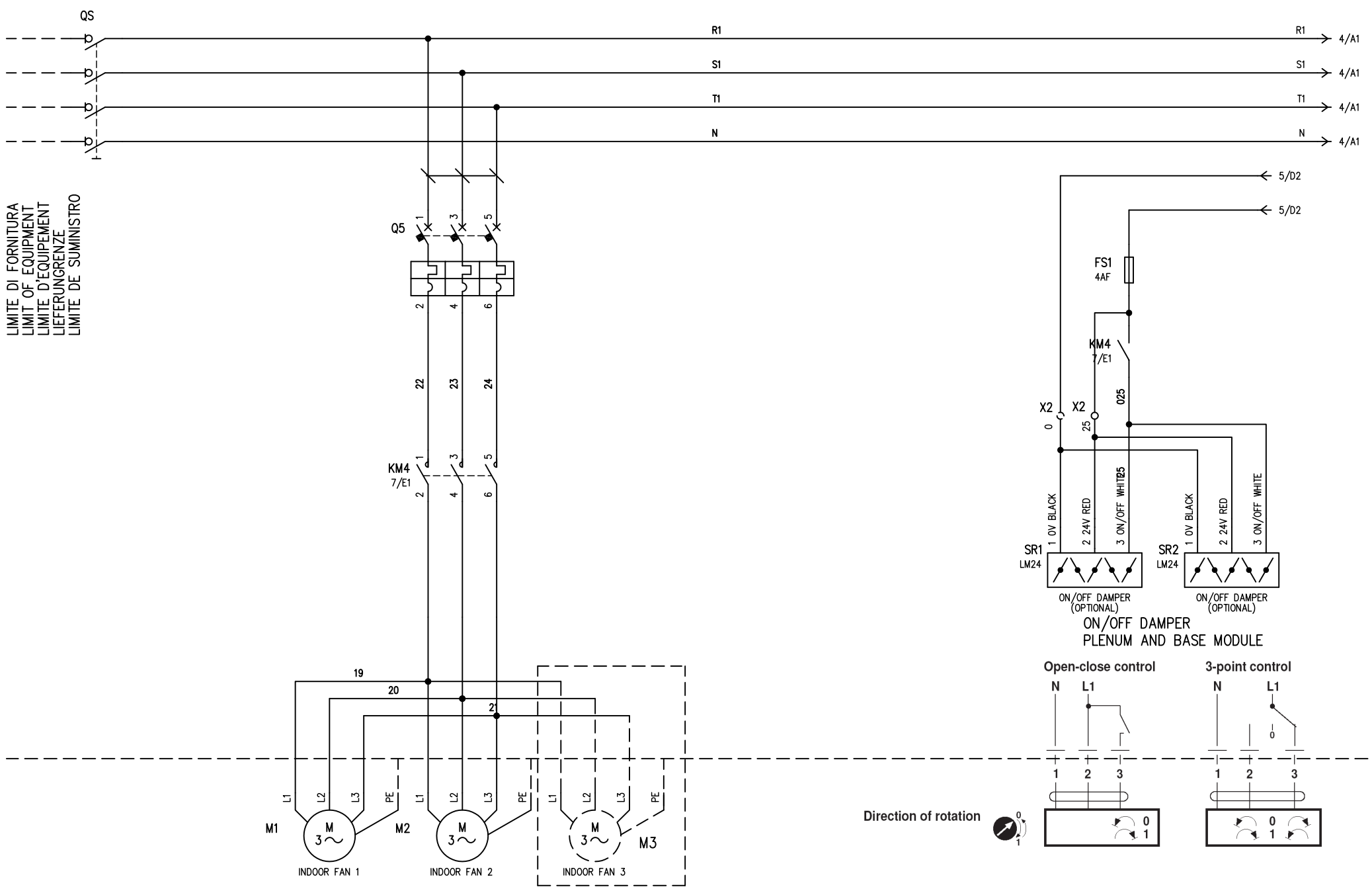

REV.	MODIFICATIONS	DATE	SIGN.	APPR.	M.M.	REPLACE	REPLACE	ORIGIN:



DATE 14/07/2005

DRAW. P.M.

CHECK P.M.

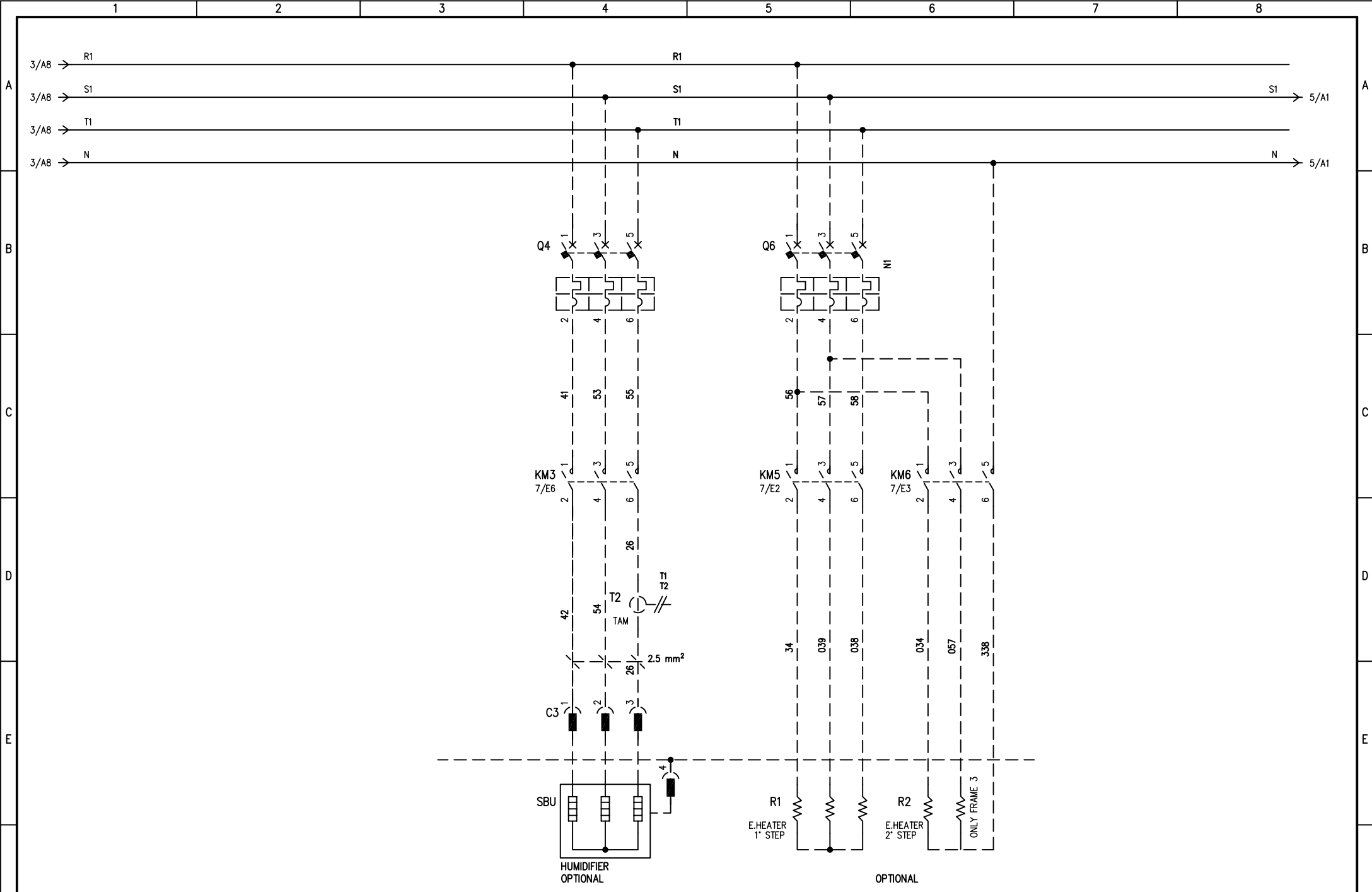

				DATE	14/07/2005								
				DRAW.	P.M.								
				CHECK	P.M.								
REV.	MODIFICATIONS	DATE	SIGN.	APPR.	M.M.	REPLACE	REPLACE	ORIGIN:			HF620C0302		SHEET 4 OF 20
1		2		3		4		5	6	7	8	CONTINUE	5



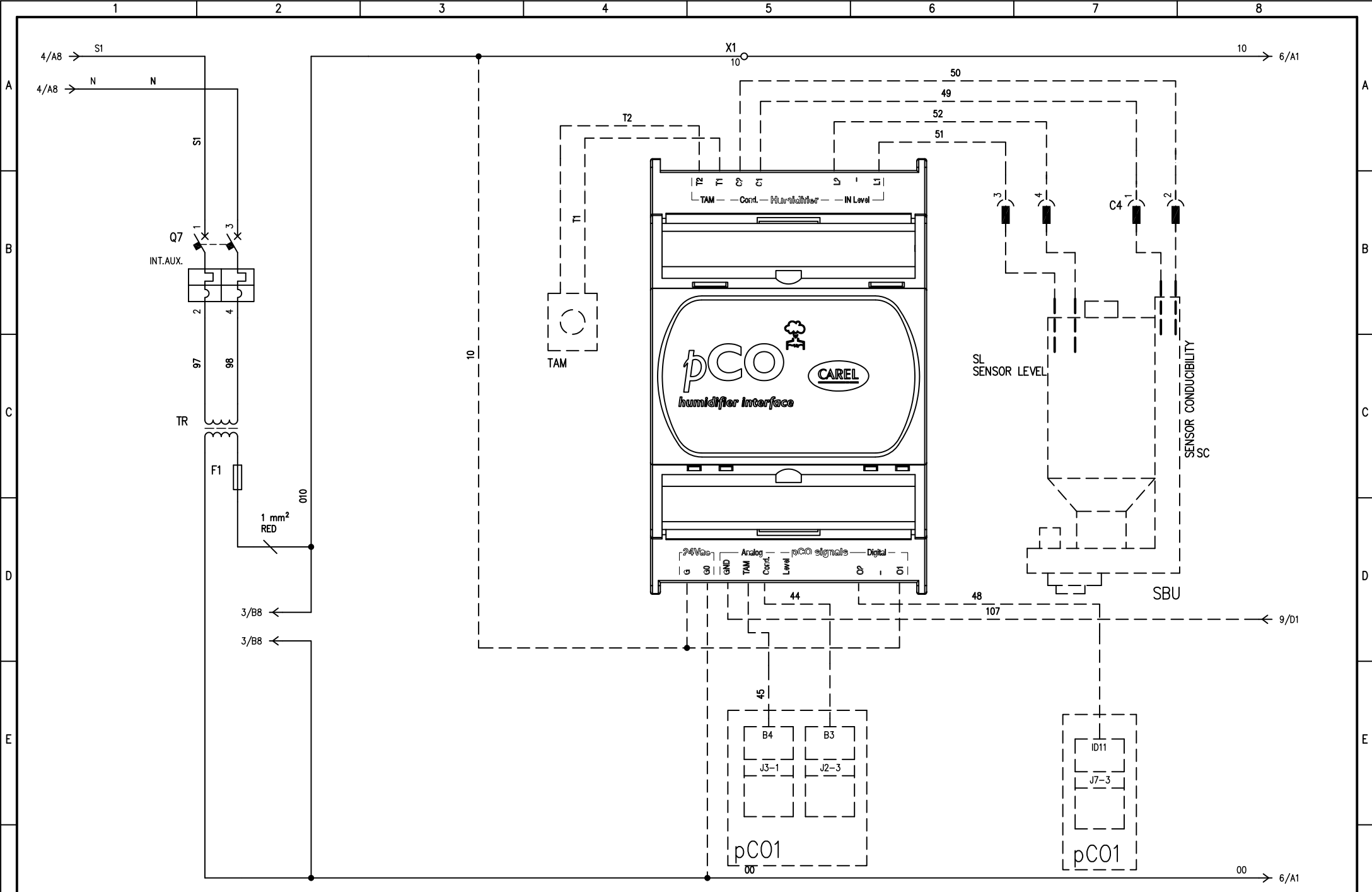

REV.	MODIFICATIONS	DATE	SIGN.	APPR.	M.M.	REPLACE	REPLACE	ORIGIN:

DATE 14/07/2005
 DRAW. P.M.
 CHECK P.M.



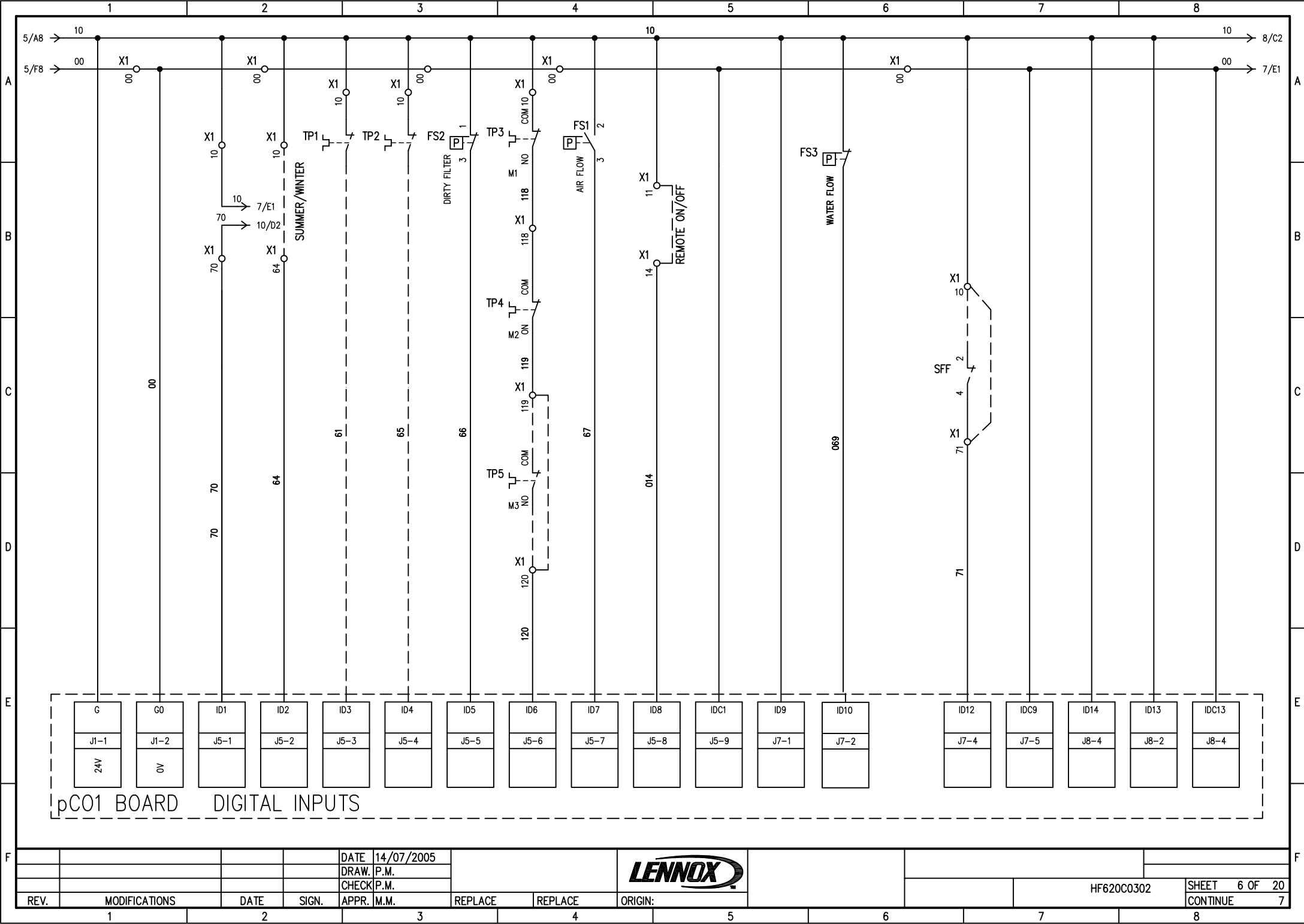

pC01 BOARD DIGITAL INPUTS

DATE 14/07/2005
 DRAW. P.M.
 CHECK P.M.



REV.	MODIFICATIONS	DATE	SIGN.	APPR.	M.M.	REPLACE	REPLACE	ORIGIN:
1		2						

pCO1 DIGITAL OUTPUTS

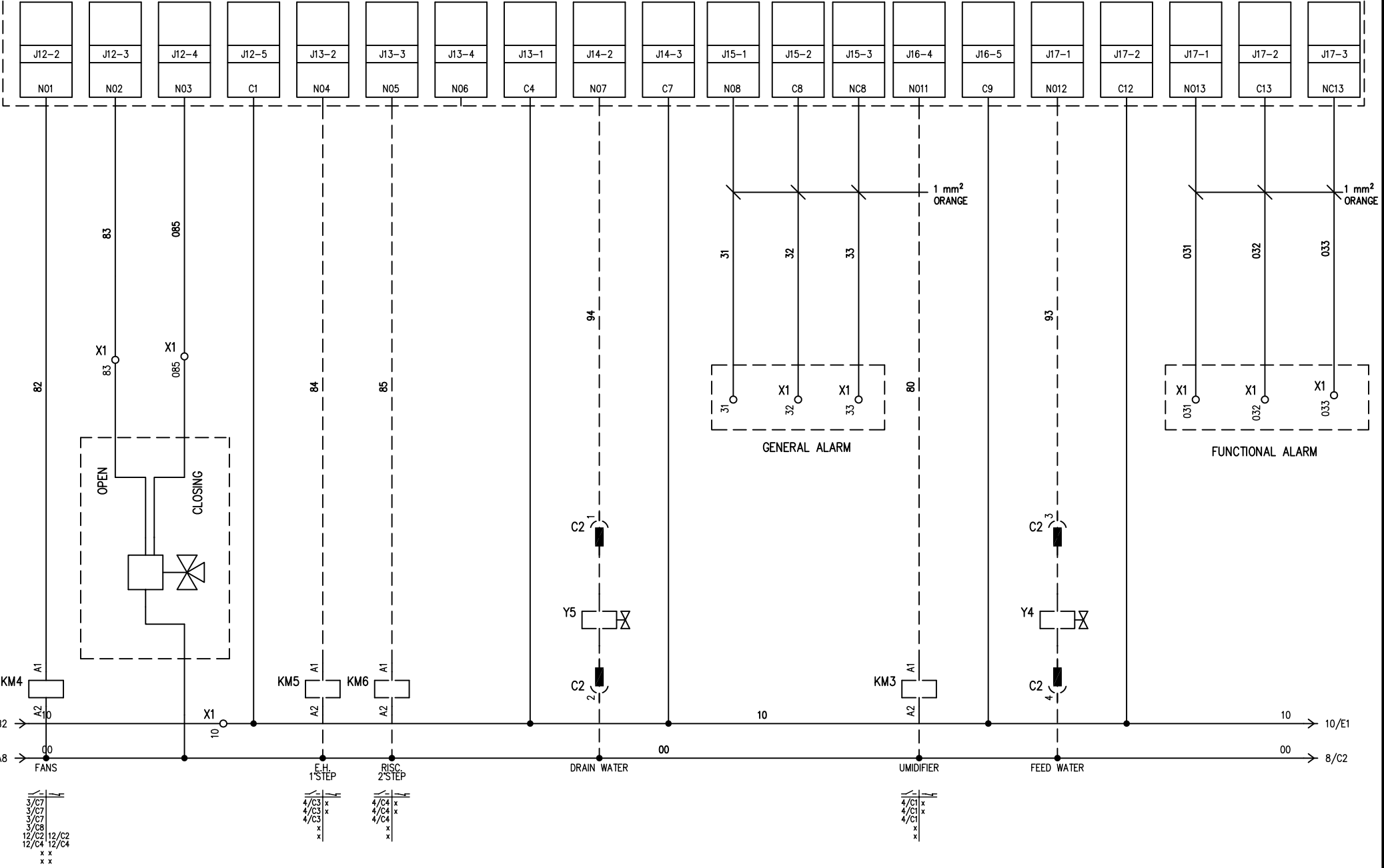

DATE 14/07/2005		DRAW. P.M.		CHECK P.M.				HF620C0302		SHEET 7 OF 20		
APPR. I.M.M.		REPLACE		REPLACE				ORIGIN:		CONTINUE		8
REV.	MODIFICATIONS	DATE	SIGN.	APPR.	I.M.M.	REPLACE	REPLACE	ORIGIN:				

CONTROLLO VENTILATORI
 FANS MOTOR CONTROL
 CONTROL VENTILATEUR

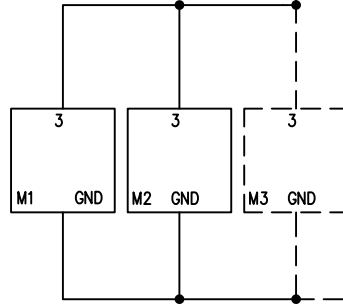
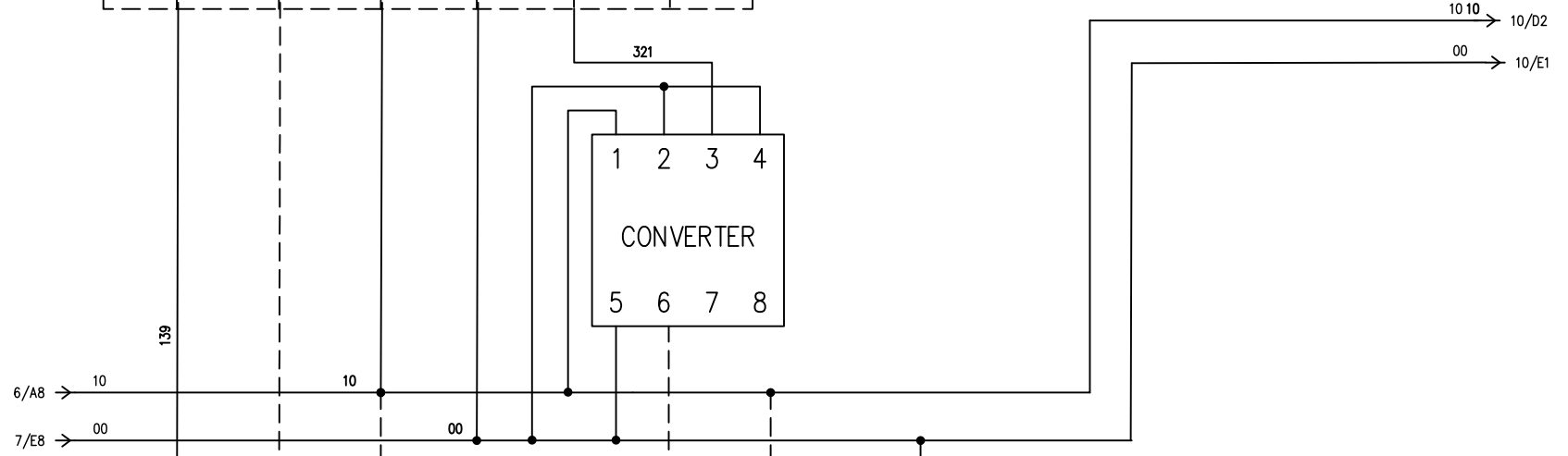
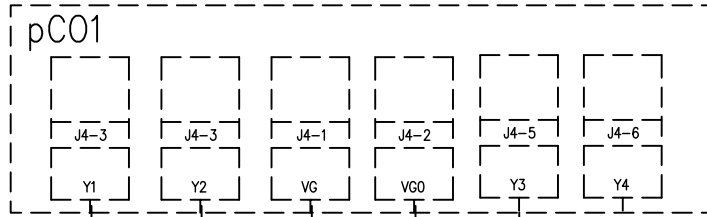

EC FANS 0-10V SIGNAL

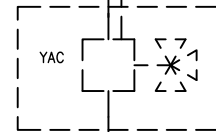

VALVOLA ACQUA FREDDA (OPZ.)
 COLD WATER VALVE (OPT.)
 VANNE DE REGUL. EAU CHAUDE (OPT.)
 WEGEWARMWASSERVENTIL (ZUB.)
 VALVILA AGUA FRIA (OPC.)

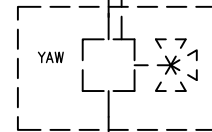

VALVOLA ACQUA CALDA (OPZ.)
 HOT WATER VALVE (OPT.)
 VANNE DE REGUL. EAU CHAUDE (OPT.)
 WEGEWARMWASSERVENTIL (ZUB.)
 VALVILA AGUA CALIENTE (OPC.)

DATE 14/07/2005		DRAW. P.M.		CHECK P.M.				HF620C0302		SHEET 8 OF 20	
REV.	MODIFICATIONS	DATE	SIGN.	APPR. M.M.	REPLACE			REPLACE	ORIGIN:	CONTINUE	

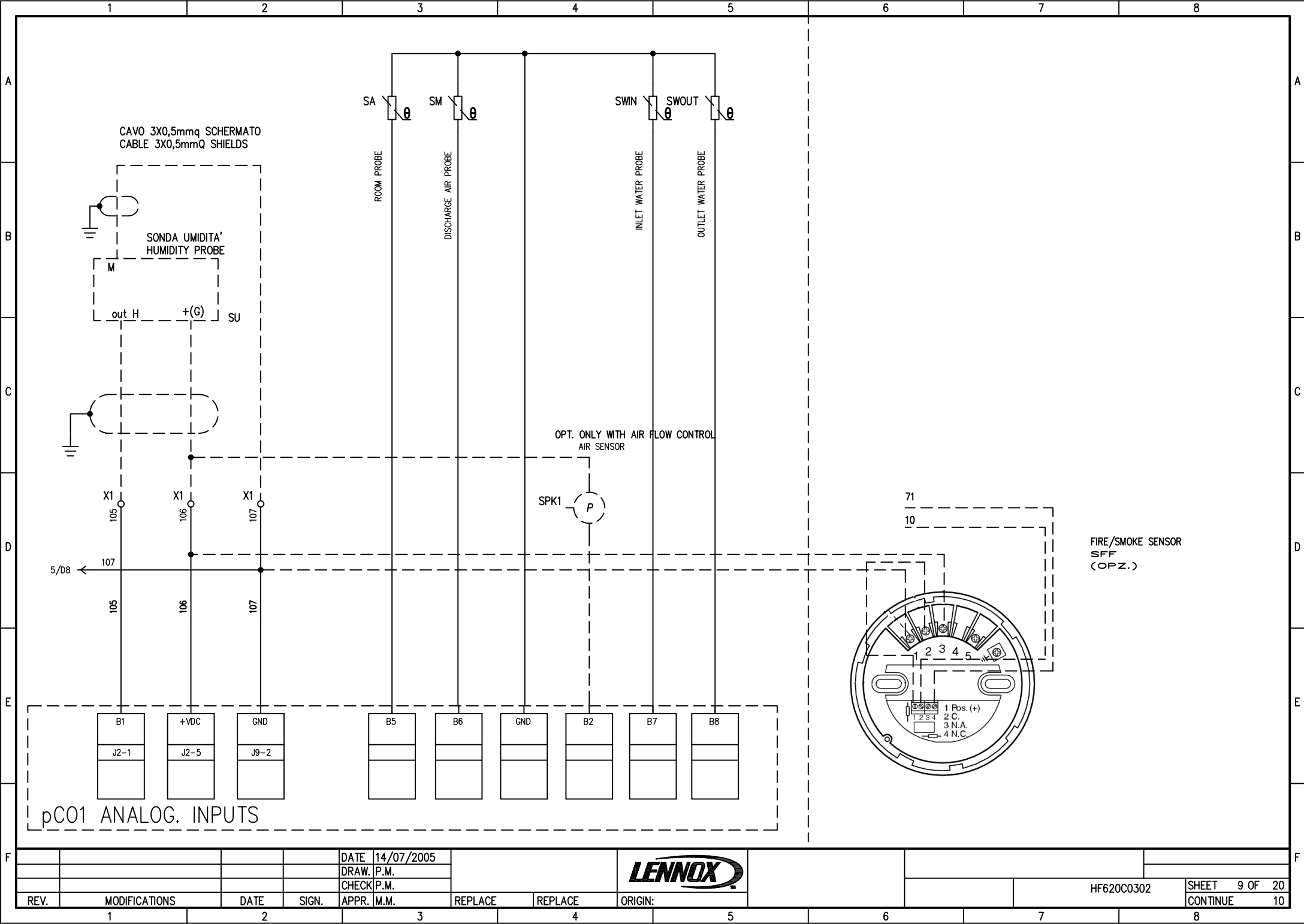

CAVO 3X0,5mmq SCHERMATO
CABLE 3X0,5mmQ SHIELDS

SONDA UMIDITA'
HUMIDITY PROBE

ROOM PROBE

DISCHARGE AIR PROBE

INLET WATER PROBE

OUTLET WATER PROBE

OPT. ONLY WITH AIR FLOW CONTROL
AIR SENSOR

SPK1

FIRE/SMOKE SENSOR
SFF
(OPZ.)

pCO1 ANALOG. INPUTS

DATE 14/07/2005
DRAW. P.M.
CHECK P.M.



HF620C0302

SHEET 9 OF 20
CONTINUE 10

REV.	MODIFICATIONS	DATE	SIGN.	APPR.	M.M.	REPLACE	REPLACE	ORIGIN:
1		2						

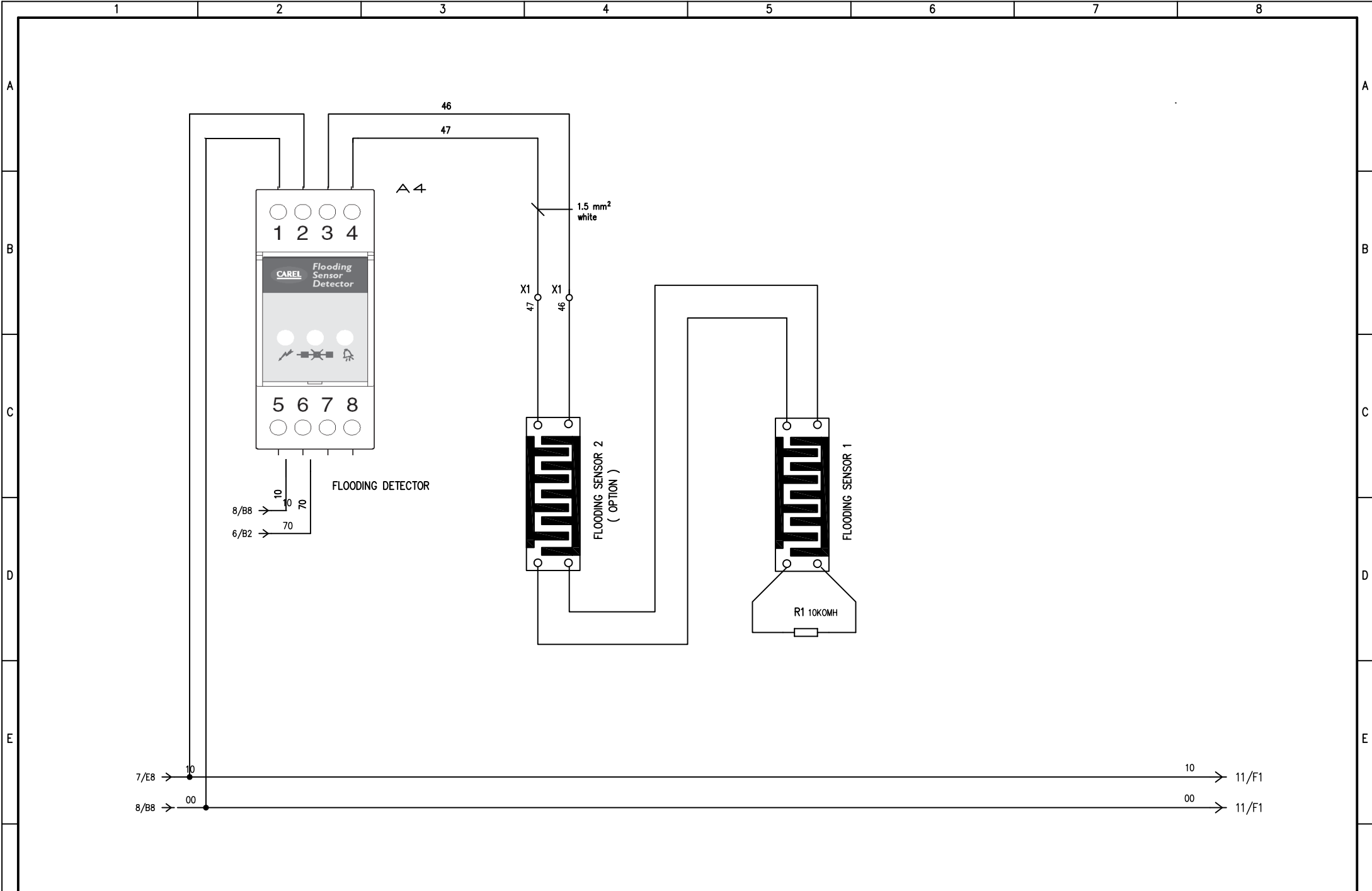

				DATE	14/07/2005								
				DRAW.	P.M.								
				CHECK	P.M.								
REV.	MODIFICATIONS	DATE	SIGN.	APPR.	M.M.	REPLACE	REPLACE	ORIGIN:				HF620C0302	SHEET 10 OF 20
1		2		3		4		5	6	7	8		CONTINUE 11



pCOE BOARD

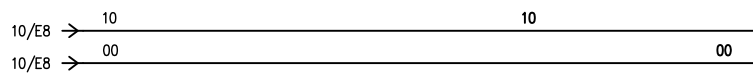
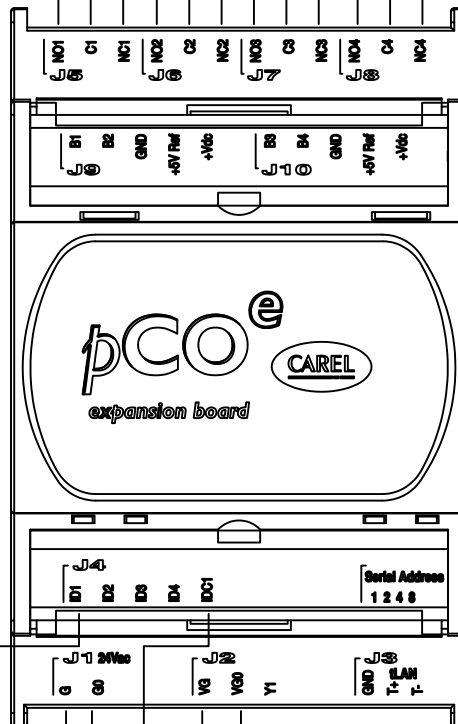
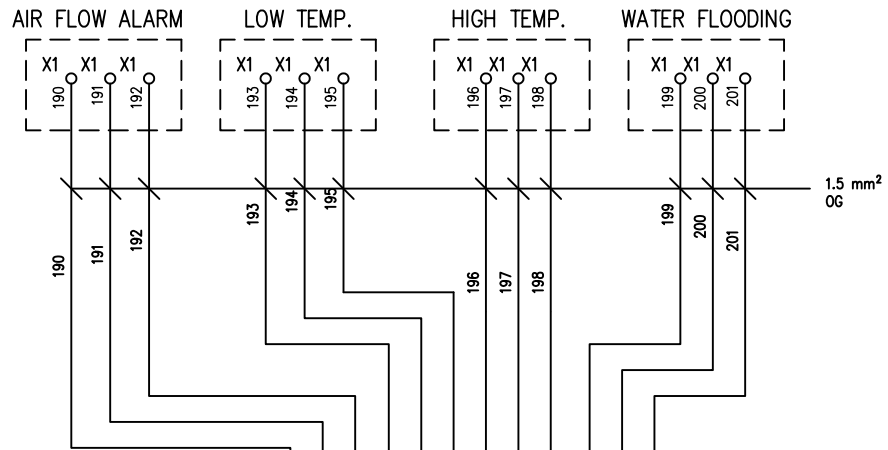

				DATE	14/07/2005								
				DRAW.	P.M.								
				CHECK	P.M.								
REV.	MODIFICATIONS	DATE	SIGN.	APPR.	M.M.	REPLACE	REPLACE	ORIGIN:			HF620C0302		SHEET 11 OF 20
1		2		3		4		5	6	7	8	CONTINUE	12



CONTATTI PULITI SEGNALAZIONE REMOTA
 REMOTE SIGNAL CLEAN CONTACTS
 CONTACTS PROPRES SIGNALISATIONS A DISTANCE
 FREIE KONTAKTE FUER BETRIEBSMELDUNGEN
 CONT. LIMPIOS CON SENGNALIZACIONES REMOTAS

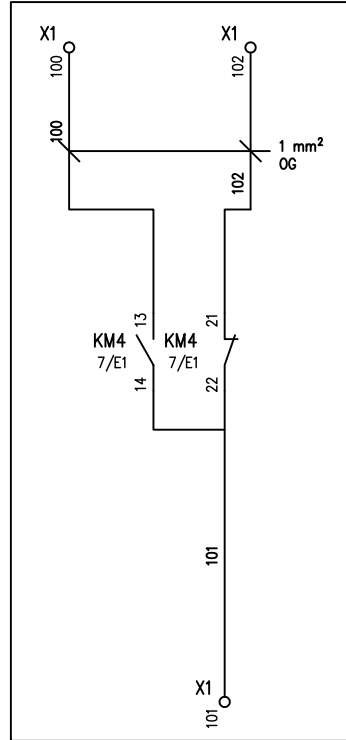

EXT. DAMPER ON/OFF
 FAN ON/OFF SIGNAL

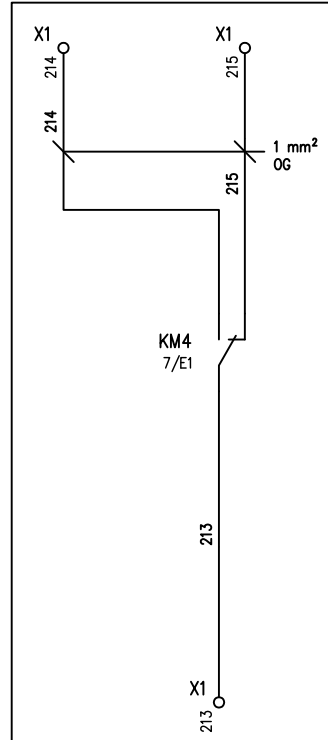

ON/OFF UNIT STATUS

POMPA SCARICO CONDENZA
 CONDENSATE DRAIN PUMP
 POMPE A EAU CONDENSEUY
 KONDENSATWASS PUMPE
 BOMBA DESEQUE CONDEN.

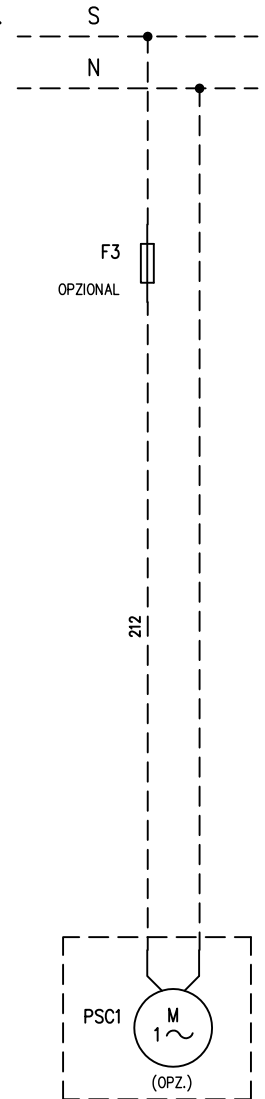

DATE	14/07/2005				
DRAW.	P.M.				
CHECK	P.M.				
REV.	MODIFICATIONS	DATE	SIGN.	APPR.	M.M.



HF620C0302

SHEET 12 OF 20
 CONTINUE 13

LAN CONNECTIONS

SHIELD

MAX 8 UNITS

USARE LA CALZA PER LA CONNESSIONE DEL GND
USE THE SHIELDS FOR GND CONNECTIONS

USARE LA CALZA PER LA CONNESSIONE DEL GND
USE THE SHIELDS FOR GND CONNECTIONS

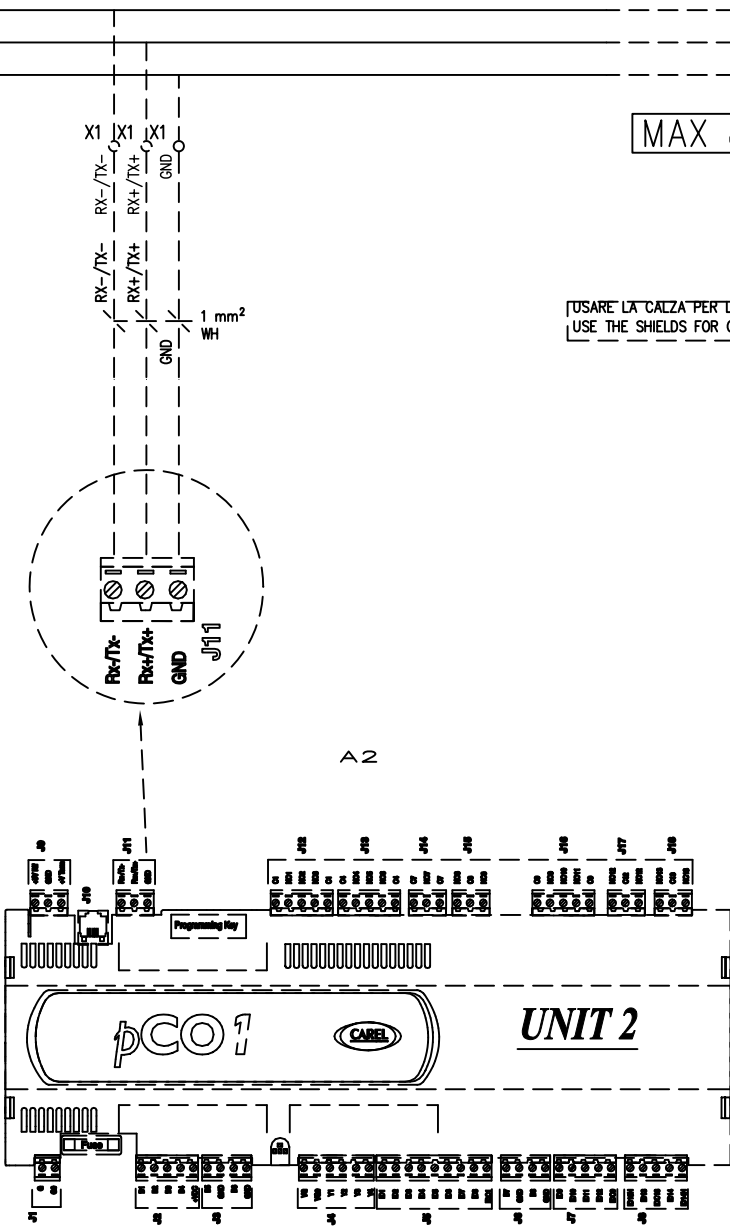
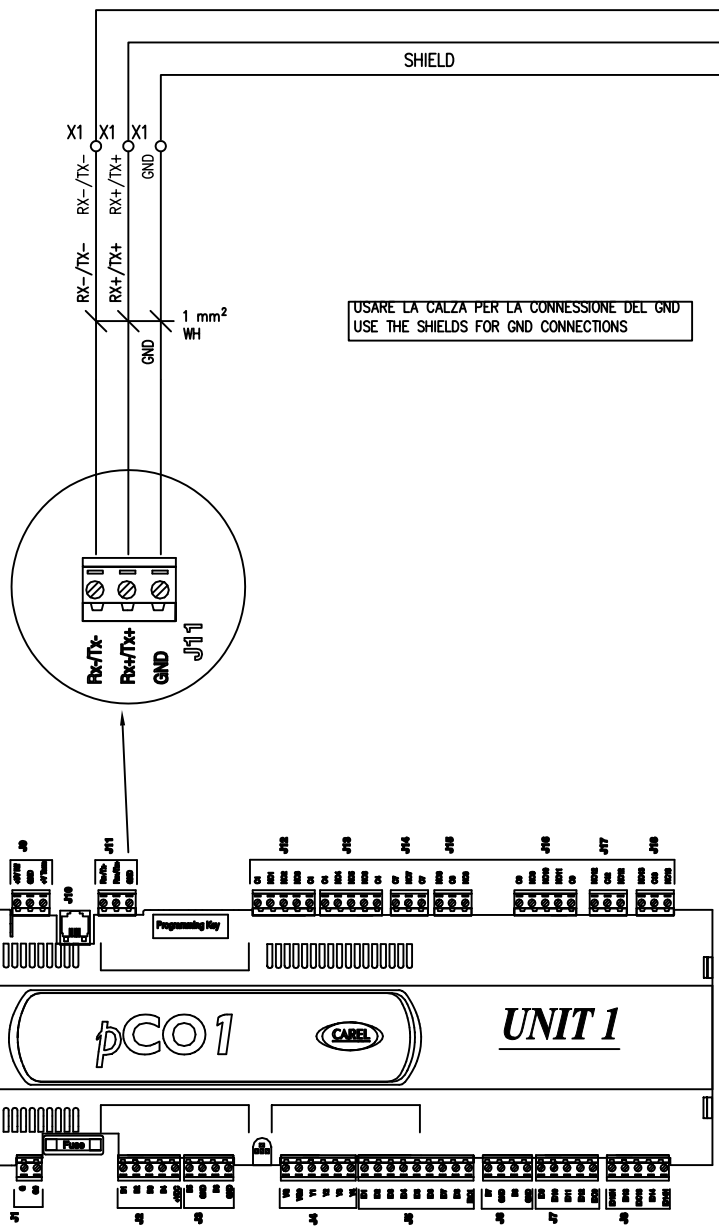

REV.	MODIFICATIONS	DATE	SIGN.	APPR.	M.M.	REPLACE	REPLACE	ORIGIN:	LENNOX		HF620C0302	SHEET 13 OF 20
1		2		3		4		5	6	7	8	CONTINUE 14

ELECTRICAL CONNECTION OF THE GRAPHICAL DISPLAY (pGD3)

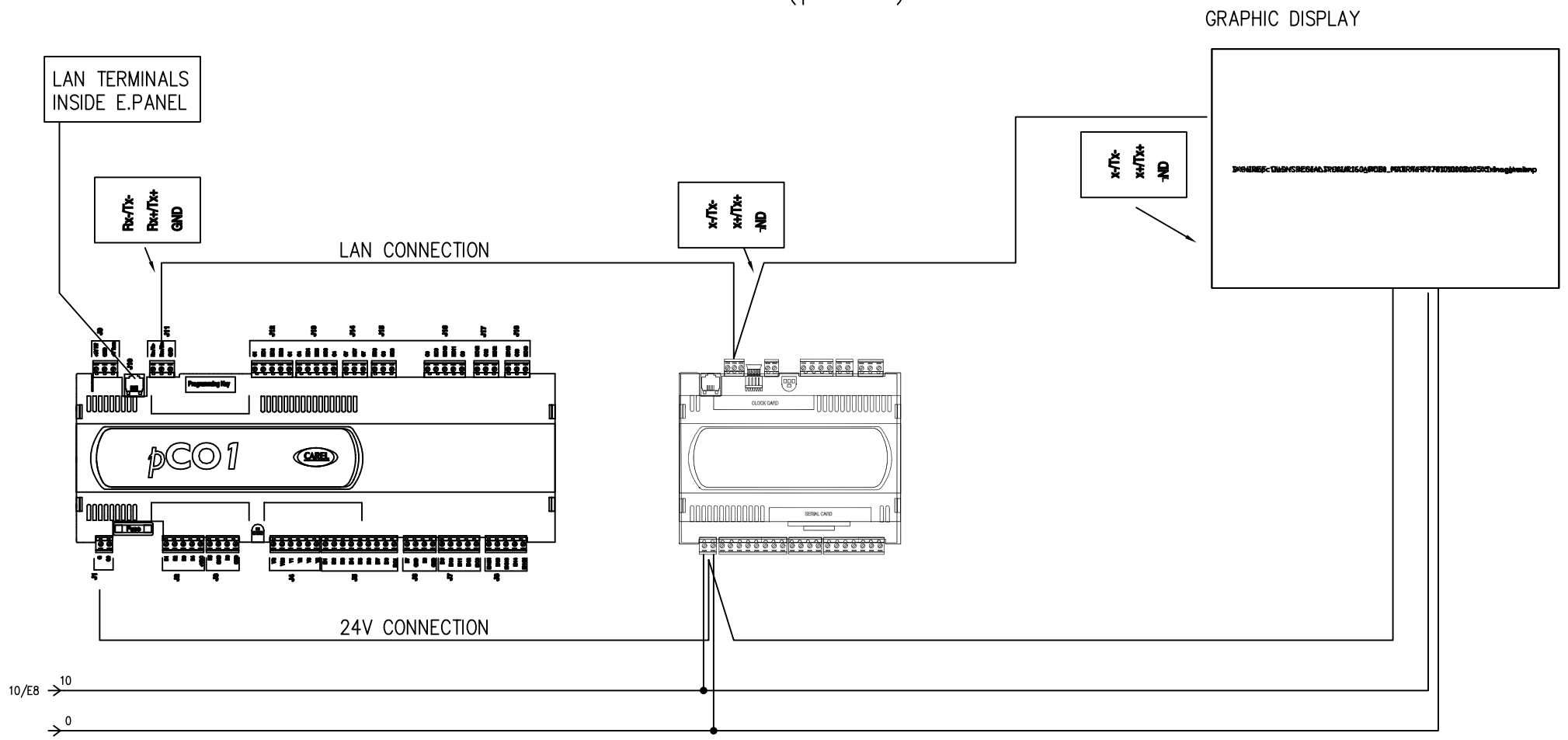

				DATE 14/07/2005				
				DRAW. P.M.				
				CHECK P.M.				
REV.	MODIFICATIONS	DATE	SIGN.	APPR. M.M.	REPLACE	REPLACE	ORIGIN:	HF620C0302
1		2		3				SHEET 14 OF 20 CONTINUE 15

MORSETTIERA
 TERMINAL STRIP
 BORNIER
 KLEMMLEISTE
 KLEMMLEISTE

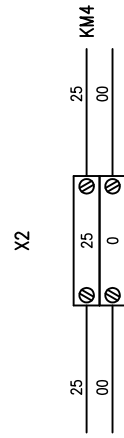
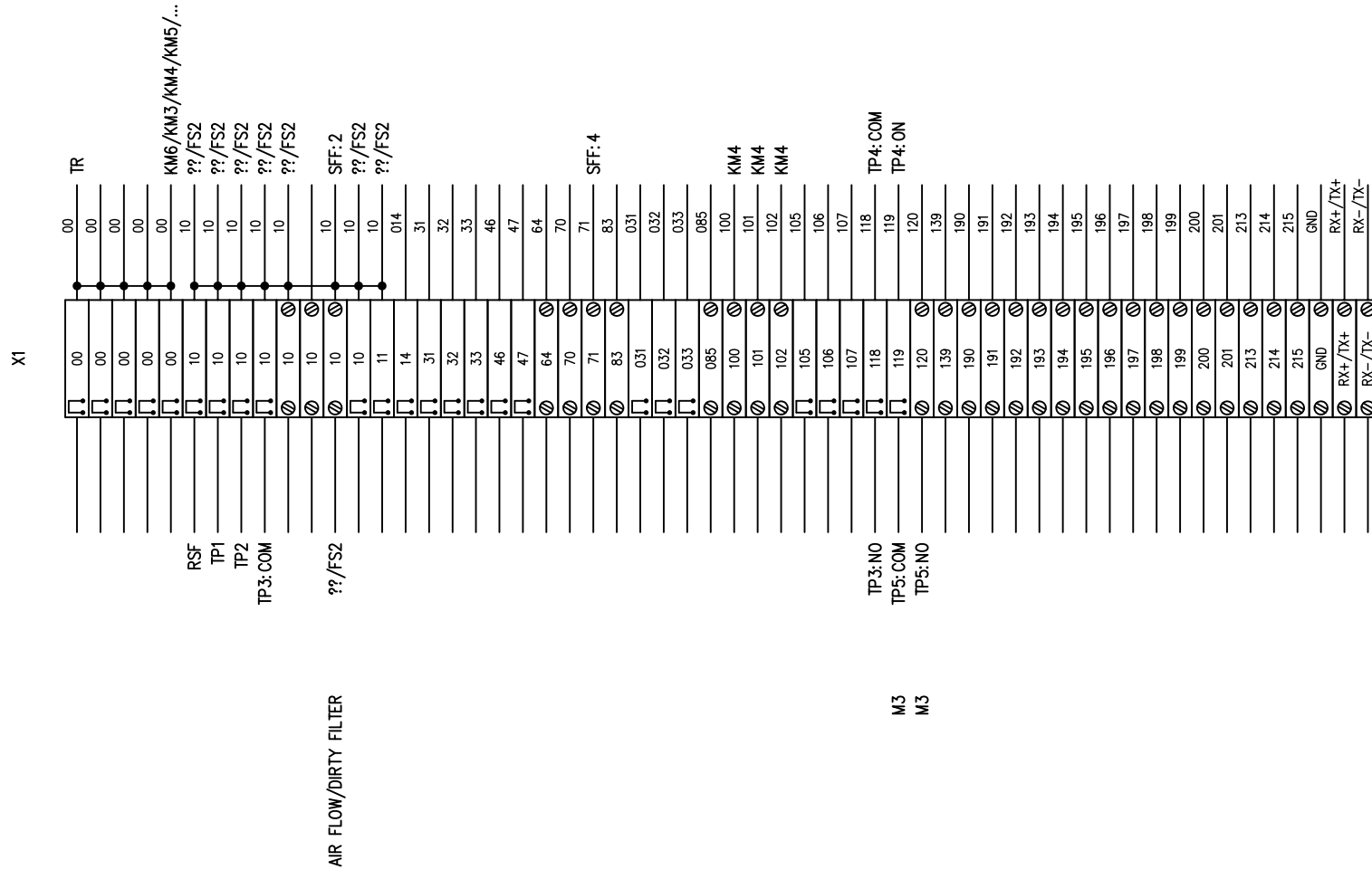

REV.		MODIFICATIONS	DATE	SIGN.	APPR.	M.M.	REPLACE	REPLACE	ORIGIN:	HF620C0302		SHEET 15 OF 20
												CONTINUE 16



HUMID. CONNECTOR

LAYOUT SCHEDA ELECTRONIC BOARD LAYOUT

CONNETTORI PHOENIX A SPINA COMBICON CON PASSO 5.08 mm. COLORE VERDE TIPO MSTB 2,5 :

SIG.	POLI	TIPO	CODICE	SIG.	POLI	TIPO	CODICE
J1	2	2,5/2-ST	17 57 01 9	J11	3	2,5/3-ST	17 57 02 2
J2	5	2,5/5-ST	17 57 04 8	J12	5	2,5/5-ST	17 57 04 8
J3	4	2,5/4-ST	17 57 03 5	J13	5	2,5/5-ST	17 57 04 ^{TR} 8
J4	6	2,5/6-ST	17 57 05 1	J14	3	2,5/3-ST	17 57 02 2
J5	9	2,5/9-ST	17 57 08 0	J15	3	2,5/3-ST	17 57 02 2
J6	4	2,5/4-ST	17 57 03 5	J16	5	2,5/5-ST	17 57 04 8
J7	5	2,5/5-ST	17 57 04 8	J17	3	2,5/3-ST	17 57 02 2
J8	5	2,5/5-ST	17 57 04 8	J18	3	2,5/3-ST	17 57 02 2
J9	3	2,5/3-ST	17 57 02 2				PCOUMID

C1
CONNETTORE FEMMINA 4 VIE AMP 1-480703-0

Pin	Filo	Posizione
1	49	5/C6
2	50	5/C6
3	51	5/C6
4	52	5/C6

TYPE OF SERIAL CARD:
SERIAL CARD RS485
SERIAL CARD RS232
SERIAL CARD LONWORKS
SERIAL CARD pCOWEB

C2
CONNETTORE FEMMINA 4 VIE AMP 1-480703-0

Pin	Filo	Posizione
1	94	7/D4
2	00	7/E4
3	93	7/D7
4	00	7/E7

C3
CONNETTORE FEMMINA 4 VIE AMP 1-480703-0

Pin	Filo	Posizione
1	42	4/E1
2	54	4/E2
3	26	4/E2
4		4/E2

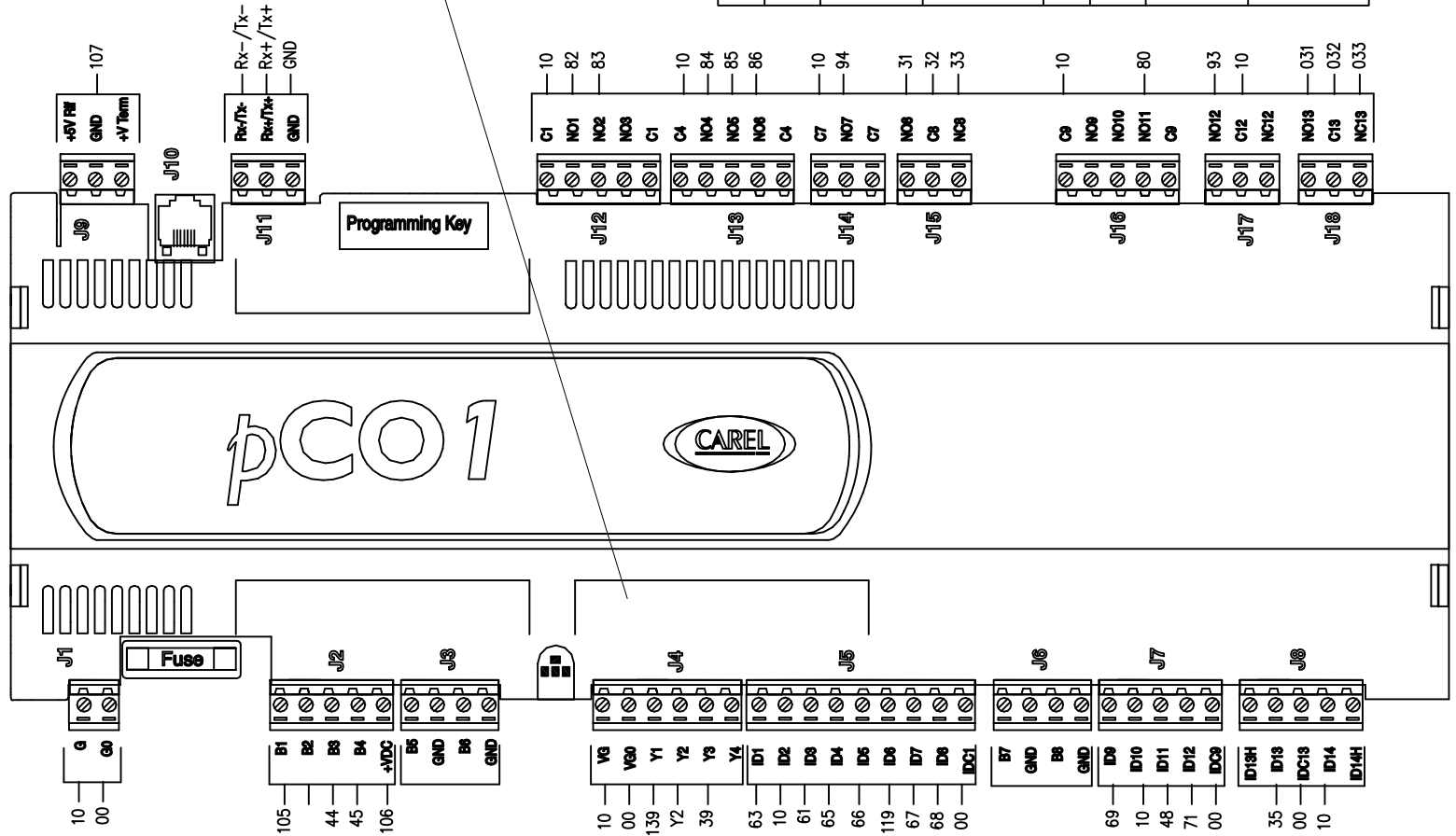

LAYOUT 300...380

F2=USARE MORSETTI PORTAFUBILI PHOENIX
UK5-HESI
INTERBLOCATI

CAVO NPI 4X2,5mmq L=1000mm M1
CAVO NPI 2X1mmq L=1000mm TP3
CAVO NPI 2X1mmq L=1000mm TP4

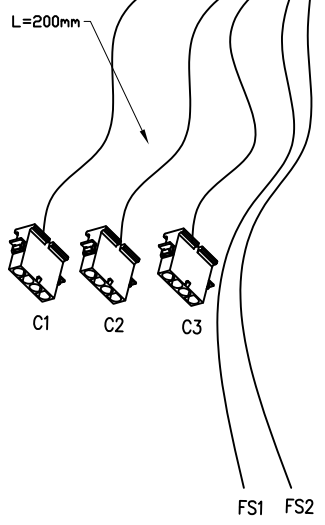
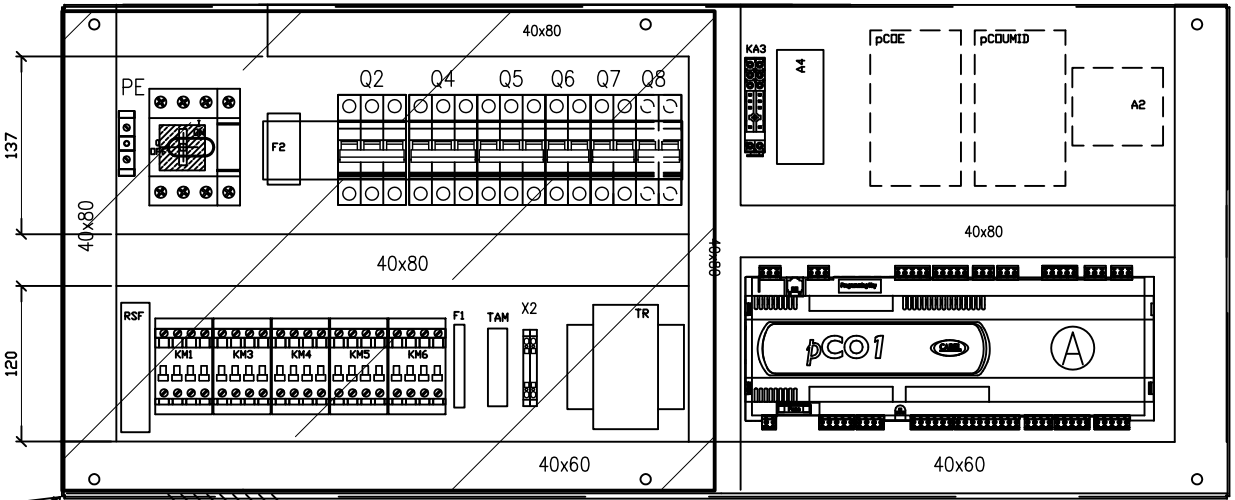
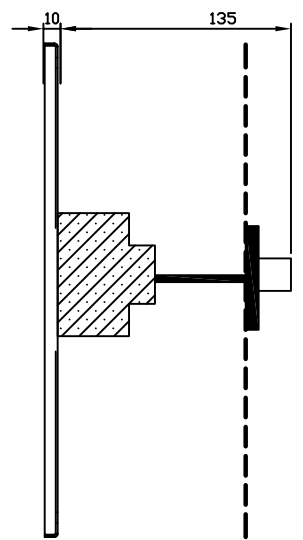

PIASTRA DI FONDO HF17001071

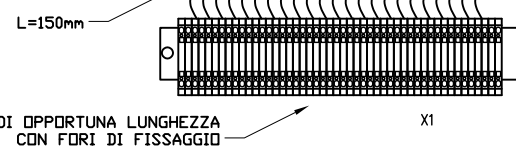

FORNIRE CON GUIDA OMEGA DI OPPORTUNA LUNGHEZZA
CON FORI DI FISSAGGIO

(A) ALZARE SCHEDE CON CAVALOTTO H=200mm

				DATE	14/07/2005								
				DRAW.	P.M.								
				CHECK	P.M.								
REV.	MODIFICATIONS	DATE	SIGN.	APPR.	M.M.	REPLACE	REPLACE	ORIGIN:			HF620C0302		SHEET 17 OF 20
1		2		3		4		5	6	7	8	CONTINUE 18	



LAYOUT

F2=USARE MORSETTI PORTAFUBILI PHOENIX UK5-HESI INTERBLOCATI

CAVO NPI 4X2,5mmq L=1000mm M1

CAVO NPI 2X1mmq L=1000mm TP3

CAVO NPI 2X1mmq L=1000mm TP4

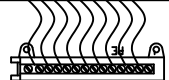
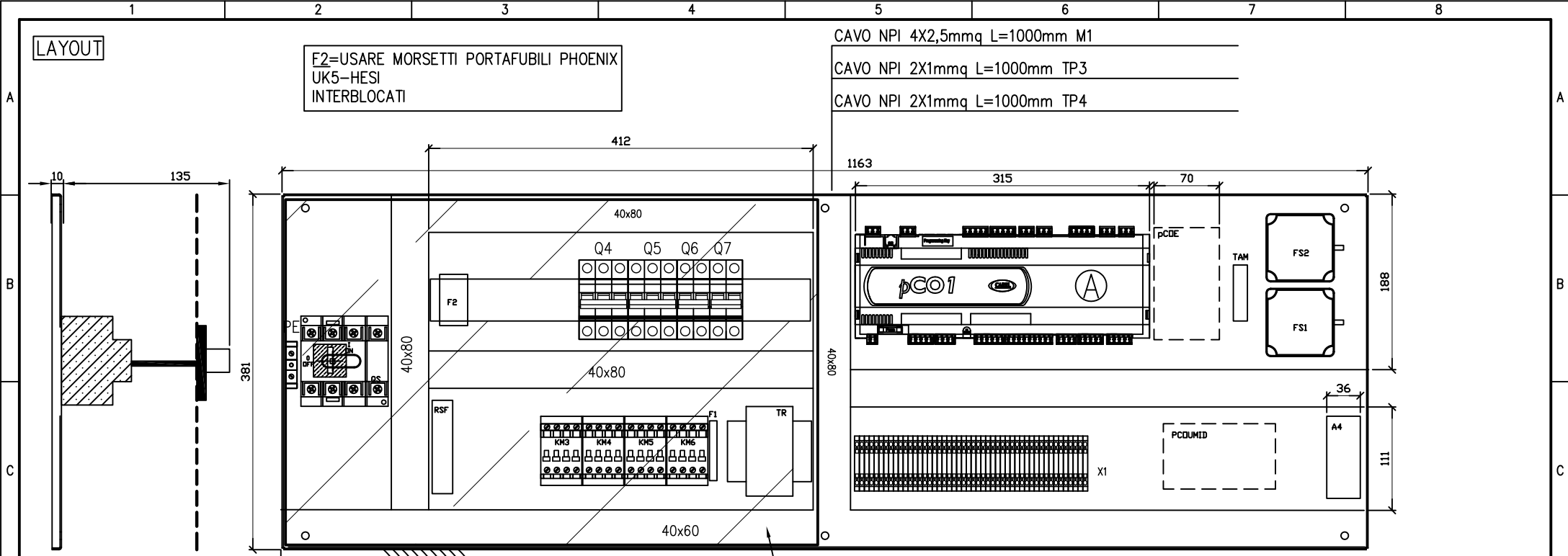

PIASTRA DI FONDO HF17000968

- CAVO NPI 3X2,5mmq L=1500mm K1 FASTON ROSSI
- CAVO NPI 3X2,5mmq L=1500mm K2 FASTON ROSSI
- CAVO NPI 2X0,5mmq L=1500mm K1 FASTON ROSSI
- CAVO NPI 2X0,5mmq L=1500mm K2 FASTON ROSSI

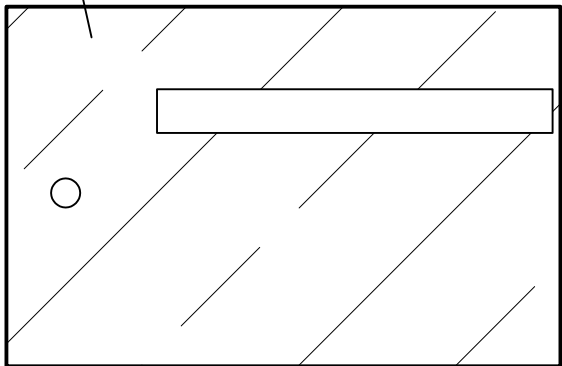

(A) ALZARE SCHEDE CON CAVALOTTO H=200mm

DATE 14/07/2005											
DRAW. P.M.											
CHECK P.M.											
REV.	MODIFICATIONS	DATE	SIGN.	APPR. M.M.	REPLACE	REPLACE	ORIGIN:			HF620C0302	SHEET 18 OF 20
1		2		3		4		5	6	7	CONTINUE 19



1	2		3	4	5	6	7	8			
300...1000	Ref-mark	Function		Technical data	Item code	Description			Amount	M.U.	Position
A	FU1			4AF		FUSIBILE 5X20			1	PCE	3/D08
	KM3	HUMIDIFIER		SIEMENS	3RT1016-1AB01	TELER. 4KW 400V 3P BOB. 24V AC			1	PCE	4/E07
	KM4	EVAP. FANS		SIEMENS	3RT1025-1AB00 3RH1921-1DA11	TELER. 7,5KW 400V 3P BOB. 24V AC CONTATTO AUSILIARIO 1NA+1NC			1	PCE	4/E07
B	KM5	E.H. 1 STEP		SIEMENS	3RT1016-1AB01	TELER. 4KW 400V 3P BOB. 24V AC			1	PCE	6/B03
	KM6	E.H. 2 STEP		SIEMENS	3RT1016-1AB01	TELER. 4KW 400V 3P BOB. 24V AC			1	PCE	6/B03
	M1/M2/M3	EVAP. FANS							1		3/E05
C	Q4	HUMIDIFIER		SIEMENS	5SY6 316-7	INT. AUT. 3P C16A 6KA			1	PCE	3/B07
	Q5	FANS		SIEMENS	5SY6 320-8	INT. AUT. 3P D20A 6KA			1	PCE	3/B07
	Q6	E. HEATING		SIEMENS	5SY6 332-7	INT. AUT. 3P C32A 6KA			1	PCE	3/B07
	Q7	AUX		SIEMENS	5SY6 204-7	INT. AUT. 2P C 4A 6KA			1	PCE	3/B07
D	QS			ABB	OT63E4+OHY2AJ+OXS5X85	SEZ. 4P In= 63A+MANIGLIA+ALBERO (TAGLIATO A 75mm)			1		3/A01
	R1	E. HEATING							1		3/E04
E	RSF	RELE' SEQUENZA FASI							1		3/C02
	SA	ROOM PROBE							1		6/B05
	TR			150VA		CON FUS. A BORDO			1		3/C07
F											
	REV.	MODIFICATIONS	DATE	SIGN.	APPR.	M.M.	REPLACE	REPLACE	ORIGIN:		
									HF620C0302		SHEET 19 OF 20
											CONTINUE 20



DATE 14/07/2005
DRAW. P.M.
CHECK P.M.

HF620C0302

SHEET 19 OF 20

CONTINUE 20

1

2

3

4

5

6

7

8

- NOTE:
- 1) CABLARE Q.E. COME SE FOSSE COMPLETO MA ANDRA INSTALLATO SOLO IL MATERIALE PER VERSIONE SOLO FREDDO
 - 2) PREDISPORRE CABLAGGI PER SCHEDA A1..A2..A3.A4..pCOE E TUTTA LA PARTE DELLA LAN CONNECCION
 - 3) REALIZZARE LASTRA DI PLEXIGLASS A COPERTURA PARTE DI POTENZA (VEDI LAYOUT)

A

A

B

B

C

C

D

D

E

E

F

F

				DATE	14/07/2005														
				DRAW.	P.M.														
				CHECK	P.M.														
REV.	MODIFICATIONS	DATE	SIGN.	APPR.	M.M.	REPLACE	REPLACE	ORIGIN:											

