

section A-A

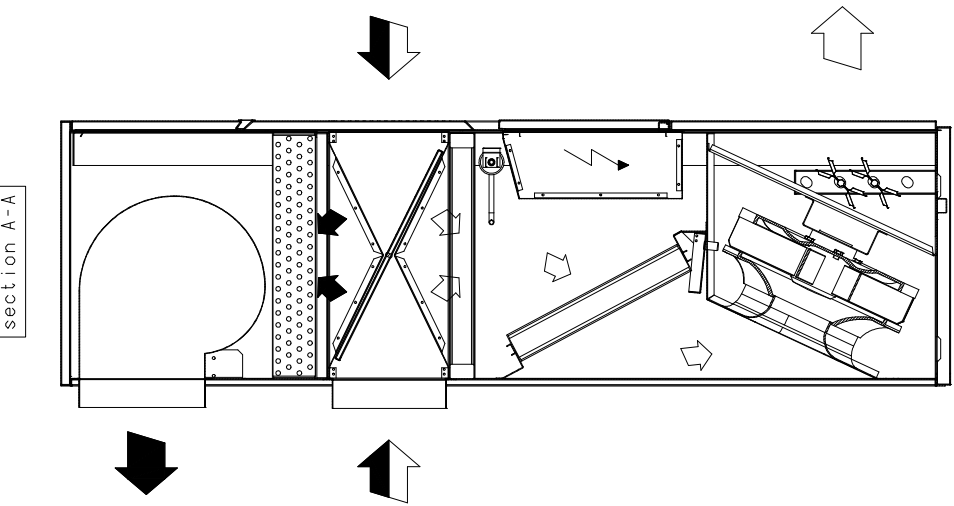

Displacement
VERSION

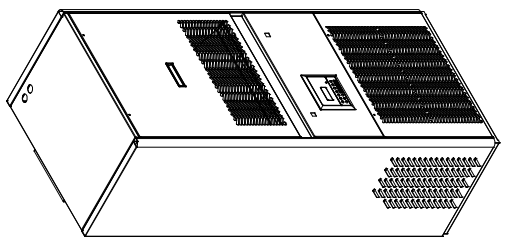
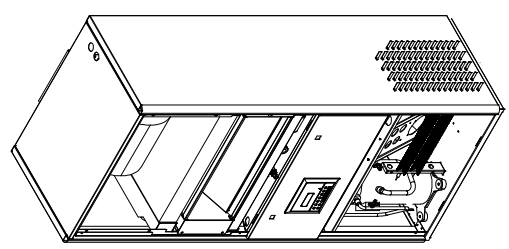
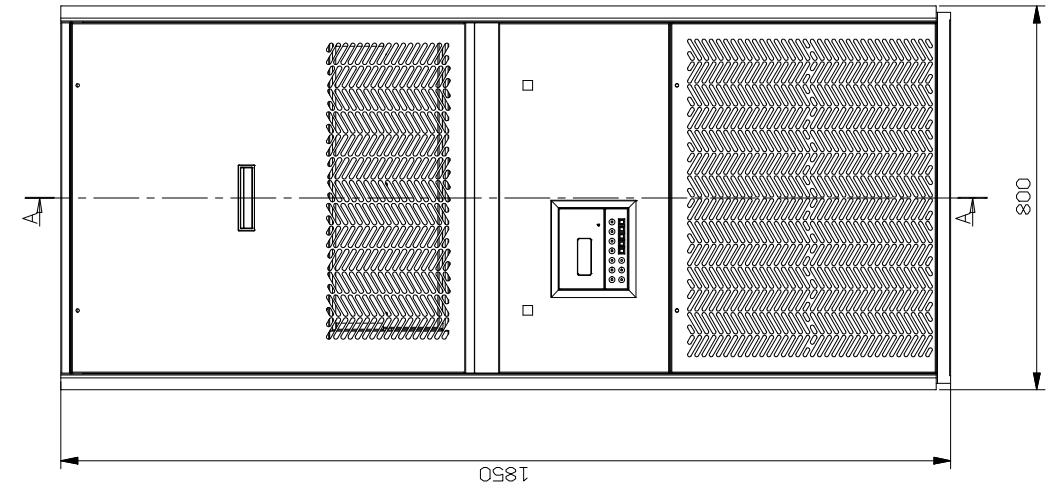
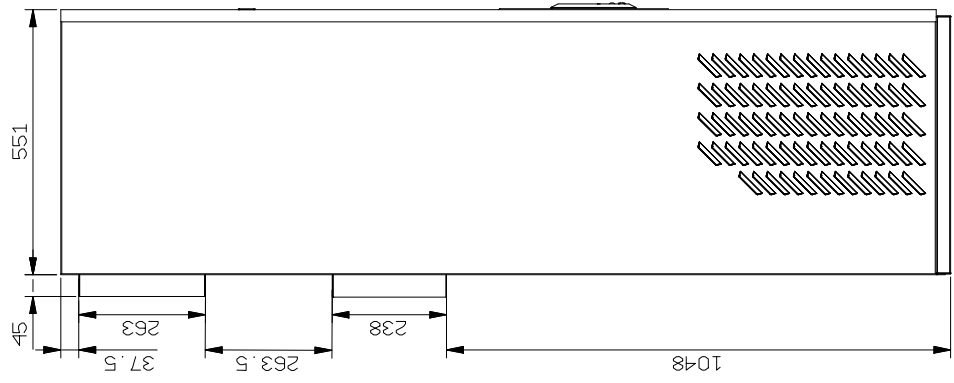
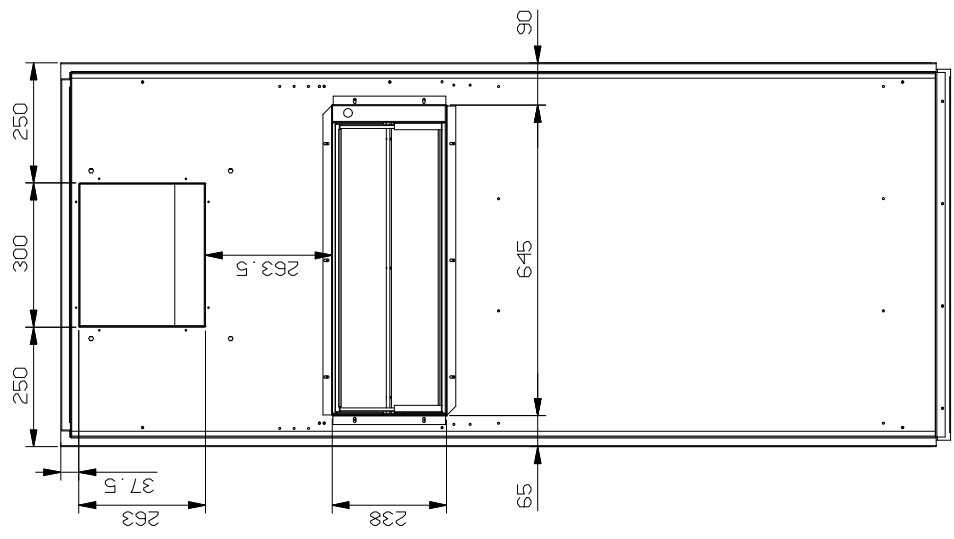

POWER SUPPLY INLET

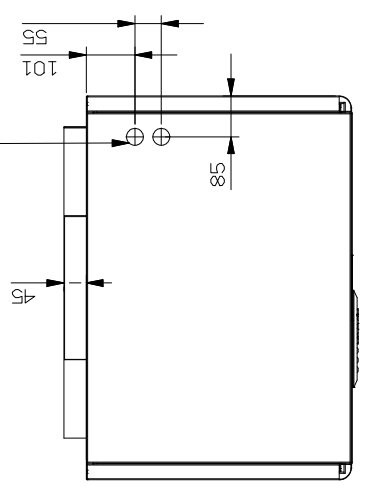

LENNOX		Modifica - Description		Date/Revision/Doc
Revisi	Modifica - Description	Date	Scale	Date/Revision/Doc
01	Prodotto	27/02/06	1:8	
Description - Description		Series	Material	
OVERALL DIMENSIONS		THX	Treatment	
DIMENSIONI INCHIO		Model		
Codice/Design - Code/Design		046-073		
HFG-4000215		Weight		
		Checked		

NOTE: SENZA INDICAZIONE DI TOLLERANZA = GRADO DI PRECISIONE MEDIO = ISO207-63