



Installation, operating and maintenance @DNOVA **pCO² CONTROLLER**



- Providing indoor climate comfort

CONTENTS

<u>1 Type of units controlled</u>	2
<u>2 Regulation logic</u>	3
2.1 Introduction	3
2.2 Temperature control	4
2.3 Energy savings.....	6
<u>3 Start-up and configuration</u>	9
3.1 Display and keyboard: built-in display	9
3.2 Display and keyboard: remote terminal	10
3.3 Starting up the unit for the first time	11
3.4 General description of menus	11
3.4.1 User Menu.....	11
3.4.2 Manufacturer menu	11
<u>4 Alarm management</u>	11
4.1 Description of alarms	11
4.2 Resetting alarms	13
4.3 Alarm history	13
4.4 Alarm table	13
4.4.1 Managing a power failure.....	14
<u>5 Special functions</u>	15
5.1 Units in combined operation.....	15
5.2 Supervision	15
<u>6 Tree structure of menus</u>	16
6.1 Main menu	16
6.2 User menu.....	17
6.3 Alarm menu.....	22
6.4 Alarm history menu	23
6.5 Manufacturer menu	23
<u>7 Architecture of the control system</u>	34
7.1 Layout of microprocessor with or without built-in display	34
7.2 Description of inputs and outputs	35
7.3 Optional cards.....	36
7.3.1 Remote terminal.....	36
7.3.2 RS485 serial card for supervisor system	36
<u>8 Application setting parameters</u>	37
8.1 Table of default values for two indoor units	37
8.1.1 User menu	37
8.1.2 Manufacturer menu	38
<u>9 Technical data</u>	41

1 TYPE OF UNITS CONTROLLED

This manual describes the software application program used to manage the air-conditioning units of modern small and medium-sized telephone shelters.

The units in question are:

- independent direct expansion package air-conditioning units with air-cooled condensers, for outdoor (so-called “backpack-type” units, see *Figure 1*) or indoor (see *Figure 2*) installation;
- air conditioners comprising an indoor evaporating unit and an outdoor air-cooled motor condenser unit.

The units are equipped with a Carel pCO² Small programmable microprocessor with or without built-in display and it's possible to connect a remote terminal.



Figure 1: Outdoor unit

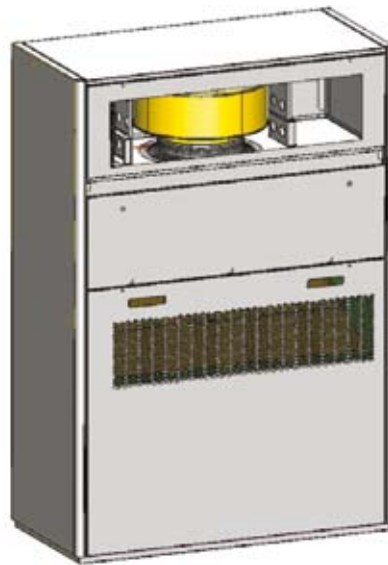

Figure 2: Indoor unit

In this type of system the resources available for each unit are:

- mechanical cooling
- air recirculation fan
- electric heating element
- air flow diverter

The figure here on the right shows a cross section of the outdoor package unit.

There is a possibility of using two units of the same type in combination according to a master/slave configuration as described in section 5.1 *Units in combined operation*.

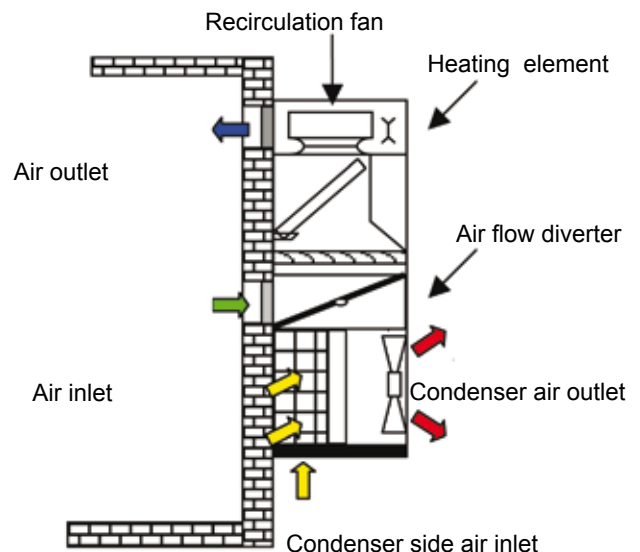

2 REGULATION LOGIC

2.1 Introduction

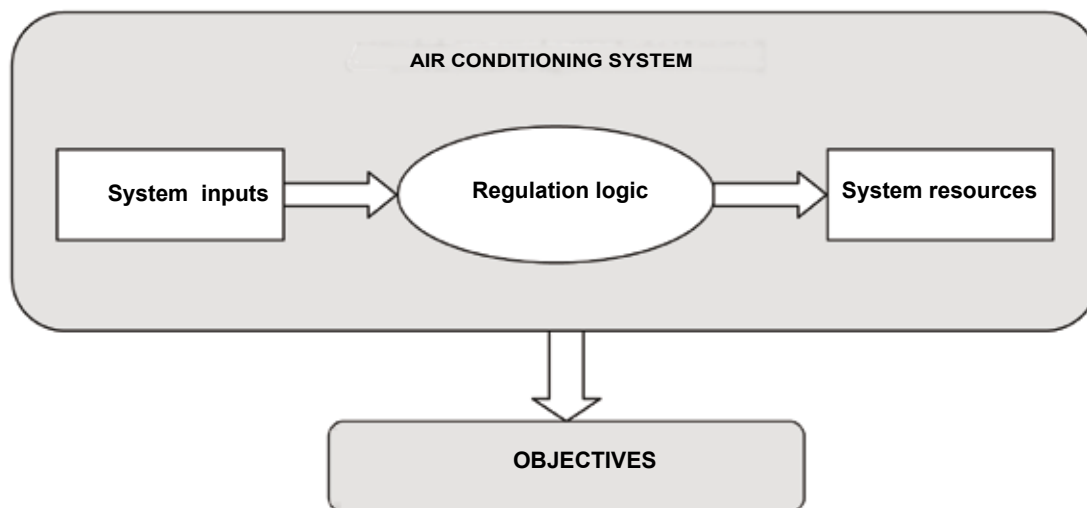

Obectives

The objectives of the air conditioning system are:

- to control temperature
- to save energy
- to manage alarm situations

System inputs

The units are equipped with several probes (duly positioned) for measuring fundamental conditions (temperature and pressure). The system inputs are thus:

- ambient temperature (inside the shelter)
- outdoor temperature
- outlet air temperature
- condensation pressure

System resources

The system resources are:

- mechanical cooling
- air recirculation fan
- electric heating element
- air flow diverter

Regulation logic

The regulation logic receives the system inputs, processes the information gathered and decides how to use the available resources in order to achieve the set objectives.

2.2 Temperature control

The objective is to maintain temperature conditions (minimum, normal and emergency), taking into account both outdoor factors and internal ones such as loads generated by telephone equipment and the electricity supply.

The temperature is controlled on the basis of the ambient temperature and the mechanical cooling and heating element functions can be managed with step regulation. If the system comprises two units, a multiple-step regulation may be used; in this case the master unit is assigned control over the entire system. (See Section 5.1 Units in combined operation)

Mechanical cooling

The mechanical cooling function is mainly ensured by the starting up of the air conditioning unit compressor. *Figure 2* shows a functional diagram referring to the outdoor unit.

The compressor start-up follows the logic shown in *Figure 2*.

It is possible to set the condensation fan to start up in advance to prevent high pressure conditions from occurring when the unit itself is started up.

If the system comprises two independent units in the combined operating mode (C1 and C2), the units are controlled according to the logic illustrated in *Figure 2*.

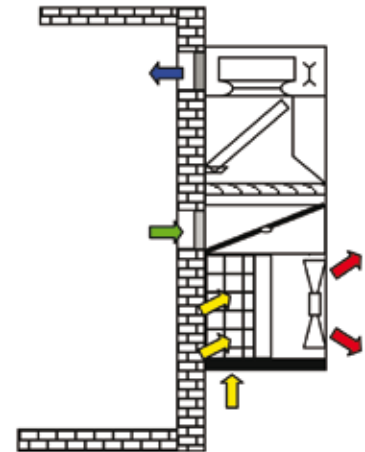

Figure 2: Mechanical cooling

- 1 = Compr. On
- 0 = Compr. Off

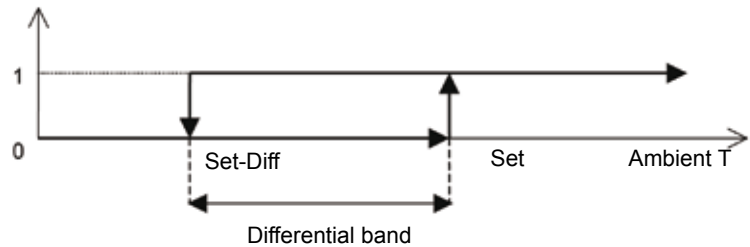

Figure 2: Compressor start-up logic

- 2 = C1 & C2 On
- 1 = C1 On & C2 Off
- 0 = C1 & C2 Off

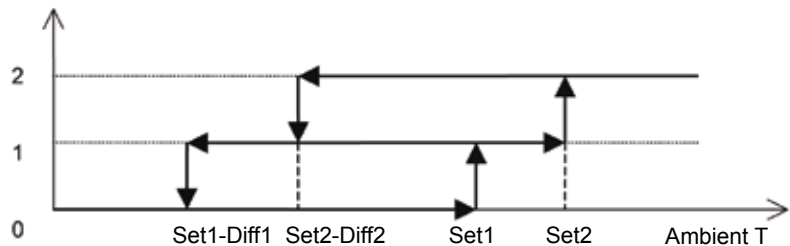

Figure 2: Compressor start-up logic in combined operation

Heating with heating element

The heating function is ensured by the turning on of the heating element. *Figure 2* shows a functional diagram referring to the outdoor unit.

The air-conditioning unit's heating element turns on according to the logic shown in *Figure 2*. In the heating mode, the air flow diverter is set in the recirculation position.

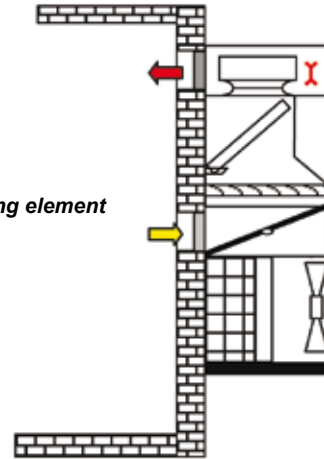

Figure 2: Heating with heating element

1 = Heat. elem. On
 0 = Heat. elem. Off

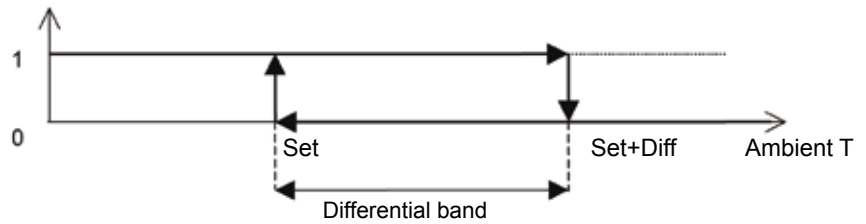

Figure 2: Heating element switching on logic

If the system comprises two independent units in combined operation, the heating elements (R1 and R2) are controlled according to the logic illustrated in *Figure 2*.

2 = R1 & R2 On
 1 = R1 On & R2 Off
 0 = R1 & R2 Off

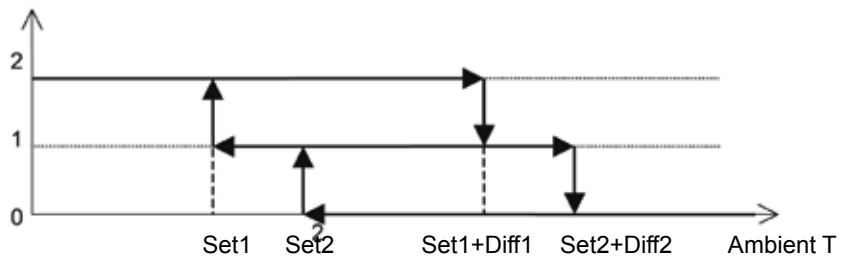

Figure 2: Heating element switching on logic in combined operation

Condensation control

The condensation fans are regulated according to the condensation pressure read by a specific transducer, with proportional control based on a differential band delimited by the upper and lower limits (L1 and L2), see *Figure 2*.

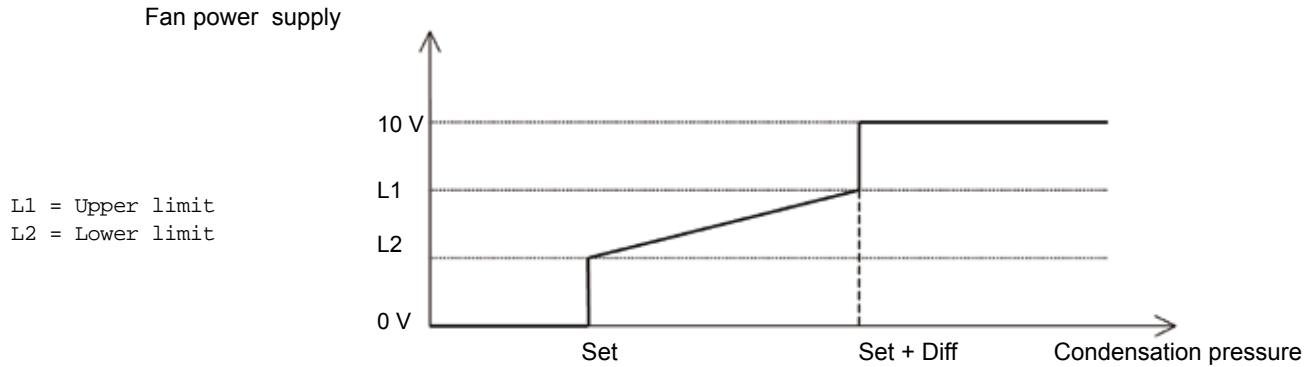

Figure 2: Condensation control logic

2.3 Energy savings

To achieve significant energy savings in the system’s management, each air conditioner can use outdoor air when the latter has favourable thermal characteristics. In this way the energy content of outdoor air can be exploited to obtain what is referred to as “free cooling” (i.e. at no expense). *Figure 2* shows a functional diagram referring to the outdoor unit.

The free-cooling (F.C.) function is enabled when the difference between the ambient temperature (T_a) and outdoor temperature (T_e) reaches the programmed setpoint (Set). To avoid possible oscillations in the free-cooling enabling status, a differential band (Diff) may also be set. To prevent the inflow of excessively cold air into the shelter the F.C. function is disabled if the outlet air temperature falls below the set limit.

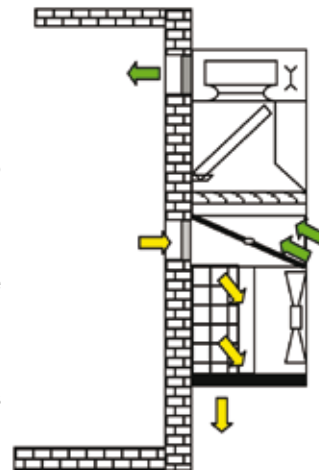

Figure 2: Completely free cooling

For the purpose of this function, the evaporating section fan can be made to operate either in an open cycle (free-cooling) or closed cycle (recirculation) by adjusting the position of an air flow diverter.

The free-cooling enabling logic is illustrated in *Figure 2*.

- 1 = F.C. On
- 0 = F.C. Off

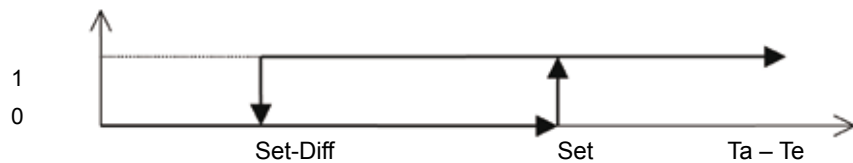

Figure 2: Free-cooling enabling logic

If the system comprises two units (see Section 5.1 Units in combined operation) the master unit enables the free-cooling mode in the slave unit if the ambient temperature is higher than the programmed setpoint, according to the logic shown in Figure 2.

1 = F.C. slave enabl.
 0 = F.C. slave disabl.

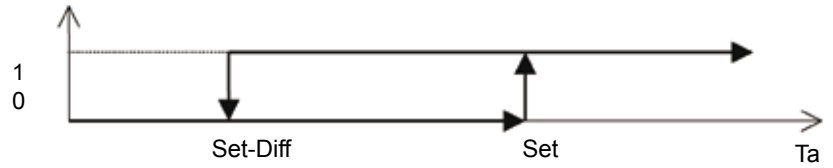

Figure 2: Free-cooling enabling logic in the slave unit

The minimum temperature of the air entering the shelter is controlled by modulating the movement of the diverter according to the value read by the probe situated on the air outlet. A partial free-cooling function is active at this stage.

Figure 2 shows a functional diagram referring to the outdoor unit.

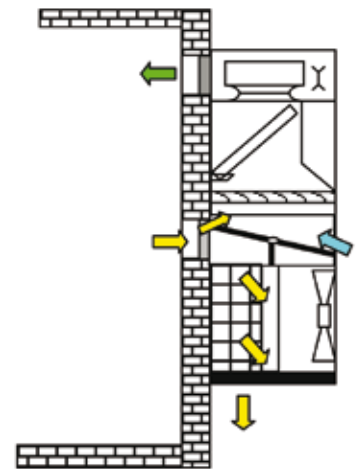

Figure 2: partial free-cooling

100% = Free Cooling

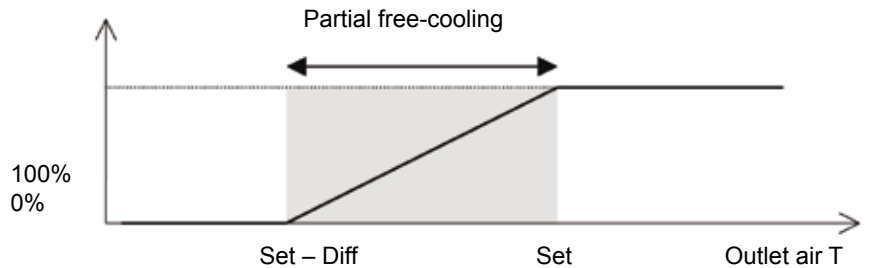

Figure 2: Air flow diverter modulation logic in partial free-cooling

The operating logic is illustrated in Figure 2.

Simultaneous operation: mechanical cooling and free-cooling

Ambient and outdoor temperature conditions may imply simultaneous operation in the mechanical cooling and complete or partial free-cooling modes. Figure 2 shows a functional diagram referring to the outdoor unit.

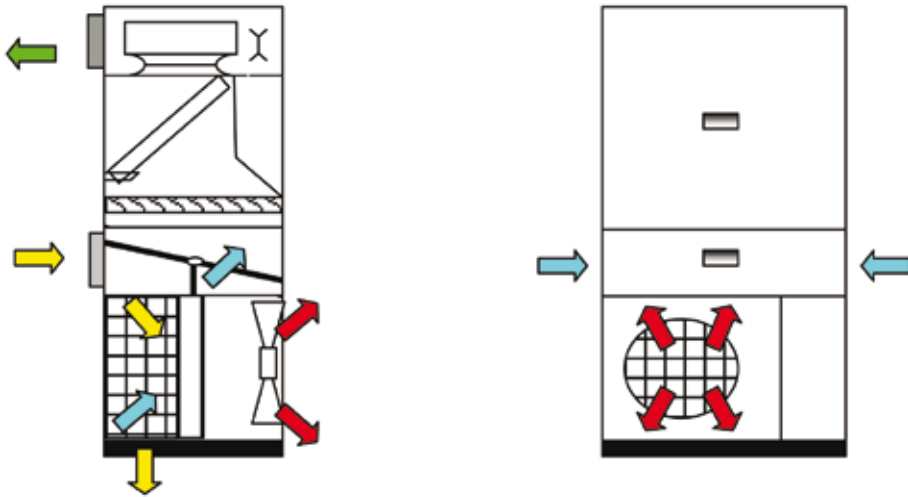
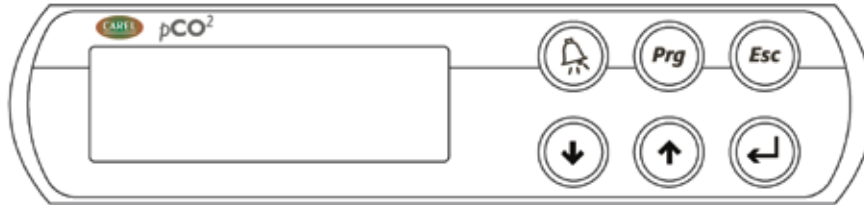

Figure 2: Simultaneous operation

3 START-UP AND CONFIGURATION

3.1 Display and keyboard: built-in display

In the version with built-in display, the microprocessor control is equipped with a 4x20 backlit LCD terminal (see Fig.) for starting the unit, displaying the equipment status and setting the configuration parameters.



The keyboard has six backlit buttons:

Some functions can be accessed by pressing two buttons simultaneously: + , + and + .

By pressing and simultaneously you can display in succession the masks (display pages) contained in the menus and change numerical parameters. A cursor can be seen in the top left corner.

By pressing it is possible to move the cursor into the fields containing parameters that may be modified. Pressing the button again will cause the value entered to be saved and the cursor will move into the next field or to the starting position.

Pressing takes you back to the main menu.

The button (backlit with red light) lights up whenever an alarm occurs. When the button is pressed the type of alarm is displayed. Pressing the button a second time will reset the alarms. If the cause of the alarm persists, the signal will reappear.

The button provides access to the user menu for configuring the unit; access is protected by a user password.

Pressing + provides access to the manufacturer menu for operations to be performed exclusively by service engineers; access is protected by a manufacturer password.

Pressing + provides access to the alarm history; the last ten alarms that occurred are stored according to a FIFO logic.

By holding + pressed down together and using the and keys it is possible to adjust the display contrast.

3.2 Display and keyboard: remote terminal

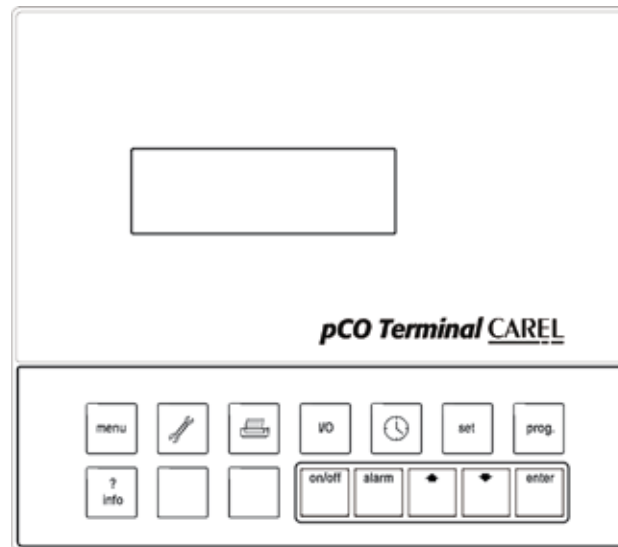

Figure 2: Remote terminal display and keyboard

The microprocessor control (both the version with built-in display and the version without local display) can be connected to a remote terminal (see Section 7.3.1 Remot for connection instructions). The keyboard shown in Figure 2 has 15 keys, only 6 of which are active. These keys have the same functions as the buttons on the microprocessor control with built-in display; the correspondences are shown below:

DESCRIPTION	BUILT-IN KEYBOARD	REMOTE TERMINAL
Alarm		alarm
Prog		prog.
Esc		menu
Down		
Up		
Enter		enter

Note: in the explanation below, reference is made to the version with built-in display.

3.3 Starting up the unit for the first time

When the power supply is connected to the microprocessor control, the first main menu page will appear. It contains the following information:

- ambient air temperature (Tint);
- outlet air temperature (Tsup);
- outdoor air temperature (Text);
- fan and compressor status;
- hours of operation of the treatment fans and compressors.

main (m.1)

```

Comp OFF Tint 00.0C
Evap OFF Tsup 00.0C
Cond OFF Text 00.0
Ev 00000 Comp 00000h
    
```

From the next mask (m_on_off) it is possible to turn the unit on and off. It will also be indicated whether the unit is master or slave and if is on LAN or STAND ALONE

m_on_off (m.2)

```

UNIT ON:
No
Slave
STAND ALONE
    
```

3.4 General description of menus

3.4.1 User Menu

The user menu is accessed by pressing the Prg button. It contains the masks for configuring the usage parameters of the unit; access is protected by a user password, which is initially set as follows:

User password: 108

The password can subsequently be changed from the m_pw_user mask (m. 38).

3.4.2 Manufacturer menu

For a detailed illustration of all accessible masks, see chapter 6. Tree structure

The Manufacturer menu is accessed by pressing Prg+Esc together. It contains the masks for configuring the operating parameters of the unit; access is protected by a manufacturer password; changes may only be made by service engineers. **The password is available on request.**

4 ALARM MANAGEMENT

4.1 Description of alarms

The application manages the alarms that are detected and processed by the microprocessor in order to indicate them on the display and remotely.

Section 6.3 *Alarm menu* provides a complete list of the masks for configuring alarms along with their description.

4.1.1 Display alarms

Display alarms are:

- minimum temperature alarm
- high and maximum ambient temperature alarm
- fan fault alarm
- high pressure alarm
- low pressure alarm
- air flow alarm
- dirty air filters alarm
- free-cooling or heating element fault alarm
- electric heater overload alarm
- compressor maintenance alarm
- evaporator fan maintenance alarm
- pressure probe fault alarm
- temperature probe fault alarm
- LAN alarm

4.1.2 Remote alarms

You can find the following alarms on the terminal block:

Function separated alarms switched off (you can select this function in the mask `m_allarmi_separ`)

- functional alarm
- block fault alarm

ON LAN UNIT	STAND- ALONE UNIT
Functional alarm	Functional alarm
minimum temperature alarm	minimum temperature alarm
high temperature alarm	high temperature alarm
air flow alarm	dirty air filters alarm
high pressure alarm	free-cooling or heating element fault alarm
low pressure alarm	temperature probe fault alarm
dirty air filters alarm	
free-cooling or heating element fault alarm	
temperature probe fault alarm	
Block fault alarm	Block fault alarm
maximum temperature alarm	maximum temperature alarm
air flow alarm on both the two units	air flow alarm
high pressure alarm on both the two units	high pressure alarm
low pressure alarm on both the two units	low pressure alarm

Function separated alarms switched on

- air flow alarm
- free-cooling or heating element fault alarm
- high or low temperature alarm
- high or low pressure alarm
- dirty air filters alarm

4.2 Resetting alarms

Alarms may be either automatically or manually reset. In the case of automatically reset alarms, when the cause of the alarm disappears the unit will automatically resume normal operation. Only the red light of the Alarm button will remain on; pressing the button itself will turn it off. In the case of manually reset alarms, the unit will remain in an alarm status until the Alarm button is pressed twice. The resetting mode of each individual alarm is configured from the manufacturer menu (see section 6.5 *Manufacturer menu*)

4.3 Alarm history

The alarms detected by the microprocessor are recorded according to their functional priorities and stored in an alarm history. Pressing Prog+Alarm together provides access to the alarm history menu. The progressive number, time, date and code of the last ten alarms to have occurred are memorised on a FIFO basis (first in – first out). From the user menu it is possible to call up the description of an alarm in reference to its code. This function is enabled from the m_legenda (legend) mask.

al_story_01 (m.83)

```

Storico Allarmi (1)
00:00 00/00/00
codice: AL00
    
```

Buzzer

With the remote display a buzzer can be enabled to signal alarms (m_buzzer mask m. 154).

4.4 Alarm table

Mask		Code	Description	Troubleshooting tips
Name	No.			
m_no_alarm	m.61	_	No alarm active	
m_al_probe_01	m.62	AL01	B1 outlet pressure probe fault	Check electrical wiring of probe or replace probe.
m_al_probe_03	m.63	AL02	Shelter internal temp. probe fault	Check electrical wiring of probe or replace probe.
m_al_probe_04	m.64	AL03	Outlet air temp. probe fault	Check electrical wiring of probe or replace probe.
m_al_probe_05	m.65	AL04	Shelter outdoor temp. probe fault	Check electrical wiring of probe or replace probe.
m_al_hp_sonda	m.66	AL06	High pressure, alarm activated by probe	Check whether the condenser fan is working properly. Clean condenser coil.
m_al_hp_ps	m.67	AL06	High pressure, alarm activated by pressure switch	Check whether the condenser fan is working properly. Clean condenser coil.
m_al_lp_ps	m.68	AL07	Low pressure, alarm activated by pressure switch	Check whether the evaporator fan is working properly. Check the refrigerant level.
m_al_flusso	m.69	AL08	Air flow insufficient or absent	Check whether the evaporator fan is working properly.
m_al_filtri	m.70	AL09	Dirty filters	Clean the air filter

m_al_comp	m.71	AL10	Compressor thermal switch tripped	pLAN fault! Check address and connection cable
m_al_res	m.72	AL11	High temperature in heating elements	Check whether the compressor is working properly. Check the safety thermostat positioned on
m_al_senso_fasi	m.73	AL12	Phase direction three-phase power	the heating element. Check whether the evaporator fan is working
m_al_alta_temp	m.74	AL13	supply / no power	properly.
m_al_max_temp	m.75	AL14	High temperature in shelter (40 C)	Invert two phases of the 400V power supply
m_al_min_temp	m.76	AL15	Maximum temperature in shelter (50 C)	/ Check whether the power is on
m_al_anom_fc	m.77	AL16	Minimum temperature in shelter	- -
m_al_fun_comp	m.78	AL17	Free-cool. or heating element fault. Compr. operating time limit exceeded.	- Check the efficiency of the diverter motor.
m_al_fun_evap	m.79	AL18	Urgently requires maintenance!	Check the efficiency of the heating element Check whether the compressor is working
m_al_speed_evap	m.80	AL19	Evap. operating time limit exceeded.	properly.
m_al_p_min_mand	m.81	AL20	Urgently requires maintenance!	Check whether the evaporator fan is
m_al_plan	m.82	AL21	Evap. fan speed set below minimum Minimum outlet pressure	working properly. Check manufacturer parameters. Check refrigerant level.

Check the pLan address on the microprocessor.
Check pLan cable connection

4.4.1 Managing a power failure

If the telephone shelter is equipped with an integrated emergency power supply station it is possible to set a function for managing mains power failures, which is useful in the case of high outdoor temperatures. In this case the microprocessor and evaporating fan will continue operating to ensure that air is recirculated inside the shelter; the free-cooling function may be enabled as appropriate.

It is also possible to enable a function for managing the return of the mains power supply. This special management function is illustrated in Figure 2, where t1 is the amount of time in advance the condenser starts, t2 is the operating time of the diverter and t3 is the special management time. After time t3 has elapsed, standard regulation is resumed.

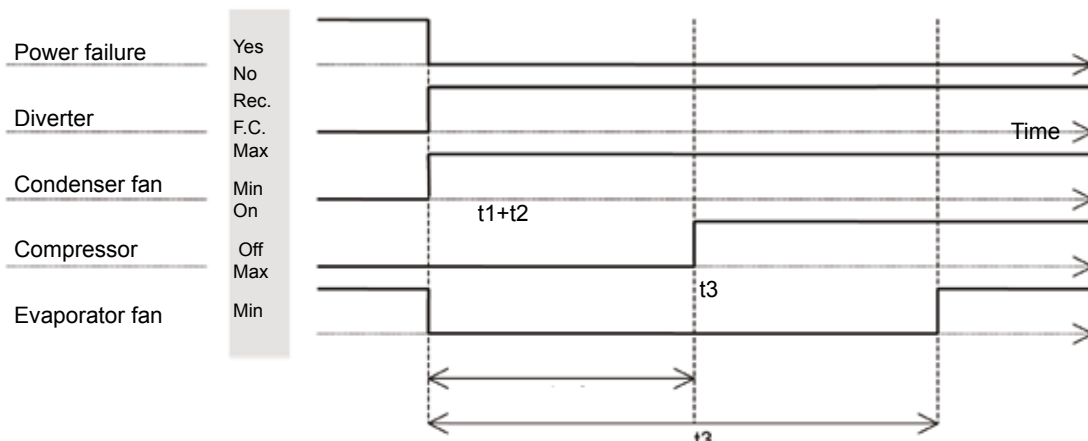

Figure 2: Time sequence of power failure management function

5 SPECIAL FUNCTIONS

5.1 Units in combined operation

If the system is made up of two units, they can be connected in a local network (LAN) using a standard RS485 serial cable and Carel proprietary protocol for pCO series microprocessors, denominated pLAN.

Configuration The microprocessor dipswitches must be configured with the unit's pLAN address (e.g. 1 for unit 1 and 2 for unit 2).



Operating logic: master/slave

The two units connected in the pLAN are managed according to a master/slave logic. The master/slave roles are switched daily (the frequency may be set from the manufacturer menu).

The master unit activates the slave unit in the following cases:

- when the ambient temperature of the second cooling setpoint is reached (see Figure 2).
- when the ambient temperature of the second heating setpoint is reached (see Figure 2).

Free-cooling in a slave unit The master unit can enable the slave unit to operate in the free-cooling mode in the following cases:
the right internal temperature conditions present themselves (see section 2.3 Energy);

5.2 Supervision

The air conditioning units can be connected to a supervisor system through a serial network (RS485). Communication can take place through the Carel proprietary protocol, MODBUS RTU protocol (RS485 network) or LonWorks protocol (FTT or RS485 network).

Configuration

To make the serial connection, it is necessary to install a specific serial card, available on request, in the microprocessor. In addition, the serial addresses of the units must be configured from the specific masks in the manufacturer menu (see mask m__superv_02 m.157).

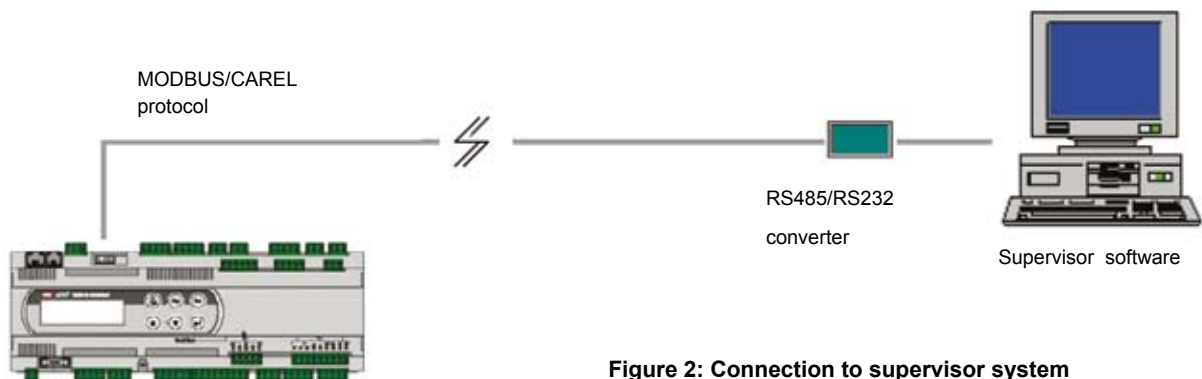

Figure 2: Connection to supervisor system

6 TREE STRUCTURE OF MENUS

For directions on how to navigate through the menus and change parameters, see chapter 3 *Start-up and configuration*.

6.1 Main menu

(Esc button)

main (m.1)

```

Comp OFF Tint 00.0C
Evap OFF Tsup 00.0C
Cond OFF Text 00.0C
Ev 00000 Comp 00000h
    
```

This is the main mask. It is described in section 33 Starting up the unit for the first time

m_on_off (m.2)

```

UNIT ON:
      No
slave
    
```

From this mask it is possible to turn the unit on and off; the status (master or slave) of the unit is likewise displayed.

m_cons_rem (m.3)

```

Remote Contact
enabled
    
```

This mask indicates whether the remote control digital input is enabled.

m_val_01 (m.4)

```

Condensing pressure
      00.0 bar
    
```

This mask displays the condensation pressure in bars.

m_clock (m.5)

```

System date and time
00:00 00/00/00
    
```

This mask displays the current date and time.

Debug masks

The four masks below show whether the debugging function is enabled in the m_debug_01 mask of the user menu.

m_io_01 (m.6)

```

Analog input
cond. pres. 00.0 bar
    
```

The analog inputs are displayed here: condensation pressure and evaporation pressure.

m_io_02 (m.7)

```

Digital Input
1:C 2:C 3:C 4:C
5:C 6:C 7:C 8:C
    
```

The digital inputs are displayed here (O = open = alarm ON, C = closed = alarm OFF).

m_io_03 (m.8)

```

Digital Output
1: OFF 2: OFF 3: OFF
4: OFF 5: OFF 6: OFF
7: OFF 8: OFF
    
```

The digital outputs are displayed here (ON - OFF).

m_io_04 (m.9)

```

Analog Output
Y1: 000.0 %
Y2: 000.0 %
Y3: 000.0 %
    
```

The analog outputs are displayed here in percentages:
 Y1: condensation fan;
 Y2: evaporation fan;
 Y3: free-cooling diverter

information mask

info (m.10)

```

LENNOX
Ver.: SHELTER-ENG-01
Date: 04/11/02
    
```

This mask shows: the application code and version as well as the issue date.

6.2 User menu

(PRG button)

pw_user (m.11)

```

User Menu
Password: 0000
    
```

Access to the user menu is protected by a password that can be changed from the m_pw_user mask

m_user (m.12)

```

User Menu
abilitato ...
    
```

Entering the correct user password enables user menu.

m_fc_01 (m.13)

```

Free-Cooling
Set : 00.0 C
Diff.: 00.0 C
    
```

The temperature setpoint and differential band for controlling the free-cooling function are entered in this mask.

m_fc_02 (m.14)

```

Free-cool. slave
enable: Set : 00.0 C
Diff: 00.0 C
    
```

The temperature setpoint and differential band for controlling the slave unit free-cooling function are entered in this mask.

m_res_01 (m.15)

```

Heating
Set 1: 00.0 C
Diff. 1: 00.0 C
    
```

The temperature setpoint and differential band for controlling the master unit heating element are entered in the mask.

m_res_02 (m.16)

Heating Set 2: 00.0 C Diff. 2: 00.0 C

The temperature setpoint and differential band for controlling the slave unit heating element are entered in this mask.

m_raff_01 (m.17)

Cooling Set 1: 00.0 C Diff. 1: 00.0 C

The temperature setpoint and differential band for controlling the first compressor (according to the FIFO rule) are entered in this mask.

m_raff_02 (m.18)

Cooling Set 2: 00.0 C Diff. 2: 00.0 C
--

The temperature setpoint and differential band for controlling the second compressor (according to the FIFO rule) are entered in this mask.

m_imm_01 (m.19)

Supply air temp. Set : 00.0 C Diff.: 00.0 C

In this mask it is possible to enter the temperature setpoint and differential band for modulating the diverter according to the outlet air temperature.

al_alta_temp_01 (m.20)

High temperature alarm enable: No

In this mask it is possible to enable the shelter high internal temperature alarm.

al_alta_temp_02 (m.21)

High temperature alarm: Set : 00.0 C Diff: 00.0 C
--

If the high temperature alarm has been enabled (al_alta_temp_01 mask) the temperature setpoint and differential band can be set here.

al_alta_temp_03 (m.22)

High temperature alarm delay: 0000 s

In this mask it is possible to set a delay in the signalling of the high temperature alarm.

al_max_temp_01 (m.23)

Max temperature alarm enable: No

In this mask it is possible to enable the shelter maximum internal temperature alarm.

al_max_temp_02 (m.24)

Max temperature al. Set : 00.0 C Diff: 00.0 C

If the maximum temperature alarm has been enabled (al_max_temp_02 mask) the temperature setpoint and differential band can be set here.

al_max_temp_03 (m.25)

Max temperature
alarm delay:
0000 s

In this mask it is possible to set a delay in the signalling of the maximum temperature alarm.

al_min_temp_01 (m.26)

Min temperature
alarm enable:
No

In this mask it is possible to enable the shelter minimum internal temperature alarm.

al_min_temp_02 (m.27)

Min temperature al
Set : 00.0 C
Diff: 00.0 C

If the minimum temperature alarm has been enabled (al_min_temp_01 mask) the temperature setpoint and differential band can be set here.

al_min_temp_03 (m.28)

Min temperature
alarm delay:
0000 s

In this mask it is possible to set a delay in the signalling of the shelter minimum internal temperature alarm.

If the ambient temperature is greater than or equal to a set value, Set 1 (T_{amb} ≥ Set1), and the outlet air temperature exceeds the ambient temperature by a set amount, Set 2 (T_{outlet} – T_{amb} > Set 2), a free-cooling or heating element fault is signalled; the parameters of this function are set in masks al_anom_fc_01, al_anom_fc_02 and al_anom_fc_03.

al_anom_fc_01 (m.29)

Free-cool. fault
or heater alarm
enable:
No

In this mask it is possible to enable the alarm function for free-cooling system or heating element faults.

al_anom_fc_02 (m.30)

Free-cool. fault
or heater alarm
set : 12.0 C
Diff: 00.0 C

The ambient temperature alarm parameters are set in this mask.

al_anom_fc_03 (m.31)

Free-cool. fault
Tsup-Tint condition:
Set : 02.0 C
Diff.: 00.0 C

The outlet air and ambient temperature alarm parameters are set in this mask.

al_anom_fc_04 (m.32)

Free-cool. fault
alarm delay:
0000 s

If the free-cooling or heating element fault alarm has been enabled (al_anom_fc_01 mask) a delay time may be set here.

m_ore_comp_01 (m.33)

Compressor
maintenance alarm
enable: No

In this mask it is possible to enable an alarm that will trip when the compressor operating threshold is exceeded.

m_ore_comp_02 (m.34)

Comp. running time
Hours: 00000 h
Threshold: 00000 h
Reset : No

If the compressor operating threshold exceeded alarm has been enabled (m_ore_comp_01 mask) this mask will display the hours of operation of the compressor as well as the threshold value; the hour meter can also be cleared.

m_ore_evap_01 (m.35)

Evaporator
maintenance alarm
enable: No

In this mask it is possible to enable an alarm that will trip when the evaporator operating threshold is exceeded.

m_ore_evap_02 (m.36)

Evap. running time
Hours: 00000 h
Threshold: 00000 h
Reset : No

If the evaporator operating threshold exceeded alarm has been enabled (m_ore_evap_01 mask) this mask will display the hours of operation of the evaporator as well as the threshold value; the hour meter can also be cleared.

m_debug_01 (m.37)

Debug masks enable:
No

From this mask it is possible to enable the debugging masks to allow a complete display of the microprocessor inputs and outputs (masks m_io_01, m_io_02, m_io_03 and m_io_04 of the main menu).

m_pw_user (m.38)

New password:
0000

The user password can be changed in this mask.

Alarm description masks

m_legenda (m.39)

Alarm legend
display enable: No

Enabling the alarm legend will make it possible to display the masks containing a description of the alarm code used in the alarm history. (See Alarm History masks on page)

The alarm description masks shown below will be displayed if enabled from the m_legenda mask.

al_def_01 (m.40)

AL01:
Condensing pressure
probe fault

al_def_02 (m.41)

AL02:
Indoor temperature
probe fault

al_def_03 (m.42)

AL03:
Supply air temp.
probe fault

al_def_04 (m.43)

AL04:
Outdoor temperature
probe fault

al_def_05 (m.44)

AL06:
High pressure by
pressostat

al_def_06 (m.45)

AL06:
High pressure by
pressostat

al_def_07 (m.46)

AL07:
Low pressure by
pressostat

al_def_08 (m.47)

AL08:
Air flow too low or
absent

al_def_09 (m.48)

AL09:
Dirty filter

al_def_10 (m.49)

AL10:
Compressor overload

al_def_11 (m.50)

AL11:
Electric heater
overload

al_def_12 (m.51)

AL12:
Phase sequence fault
or power fault

al_def_13 (m.52)

AL13:
High temperature in
the shelter (40°C)

al_def_14 (m.53)

AL14:
Max temperature in
the shelter (50°C)

al_def_15 (m.54)

AL15:
Min temperature in
the shelter

al_def_16 (m.55)

AL16:
Free-cool. anomaly
or electric heater

al_def_17 (m.56)

AL17:
Compressor
maintenance!

al_def_18 (m.57)

AL18:
Evaporator
maintenance!

al_def_19 (m.58)

AL19:
Evaporator fan speed
is lower than the
minimum level

al_def_20 (m.59)

AL20:
Minimum condensing
pressure

al_def_21 (m.60)

AL21:
pLAN in fault!
check the address
or the connection

6.3 Alarm menu

(Alarm button)

The red light of the Alarm button turns on to indicate that alarms have occurred in the system. When the Alarm button is pressed, all active alarms will be displayed. Pressing the key a second time will reset the alarms; if the causes of the alarms persist, they will again be signalled.

m_no_alarm (m.61)
NO ALARM DETECTED

This message is displayed when no alarms are active.

m_al_probe_01 (m.62)

AL01
PROBE B1 ALARM:
Condens. pressure

m_al_probe_03 (m.63)

AL02
PROBE B3 ALARM:
Indoor temperature

m_al_probe_04 (m.64)

AL03
PROBE B4 ALARM:
Supply air
temperature

m_al_probe_05 (m.65)

AL04
PROBE B5 ALARM:
Outdoor temperature

m_al_hp_sonda (m.66)

AL06
HIGH PRESSURE
ALARM

m_al_hp_ps (m.67)

AL06
HIGH PRESSURE
ALARM

m_al_lp_ps (m.68)

AL07
LOW PRESSURE
ALARM

m_al_flusso (m.69)

AL08
AIR FLOW
ALARM

m_al_filtri (m.70)

AL09
DIRTY FILTER
ALARM

m_al_comp (m.71)

AL10
COMPRESSOR
OVERLOAD

m_al_res (m.72)

AL11
ELECTRIC HEATER
OVERLOAD

m_al_senso_fasi (m.73)

AL12
PHASES SEQUENCE
ALARM OR
POWER FAULT

m_al_alta_temp (m.74)

AL13
HIGH TEMPERATURE
IN THE SHELTER

m_al_max_temp (m.75)

AL14
MAX TEMPERATURE
IN THE SHELTER

m_al_min_temp (m.76)

AL15
MINIMUM
TEMPERATURE ALARM

m_al_anom_fc (m.77)

AL16
FREE-COOL ANOMALY
OR ELECTRIC HEATER
FAILURE

m_al_fun_comp (m.78)

AL17
COMPRESSOR
MAINTENANCE

m_al_fun_evap (m.79)

AL18
EVAPORATOR
MAINTENANCE

m_al_speed_evap (m.80)

AL19
EVAP. FAN SPEED
TOO LOW

m_al_p_min_mand (m.81)

AL20
MINIMUM CONDENSING
PRESSURE

m_al_plan (m.82)

AL21
pLAN ALARM:
check the dip switch
and the addresses

6.4 Alarm history menu

(PRG+ALARM buttons)

Pressing the Prg+Alarm buttons together provides access to the alarm history menu. The progressive number, time, date and code of the last ten alarms occurring are stored according to a FIFO logic (first in – first out).

al_story_01 (m.83)

History alarm (1) 00:00 00/00/00 code: AL00

Mask for displaying the alarm history; this function may be enabled from the m_legenda mask.

6.5 Manufacturer menu

(ESC+PROG buttons)



The manufacturer menu is protected by a password, made available on request. Warning: changing the manufacturer parameter settings may undermine the proper functioning of the units.

pw_costr (m.84)

Manufacturer menu: Password: 0000

Access to the manufacturer menu is protected by a password that can be changed from the m_pw_costr mask.

m_costr (m.85)

Manufacturer menu: enabled ...

Entering the correct manufacturer password will enable the masks of the manufacturer menu.

m_config_01 (m.86)

Unit configuration: STAND ALONE UNIT
--

It allows to set the unit operating in LAN or stand-alone.

m_freecooling (m.87)

Freecooling enable: N

It allow to enable the freecooling.

m_probe_00 (m.88)

External temperature probe enable: N

It allows to enable the external temperature probe.

m_probe_01 (m.89)

Probe Offset
 B1: 00.0bar
 B3: 00.0C B4: 00.0C
 B5: 00.0C B2: 00.0 Q%

It allows offset values to be set for the temperature and pressure probes, for the purpose of calibrating the probes themselves.

m_probe_02 (m.90)

Pres. probe range:
 Lower level 00.0bar
 Higher level 00.0bar

The upper and lower limits of the operating range of pressure probe 1 are set in this mask.

m_probe_03 (m.91)

Fault probe alarm
 enable:
 No

Here it is possible to enable alarm management in case of a probe fault.

m_probe_04 (m.92)

Fault probe alarms
 enable:
 B1: No B3: No
 B4: No B5: No

If the probe fault alarm management function is enabled this mask will be displayed, which allows alarms to be enabled for individual probes.

m_probe_05 (m.93)

Fault probe alarms
 delay
 000 s

If the probe fault alarm management function is enabled this mask will be displayed; from here it is possible to set a delay in the triggering of the probe alarm.

m_din_01 (m.94)

Digital input filter
 enable: No
 Filtering time:
 000 s

In this mask it is possible to enable a digital filter and set the relative filtering time.

m_vent_evap_01 (m.95)

Evaporator fan speed
 regulation:
 0.0% - 100.0%
 000.0

In this mask it is possible to set the evaporator fan speed (in percentage terms).

m_vent_evap_02 (m.96)

Evaporator fan speed
 with free-cool. and
 compr. off:
 000.0

In this mask it is possible to set the evaporator fan speed in the free-cooling mode, when the compressor is off.

m_vent_cond_01 (m.97)

Condensing control
 Out 0 - 10 V
 Lower level 00.0 V
 Higher level 00.0 V

In this mask it is possible to set the lower and upper limits of the 0 – 10 V output for regulating the condensation fan speed.

m_vent_cond_02 (m.98)

Condensing control
Set 00.0 bar
Band 00.0 bar

outputs from the keyboard.
The pressure setpoint and differential band for condensation control are set in this mask.

m_serranda_01 (m.99)

Output reversal
0-10V in 10-0V? No
Min value: 000.0 %
Max value: 000.0 % Q%

In this mask it is possible to regulate the operation of the diverter by setting a maximum and minimum supply voltage (in percentage terms); the signal may also be inverted.

Masks for enabling the forcing of controller inputs and outputs

This function is useful for carrying out functional tests on the units.

m_tastiera_01 (m.100)

Temp. by keyboard
enable: No
Press. by keyboard
enable: No Q%

In this mask it is possible to enable a function for forcing the temperatures (internal, outdoor and outlet air) and pressures (condensation and evaporation) from the keyboard.

m_tastiera_02 (m.101)

Analog output
by keyboard enable:
No Q%
Q% Q%

In this mask it is possible to enable the forcing of digital inputs and

m_tastiera_03 (m.102)

Analog output
by keyboard enable:
Y1: No Y2: No
Y3: No Q%

In this mask it is possible to enable the forcing of each individual analog output from the keyboard:
Y1: condensation fan;
Y2: evaporation fan;
Y3: free-cooling diverter.

m_tastiera_04 (m.103)

Digital input by
keyboard No
Digital output by
keyboard No

In this mask it is possible to enable the forcing of analog outputs in general from the keyboard.

Masks for enabling and configuring alarms

Depending on the type of alarm, it will be necessary to program a setpoint (Set), differential band (Diff), alarm signal delay (Delay) and whether the alarm is to be automatically or manually reset (Aut o Man). It should be emphasized that in the case of automatic resetting, the unit will resume normal operation as soon as the cause of the alarm disappears; only the red light of the Alarm button will remain lit; in the case of manual resetting the unit will remain in an alarm status until the Alarm button is pressed twice.

Masks for managing the probe-activated high pressure alarm

al_hp_s_01 (m.104)

High pressure by
probe alarm enable:
No

Here it is possible to enable the probe-activated high pressure alarm, useful for preventing a high pressure alarm from being activated by the triggering of the pressure switch

al_hp_s_02 (m.105)

HP by probe alarm
Set : 00.0 bar
Diff. : 00.0 bar
Delay : 0000 s

Here the setpoint, differential and delay time are set.

al_hp_s_03 (m.106)

HP by probe alarm
Reset AUT/MAN: AUT

Here the resetting mode of the probe-activated high pressure alarm is set.

Masks for managing the pressure switch-activated high pressure alarm

al_hp_ps_01 (m.107)

High pressure by
pressostat alarm
enable: No

condenser fan, ambient, outlet and outdoor temperatures and hours of operation of the evaporator and condenser.

al_hp_ps_02 (m.108)

High pressure alarm
delay:000 s

The delay time is set here.

Here the pressure switch-activated high pressure alarm is enabled. This mask is displayed when the unit is switched on or when the Esc key is pressed. The data shown are: status of the compressor, evaporator fan,

al_hp_ps_03 (m.109)

High pressure alarm
Reset AUT/MAN: AUT

The resetting mode is set here.

Masks for managing the minimum pressure alarm

al_min_press_01 (m.110)

Minimum condensing
pressure alarm
enable: No

Here it is possible to enable the minimum outlet pressure alarm, useful for preventing a low pressure alarm from being activated by the triggering of the pressure switch.

al_min_press_02 (m.111)

Min cond. P alarm
Set : 00.0 bar
Diff. : 00.0 bar
Delay : 0000 s

Here the setpoint, differential and delay time are set.

al_min_press_03 (m.112)

Min cond. pressure
alarm
Reset AUT/MAN: AUT

The resetting mode is set here.

Masks for managing the pressure switch-activated low pressure alarm

al_lp_01 (m.113)

Low pressure by
pressostat alarm
enable: No

Here it is possible to enable the pressure switch-activated low pressure alarm.

al_lp_02 (m.114)

Low pressure alarm
delay
Starting: 0000 s
Running : 0000 s Q%

Here it is possible to set a delay in the triggering of the alarm when the unit is started (Starting) and during normal operation (Running).

al_lp_03 (m.115)

Low pressure alarm
Rip. aut./man.: AUT

The resetting mode is set here.

Masks for managing the insufficient air flow alarm

al_fluss_01 (m.116)

Air flow alarm
enable: No

Here it is possible to enable the air flow switch alarm, which may indicate a malfunctioning of the evaporator fan.

al_fluss_02 (m.117)

Air flow alarm
delay:0000 s

The delay time is set here.

al_fluss_03 (m.118)

Air flow alarm
Reset AUT/MAN: AUT

The resetting mode is set here.

al_fluss_04 (m.119)

Air flow alarm
disable on fan
startup No

From this mask it is possible to disable the air flow switch alarm during the fan startup phase.

al_fluss_05 (m.120)

Air flow alarm
disable on fan
startup delay: 000 s

Here it is possible to set the time for which the air flow alarm will remain disabled.

Masks for managing the dirty air filter alarm

al_fluss_06 (m.121)

Dirty filter alarm
enable: No

From here the dirty filter alarm is enabled. It is triggered by a flow switch that measures the difference between the filter inlet and outlet pressures.

al_fluss_07 (m.122)

Dirty filter alarm
delay:
0000 s

The delay time is set here.

al_fluss_08 (m.123)

Dirty filter alarm
Reset AUT/MAN: AUT

The resetting mode is set here.

Masks for managing the compressor thermal alarm

al_compr_01 (m.124)

Overload compressor
alarm enable:
No

From here the compressor thermal alarm is enabled. It is triggered by the thermal switch present in the compressor.

al_compr_02 (m.125)

Overload compressor
alarm:
Reset AUT/MAN: AUT

The resetting mode is set here.

al_compr_03 (m.126)

Overload compressor
alarm delay:
0000 s

The delay time is set here.

Masks for managing the heating element thermal alarm:

al_res_01 (m.127)

Electric heater
alarm enable:
No

From here the heating element thermal alarm is enabled. It is triggered by the thermal switch present in the heating element.

al_res_02 (m.128)

Electric heater
alarm:
Reset AUT/MAN: AUT

The resetting mode is set here.

al_res_03 (m.129)

Electric heater
alarm delay:
0000 s

The delay time is set here.

Masks for managing the phase direction or minimum voltage alarm

al_sf_tens_01 (m.130)

Phases sequence
fault or power fault
alarm enable:
No

From here it is possible to enable the phase direction or minimum voltage alarm, triggered when the three-phase power supply has not been properly connected or the mains power supply is cut off.

al_sf_tens_02 (m.131)

Phases sequence
fault alarm
Reset AUT/MAN: AUT

The resetting mode is set here.

al_sf_tens_03 (m.132)

Phases sequence
fault alarm delay:
0000 s

The delay time is set here.

Masks for managing additional alarms

en_al_temp (m.133)

Temperature alarm
only if evaporator
fan is ON:
No

In this mask it is possible to enable a function that will allow temperature alarms to be triggered only when the evaporator fan is on.

al_vel_ev_01 (m.134)

Evaporator fan
minimum speed alarm
enable: No

In this mask it is possible to enable the evaporator fan minimum speed alarm; the minimum speed is set in the al_vel_ev_02 mask.

al_vel_ev_02 (m.135)

Evaporator fan
Min. speed: 000.0 %

The minimum evaporator fan speed is set here.

al_vel_ev_03 (m.136)

Evaporator fan
minimum speed alarm
delay:
0000 s

The delay time is set here.

m_status_vc (m.137)

Compr. ON after min
supply air temp.
alarm differential:
Diff.: 00.0 C

In this mask it is possible to set differential for re-enabling the compressor after a stop triggered by an excessively low outlet air temperature.

m_an_funz (m.138)

Functional fault
alarm enable:
No

From here the functional fault signalling alarm is enabled.

m_an_funz_explo (m.139)

Separated alarm
enable:
No

Separated alarm enable. (See Section 4 Alarm management)

m_an_blocco (m.140)

Block fault alarm
enable:
No

From here the compressor disabling fault signalling alarm is enabled

al_plan_01 (m.141)

pLAN alarm enable:
No

From here it is possible to enable the pLAN alarm, triggered when the dipswitches on the circuit board have not been properly connected or when a problem occurs in the unit network connection.

al_plan_02 (m.142)

pLAN alarm delay:
000 s

The delay time is set here.

Several additional masks for configuring the microprocessor are illustrated below.

m_compressore (m.143)

Compressor time
T min ON : 0000 s
T min OFF: 0000 s
T min 2 ON: 0000 s

In this mask it is possible to set the compressor time parameters:
- the minimum time a compressor must remain on; - the minimum time a compressor must remain off; - the minimum time that must elapse between two start-ups of the same compressor.

m_cond_1 (m.144)

Anticipation on
condensing fan
startup enable: No

In this mask it is possible to enable the condensation fan to start a certain time before the compressor.

m_cond_02 (m.145)

Anticipation cond.
fan time: 0000 s
Condensing fan
speed: 000.0 %

In this mask it is possible to set how long in advance the condenser fan will start up and its speed (in percentage terms), if the function has been enabled from the m_cond_1 mask.

m_cond_03 (m.146)

Cond. fan speed with
pressure probe fault
(0-100) 000.0 %

In this mask it is possible to set the condensation fan speed (in percentage terms) for operation in the event of pressure probe fault alarm.

m_time_h (m.147)

Automatic restart
after power fault:
0000 s

In this mask it is possible to set the duration of the special unit management function, implemented following a power failure. (See section 4.4.1 Managing a power failure)

m_corsa_serr (m.148)

Damper running time:
000 s

In this mask it is possible to set the operating time of the modulating diverter. This parameter is used by the special management function following a power failure. (See section 4.4.1 Managing a power failure)

m_consenso_rem (m.149)

Remote contact
enable:
No

In this mask it is possible to enable the remote control input connected to the terminal block of the electric control board. It should be noted that this is a normally closed contact.

m_rot_unit (m.150)

Master/slave cycling
time:
00000 ore

In this mask it is possible to set the interval of time (in hours) after which the unit cut-in sequence is reset. It should be noted that the cut-in sequence is based on the shutdown of the last compressor, with precedence being given to the other compressor, unless it is already running. This mask is enabled if the unit has a pLAN address set as 1.

m_selezione (m.151)

Master/Slave by
keyboard enable: No
Slave

In this mask it is possible to enable the forcing of the master/slave operating mode from the keyboard. This mask is enabled if the unit has a pLAN address set as 1.

m_light_off_01 (m.152)

Light on display
built-in management:
No

In this mask it is possible to enable management of the backlighting of the controller built-in display. If the function is enabled, a switching off delay may be set from the m_light_off_02 mask. If the function is disabled the lighting will remain constantly on.

m_light_off_02 (m.153)

Light on display
built-in management
delay: 000 s

In this mask it is possible to set a switching off delay for the backlighting of the built-in display, if the function has been enabled from the m_light_off_02 mask.

m_buzzer (m.154)

Buzzer enable:
No

In this mask it is possible to enable the alarm buzzer. (With remote terminal only)

m_set_clock (m.155)

Clock setting
00:00 00/00/00

In this mask it is possible to set the current time and date.

m_superv_01 (m.156)

Protocol type:
- CAREL

In this mask it is possible to set the serial communication protocol used by the supervisor system. The Carel proprietary protocol and MODBUS Rtu protocol may be used.

m_superv_02 (m.157)

Supervisor config.
Baudrate: 1200
Serial address: 000

In this mask it is possible to set the serial transfer speed and the serial address of the unit.

m_defaults (m.158)

Reset all parameters
to default values

In this mask it is possible to reset the default parameters shown in the table on page ??

m_pw_costr (m.159)

Insert another
manufacturer
password: 0000

Enabling mask: m_tastiera_04
In this mask it is possible to change the manufacturer password providing access to the manufacturer menu.

MAIN MASKS ENABLED FROM THE MANUFACTURER MENU

The masks described in this paragraph are displayed in the main menu only if they have been enabled from the manufacturer menu, in the mask indicated in the description.

m_temp_01 (m.160)

Temp. by keyboard
Tint 00.0 C
Tsup 00.0 C
Text 00.0 C

In this mask it is possible to force the ambient, outdoor and outlet air temperature from the keyboard.

Enabling mask: m_tastiera_01

m_press_01 (m.161)

Pressure by keyboard
Cond. pressure
00.0bar

In this mask it is possible to force the condensation pressure from the keyboard.

Enabling mask: m_tastiera_01

m_anout_01 (m.162)

Output by keyboard
Evap. 000.0 0-100%
Cond. 000.0 0-100%
Damp. 000.0 0-100%

In this mask it is possible to force from the keyboard the analog outputs for controlling respectively the evaporation and condensation fans and the modulating diverter. Enabling masks: m_tastiera_02 and m_tastiera_03

m_digin_01 (m.163)

Din by keyboard (1)
HP: No LP: No
FL: No DF: No
PF: No Q%

In this mask it is possible to force from the keyboard the digital alarm inputs: high pressure (HP), low pressure (LP), air flow (FL), dirty filters (FS) and phase direction (SF).

m_digin_02 (m.164)

Din by keyboard (2)
 Comp. alarm: No
 Heater alarm: No
 Rem. contact: No Q%

In this mask it is possible to force from the keyboard the remaining digital inputs: compressor thermal alarm, heating element thermal alarm and remote control.

Enabling mask: m_tastiera_04

m_digout_01 (m.165)

Dout by keyboard (1)
 Compressor: No
 Condensator fan: No
 Electric heater: No Q%

In this mask it is possible to force from the keyboard the digital outputs for switching on respectively the compressor, condenser and heating element.

Enabling mask: m_tastiera_04

m_digout_02 (m.166)

Dout by keyboard (2)
 Funct. alarm: No
 Block alarm: No
 Free contact: No Q%

In this mask it is possible to force from the keyboard the functional alarm and compressor disabling alarm digital outputs and an additional available digital output.

m_digout_03 (m.167)

Dout by keyboard (3)
 other free output Q%
 5: OFF 6: OFF

In this mask it is possible to force from the keyboard another two available digital outputs.

Enabling mask: m_tastiera_04

7 ARCHITECTURE OF THE CONTROL SYSTEM

7.1 Layout of microprocessor with or without built-in display

Description of connectors

1. Connector to the power supply [G(+), G0(-)];
2. Yellow LED indicating power on and red alarm LED;
3. fuse 250 Vac, 2 A delayed (T2 A)
4. universal analog inputs NTC, 0-1 V, 0-10 V, 0-20 mA, 4-20 mA;
5. passive analog inputs NTC, PT1000, ON/OFF;
6. analog outputs 0-10 V;
7. digital inputs at 24 Vac/Vdc;
8. digital inputs at 230 Vac or 24 Vac/Vdc;
9. connector for synoptic terminal;
- 10.connector for standard terminal PCOT, PCOI pCO2 series and for downloading the application program;
11. digital outputs (relays);
- 12.connector for connection to the I/O expansion modules;
- 13.connector, addressing and LED for the local network (pLAN);
- 14.flap for installation of RS485 serial card (for connection to the serial supervisor line) or RS232 card (for modem interface);
- 15.flap for installation of card for connection to a parallel printer;
- 16.flap for installation of programming key or memory expansion module;
- 17.built-in terminal (LCD, buttons and LEDs).

Printer Card Serial Card Expansion Memory

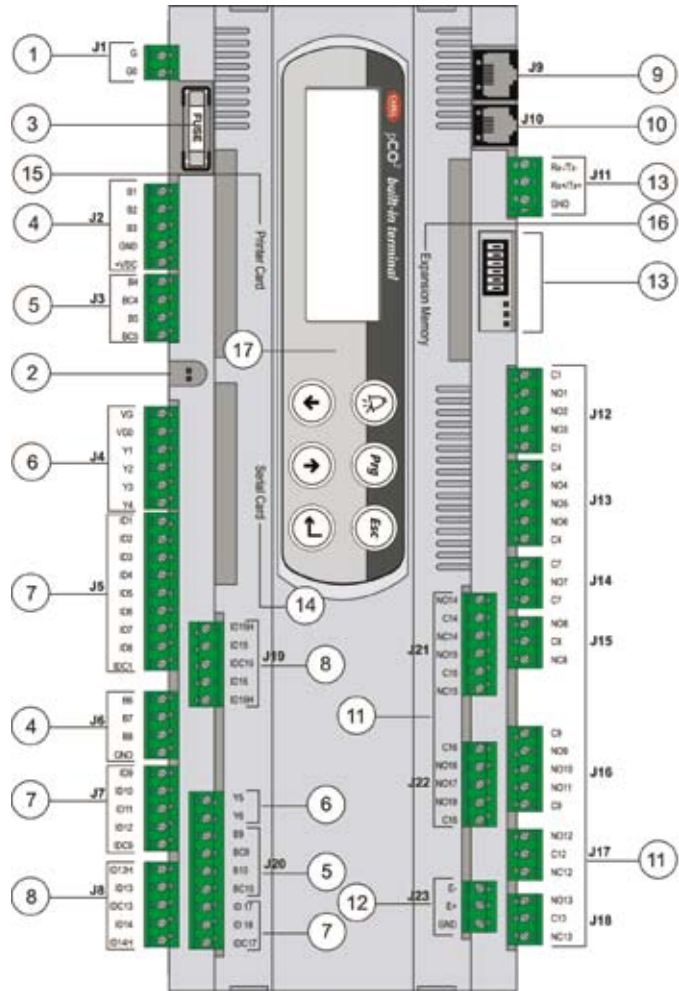

7.2 Description of inputs and outputs

Conn.	Label	Signal	Description
Analog input			
J2-1	B1	4-20 mA	Condensation pressure
J2-2	B2		
J2-3	B3	NTC	Air temperature inside the shelter
J3-1	B4	NTC	Outlet air temperature
J3-3	B5	NTC	Outdoor air temperature
Analog output			
J4-3	Y1	0..10 V	Evaporator fan rotation regulator
J4-4	Y2	0..10 V	Condenser fan rotation regulator
J4-5	Y3	0..10 V	Free-cooling diverter servomotor
J4-6	Y4		
Digital input			
J5-1	ID1	24 Vac/Vdc	High pressure alarm
J5-2	ID2	24 Vac/Vdc	Low pressure alarm
J5-3	ID3	24 Vac/Vdc	Air flow switch (evaporator fan alarm)
J5-4	ID4	24 Vac/Vdc	Air flow switch (dirty filter alarm)
J5-5	ID5	24 Vac/Vdc	No power / phase direction alarm
J5-6	ID6	24 Vac/Vdc	Master force
J5-7	ID7	24 Vac/Vdc	Heating element alarm (triggered by thermal switch)
J5-8	ID8	24 Vac/Vdc	Remote on/off
Digital output (Function separated alarms switched off)			
J12-2	NO1	NO relè	On-Off compressor
J12-3	NO2	NO relè	On-Off condensing fan
J12-4	NO3	NO relè	On-Off heating element
J13-2	NO4	NO relè	Functional alarm
J13-3	NO5	NO relè	
J13-4	NO6	NO relè	
J14-2	NO7	NO relè	Block fault alarm
J15-1	NO8	NO relè	
Digital output (Function separated alarms switched on)			
J12-2	NO1	NO relè	On-Off compressor
J12-3	NO2	NO relè	On-Off condensing fan
J12-4	NO3	NO relè	On-Off heating element
J13-2	NO4	NO relè	Air flow alarm
J13-3	NO5	NO relè	Free-cooling or heating element fault alarm
J13-4	NO6	NO relè	High or low temperature alarm
J14-2	NO7	NO relè	High or low pressure alarm
J15-1	NO8	NO relè	Dirty air filters alarm

7.3 Optional cards

7.3.1 Remote terminal

The microprocessor can be connected to a remote terminal via a telephone cable or AWG24 shielded cable.

Connection via telephone cable

The connection must be made as shown in *Figure 2* and two ferrites must be applied to eliminate disturbance. The maximum length of the connection is 50 m.

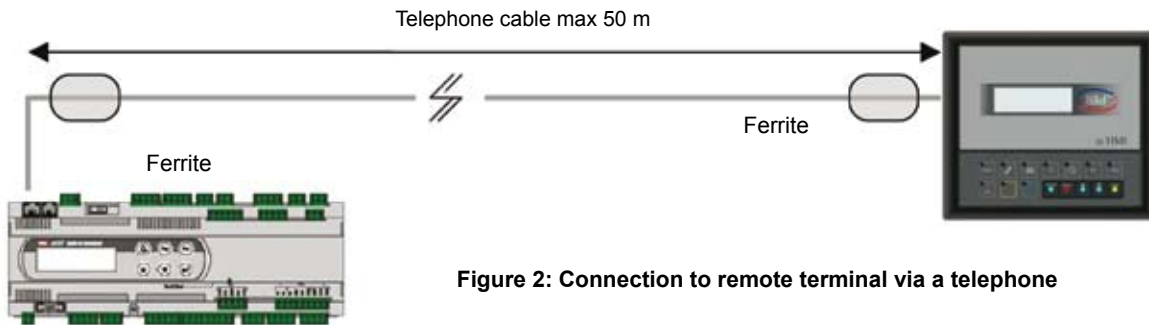

Figure 2: Connection to remote terminal via a telephone

Connection via AWG24 shielded cable

The cable must have 3 twisted pairs and shielding and the connection must be made as shown in *Figure 2*; two signal switch must be used and the maximum length of the connection is 200 m.

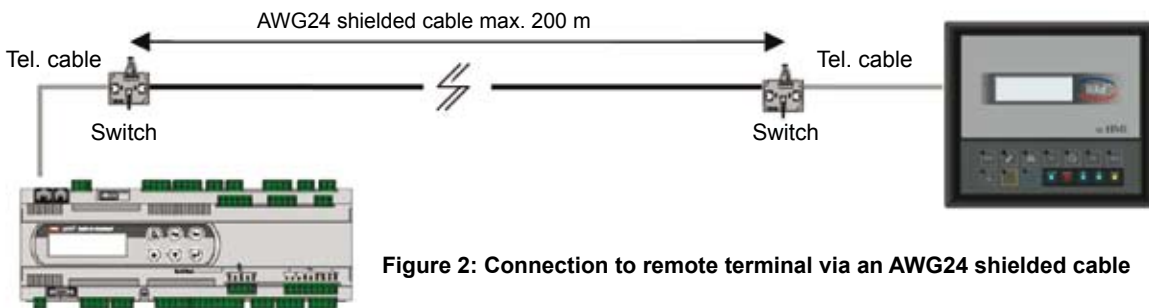

Figure 2: Connection to remote terminal via an AWG24 shielded cable

7.3.2 RS485 serial card for supervisor system

To make a serial connection with a local or remote supervisor system it is necessary to install an RS485 serial card, available on request (see *Figure 2*).

A description of remote management configurations is provided in section 5.2 Supervision

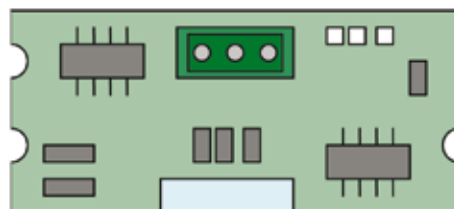

Figure 2: RS485 serial card

8 APPLICATION SETTING PARAMETERS

8.1 Table of default values for two indoor units

8.1.1 User menu

Mask		Function	Description	U.M.	Default
Name	NO.				
m_fc_01	m.13	Set	Setpoint for enabling free-cooling function	°C	3.0
		Diff	Differential for enabling free-cooling function	°C	2.0
m_fc_02	m.14	Set	Setpoint for enabl. slave unit free-cooling function	°C	22.0
		Dif	Differential for enabl. slave unit free-cooling function	°C	2.0
m_res_01	m.15	Set 1	Master heating element activation setpoint	°C	5.0
		Diff 1	Master heating element activation differential	°C	4.0
m_res_02	m.16	Set 2	Slave heating element activation setpoint	°C	3.0
		Diff 2	Slave heating element activation differential	°C	4.0
m_raft_01	m.17	Set 1	Master unit compressor activation setpoint	°C	27.0
		Diff 1	Master unit compressor activation differential	°C	4.0
m_raft_02	m.18	Set 2	Slave unit compressor activation setpoint	°C	30.0
		Diff 2	Slave unit compressor activation differential	°C	4.0
m_imm_01	m.19	Set	Setpoint for diverter modulation of outlet temperature	°C	10.
		Diff	Differential for diverter modulation of outlet temperature	°C	4.0
al_alta_temp_01	m.20	Enabling	Enable high temp. alarm	-	YES
al_alta_temp_02	m.21	Set	High temperature alarm activation setpoint	°C	40.0
		Diff	High temperature alarm activation differential	°C	5.0
al_alta_temp_03	m.22	Delay	Delay in activation of high temperature alarm	s	0
al_max_temp_01	m.23	Enabling	Enable max temp. alarm	-	YES
al_max_temp_02	m.24	Set	Max temp. alarm activation setpoint	°C;	50.0
		Diff	Max temp. alarm activation differential	°C	5.0
al_max_temp_03	m.25	Delay	Delay in activation of max temperature alarm	s	0
al_min_temp_01	m.26	Enabling	Enable min temp. alarm	-	YES
al_min_temp_02	m.27	Set	Min temp. alarm activation setpoint	°C	3.0
		Diff	Min temp. alarm activation differential	°C	4.0
al_min_temp_03	m.28	Delay	Delay in activation of min temperature alarm	s	0
al_anom_fc_01	m.29	Enabling	Enable F.C. fault alarm	-	YES
al_anom_fc_02	m.30	Set	Setpoint for activating F.C. fault alarm in relation to ambient temperature	°C	12.0
		Diff	Differential for activating F.C. fault alarm in relation to ambient temperature	°C	0
al_anom_fc_03	m.31	Set	Setpoint for activating F.C. fault alarm in relation to outlet air and ambient temperature	°C	2.0
		Diff	Differential for activating F.C. fault alarm in relation to outlet air and ambient temperature	°C	0.0
al_anom_fc_04	m.32	Delay	Delay in activation of F.C. fault alarm	s	0
m_ore_comp_01	m.33	Enabling	Enable compressor operating threshold exceeded alarm	-	YES
m_ore_comp_02	m.34	Threshold	Operating threshold for compressor maintenance	h	5000
M_ore_evap_01	m.35	Enabling	Enable evaporator fan operating threshold exceeded alarm	-	YES

M_ore_evap_02	m.36	Threshold	Operating threshold for evaporator fan maintenance (hours)	h	5000
m_debug_01	m.37	Enabling	Enable debug masks	-	NO
m_legenda	m.39	Enabling	Display of alarm legend	-	YES

8.1.2 Manufacturer menu

Mask Name	NO.	Parameter	Description	U.M.	Default
m_config_01	m.86	Configuration	Unit configuration	-	LAN
m_freecooling	m.87	Enabling	Enable freecooling	-	SI
m_probe_00	m.88	Enabling	Enable the external temp. probe	-	SI
m_probe_01	m.89	B1	Offset for probe calibration	bars	0.0
		B3	"	°C	0.0
		B4	"	°C	0.0
		B5	"	°C	0.0
m_probe_02	m.90	Lower limit	Pressure probe lower limit	bars	0.0
		Upper limit	Pressure probe upper limit	bars	30.0
m_probe_03	m.91	Enabling	Enable probe fault alarm mgmt.	-	YES
m_probe_04	m.92	B1	Enable probe alarm	-	YES
		B3	"	-	YES
		B4	"	-	YES
		B5	"	-	YES
m_probe_05	m.93	Delay	Delay in probe fault alarm	s	10
m_din_01	m.94	Enabling	Enable digital input filter	-	NO
		Time	Filtering time	s	5
m_vent_evap_01	m.95	Speed	Evaporator fan speed	%	100
m_vent_evap_02	m.96	Speed	Evaporator fan speed w/ free-cooling and compressor off	%	100
m_vent_cond_01	m.97	Lower limit	Lower limit of 0-10V output regulating condenser fan speed	V	0
		Upper limit	Upper limit of 0-10V output regulating condenser fan speed	V	3.5
m_vent_cond_02	m.98	Set	Condensation control setpoint	bars	11
		Band	Condensation control band	bars	10
m_serranda_01	m.99	Inversion	Inversion of 0-10V output to 10-0V for diverter regulation	-	YES
		Min. val.	Minimum diverter regulation value	%	90
		Max. val.	Maximum diverter regulation value	%	0
m_tastiera_01	m.100	Enabl. temp.	Enable temperature from keyboard	-	NO
		Enabl. press.	Enable pressure from keyboard	-	NO
m_tastiera_02	m.101	Enabl. analog outputs	Enable analog outputs from keyboard	-	NO
m_tastiera_03	m.102	Y1	Enable analog output Y1 from keyboard	-	NO
		Y2	Enable analog output Y2 from keyboard	-	NO
		Y3	Enable analog output Y3 from keyboard	-	NO
m_tastiera_04	m.103	Din from keyb.	Enable digital inputs from keyboard	-	NO
		Dout from keyb.	Enable digital outputs from keyboard	-	NO
al_hp_s_01	m.104	Enabling	Enable probe-activated high pressure alarm	-	NO
al_hp_s_02	m.105	Set	Probe-activ. high pressure alarm setpoint	bars	28.0
		Diff.	Probe-activ. high press. alarm differential	bars	2.0
		Delay	Delay in probe-activ. high press. alarm	s	0

Mask					
Name	NO.	Parameter	Description	U.M.	Default
al_hp_s_03	m. 106	Resetting	Probe-activ. high press. alarm resetting		
al_hp_ps_01	m.107	Enabling	Enable pressure switch-activated high pressure alarm	- -	MAN YES
al_hp_ps_02	m. 108	Delay	Delay in pressure switch-activated high pressure alarm	-	0
al_hp_ps_03	m. 109	Resetting	Pressure switch-activated high pressure alarm resetting	-	MAN
al_min_press_01	m.110	Enabling	Enable minimum outlet pressure alarm		
al_min_press_02	m. 111	Set	Minimum outlet pressure alarm setpoint	-	NO
		Diff.	Minimum outlet pressure alarm differential	bars	-
		Delay	Delay in probe-activ. min. pressure alarm	bars	-
al_min_press_03	m. 112	Resetting	Probe-activ. min. pressure alarm resetting	s	-
al_lp_01	m.113	Enabling	Enable pressure switch-activated low pressure alarm	- -	- YES
al_lp_02	m. 114	Starting	Delay in pressure switch-activated low pressure alarm at start-up	s	120
		Running	Delay in pressure switch-activated low pressure alarm during normal operation	s	0
al_lp_03	m. 115	Resetting	Probe-activated low pressure alarm resetting	-	MAN
al_fluss_01	m.116	Enabling	Enable air flow alarm		
al_fluss_02	m. 117	Delay	Delay in air flow alarm	-	YES
al_fluss_03	m. 118	Resetting	Air flow alarm resetting	s	30
al_fluss_04	m. 119	Disabling	Disable air flow alarm at start-up of evaporator fan	- -	MAN YES
al_fluss_05	m. 120	Delay	Delay in air flow alarm		
al_fluss_06	m. 121	Enabling	Enable dirty filters alarm	s	20
al_fluss_07	m. 122	Delay	Delay in dirty filters alarm	-	YES
al_fluss_08	m. 123	Resetting	Dirty filters alarm resetting	s	30
al_compr_01	m.124	Enabling	Enable compressor thermal alarm	-	MAN
al_compr_02	m. 125	Resetting	Compressor thermal alarm resetting	-	YES
al_compr_03	m. 126	Delay	Delay in compressor thermal alarm	-	MAN
al_res_01	m.127	Enabling	Enable heating element alarm (thermal switch)	s -	0 YES
al_res_02	m. 128	Resetting	Heating element alarm resetting (thermal switch)	-	MAN
al_res_03	m. 129	Delay	Delay in heating element alarm (thermal switch)	s	0
al_sf_tens_01	m.130	Enabling	Enable phase direction or minimum voltage alarm	-	YES
al_sf_tens_02	m. 131	Resetting	Phase direction or minimum voltage alarm resetting	-	AUT
al_sf_tens_03	m. 132	Delay	Delay in phase direction or minimum voltage alarm	s	0
en_al_temp	m.133	Enabling	Enable temperature alarm only if evaporator fan is on	-	YES
al_vel_ev_01	m.134	Enabling	Enable minimum evaporator fan speed alarm	-	YES
al_vel_ev_02	m. 135	Min. speed	Minimum evaporator fan speed		
al_vel_ev_03	m. 136	Delay	Delay in minimum evaporator fan speed alarm	% -	40 0
m_status_vc	m.137	Differential	Differential for re-enabling of compressor after a stop due to low outlet temp.	°C	4.0

Mask					
Name	NO.	Parameter	Description	U.M.	Default
m_an_funz	m.138	Enabling	Enable functional alarm	-	YES
m_an_blocco	m.140	Enabling	Enable compressor disabling alarm	-	YES
al_plan_01	m.141	Enabling	Enable pLan alarm	-	YES
al_plan_02	m. 142	Delay	Delay in pLan alarm	s	60
m_compressore	m.143	T min ON	Minimum time a compressor must remain on	s	10
		T Min OFF	Minimum time a compressor must remain off	s	360
		T min 2 starts	Minimum time interval between two start-ups of the same compressor	s	360
m_cond_01	m.144	Enabling	Enable condensation fan to start before compressor	-	YES
m_cond_02	m. 145	Advance	Amount of time in advance the condensation fan will start up	s	10
		Speed	Cond. fan speed during advance operat.	%	100
m_cond_03	m. 146	Speed	Cond. fan speed with pressure probe fault alarm	%	100
m_time_h	m.147	Duration	Duration of special mgmt. function after power failure	s	60
m_corsa_serr	m.148	Time	Operating time of free-cooling diverter	s	20
m_consenso_rem	m.149	Enabling	Enable remote control input	-	YES
m_rot_unit	m.150	Reset time	Unit cut-in sequence reset time	hours	24
m_selezione	m.151	Enabling	Enable master/slave from keyboard	-	NO
		Master/Slave	Master/slave selection from keyboard	-	Master
m_light_off_01	m.152	Enabling	Enable display backlighting management	-	YES
m_light_off_02	m. 153	Delay	Delay in switching off of display backlighting	s	30
m_buzzer	m.154	Enabling	Enable alarm buzzer	-	YES
m_set_clock	m.155	Time	Time setting	-	-
		Date	Date setting	-	-
m_superv_01	m.156	Protocol type	Serial communication protocol	-	CAREL
m_superv_02	m.157	Transm. Speed	Transmission speed	-	19200
		Serial address	Unit serial address	-	1

9 TECHNICAL DATA

General specifications

operating conditions	10T60 oC (0T50 oC versions with built-in terminals)
protection rating	%UR 90 not condensing
heat and fire resistance class	IP20, IP40 on front panel only
immunity against overvoltages	class D (UL94 - V0)
number of manoeuvring cycles of automatic operations (e.g.: relay)	class 1 100 000
Class and structure of software	Class A

Electrical specifications

power supply (controller with connected terminal)	22 to 40 Vdc and 24 Vac $\pm 15\%$ 50/60 Hz. Maximum power consumption: 20 W
terminal block	with extractable male/female connectors maximum voltage: 250 Vac; cable size (2mm): min 0.5 to max 2.5
CPU	H83002 16 bits 14 MHz
program memory (on FLASH MEMORY)	16 bit organisation: 1 MByte (expandable to 6 MByte)
data memory (static RAM)	16 bit organisation: 256 kByte (expandable to 1 MByte)
parameter data memory	16 bit organisation 2 kByte
operating cycle delay pCO ₂ with applications of medium complexity	(upper limit: 400,000 write per memory location) 0.5 s

Analog inputs

number	5
analog conversion	A/D converter 10 bit CPU built-in
type	NTC, PT1000, 0-1 V, 0-10 V, 0-20 mA
NTC input precision	± 0.5 °C
PT1000 input precision	± 1 °C
0-1 V input precision	± 3 mV
0-10 V input precision	± 30 mV
0-20 mA input precision	± 0.06 mA

Digital inputs

number	8
type	optoinsulated inputs at 24 Vac 50/60 Hz

Analog outputs

number	4
type	optoinsulated 0-10 Vdc
power supply	external power supply 24 Vac/Vdc
0-10V output precision	± 200 mV
Y1-Y4 output resolution	20 mV
Y5-Y6 output resolution	80 mV
max load current	10 mA (corresponding to a minimum impedance of 1 kW)

Digital outputs

number	8
type	with electromechanical relays



www.lennox europe.com

BELGIUM, LUXEMBOURG
www.lennoxbelgium.com

CZECH REPUBLIC
www.lennoxczech.com

FRANCE
www.lennoxfrance.com

GERMANY
www.lennoxdeutschland.com

NETHERLANDS
www.lennoxnederland.com

POLAND
www.lennoxpolska.com

PORTUGAL
www.lennoxportugal.com

RUSSIA
www.lennoxrussia.com

SLOVAKIA
www.lennoxdistribution.com

SPAIN
www.lennoxspain.com

UKRAINE
www.lennoxukraine.com

UNITED KINGDOM AND IRELAND
www.lennoxuk.com

OTHER COUNTRIES
www.lennoxdistribution.com

Due to Lennox's ongoing commitment to quality, the Specifications, Ratings and Dimensions are subject to change without notice and without incurring liability.

Improper installation, adjustment, alteration, service or maintenance can cause property damage or personal injury.

Installation and service must be performed by a qualified installer and servicing agency.

