

# User manual



## CLIMATIC™ 60 Aircooled chillers





**TABLE OF CONTENTS**

1. INTRODUCTION .....	2
2. OVERVIEW .....	2
3. SCHEDULING ZONE .....	3
4. SCHEDULING MODE .....	4
5. SCHEDULING ZONE ANTICIPATION .....	5
6. CHANGEOVER HEAT / COOL .....	6
7. FREE INPUT / OUTPUT .....	8
8. WATER EVAPORATOR .....	12
9. PUMP EVAPORATOR MANAGMENT .....	16
10. PUMP EVAPORATOR FLOW CONTROL .....	17
11. PUMP CONDENSER MANAGMENT .....	19
12. PUMP CONDENSER FLOW CONTROL .....	20
13. COMPRESSOR .....	23
14. CONDENSER FAN .....	25
15. FAN SMART ACCOUSTIC SYSTEM™ .....	27
16. COIL DEFROST .....	30
17. WATER CONDENSER .....	31
18. FREECOOLING .....	32
19. ELECTRICAL HEATER .....	33
20. POWER FACTOR CORRECTOR .....	34
21. MASTER / SLAVE .....	35
22. DISPLAY DC60 .....	36
23. DISPLAY DS60 .....	38
24. BMS .....	42
25. INPUTS / OUTPUTS CLIMATIC BOARDS .....	44
26. SETTING LIST .....	46
27. ALARMS .....	69

## 1 - INTRODUCTION

### 1.1 - CONTROLLER CLIMATIC™ 60

The new generation of microprocessor based control, CLIMATIC™ 60 may be fitted to the Lennox Chiller or Heat pump range. It inherits 20 years of technology and field operating experience from its predecessors the CLIMATIC™1 and CLIMATIC™2 and CLIMATIC™50.

LENNOX has found the latest hardware technology available on the market place and developed software specifically designed for Chiller and Heat pump applications, maximising the LENNOX unit's efficiency and performance.

### 1.2 - COMPATIBILITY

This documentation is compatible with the programs Chiller and Heat pump:

- ECOLEAN range from software version CH060 STD - Vers. 01.0 - Rev 00.0,
- NEOSYS standards range (STD) from software version CH060 STD - Vers. 01.0 - Rev 00.0.

### 1.3 - WARNING

Any parameter modification should be carried out by trained and licensed competent technician. Before start-up or restart of a unit controlled by the CLIMATIC™ 60, it is mandatory to check adequacy between CLIMATIC™ 60 and the unit with its options. In case of wrong parameters, the inputs / outputs connections could be incorrect and may create some operation problems for the units and ultimately breakdowns. Lennox cannot be held responsible for any claims on the units due to a wrong parameters sequence or a parameters modification carried out by non competent technicians. In this case, the warranty will be legally null and void.

## 2 - OVERVIEW

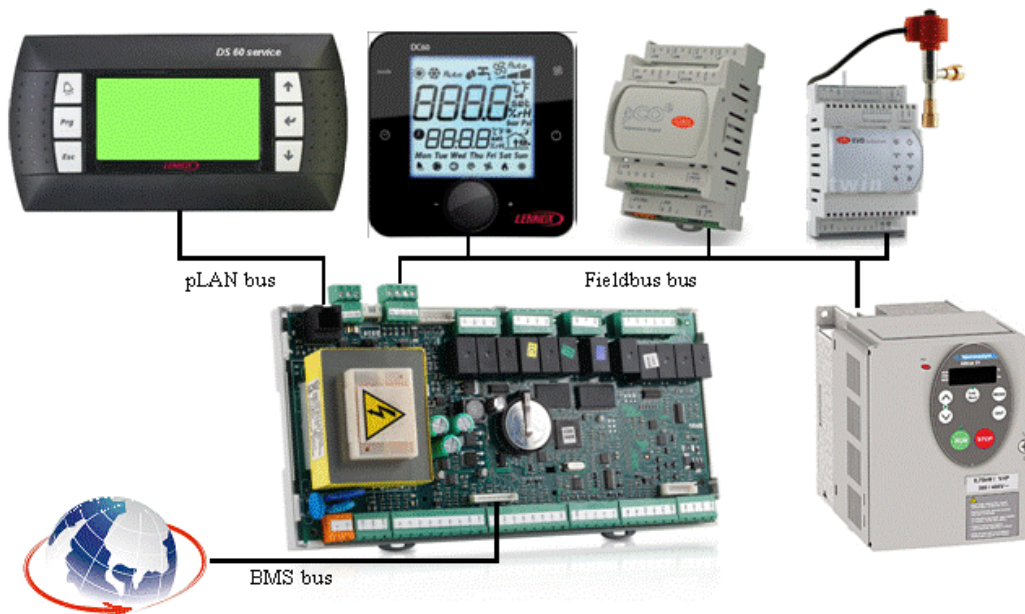

### **3 - SCHEDULING ZONE**

#### **3.1 - Function**

The CLIMATIC™ 60 is provided by a real time clock which offers solutions to specify a weekly schedule.

#### **3.2 - Description**

The CLIMATIC™ 60 schedule manages up to 7 distinct clock zones per day from 00h00 to 24h00 and from Monday to Sunday. The zone can start at different time for each day of the week in order to optimise the operating of the unit.

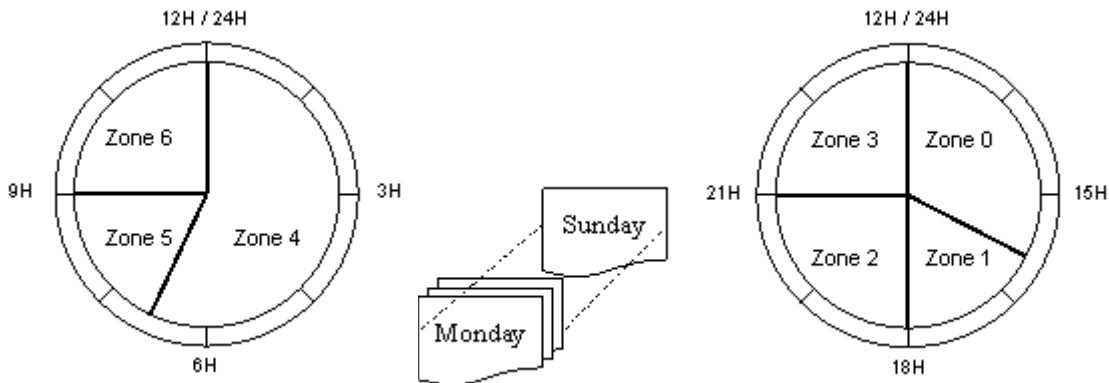

#### **3.3 - Settings**

The different settings to adjust the scheduling zone are available in the menu:

- (2141): Start time of the zone 0 from Monday to Sunday.
- (2142): Start time of the zone 1 from Monday to Sunday.
- (2143): Start time of the zone 2 from Monday to Sunday.
- (2144): Start time of the zone 3 from Monday to Sunday.
- (2145): Start time of the zone 4 from Monday to Sunday.
- (2145): Start time of the zone 5 from Monday to Sunday.
- (2146): Start time of the zone 6 from Monday to Sunday.

Note: The start time can take different values from Monday to Sunday. The start time of the zone 0 must be set to 00h00.

## 4 - SCHEDULING MODE

### 4.1 - Function

The CLIMATIC™ 60 is able to control different mode for each zone in order to optimise the operating of the unit.

### 4.2 - Description

The CLIMATIC™ 60 can manage up to 4 different modes.

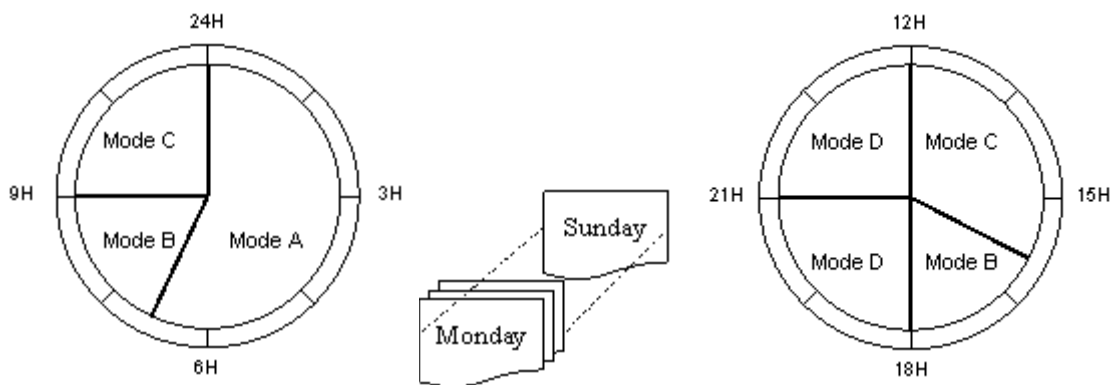

### 4.3 - Settings

The different settings to adjust the scheduling mode are available in the menu:

- (2151): Mode used during the period of the zone 0 from Monday to Sunday.
- (2152): Mode used during the period of the zone 1 from Monday to Sunday.
- (2153): Mode used during the period of the zone 2 from Monday to Sunday.
- (2154): Mode used during the period of the zone 3 from Monday to Sunday.
- (2155): Mode used during the period of the zone 4 from Monday to Sunday.
- (2156): Mode used during the period of the zone 5 from Monday to Sunday.
- (2157): Mode used during the period of the zone 6 from Monday to Sunday.

Note: The mode used can take different values from Monday to Sunday.

## 5 - SCHEDULING ZONE ANTICIPATION

### 5.1 - Function

The CLIMATIC™ 60 allows the start up of the unit before the pre-specified hour of the first zone (Zone 1) of the day.

### 5.2 - Description

This function is able to start the unit in zone 1 earlier if the outdoor temperature is under a specified threshold. The typical application is to start the unit in heating mode if the weather is too cold compared to the actual season.

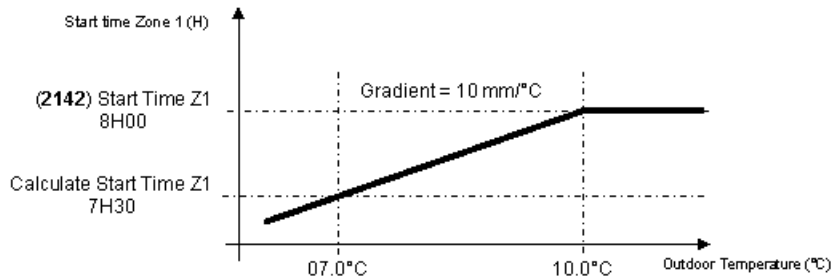

Example :

- (2142): Start time zone 1 : 8h00,
- (2161): Anticipation foot : 10.0°C,
- (2162): Anticipation gradient: 10mm/°C.

In this example the foot is set to the value 10.0°C, which means the zone 1 will always start at 8h00 if the outside air temperature is higher than 10.0°C. If the outside air temperature is less than 10.0°C the zone 1 will start according to the gradient selected and the difference from the foot value and the actual outside air temperature ( $10.0 - 7.0 = 3.0 \times 10 = 30\text{min}$ ). So the new start time for the zone 1 is 7h30.

### 5.3 - Settings

The different settings to adjust the anticipation are available in the menu:

- (2161): Anticipation foot.
- (2162): Anticipation gradient.

## 6 - CHANGEOVER HEAT / COOL

### 6.1 - Function

The CLIMATIC™ 60 control the changeover mode (for reversible units only) to specify the appropriate demand on heat water or chilled water production.

### 6.2 - Description

The changeover can also be pre-specify according to the scheduling and can take different mode for each schedule mode (A, B, C, D, and BMS).

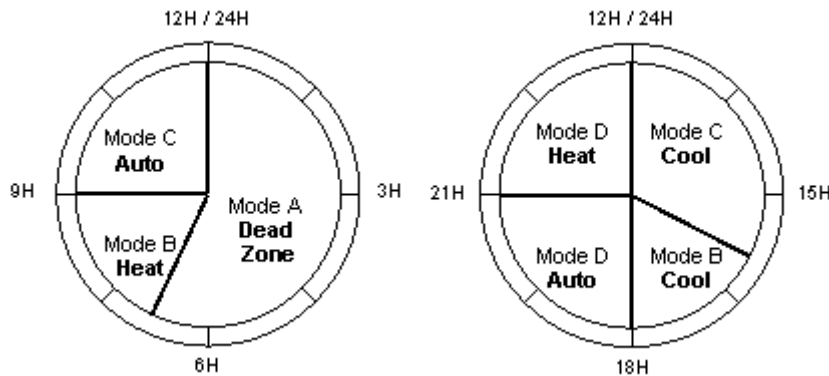

The changeover mode can be set by different solutions:

Automatically:

The CLIMATIC™ 60 determines the appropriate production of the water according to the outside temperature and move automatically the unit from the cooling to heating mode and heating to cooling mode.

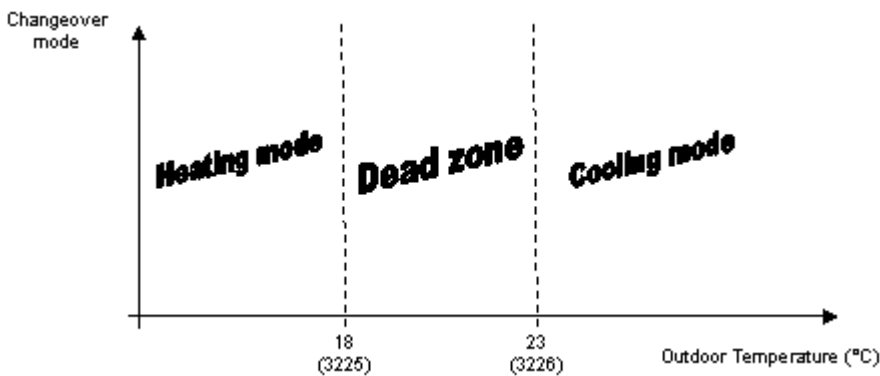

If the outside temperature is below the setting value (3225), the unit will operate as a heat pump.  
 If the outside temperature is over the setting value (3226), the unit will operate as a chiller.

Manually:

The changeover mode is pre-specifyd for each schedule mode. The various modes available are “Cool” mode, “Heat” mode or “Dead zone”. In this case the outside temperature has not effect on the changeover mode.

Remotely:

The changeover mode is set according to a remote dry contact connect on a free custom digital input. In this case the unit swaps in cooling or heating mode according to the status of the digital input. Please refer to the paragraph “Free Input / Output” for more details.



Terminal DC60:

The changeover mode (cool / heat) can be modified by the terminal DC60 by pressing the “mode” button.



When the “Auto” mode is selected, the icon “Cool” or “Heat” is displayed to signal the actual operating mode. Due to the communication delay, after pressing the “mode” button it is well advised to wait few seconds, the time to refresh of the icon on the display.

**6.3 - Settings**

The different settings to adjust the changeover mode are available in the menu:

- **(3224)**: Changeover mode (Cool, Heat, Auto, Dead zone) for each schedule mode (A, B, C, D, and BMS).
- **(3225)**: Minimum of outside temperature to swap to heating mode. If **(3224)**=“Auto”.
- **(3226)**: Maximum of outside temperature to swap to cooling mode. If **(3224)**=“Auto”.

## 7 - FREE INPUT / OUTPUT

### 7.1 - Function

The CLIMATIC™ 60 have free input / output on the main board BM60 and the expansion board BE60 to offer some possibilities to customize input / output for remote control of the unit.

### 7.2 - Description

The number of the free customized input / output is:

- 2 free contact input (normally opened) on BM60,
- 1 free contact output (normally opened) on BM60,
- 4 free contact input (normally opened) on BE60,
- 4 free contact (normally opened) output on BE60,
- 4 free analog input on BE60.

The expansion board BE60 is an additional board fixed on DIN rail. The description of the various connectors is:

- 1) Power supply of the board,
- 2) Analog output 0/10V : Not used,
- 3) Network bus to the CLIMATIC™ 60 BM60,
- 4) 4 Digital inputs : Only dry contacts,
- 5) Status LED of the network bus,
- 6) Serial address dip-switch of the network bus,
- 7) 4 Analog inputs configurable by pair B1-B2 and B3-B4,
- 8) 4 Digital outputs: Only dry contacts.

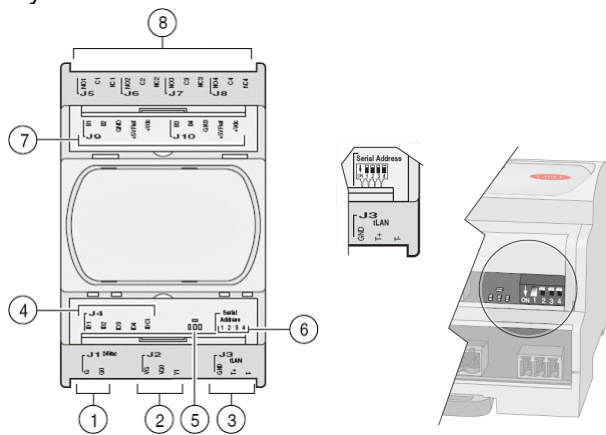

### **Power supply**

The expansion board BE60 is power in 24Vac, +/-15%, 50-60Hz,  $P_{max}=6W$ .

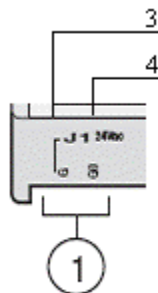

**Analog input**

The 4 analog inputs can be used as NTC probe (-50T90 °C; R/T 10 KΩ at 25 °C) or 4/20mA (Impedance = 100Ω) current signal. They are configurable by pair B1-B2 and B3-B4. The configuration of the type of the input is automatically set by the CLIMATIC™ 60.

The analog input can be configurable to be used as one of these items:

- 0) Not set,
- 1) Water set point desired,
- 2) Offset set point desired,
- 3) Free NTC probe.

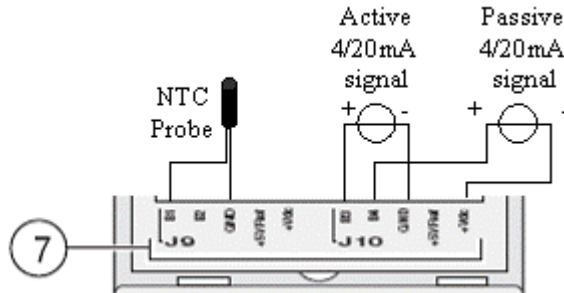

**Digital input**

The 4 digital inputs must be used with dry contacts according to the following example. The digital input can be configurable to be used as one of these items:

- 0) Not set,
- 1) Remote On/Off,
- 2) Remote reset alarm,
- 3) Swap to second water set point,
- 4) Force the cooling mode,
- 5) Force the heating mode,
- 6) Force the dead zone mode,
- 7) Force the defrost delay (10min),
- 8) Disable the circuit 1 (All compressors),
- 8) Disable the circuit 2 (All compressors),
- 9) Disable the circuit 1-compressor 1,
- 10) Disable the circuit 1-compressor 2,
- 11) Disable the circuit 1-compressor 3,
- 12) Disable the circuit 2-compressor 1,
- 13) Disable the circuit 2-compressor 2,
- 14) Disable the circuit 2-compressor 3,
- 15) Force the mode A,
- 16) Force the mode B,
- 17) Force the mode C,
- 18) Force the mode D,
- 19) Force the mode BMS,
- 20) Status of electrical heaters,
- 21) Free digital input.

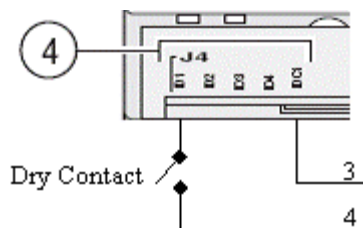

### Digital output

The 4 digital outputs are dry contacts and the maximum commutable power is 2000VA, 250Vac.

The digital output can be configurable to be used as one of these items:

- 0) Not set,
- 1) General alarm (alarm minor),
- 2) General fault (alarm major),
- 3) General alarm on circuit 1,
- 4) General alarm on circuit 2,
- 5) General alarm on condenser,
- 6) General alarm on evaporator pump(s),
- 7) Flow evaporator alarm,
- 8) Unit enable,
- 9) Unit available (ready to start),
- 10) Unit running (one compressor ON),
- 11) Unit running 100% (all compressor(s) ON),
- 12) Unit operating in cooling mode,
- 13) Unit operating in heating mode,
- 14) Unit operating in dead zone mode,
- 15) Unit operating in zone 0
- 16) Unit operating in zone 1,
- 17) Unit operating in zone 2,
- 18) Unit operating in zone 3,
- 19) Unit operating in zone 4,
- 20) Unit operating in zone 5,
- 21) Unit operating in zone 6,
- 22) Unit operating in mode A,
- 23) Unit operating in mode B,
- 24) Unit operating in mode B,
- 25) Unit operating in mode D,
- 26) Unit operating in mode BMS,
- 27) Output for additional electrical heater 1,
- 28) Output for additional electrical heater 2,
- 29) Output for additional electrical heater 3,
- 30) Output for additional electrical heater 4,
- 31) Free digital output.

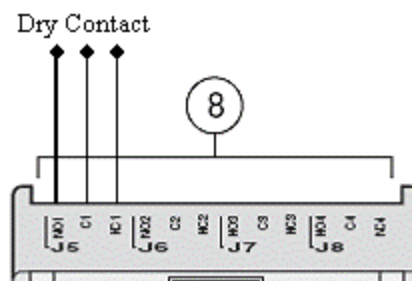

### **7.3 - Settings**

The different settings to configure the custom I/O are available in the menu:

- **(3131)**: Setting for the digital output on the connector BM60-J14-NO7,
- **(3132)**: Setting for the digital output on the connector BE60-J5-NO1,
- **(3133)**: Setting for the digital output on the connector BE60-J6-NO2,
- **(3134)**: Setting for the digital output on the connector BE60-J7-NO3,
- **(3135)**: Setting for the digital output on the connector BE60-J8-NO4.
- 
- **(3141)**: Setting for the digital input on the connector BM60-J4-ID4,
- **(3142)**: Setting for the digital input on the connector BM60-J4-ID7,
- **(3143)**: Setting for the digital input on the connector BE60-J4-ID1,
- **(3144)**: Setting for the digital input on the connector BE60-J4-ID2,
- **(3145)**: Setting for the digital input on the connector BE60-J4-ID3,
- **(3146)**: Setting for the digital input on the connector BE60-J4-ID4.
- 
- **(3151)**: Setting for the analog input on the connector BE60-J9-B1,
- **(3152)**: Setting for the analog input on the connector BE60-J9-B2,
- **(3153)**: Setting for the analog input on the connector BE60-J10-B3,
- **(3154)**: Setting for the analog input on the connector BE60-J10-B4.

## 8 - WATER EVAPORATOR

### 8.1 - Function

The CLIMATIC™ 60 controls the chilled or heat temperature according to the specified set point. The desired set point can be set by different solutions:

### 8.2 - Description

The CLIMATIC™ 60 offers various possibilities to specify the water evaporator set point.

#### 8.2.1 - Dynamic value

The CLIMATIC™ 60 determines the appropriate water set point according to the outside temperature in order to optimise the energy consumption. This method requires pre-defining 2 different water set points corresponding to 2 outside temperatures.

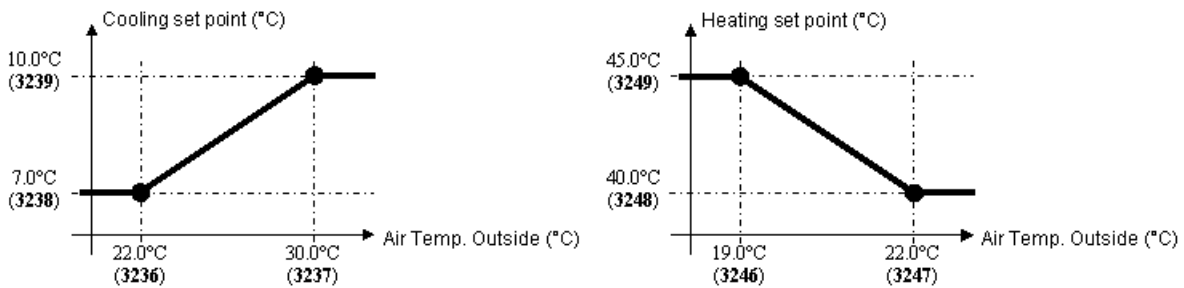

#### 8.2.2 - Fix value

In this case the outside temperature has no effect on the water set point and the set point (3238) and (3239) must be set at the same value.

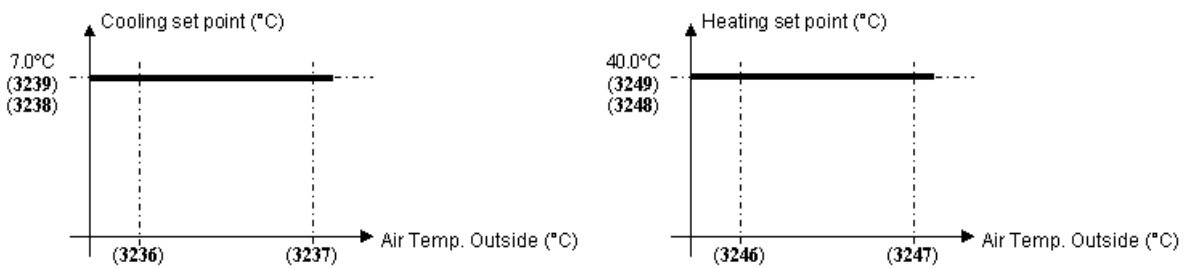

#### 8.2.3 - External current 4/20mA signal

In this case the actual set point is calculated according to the analog input current. The set point (3238) and (3239) specify the corresponding set point for 4mA and for 20mA.

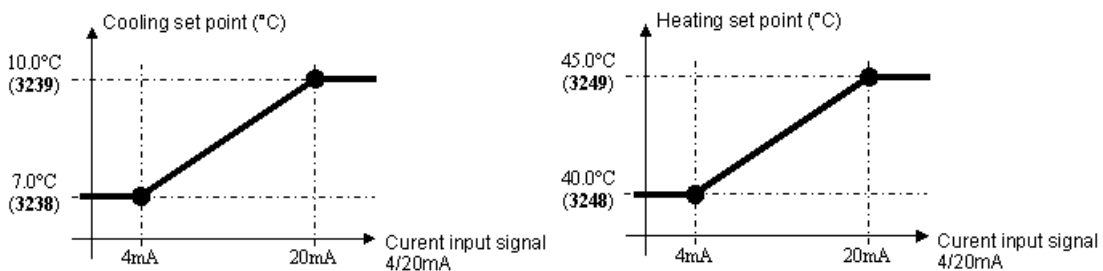

**8.2.4 - External second set point**

In this case the actual set point is specified by one of the 2 set point (3238) and (3239). The final set point depends on the status of the digital dry contact allocated to this function.

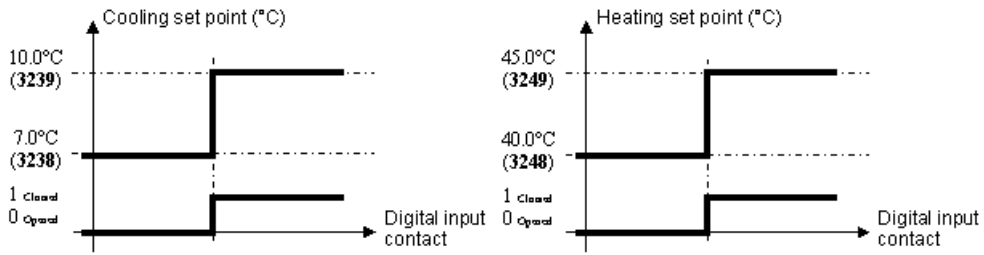

**8.2.5 - External current 4/20mA offset**

In this case the set point is set by one of the previous solution and can be adjust with an offset of +/- 1.0°C.

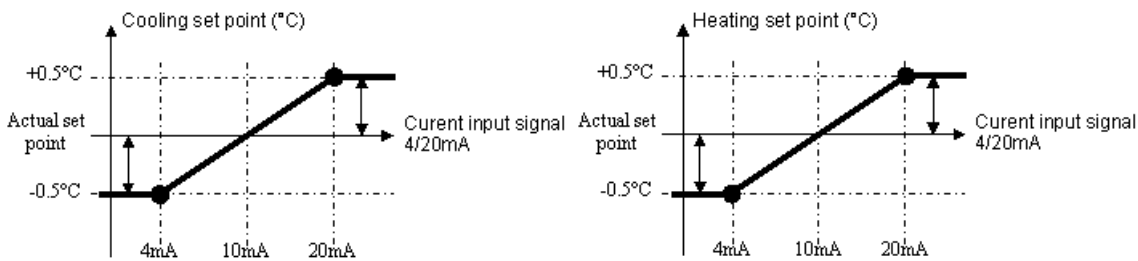

**8.2.6 - C60 value**

The CLIMATIC™ 60 receives the water set point from the DC60. If the set point read is different from the one calculated by the CLIMATIC™ 60, the new set point is set by the DC60 during the actual zone. Each time the zone is changing, the DC60 set point is overwritten by the CLIMATIC™ 60 set point.

**8.2.7 - BMS value**

The CLIMATIC™ 60 receives the water set point from the BMS. Refers to the “BMS” paragraph for more details.

The cooling and heating set points can be pre-specified according to the scheduling and can take different mode for each schedule mode (A, B, C, D, and BMS).

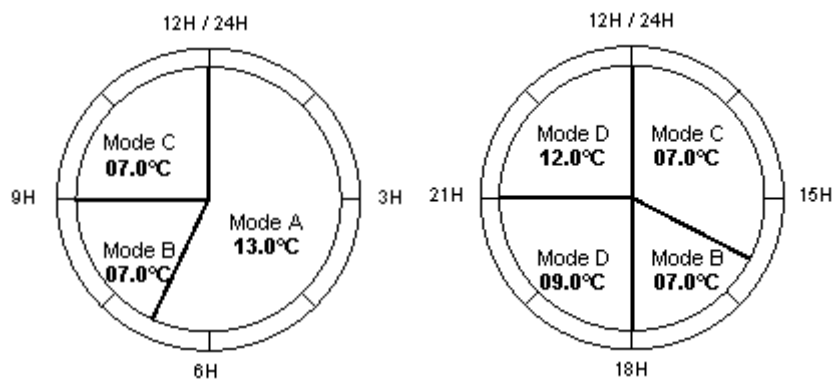

### **8.3 - Settings**

The different settings to adjust the water evaporator set points are available in the menu:

#### **8.3.1 - COOLING MODE**

- **(3236):** Minimum of outside air temperature corresponding to the water evaporator set point **(3238)** (used only for dynamic set point),
- **(3237):** Maximum of outside air temperature corresponding to the water evaporator set point **(3239)** (used only for dynamic set point),
- **(3238):**
  - Dynamic set point:  
Water evaporator temperature set point desired corresponding to outside air temperature **(3236)**,
  - Fix set point:  
Water evaporator temperature set point desired.
  - External current 4/20mA signal:  
Water evaporator temperature set point corresponding to a current signal of 4mA.
  - External second set point:  
First water evaporator temperature set point corresponding to a dry contact opened.
- **(3239):**
  - Dynamic set point:  
Water evaporator temperature set point desired corresponding to outside air temperature **(3237)**,
  - Fix set point:  
Water evaporator temperature set point desired.
  - External current 4/20mA signal:  
Water evaporator temperature set point corresponding to a current signal of 20mA.
  - External second set point:  
Second water evaporator temperature set point corresponding to a dry contact closed.

#### **8.3.2 6 HEATING MODE**

- **(3246):** Minimum of outside air temperature corresponding to the water evaporator set point **(3248)** (used only for dynamic set point),
- **(3247):** Maximum of outside air temperature corresponding to the water evaporator set point **(3249)** (used only for dynamic set point),
- **(3248):**
  - Dynamic set point:  
Water evaporator temperature set point desired corresponding to outside air temperature **(3246)**,
  - Fix set point:  
Water evaporator temperature set point desired.
  - External current 4/20mA signal:  
Water evaporator temperature set point corresponding to a current signal of 4mA.
  - External first set point:  
First water evaporator temperature set point corresponding to a dry contact opened.
- **(3249):**
  - Dynamic set point:  
Water evaporator temperature set point desired corresponding to outside air temperature **(3247)**,
  - Fix set point:  
Water evaporator temperature set point desired.
  - External current 4/20mA signal:  
Water evaporator temperature set point corresponding to a current signal of 20mA.
  - External second set point:  
Second water evaporator temperature set point corresponding to a dry contact closed.



**8.4 6 Control**

The Climatic™60 adjusts and hold the fluid outlet temperature as close as possible to the set point, by controlling the number of compressor stages depending on the thermal load of the system. The controller calculates constantly the required capacity to reach the temperature set point. This variable is called “CAPACITY FACTOR” (CF) and its value can vary from 0 to 100%. It is directly linked to the number of control stages of the unit. Thus for a unit with 4 stages of regulation, the CF will start and stop a stage with the following values: ~0-25-50-75-100%. It then evolves following the principles detailed in the diagram.

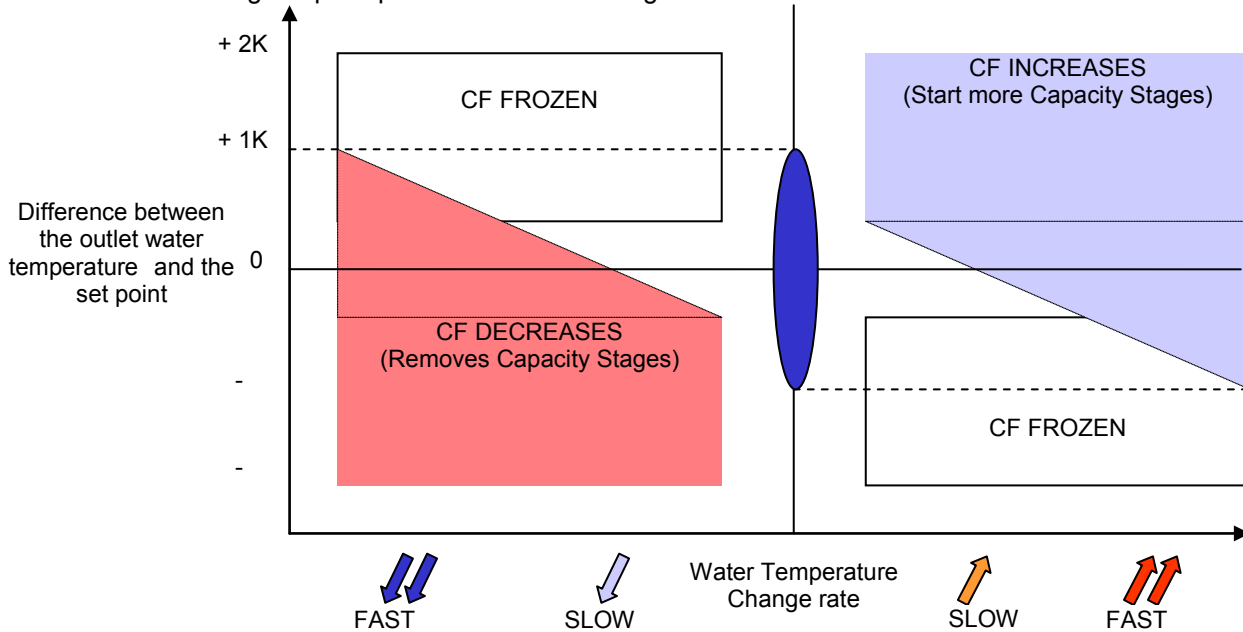

In order to anticipate, the reference point is recalculated each time the difference between air temperature and set point reach a minimum or a maximum.

Moreover the inlet temperature is used to limit the capacity factor to prevent from too slow reactivity of outlet capacity factor of the unit.

Example:

- Unit EAC 2104: cooling capacity: 210KW with:
  - C1.Cp1 = 19.2%,
  - C1.Cp2 = 30.8%,
  - C2.Cp1 = 19.2%,
  - C2.Cp2 = 30.8%.
- Maximum delta T° (inlet - outlet) at full load: setting (3261) = 5.0°C.
- Outlet water evaporator temperature set point: setting (3238) = (3239) = 7.0°C.

Stage	Minimum Inlet temp. (°C)	Maximum capacity factor (%)	Expression	Compressor ON circuit 1	Compressor ON circuit 2
0	0	0	0	1 2	1 2
1	8.54	30.8	$7.0 + 30.8 \cdot 5.0 / 100$	1 2	1 2
2	10.80	61.6	$7.0 + 2 \cdot 30.8 \cdot 5.0 / 100$	1 2	1 2
3	11.04	80.8	$7.0 + (19.2 + 2 \cdot 30.8) \cdot 5.0 / 100$	1 2	1 2
4	12.00	100.0	$7.0 + 2 \cdot (19.2 + 30.8) \cdot 5.0 / 100$	1 2	1 2

## **9 - PUMP EVAPORATOR MANAGEMENT**

### **9.1 - Function**

The CLIMATIC™ 60 offers in option a solution to manage a single or double evaporator pump(s).

### **9.2 - Description**

In case of double pumps the CLIMATIC™ 60 can manage various possibilities of operating of the pumps.

#### **9.2.1 - Priority to the pump 1**

The CLIMATIC™ 60 specifies the priority to the pump 1 to start first. The pump 2 is used only as backup pump and will start only if the pump 1 is in alarm. The pump 1 is kept ON as soon as the machine is enabled.

#### **9.2.2. - Priority auto to the pump 1**

Same configuration as the case 1, except that the pump will be stopped in case of dead zone changeover (winter / summer).

#### **9.2.3 - Priority to the pump 2**

The CLIMATIC™ 60 specifies the priority to the pump 2 to start first. The pump 1 is used only as backup pump and will start only if the pump 2 is in alarm. The pump 2 is kept ON as soon as the machine is enabled.

#### **9.2.4 - Priority auto to the pump 2**

Same configuration as the case 3, except that the pump will be stopped in case of dead zone changeover (winter / summer).

#### **9.2.5 - No Priority**

The CLIMATIC™ 60 specifies automatically the priority of the pump according the operating hour counter. The first pump to start will be the one which has the less number of hours of operation. In order to equalize the number of hours the unit is stopped every Tuesday at 02h00 am to re-specify the priority.

#### **9.2.6 - No Priority auto**

Same configuration as the case 5, except that the pump will be stopped in case of dead zone changeover (winter / summer).

### **9.3 - Settings**

The different settings to adjust the pump mode are available in the menu:

- **(3371)**: Type of rotation of the pump(s),

## 10 - PUMP EVAPORATOR FLOW CONTROL

### 10.1 - Function

The Climatic™60 offers the possibility to have a flow control in option.

### 10.2 - Description

There is up to 4 modes to manage the evaporator water flow.

#### 10.2.1 - Fix speed

The CLIMATIC™ 60 maintains a fix flow according to the maximum speed desired. The flow is set to the minimum flow desired only when none compressor is running.

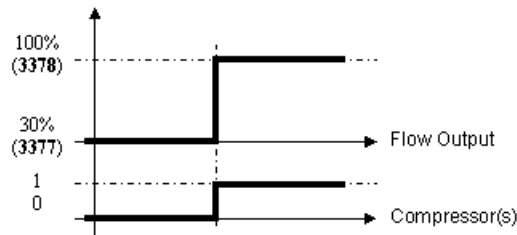

#### 10.2.2 - Fix delta T°

The CLIMATIC™ 60 maintains a fix delta of temperature according to the inlet and outlet temperature probe on the evaporator. The delta of temperature desired is customized in the menu (3374).

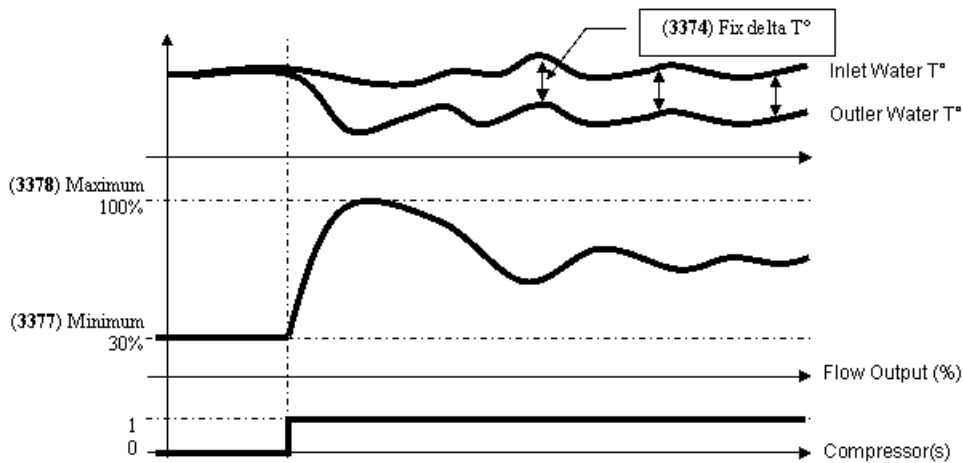

**10.2.3 - Fix delta P**

The CLIMATIC™ 60 maintains a fix delta of pressure according to the transducers (in and out) on the pump. The delta of pressure desired is customized in the menu (3375).

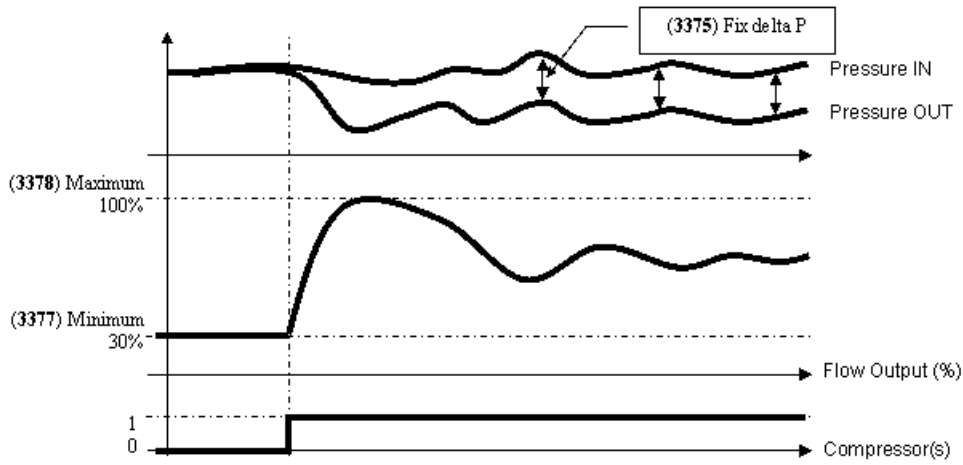

**10.2.4 - Fix Out P**

The CLIMATIC™ 60 maintains a fix out pressure according to the out transducer on the pump. The output pressure desired is customized in the menu (3376).

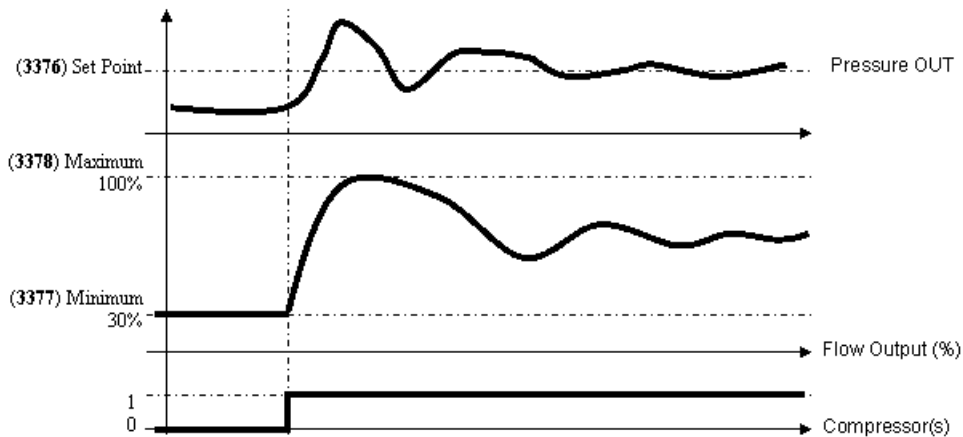

**10.3 - Settings**

The different settings to adjust the flow control are available in the menu:

- (3372): Type of flow control,
- (3374): Delta of temperature desired on the evaporator water (Outlet - Inlet),
- (3375): Delta of pressure desired on the water pump (Out - In),
- (3376): Output pressure desired on the water pump (Out),
- (3377): Minimum of flow on the evaporator water,
- (3378): Maximum of flow on the evaporator water.

## **11 - PUMP CONDENSER MANAGMENT**

### **11.1 - Function**

The CLIMATIC™ 60 offers in option a solution to manage a single or double condenser pump(s).

### **11.2 - Description**

In case of double pumps the CLIMATIC™ 60 can manage various possibilities of operating of the pumps.

#### **11.2.1 - Priority to the pump 1**

The CLIMATIC™ 60 specifies the priority to the pump 1 to start first. The pump 2 is used only as backup pump and will start only if the pump 1 is in alarm. The pump 1 starts when the unit is enabled and will never be stopped.

#### **11.2.2 - Priority auto to the pump 1**

Same configuration as the case 1, except that the pump will be stopped in case of dead zone changeover (winter / summer).

#### **11.2.3 - Priority to the pump 2**

The CLIMATIC™ 60 specifies the priority to the pump 2 to start first. The pump 1 is used only as backup pump and will start only if the pump 2 is in alarm. The pump 2 starts when the unit is enabled and will never be stopped.

#### **11.2.4 - Priority auto to the pump 2**

Same configuration as the case 3, except that the pump will be stopped in case of dead zone changeover (winter / summer).

#### **11.2.5 - No Priority**

The CLIMATIC™ 60 specifies automatically the priority of the pump according the operating hour counter. The first pump to start will be the one which has the less number of hours of operation. In order to equalize the number of hours the unit is stopped every Tuesday at 02h00 am to re-specify the priority.

#### **11.2.6 - No Priority auto**

Same configuration as the case 5, except that the pump will be stopped in case of dead zone changeover (winter / summer).

### **11.3 - Settings**

The different settings to adjust the pump mode are available in the menu:

- **(3381)**: Type of rotation of the pump(s),

## 12 - PUMP CONDENSER FLOW CONTROL

### 12.1 - Function

The CLIMATIC™ 60 offers the possibility to have a flow control in option.

### 12.2 - Description

#### 12.2.1 - Fix flow

The CLIMATIC™ 60 maintains a fix flow according to the maximum flow desired. The flow is set to the minimum flow desired only when none compressor is running.

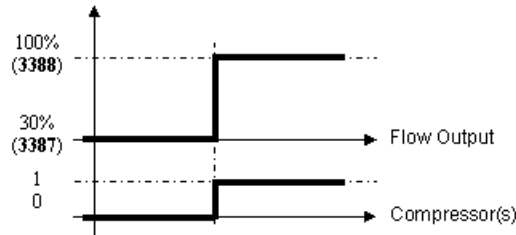

#### 12.2.2 - Fix delta T°

The CLIMATIC™ 60 maintains a fix delta of temperature according to the inlet and outlet temperature probe on the condenser. The delta of temperature desired is customized in the menu (3384).

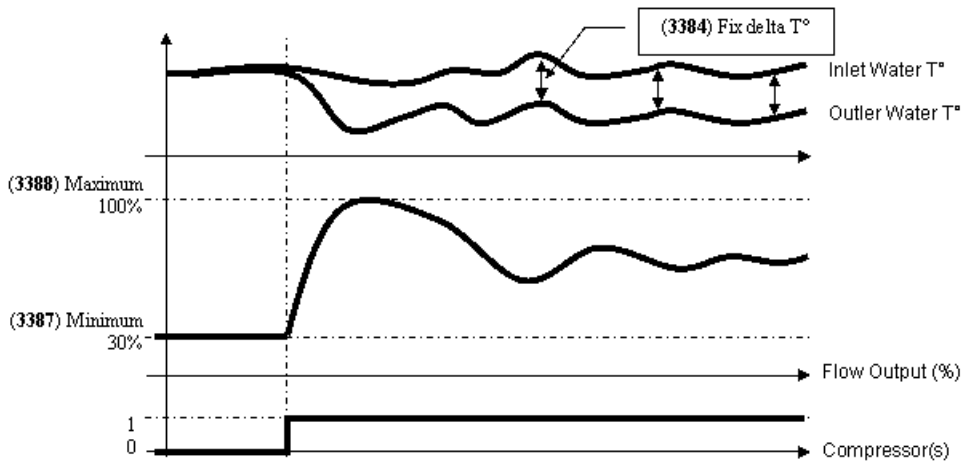

**12.2.3 - Fix delta P**

The CLIMATIC™ 60 maintains a fix delta of pressure according to the transducers (in and out) on the pump. The delta of pressure desired is customized in the menu (3385).

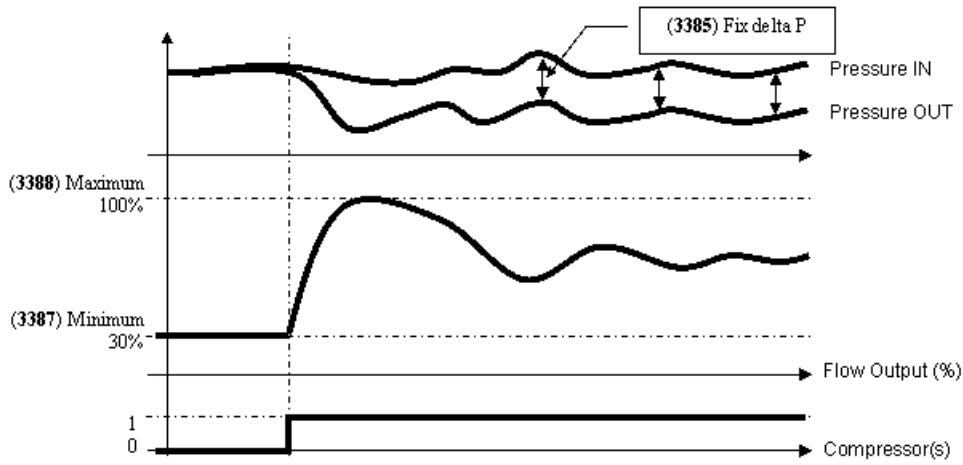

**12.2.4 - Fix Out P**

The CLIMATIC™ 60 maintains a fix out pressure according to the out transducer on the pmup. The output pressure desired is customized in the menu (3386).

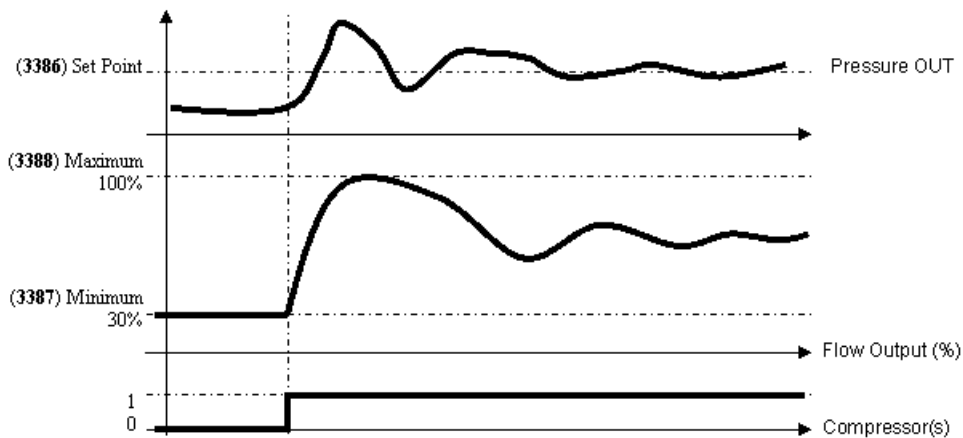

**12.2.5 - Fix condensing temperature**

The CLIMATIC™ 60 maintains a fix condensing temperature according to the outlet probe on the condenser. The condensing set point is customized in the menu (3546).

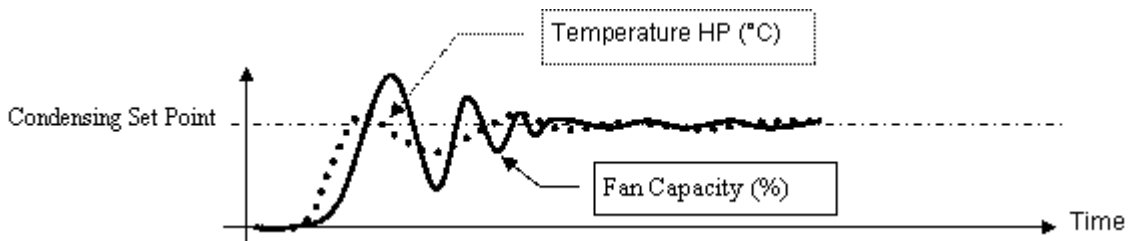

### **12.3 - Settings**

The different settings to adjust the flow control are available in the menu:

- **(3382)**: Type of flow control,
- **(3384)**: Delta of temperature desired on the evaporator water (Outlet - Inlet),
- **(3385)**: Delta of pressure desired on the water pump (Out - In),
- **(3386)**: Output pressure desired on the water pump (Out),
- **(3387)**: Minimum of flow on the condenser water,
- **(3388)**: Maximum of flow on the condenser water.



### 13 - COMPRESSOR

#### 13.1 - Function

The CLIMATIC™ 60 manages the compressor(s) according to the outlet temperature demand and engages the number of compressor calculated to reach the water set point.

#### 13.2 - Description

The CLIMATIC™ 60 offers possibilities to disable some compressor(s) on the circuit. Note this opportunity can be also done by dry contact (Refer to the “Free input/output” paragraph).

Item	Compressor on circuit (case of 3 compressors)
0	1 2 3
1	1 2 3
2	1 2 3
3	1 2 3
4	1 2 3
5	1 2 3
6	1 2 3
7	1 2 3

The compressors allowed to run can be pre-specifyd according to the scheduling and can take different values for each schedule mode (A, B, C, D, and BMS).

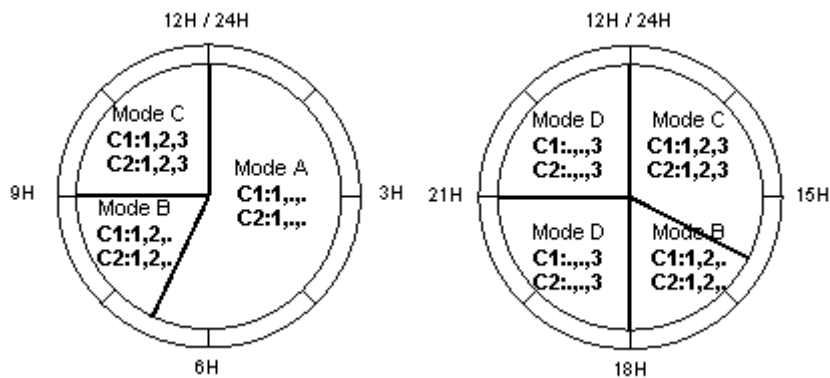

Moreover, the priority to circuit can be specified (for units with 2 circuits)

“Auto”:

This is the CLIMATIC™ 60 which decide the priority of the circuit to start first. Note that the priority is swapped when all the compressors are stopped in order to optimise the operating hours of the two circuits.

“Priority C1”:

The priority is fixed to the circuit 1, which means this is the circuit 1 which starts first and stops the last.

“Priority C2”:

The priority is fixed to the circuit 2, which means this is the circuit 2 which starts first and stops the last.

The compressor is subject to various operating time in order to prevent from damage operating.

- The minimum ON time of the compressor is fixed to 1 minute,
- The minimum OFF time of the compressor is fixed to 1 minute,
- The minimum between 2 starts of the same compressor is fixed to 5 minutes.

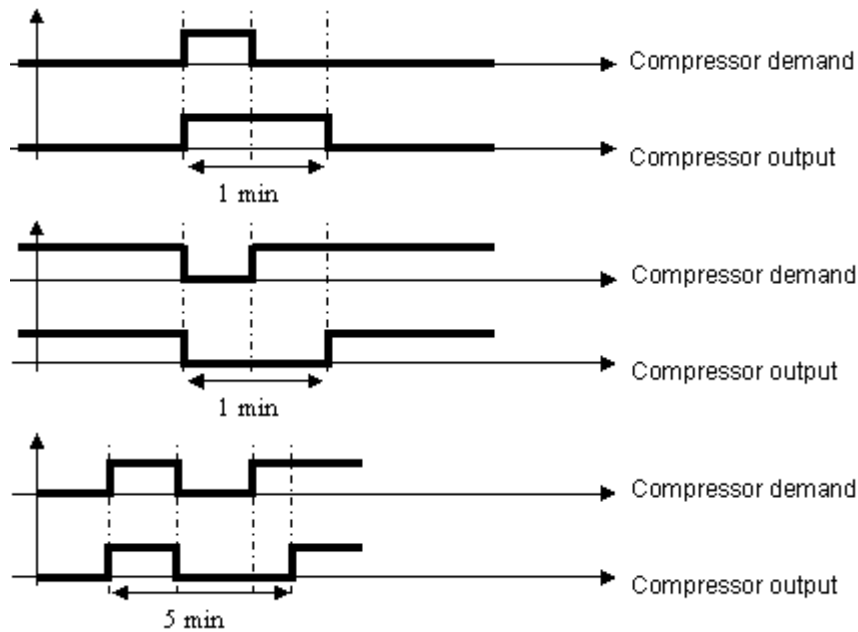

### **13.3 - Settings**

The different settings to configure the compressors are available in the menu:

- **(3331)**: Enable of the compressor(s) on the circuit 1
- **(3332)**: Enable of the compressor(s) on the circuit 2
- **(3335)**: Priority of the circuit rotation.

## 14 - CONDENSER FAN

### 14.1 - Function

The CLIMATIC™ 60 is used to maintain the high pressure as stable as possible in order to increase the performance of the unit.

### 14.2 - Description

The CLIMATIC™ 60 has 2 different fan managements according to the type of unit:

#### 14.2.1 - Ecolean unit (without fan speed inverter)

The CLIMATIC™ 60 manages 2 speeds on the fan (low and high speed).

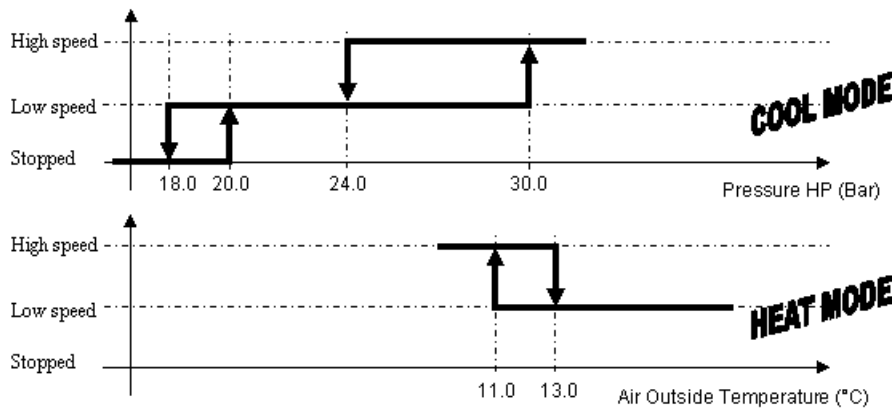

#### 14.2.2 - Neosys unit (standard version)

The condensing temperature is reached according to the set point selected in the menu (3546). The fans are managed by stages.

/\*\*\*\*\*/  
 UNDER CONSTRUCTION  
 /\*\*\*\*\*/

#### 14.2.3 - Neosys unit (premium version)

The condensing temperature is reached according to the outside air temperature and tries to maintain a delta of 12°C. Note that in this case the setting in the menu (3546) has no effect except if the value selected is different from the factory value. In this case the condensing set point is the value selected in the menu (3546).

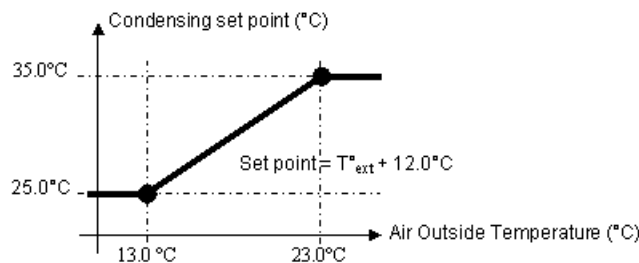

A fan inverter controlled by a PID algorithm is used to adjust the speed variation of the fans.

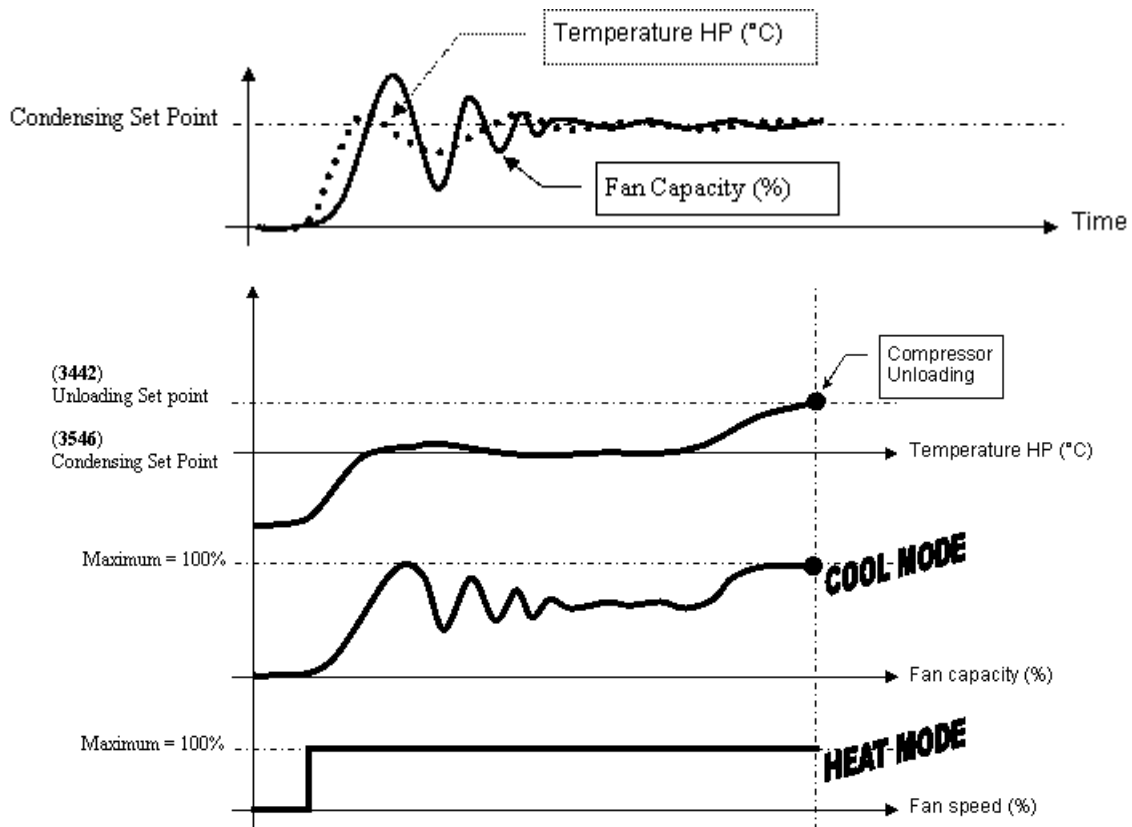

### 14.3 - Settings

The different settings to adjust the condensing control are available in the menu:

- **(3546):** Condensing set point temperature.

## 15 - FAN SMART ACOUSTIC SYSTEM™

### 15.1 - Function

The CLIMATIC™ 60 controls the fan speed limit by the Smart Acoustic System™ which allows progressive adaptation of the unit to the building load while respecting the noise level constraints and the operating limits.

### 15.2 - Description

The maximum sound level and the fan strategies can be adjusted according to the schedule mode in order to benefit from the different modes “High performance”, “Quiet” and “Quiet++” operation as well as in heating or cooling mode.

The acoustic mode offers 2 possibilities to manage the condenser fan:

#### 15.2.1 - “Quiet”

In this mode, the fan capacity is limited according to the sound level desired. For fan using low / high speed, the high speed is locked. In case of condensing temperature too high, the CLIMATIC™ 60 unlocks the limit or the high speed to prevent from unloading compressor.

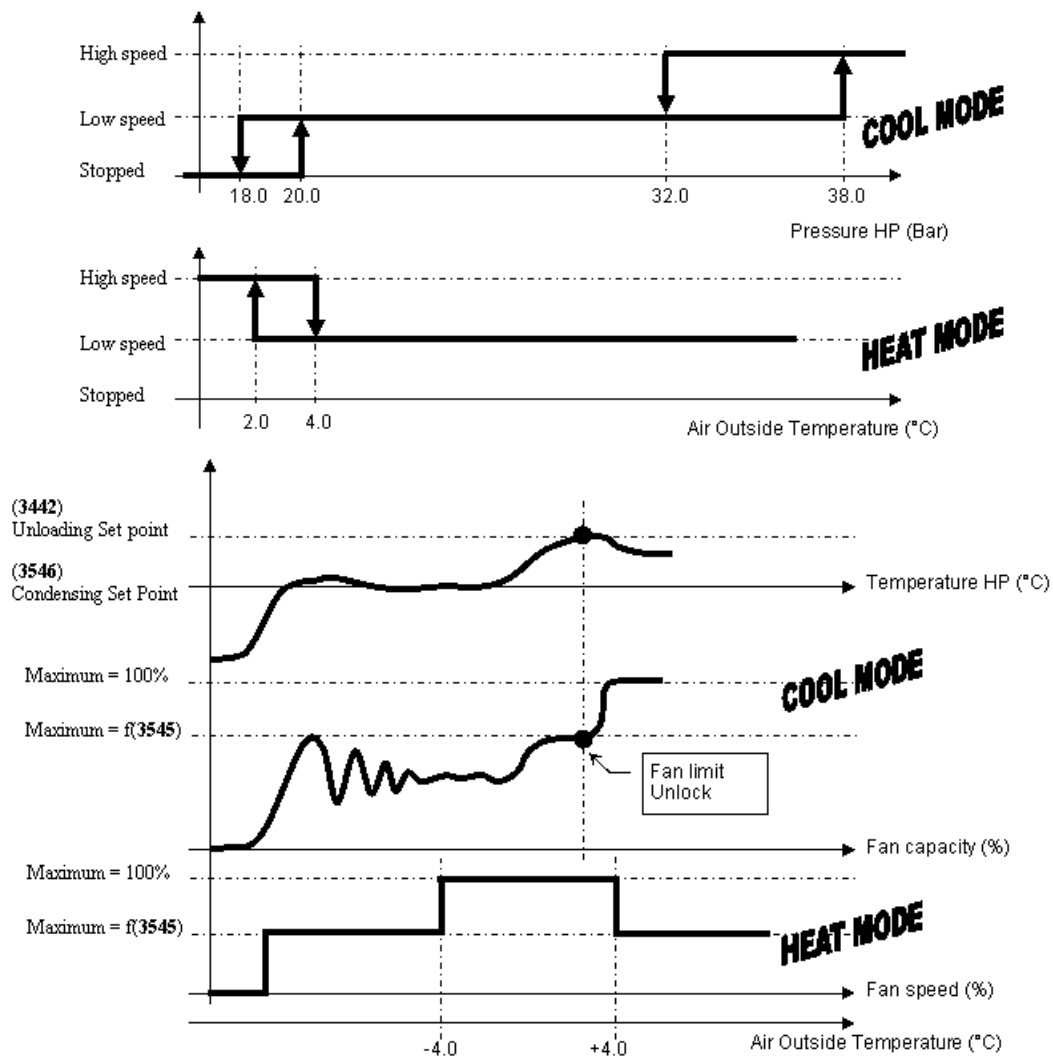

15.2.2 - “Quiet++”

This mode is similar to the “Quiet” mode except that the fan speed limit or the high speed is never unlocked. In case of condensing temperature too high, the CLIMATIC™ 60 will unload a compressor to prevent from HP security.

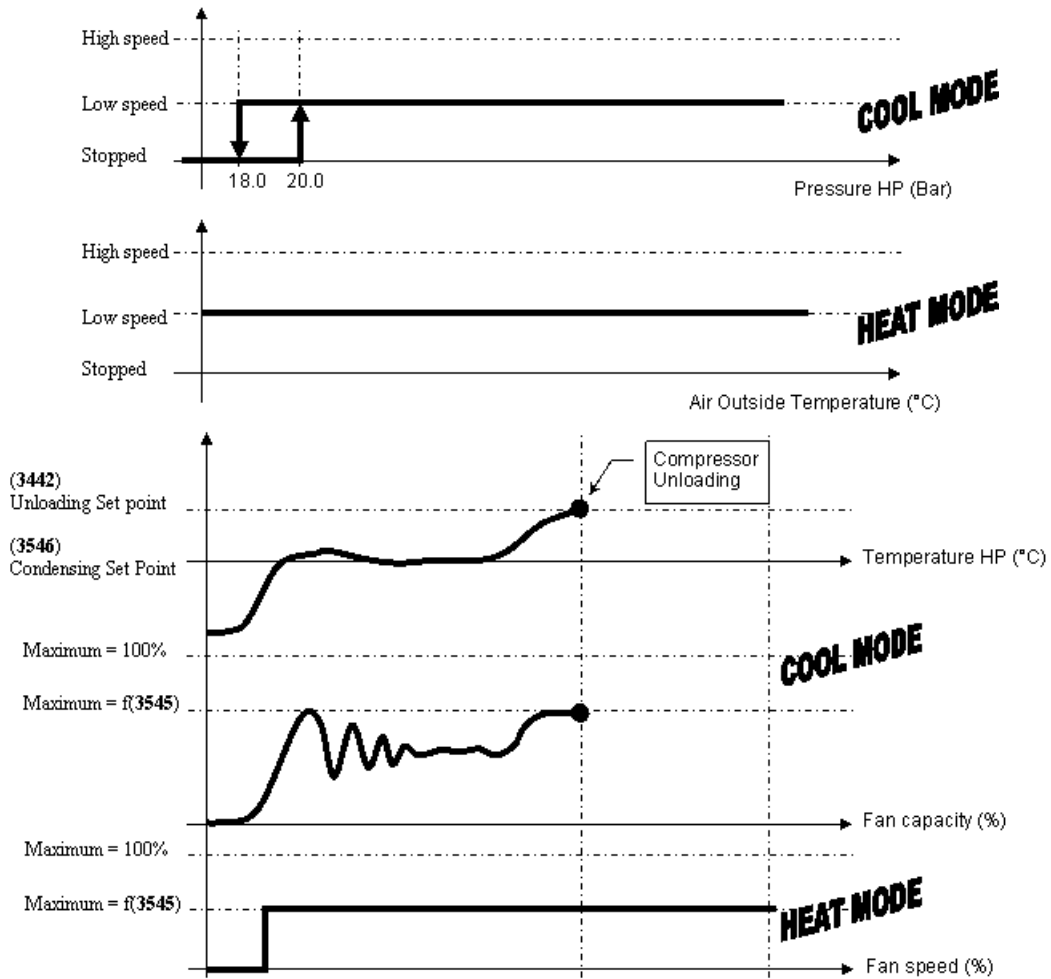

The Smart Acoustic System™ can be adjusted according to the scheduling and can take different value for each schedule mode (A, B, C, D, and BMS).

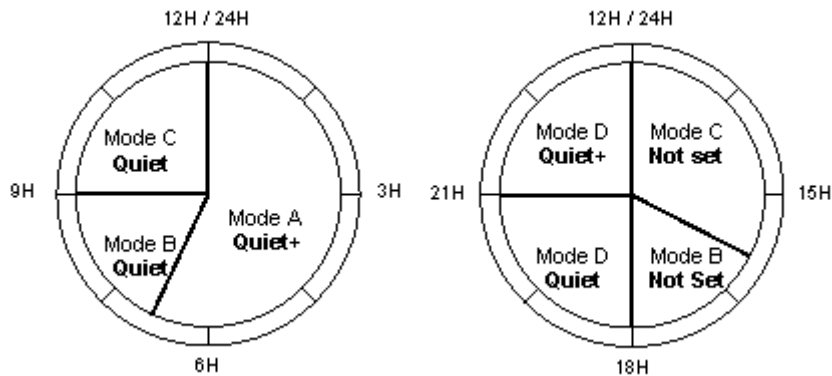

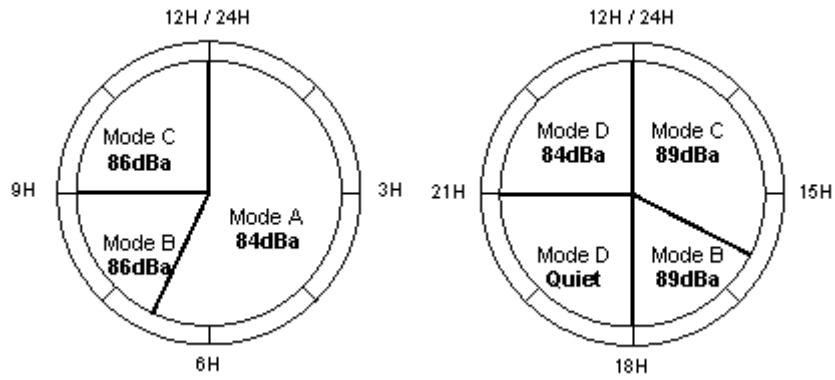

### 15.3 - Settings

The different settings to adjust the acoustic mode are available in the menu:

- (3544): Acoustic mode,
- (3545): Maximum sound level noise (except for fan with low / high speed).

## 16 - COIL DEFROST

### 16.1 - Function

The CLIMATIC™ 60 manages defrost procedure to avoid ice on the evaporator coil in heating pump mode (winter season).

### 16.2 - Description

To avoid the icing of the external air exchanger during winter operating, it's necessary to reverse the refrigerant cycle. There are 2 defrost mode:

- Cyclic mode,
- Dynamic mode (Not available in the software CH060 Vers.001).

The defrost procedure is activated if the following conditions are met during 1 minute:

- The outside air temperature is  $\leq$  **(3562)**,
- One of the compressor(s) on the circuit has been running for a time  $\geq$  **(3564)** since the last defrost,
- The saturation temperature is  $\leq$  **(3563)**.

The defrost procedure is characterised by the following steps:

- 1) Start electrical heater during 2 min (Only rooftop with electrical heater),
- 2) Stop the compressors on the concerning circuit,
- 3) Wait for 30s to equalise the pressure in the circuit,
- 4) Start all compressors on the circuit (if the outlet T° is not too low),
- 5) Reverse the reversing valve when  $\Delta P > 2$  bars,
- 6) Start all condenser fans when the HP  $\geq 55.0^\circ\text{C}$  in order to dry the coil,
- 7) Stop all condenser fans when the HP  $\leq 40.0^\circ\text{C}$ ,
- 8) Repeat the steps 4) to 5) 3 times,
- 9) Stop the compressors on the concerning circuit,
- 10) Wait for 1 min to equalise the pressure in the circuit,
- 11) End of procedure; restart the unit in heating mode.
- 12) Reverse the reversing valve when  $\Delta P > 2$  bar.

#### **Note:**

- In case of alarm on the circuit during the defrost procedure, the defrosting is cancelled.
- If the HP pressure doesn't reach  $55^\circ\text{C}$  after 6 min, during the step 6), the defrost procedure is cancelled.
- During the step 4) the compressor(s) could not start in order to not decrease too much the water temperature of the system.

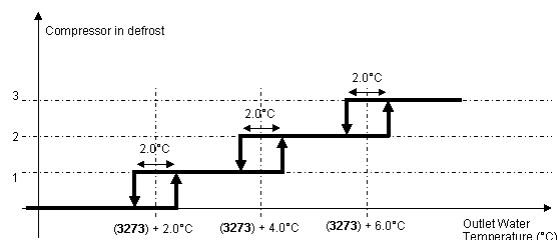

### 16.3 - Settings

The different settings to adjust the defrosting procedure are available in the menu:

- **(3561)**: Defrost mode (Cyclic, Dynamic),
- **(3562)**: Minimum of outside air temperature to enable defrost procedure,
- **(3563)**: Critical saturation temperature to enable defrost procedure
- **(3564)**: Minimum of interval time to enable defrost procedure.



**17 - WATER CONDENSER**

/\*\*\*\*\*/  
UNDER CONSTRUCTION  
/\*\*\*\*\*/

## **18 - FREECOOLING**

### **18.1 - Function**

The freecooling option ensures to reduce the electrical consumption using the outside air temperature to produce cool water.

### **18.2 - Description**

The freecooling uses water coil with helicoids fans control by the CLIMATIC™ 60. The freecooling has a higher priority face to the compressors. Once the freecooling capacity is over 95% for 2 min, the compressors can be engaged if necessary in order to reach the cooling set point. If the freecooling capacity decreases below 90%, the capacity factor of the compressor(s) capacity is locked to give the priority to the freecooling.

The freecooling is enabled if the following conditions are met:

- The unit is ready (On/Off, water flow, none alarm, etc..),
- The freecooling fan driver is operating (none alarm)
- Outside temperature < (Inlet temperature – 3°C).

### **18.3 - Settings**

The setting to configure the freecooling option is available in the menu:

- **(3164)**: Configuration of the freecooling option.

## **19 - ELECTRICAL HEATER**

### **19.1 - Function**

The electrical heater option is an additional heating capacity to help the heat pump to reach the set point during hard winter period.

### **19.2 - Description**

The electrical heater option has both utilisations:

#### **19.2.1 - Antifreeze heater**

In this case, the heater is used to prevent the evaporator water from antifreeze. The heater is activated when the low alarm temperature appears in cooling mode or when the safety low temperature is reached in heating mode.

#### **19.2.2 - Auxiliary heater**

The heater is activated when the water temperature is far from the set point. In this case, the heater is used to help the compressors to reach the heating set point.

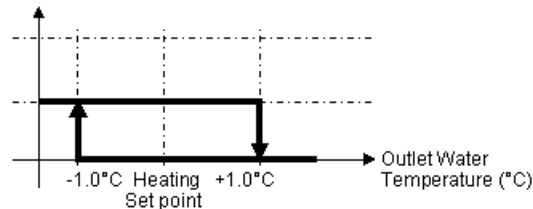

### **19.3 - Settings**

The setting to configure the electrical heater is available in the menu:

- **(3164)**: Configuration of the electrical heater.

---

## **20 - POWER FACTOR CORRECTOR**

### **20.1 - Function**

The power factor correction is an additional capacitor bank to compensate the apparent power energy.

### **20.2 - Description**

The CLIMATIC™ 60 controls the status of the circuit breaker to inform (generate an alarm) in case of short circuit in the capacitor bank.

### **20.3 - Settings**

The setting to configure the power factor correction is available in the menu:

- **(3163)**: Configuration of the power factor correction.

## 21 - MASTER / SLAVE

### 21.1 - Function

The CLIMATIC™ 60 offers possibilities to connect up to **8 units** to allow relationship between each unit in order to perform the system.

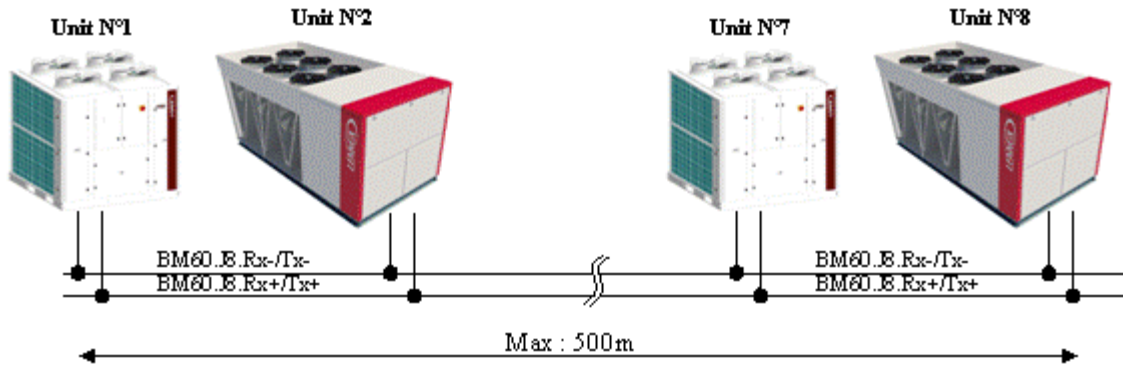

The pLAN bus is connected to Climatic™60 on the J8 connector of board BM60. A star connection is not recommended. For an optimum operation it is advised to connect a maximum of two cables per unit. The cable length should not exceed 500m and must use a 2 pairs with general shield like LiYCY-P (0.34 mm²).

### 21.2 - Description

There are 2 different modes to manage the units (“Cascade” & “Backup”)

#### 21.2.1 - The cascade mode:

Used to engage additional cooling / heating capacity in order to reach the water set point. The cascade operating includes 2 modes:

1. **Twin mode:** the units work simultaneously in order to equalize the number of compressors stages to perform the capacity of the unit. The control manages only the increasing of capacity. The decreasing of stage(s) is controlled individually by each unit. As well the capacity power factor is controlled individually on each unit according to its demand.
2. **Chain mode:** the units start one after the other in serial sequence. In case of evaporator pump(s) in the unit, the pump(s) is engaged according to the demand of the system.

#### 21.2.2 - The backup mode

Used to help the system in case of alarm(s) on the unit running. The unit in standby will start only if one of the other unit(s) running is in alarm. In this case the unit in alarm will be stopped and replace by the one which was in standby.

The CLIMATIC™ 60 manages also the rotation between the units declared. . In “Cascade” mode, that means that the first unit to start will change every week. In “Rol.Backup” mode, the unit in “Backup” is swapped every week.

#### Example:

In case of 4 units, the rotation is as follow:

Week	Example	Unit rotation
Week (n modulo 5)	Week 1	....U1→ U2 → U3→ U4→....
Week (n+1 modulo 5)	Week 2	....U4→ U1 → U2→ U3→....
Week (n+2 modulo 5)	Week 3	....U3→ U4 → U1→ U2→....
Week (n+3 modulo 5)	Week 4	....U2→ U4 → U3→ U1→....

The unit selected in standby is the one which has the higher critical(s) alarm(s). In case of disconnection of the slave(s) unit(s) (@pLAN = 2→8) from the master unit (@pLAN = 1) on the pLAN bus, the disconnected unit will operate alone.

## 22 - DISPLAY DC60

### 22.1 - Function

The DC60 display is customized for the user to show a global operating overview of the unit and allow access to some settings. In case of remote display, the cable length should not exceed 30m.

### 22.2 - Description

The DC60 terminal displays various status of the unit and offers the possibility to override the initial operating of the unit. Use the wheel button to display the data desired in the big area. The small area specifies the type of the data displayed.



#### 22.2.1 - Set point "SET":

Specify the evaporator water set point calculated by the CLIMATIC™ 60. The set point can be modified directly by the DC60. Note that the select value will be automatically overwritten by the CLIMATIC™ 60 when the actual zone will change (Z0→Z6) if a scheduling has been defined.

#### 22.2.2 - Outlet temperature "OUT":

Specify the evaporator water outlet temperature.

#### 22.2.3 - Inlet temperature "IN"

Specify the evaporator water inlet temperature.

#### 22.2.4 - Outside temperature "Air"

Specify the outside air temperature.

#### 22.2.5 - Alarm code "AL-"

Specify the alarm(s) code(s) active.

#### 22.2.6 - Alarm clear "CL-"

Specify the alarm reset set point. To reset the active alarms, press the wheel button and set to 1 to active the reset. The setting is automatically cleared by the CLIMATIC™ 60.

#### 22.2.7 - Low pressure "LP-1"

Specify the low pressure of the circuit 1.

#### 22.2.8 - High pressure "HP-1"

Specify the high pressure of the circuit 1.

#### 22.2.9 - Superheating "SH-1"

Specify the superheating temperature of the circuit 1.

#### 22.2.10 - Low pressure "LP-2"

Specify the low pressure of the circuit 2.

#### 22.2.11 - High pressure "HP-2"

Specify the high pressure of the circuit 2.

#### 22.2.12 - Superheating "SH-2"

Specify the superheating temperature of the circuit 2.

**22.2.13 - Schedule zone**

specify the schedule operating zone.



The terminal DC60 also displays the status of the main component of the unit in the status area. The icons can take different appearance according to the status of the component.

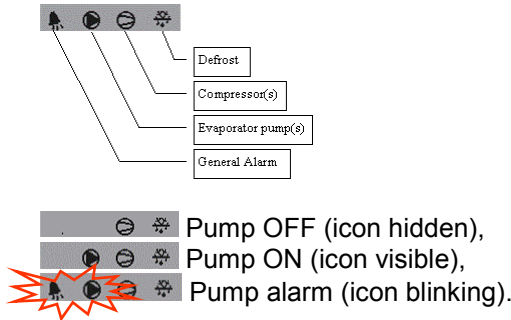

**22.3 - Settings**

The CLIMATIC™ 60 offers possibilities of override operations.

**22.3.1 - On/Off**

When the “power” button is pressed during few seconds, the unit is ordered to start or stop. When the unit is “OFF”, the clock is displayed.

**22.3.2 - Changeover mode**

The changeover mode (cool / heat) can be modified by the terminal DC60 by pressing the “mode” button.



When the “Auto” mode is selected, the icon “Cool” or “Heat” is displayed to signal the actual operating mode of the unit. Due to the communication delay, after pressing the “mode” button, it is well advised to wait few seconds, the time to refresh of th icon on the display.

**22.3.3 - Clock:** There is two way to modify the clock hour:

- a. Press the “clock” button during few seconds. When the hour blinking turn the wheel button to select the desired hour and validate by pressing the wheel button. Once the hour validate, repeat the procedure for the minute and the weekday.
- b. Press the “On/off” and “Fan” buttons simultaneously during few seconds. When the terminal displays “CODE” select the password “22” and validate by pressing the wheel button. Then select the item to modify (“year” → Year, “mont→ Month, “nday” →day of the month, “uday” → weekday, “hour” → Hour, “minS”→Minute.

## 23 - DISPLAY DS60

### 23.1 - Function

The DS60 terminal is a plug and play display, designed for maintenance and service people who want to access to advanced functionalities.

### 23.2 - Description

The terminal address must be assign to establish the communication with the CLIMATIC™ 60. The procedure to configure the DS60 is:

- 1) Press the buttons “↓”, “↑”, “←” keys at same time during 5 seconds,
- 2) Use the “←” key to move the cursor on the address number,
- 3) Use the “↓”, “↑” keys to select the value “31” for the DS60 (“32” for the DS50) and confirm with the “←” key (The cursor go directly to the next data).



- 4) If the address has been modified, the next screen is displayed. In this case restart to the step 1).



- 5) Use the “↓”, “↑” keys to select the desired address of the CLIMATIC™ 60. The CLIMATIC™ 60 address must be at the address “1” except if there is several units linked. The next screen is displayed.



- 6) Press the “←” key to go to the next step.



7) The following screen describe the type of connection used. Set the display as a Private “Pr” terminal. The other terminals (Trm2 and Trm3) are not used. So their addresses must be adjusted to “None”. Finally confirm the modifications and swapping the text “No” to “Yes” and validate with the “←” key.

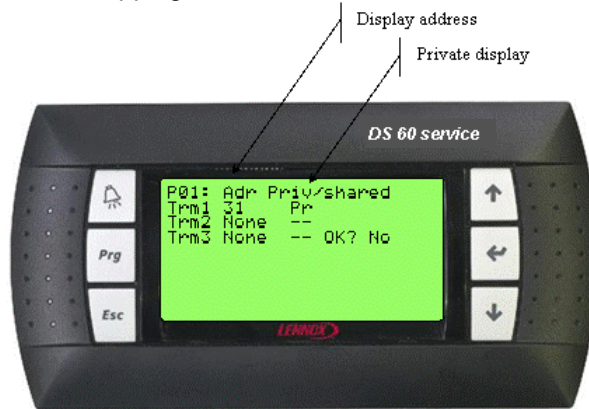

The first screen after a start up contains the main information about the CLIMATIC™ 60’s software.

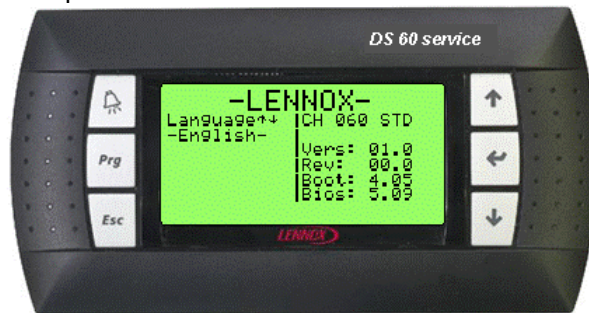

The DS60 is organised in 3 menus:

- (1000): Historic of alarms,
- (2000): User menus for maintenance people,
- (3000): Expert menus for service people (restricted area).



To access to the historic of alarms, press the “ALARM” key when you are in the main menu (0000). The CLIMATIC™ 60 saves up to the last 32 alarms. An alarm active is signal by the symbol “\*” whereas an alarm inactive is symbolized by the “=”.

To reset the current active alarm(s) press the “ALARM” key.

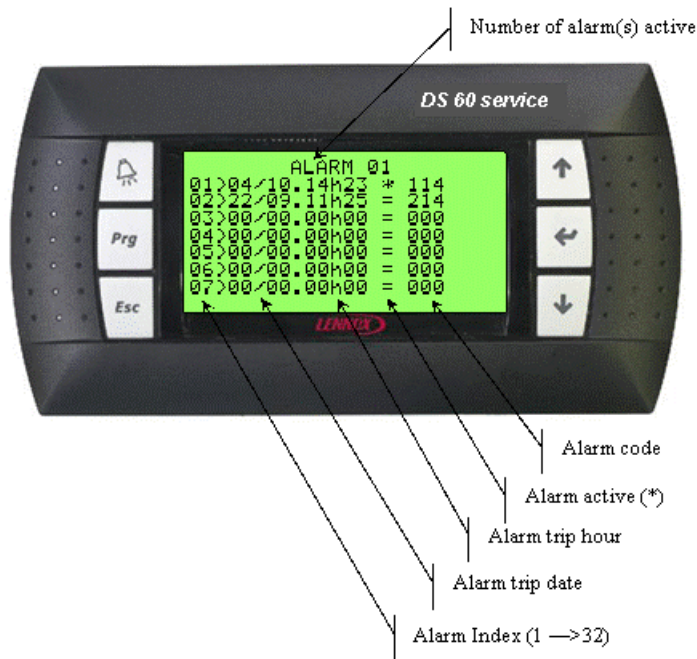

The menu is organised in arborescence tree with submenus. The actual menu is identified by the number in parentheses in the top left corner of the screen.

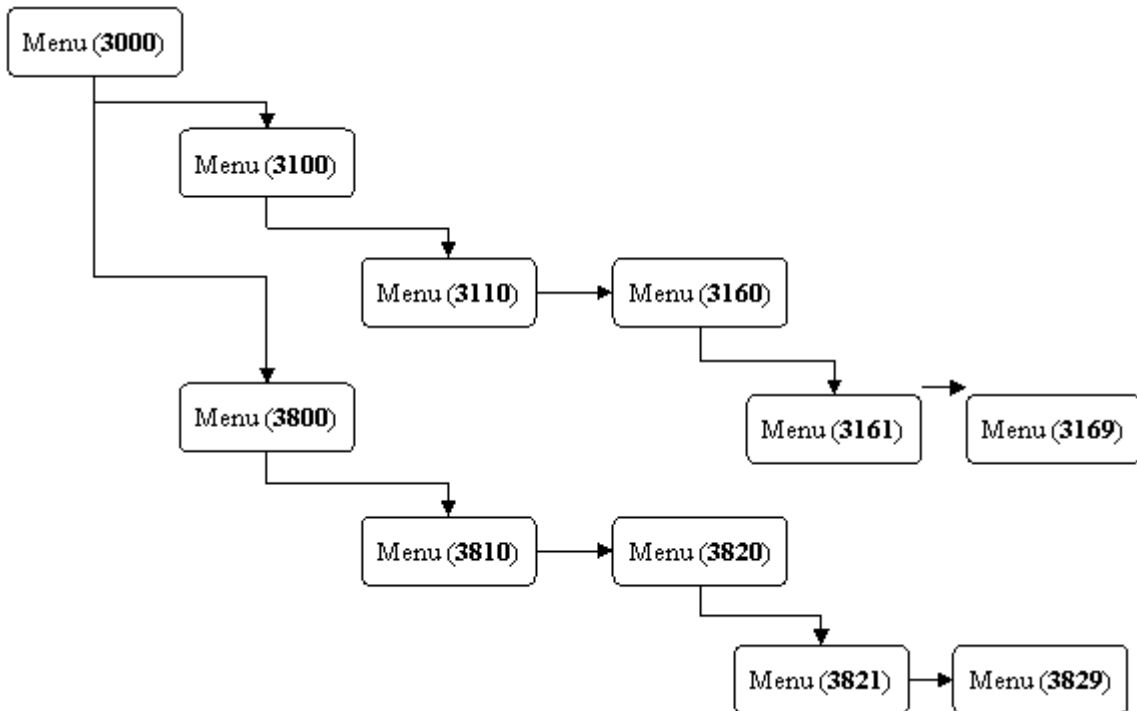

The “↓” and “↑” keys are used to move the cursor on the desired item. Then use the “←” key to enter in the submenu selected. To escape a menu uses the key “ESC”.

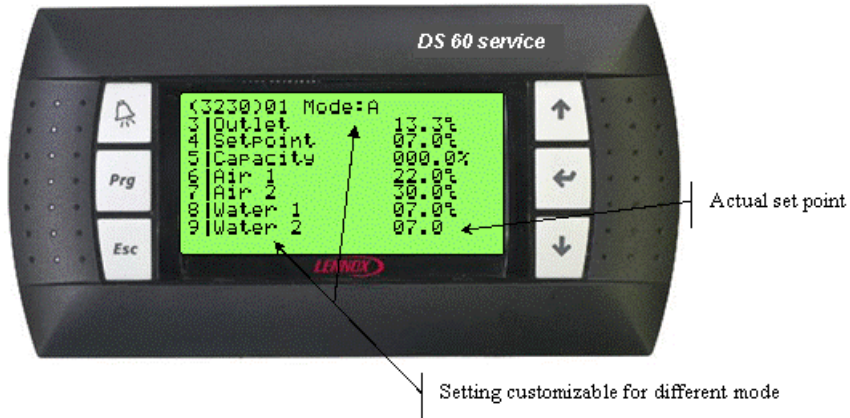

The submenus contain 2 types of data: The read only data (like a temperature probe for example) and the read/write setpoints (like the cooling water setpoint for example). The data are identified by a cursor symbol ">" whereas the setpoint are identify by a symbol ">>".

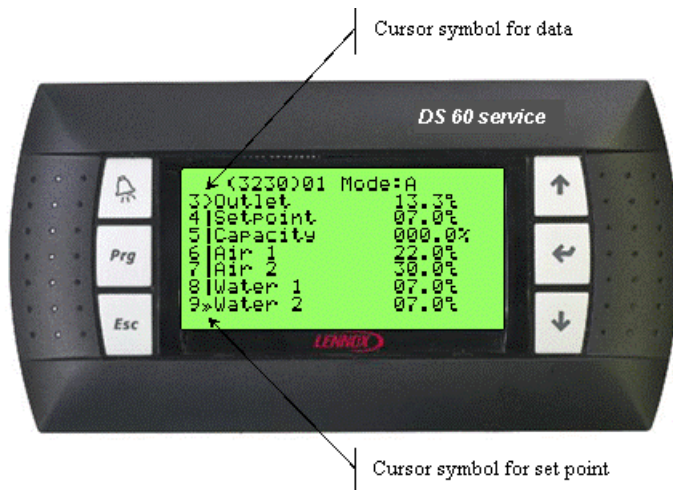

To modify a setting, move the cursor on the desired item and press the "←" key. A new screen displays information concerning this set point. To modify it use the "↓" and "↑" keys and validate by pressing the "←" key. If the setting is customizable according to the schedule mode, press the "PRG" key to select different value for the mode A, B, C, D.



⚡: To increment or decrement quickly the setting, hold the "↓" or "↑" keys during few time.

## 24 - BMS

### 24.1 - Function

BMS (Building Management Systems) are systems for the integrated management of all the technological functions of a building, including access control, safety, fire detection, lighting, intelligent elevators, and Air-Conditioning. The resulting advantages of such solutions as simpler and more efficient management of the building from a single control station, reduction in running costs, possibility of statistical analysis of all data, immediate identification of and response to faults and alarms, amply justify the little extra cost of the Air-Conditioning unit BMS connectable. Today not only the quality and the reliability of the instruments are important, but also the degree of external connectivity they can offer.

### 24.2 - Description

The communication bus is connected on Climatic™60's serial card board on the BM60. A star connection is not recommended, for an optimum operation it is advised to connect a maximum of two cables per unit. In case of RS485 bus, a resistance of 120Ω 1/4W can be connected on the last unit between the terminals + and -.

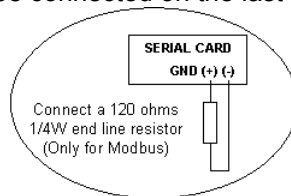

The connection must be carried out by the following cable:

- Cable length up to 1000m: LiYCY-P (0.34 mm<sup>2</sup>), 2 pairs with general shield.

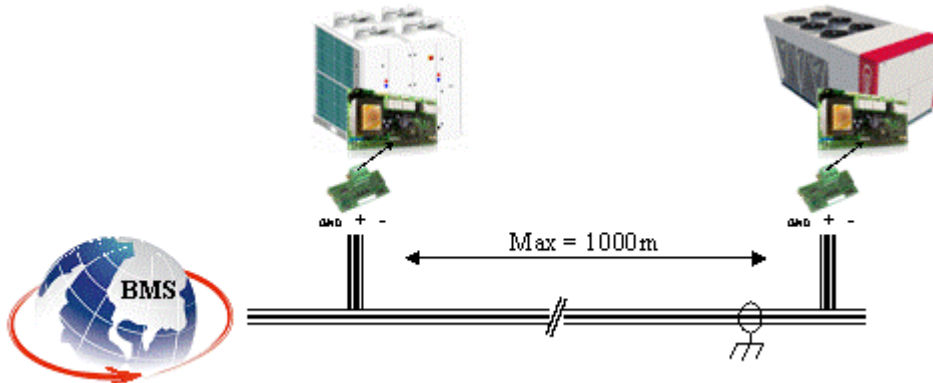

The CLIMATIC™ 60 offers different possibilities of BMS protocol:

- Modbus RTU,
- Trend,
- Bacnet,
- Lon Works.

Modbus is a serial communications protocol published by Modicon in 1979, and has become a standard communications protocol in industry, and is now the most commonly available method of connecting industrial electronic devices.

Controllers communicate using a master–slave technique, in which only one device (the master) can initiate transactions (called 'queries'). The other devices (the slaves) answer by supplying the requested data to the master, or by taking the action requested in the query.

LENNOX units implement Modbus slave protocol with the following settings:

<b>Serial Line</b>	RS485 (EIA/ TIA - 485 Standard)
<b>Transmission Mode</b>	RTU (Remote Terminal Unit)
<b>Baudrate</b>	1200→19200 Bauds
<b>Data bits</b>	8 bits
<b>Parity</b>	None
<b>Stop bits</b>	1 bit

### 24.3 - Settings

The different settings to configure the BMS are available in the menu:

- **(3826)**: Unit identification number on the BMS network,
- **(3827)**: Protocol communication with the BMS,
- **(3828)**: Baudrate with the BMS.

## 25 – INPUTS / OUTPUTS CLIMATIC BOARDS

### 25.1 – Digital inputs and digital outputs

ELECTRICAL INPUTS/OUTPUTS MAPPING EAC/EAR UNITS							
CLIMATIC™ 60 Main Board							
Digital Input				Digital Output			
J4.ID1		C.1	Compressor	J12.NO1		C.1	Compressor 1
J4.ID2		C.1	High pressure safety	J12.NO2		C.1	Compressor 2
J4.ID3		C.1	Condenser fan	J12.NO3		C.1	Condenser fan
J4.ID4		Unit	Customer main board ID4	J13.NO4		C.2	Compressor 1
J4.ID5		Unit	Evaporator flow	J13.NO5		C.2	Compressor 2
J4.ID6	Opt°	Unit	Evaporator pump	J13.NO6		C.2	Condenser fan
J4.ID7		Unit	Customer main board ID7 (Remote On/Off)	J14.NO7 J14.NC7		Unit	Customer main board NO7 (General Alarm)
J6.ID8		C.2	Compressor	J15.NO8	Opt°	Unit	Electric heater
J6.ID9		C.2	High pressure safety	J15.NO9	EAR	C.1	V4V
J6.ID10		C.2	Condenser fan	J15.NO10	EAR	C.2	V4V
				J15.NO11	Opt°	Unit	Evaporator Pump 1
				J15.NO12	Opt°	Unit	Evaporator Pump 2

### 25.2 – Analog inputs and analog outputs

ELECTRICAL INPUTS/OUTPUTS MAPPING EAC/EAR UNITS							
CLIMATIC™ 60 Main Board							
AI				AO			
J3.B1	NTC	Unit	Evaporator water inlet temperature	J5.Y1	0/10V	C.1	Condenser fan
J3.B2	NTC	Unit	Evaporator water outlet temperature	J5.Y2	0/10V	C.2	Condenser fan
J3.B3	NTC	C.1	Liquid gas temperature	J5.Y3	PWM	C.1	Low/High Speed
J3.B4	NTC	C.1	Suction gas temperature				
J3.B5	4/20	C.1	Condenser gas pressure				
J3.B6	0/5V	C.1	Evaporator gas pressure				
J3.B7	NTC	Unit	Outside air temperature				
J18.B8	NTC	C.2	Liquid gas temperature	J5.Y4	PWM	C.2	Low/High Speed
J18.B9	NTC	C.2	Suction gas temperature				
J18.B10	4/20	C.2	Condenser gas pressure				
J18.B11	0/5V	C.2	Evaporator gas pressure				
J18.B12	NTC						



**25.3 – Serial port**

ELECTRICAL INPUTS/OUTPUTS MAPPING EAC/EAR UNITS			
CLIMATIC™ 60 Main Board			
SERIAL PORT			
J6	Opt°	Unit	BMS Customer Bus
J7		Unit	DS60 Terminal Display
J8		Unit	CL60 external Bus
J9			
J10		Unit	CL60 internal Bus

**26 - SETTINGS LIST**

Level 1	Item	Level 2	Item	Level 3	Item	Level 4	Item	R/W/Z	Unit	Min	Std	Max	Description
1000	Alarm	1100	***	1110	***	1111	***						
2000	User	2100	Unit	2110	General	2111	On/Off	R/W	*	0	*	1	General On/Off
	User		Unit		General	2112	Sw On/Off	R	*	0	*	1	Remote On/Off
	User		Unit		General	2113	Run	R/W/Z	*	0	1	1	Enable
	User		Unit		General	2114	Reset Alarm	R/W	*	0	0	1	Reset the active alarm(s)
	User		Unit		General	2115	Clear Alarm	R/W	*	0	0	1	Clear the historic of alarm(s)
	User		Unit		General	2116	Elec.Box	R	°C	-50,0	*	105,0	Electrical box T°
	User		Unit		General	2117	Status	R	*	*	*	*	General status
	User		Unit		General	2118	Test	R/W	*	0=Not set, 1=Quickly, 2=Wizard, 3=Daily Task, 4=Weekly Task, 5=Defrost C1, 6=Defrost C2, 7=Defrost C1&2, 8=HP C1, 9=HP C2, 10=HP C1&2.			Test
	User		Unit		General	2119	Restore	R/W	*	0=Not set, 1=DC+Bms, 2=Schedule, 3=Factory, 4=Store User, 5=Restore User.			Restore the settings parameters
	User		Unit	2120	Clock	2121	Hour	R/W	HH	0	*	23	Hour clock setting
	User		Unit		Clock	2122	Minute	R/W	mm	0	*	59	Minute clock setting
	User		Unit		Clock	2123	Day	R/W	DD	1	*	31	Day clock setting
	User		Unit		Clock	2124	Month	R/W	MM	1	*	12	Month clock setting
	User		Unit		Clock	2125	Year	R/W	yy	1	*	99	Year clock setting
	User		Unit		Clock	2126	Win/Sum	R/W	*	0	1	1	Automatic update for winter/summer time
	User		Unit	2130	Schedule Status	2131	Weekday	R	D	1	*	7	Actual day of the week
	User		Unit		Schedule Status	2132	Day	R	DD	1	*	31	Actual day of the month
	User		Unit		Schedule Status	2133	Year	R	YY	1	*	99	Actual year
	User		Unit		Schedule Status	2134	Hour	R	HH	0	*	23	Actual hour
	User		Unit		Schedule Status	2135	Minute	R	mm	1	*	59	Actual minute
	User		Unit		Schedule Status	2136	Zone	R	*	0	*	6	Actual schedule zone
	User		Unit		Schedule Status	2137	Mode	R	*	1	*	5	Actual schedule mode



Level 1	Item	Level 2	Item	Level 3	Item	Level 4	Item	R/W/Z	Unit	Min	Std	Max	Description
	User		Unit	2140	Schedule Time	2141	Time Z0	R/W	HH	0	24	24	Start time zone 0
	User		Unit		Schedule Time	2142	Time Z1	R/W	HH	0	24	24	Start time zone 1
	User		Unit		Schedule Time	2143	Time Z2	R/W	HH	0	24	24	Start time zone 2
	User		Unit		Schedule Time	2144	Time Z3	R/W	HH	0	24	24	Start time zone 3
	User		Unit		Schedule Time	2145	Time Z4	R/W	HH	0	24	24	Start time zone 4
	User		Unit		Schedule Time	2146	Time Z5	R/W	HH	0	24	24	Start time zone 5
	User		Unit		Schedule Time	2147	Time Z6	R/W	HH	0	24	24	Start time zone 6
	User		Unit	2150	Schedule Mode	2151	Zone Z0	R/W	*	1	1	5	Mode during zone 0
	User		Unit		Schedule Mode	2152	Zone Z1	R/W	*	1	1	5	Mode during zone 1
	User		Unit		Schedule Mode	2153	Zone Z2	R/W	*	1	1	5	Mode during zone 2
	User		Unit		Schedule Mode	2154	Zone Z3	R/W	*	1	1	5	Mode during zone 3
	User		Unit		Schedule Mode	2155	Zone Z4	R/W	*	1	1	5	Mode during zone 4
	User		Unit		Schedule Mode	2156	Zone Z5	R/W	*	1	1	5	Mode during zone 5
	User		Unit		Schedule Mode	2157	Zone Z6	R/W	*	1	1	5	Mode during zone 6
	User		Unit	2160	Anticipation	2161	Foot	R/W	°C	-10,0	10,0	20,0	Bottom of the slope
	User		Unit		Anticipation	2162	Gradient	R/W	m/°C	0	0	100	Slope value in minute per degrees



Level 1	Item	Level 2	Item	Level 3	Item	Level 4	Item	R/W/Z	Unit	Min	Std	Max	Description
	User		Unit	2170	Cust.Relay	2171	BM.NO7	R/W	*	0=Not Set, 1=Alarm, 2=Fault, 3=Alarm C1, 4=Alarm C2, 5=Alarm Cond, 6=Alarm Pump Evap, 7=Alarm Flow Evap, 8=Enable, 9=Avaiable, 10=Run, 11=Run 100%, 12=Cooling Mode, 13=Heating Mode, 14=Dead Zone Mode, 15=Zone 0, 16=Zone 1, 17=Zone 2, 18=Zone 3, 19=Zone 4, 20=Zone 5,	21=Zone 6, 22=Mode A, 23=Mode B, 24=Mode C, 25=Mode D, 26=Mode BMS, 27=Elec.Heater 1, 28=Elec.Heater 2, 29=Elec.Heater 3, 30=Elec.Heater 4, 31=Free BM.NO7, 32=Free BE.NO1, 33=Free BE.NO2, 34=Free BE.NO3, 35=Free BE.NO4, 36=Not Used, 37=Not Used, 38=Not Used, 39=Not Used, 40=Freecooling, 41=NSR 1, 42=NSR 2, 43=NSR 3, 44=NSR 4, 45=NSR 5.		Configuration of the free output BM.NO7
	User		Unit		Cust.Relay	2172	BE.NO1	R/W	*	*	*	*	Configuration of the free output BE.NO1
	User		Unit		Cust.Relay	2173	BE.NO2	R/W	*	*	*	*	Configuration of the free output BE.NO2
	User		Unit		Cust.Relay	2174	BE.NO3	R/W	*	*	*	*	Configuration of the free output BE.NO3
	User		Unit		Cust.Relay	2175	BE.NO4	R/W	*	*	*	*	Configuration of the free output BE.NO4

Level 1	Item	Level 2	Item	Level 3	Item	Level 4	Item	R/W/Z	Unit	Min	Std	Max	Description
	User		Unit	2180	Cust.Switch	2181	BM.Id4	R/W	*	0=Not Set, 1=On/Off, 2=Reset Alarm 3=Swap 2° SP, 4=Cooling, 5=Heating, 6=Dead Zone, 7=Delay Defrost, 8=Disable C1, 9=Disable C2, 10=Disable C1Cp1, 11=Disable C1Cp2, 12=Disable C1Cp3, 13=Disable C2Cp1, 14=Disable C2Cp2, 15=Disable C2Cp3, 16=Mode A, 17=Mode B,	18=Mode C, 19=Mode D, 20=Mode BMS, 21=Heater Elec., 22=Free BM.Id4, 23=Free BM.Id7, 24=Free BE.Id1, 25=Free BE.Id2, 26=Free BE.Id3, 27=Free BE.Id4, 28=Not Used, 29=Not Used, 30=Not Used, 31=Not Used, 32=Not Used, 33=Freecooling, 34=Corrector FP, 35=NSR 1, 36=NSR 2, 37=NSR 3, 38=NSR 4, 39=NSR 5, 40=NSR 6.		Configuration of the free input BM.Id4
	User		Unit		Cust.Switch	2182	BM.Id7	R/W	*	*	*	*	Configuration of the free input BM.Id7
	User		Unit		Cust.Switch	2183	BE.Id1	R/W	*	*	*	*	Configuration of the free input BE.Id1
	User		Unit		Cust.Switch	2184	BE.Id2	R/W	*	*	*	*	Configuration of the free input BE.Id2
	User		Unit		Cust.Switch	2185	BE.Id3	R/W	*	*	*	*	Configuration of the free input BE.Id3
	User		Unit		Cust.Switch	2186	BE.Id4	R/W	*	*	*	*	Configuration of the free input BE.Id4
	User		Unit	2190	Cust.Signal	2191	BE.B1	R/W	*	0=Not Set, 1=Water Sp, 2=Offset Sp, 3=Free BE.B1, 4=Free BE.B2, 5=Free BE.B3, 6=Free BE.B4, 7=Discharge 1, 8=Discharge 2,	9=Discharge 3, 10=Discharge 4, 11=Condensor Inlet, 12=Condensor Outlet, 13=Freecooling Inlet, 14=Recovery Inlet, 15=Recovery Outlet, 16=NSR 1, 17=NSR 2, 18=NSR 3, 19=NSR 4.		Configuration of the free input BE.B1
	User		Unit		Cust.Signal	2192	BE.B2	R/W	*	*	*	*	Configuration of the free input BE.B2
	User		Unit		Cust.Signal	2193	BE.B3	R/W	*	*	*	*	Configuration of the free input BE.B3
	User		Unit		Cust.Signal	2194	BE.B4	R/W	*	*	*	*	Configuration of the free input BE.B4

Level 1	Item	Level 2	Item	Level 3	Item	Level 4	Item	R/W/Z	Unit	Min	Std	Max	Description
User		2200	Water	2210	General	2211	Inlet	R	°C	-50,0	*	105,0	Evaporator inlet probe T°
User			Water		General	2212	Inlet Ref	R	°C	-50,0	*	105,0	Evaporator inlet reference T°
User			Water		General	2213	Outlet	R	°C	-50,0	*	105,0	Evaporator outlet probe T°
User			Water		General	2214	Outlet Ref	R	°C	-50,0	*	105,0	Evaporator outlet reference T°
User			Water		General	2215	Delta T°	R	°C	-50,0	*	105,0	Evaporator delta T° (Inlet-Outlet)
User			Water		General	2216	Setpoint	R	°C	-50,0	*	105,0	Evaporator set point
User			Water		General	2217	Capacity	R	%	-50,0	*	105,0	Evaporator capacity
User			Water		General	2218	Flow	R	*	0	*	1	Evaporator flow switch
User			Water	2220	Changeover	2221	Status	R	*	*	*	*	Changeover status
User			Water		Changeover	2222	Outside	R	°C	-50,0	*	105,0	Outside air probe T°
User			Water		Changeover	2223	Outside Ref	R	°C	-50,0	*	105,0	Outside air reference T°
User			Water		Changeover	2224	Mode	R/W	*	0=Not Used, 1=Cool, 2=Heat, 3=Auto, 4=Dead zone.			Changeover mode
User			Water	2230	Cooling	2231	Status	R	*	*	*	*	Evaporator status
User			Water		Cooling	2232	Inlet	R	°C	-50,0	*	105,0	Evaporator inlet reference T°
User			Water		Cooling	2233	Outlet	R	°C	-50,0	*	105,0	Evaporator outlet reference T°
User			Water		Cooling	2234	Setpoint	R	°C	-50,0	*	105,0	Evaporator set point
User			Water		Cooling	2235	Capacity	R	°C	0,0	*	100,0	Evaporator cooling capacity
User			Water		Cooling	2236	Air 1	R/W/Z	°C	-11,0	22,0	50,0	Outside air set point X1 in cool
User			Water		Cooling	2237	Air 2	R/W/Z	°C	-11,0	30,0	50,0	Outside air set point X2 in cool
User			Water		Cooling	2238	Water 1	R/W/Z	°C	19,0	7,0	20,0	Evaporator set point X1 in cool
User			Water		Cooling	2239	Water 2	R/W/Z	°C	19,0	7,0	20,0	Evaporator set point X2 in cool
User			Water	2240	Heating	2241	Status	R	*	*	*	*	Evaporator status
User			Water		Heating	2242	Inlet	R	°C	-50,0	*	105,0	Evaporator inlet reference T°
User			Water		Heating	2243	Outlet	R	°C	-50,0	*	105,0	Evaporator outlet reference T°
User			Water		Heating	2244	Setpoint	R	°C	-50,0	*	105,0	Evaporator set point
User			Water		Heating	2245	Capacity	R	°C	0,0	*	100,0	Evaporator cooling capacity
User			Water		Heating	2246	Air 1	R/W/Z	°C	-11,0	22,0	50,0	Outside air set point X1 in heat
User			Water		Heating	2247	Air 2	R/W/Z	°C	-11,0	30,0	50,0	Outside air set point X2 in heat
User			Water		Heating	2248	Water 1	R/W/Z	°C	40,0	45,0	50,0	Evaporator set point X1 in heat
User			Water		Heating	2249	Water 2	R/W/Z	°C	40,0	45,0	50,0	Evaporator set point X2 in heat

Level 1	Item	Level 2	Item	Level 3	Item	Level 4	Item	R/W/Z	Unit	Min	Std	Max	Description
	User		Water	2250	Custom	2251	Sp 4/20mA	R	°C	4,0	*	20,0	External evaporator set point
	User		Water		Custom	2252	Sp +/-0.5°C	R	°C	-0,5	*	0,5	External offset evaporator set point
	User		Water		Custom	2253	2nd Sp	R	*	0	*	1	Second set point switch status
	User	2300	Pump	2310	Cooling P1	2311	Status	R	*	*	*	*	Evaporator pump 1 status
	User		Pump		Cooling P1	2312	Sw State	R	*	0	*	1	Evaporator pump 1 input
	User		Pump		Cooling P1	2313	Output	R	*	0	*	1	Evaporator pump 1 output
	User		Pump		Cooling P1	2314	Hour	R	HH	0	*	99999	Evaporator pump 1 output
	User		Pump		Cooling P1	2315	Flow	R	*	0,0	*	100,0	Evaporator flow switch
	User		Pump	2320	Cooling P2	2321	Status	R	*	*	*	*	Evaporator pump 2 status
	User		Pump		Cooling P2	2322	Sw State	R	*	0	*	1	Evaporator pump 2 input
	User		Pump		Cooling P2	2323	Output	R	*	0	*	1	Evaporator pump 2 output
	User		Pump		Cooling P2	2324	Hour	R	HH	0	*	99999	Evaporator pump 2 output
	User		Pump		Cooling P2	2325	Flow	R	*	0,0	*	100,0	Evaporator flow switch
	User		Pump	2330	Heating P1	2331	Status	R	*	*	*	*	Condenser pump 1 status
	User		Pump		Heating P1	2332	Sw State	R	*	0	*	1	Condenser pump 1 input
	User		Pump		Heating P1	2333	Output	R	*	0	*	1	Condenser pump 1 output
	User		Pump		Heating P1	2334	Hour	R	HH	0	*	99999	Condenser pump 1 output
	User		Pump		Heating P1	2335	Flow	R	*	0,0	*	100,0	Condenser flow switch
	User		Pump	2340	Heating P2	2341	Status	R	*	*	*	*	Condenser pump 2 status
	User		Pump		Heating P2	2342	Sw State	R	*	0	*	1	Condenser pump 2 input
	User		Pump		Heating P2	2343	Output	R	*	0	*	1	Condenser pump 2 output
	User		Pump		Heating P2	2344	Hour	R	HH	0	*	99999	Condenser pump 2 output
	User		Pump		Heating P2	2345	Flow	R	*	0,0	*	100,0	Condenser flow switch
	User		Pump	2350	Cooling Flow	2351	T.In	R	°C	-50,0	*	105,0	Evaporator T° inlet
	User		Pump		Cooling Flow	2352	T.Out	R	°C	-50,0	*	105,0	Evaporator T° outlet
	User		Pump		Cooling Flow	2353	P.In	R	Bar	0,0	*	6,0	Evaporator pressure in
	User		Pump		Cooling Flow	2354	P.Out	R	Bar	0,0	*	6,0	Evaporator pressure out
	User		Pump		Cooling Flow	2355	Delta dT	R	°C	0,0	*	20,0	Evaporator delta T°
	User		Pump		Cooling Flow	2356	Delta dP	R	Bar	0,0	*	6,0	Evaporator delta pressure
	User		Pump		Cooling Flow	2357	Capacity	R	%	0,0	*	100,0	Evaporator flow capacity
	User		Pump		Cooling Flow	2358	Flow	R	m3	0,0	*	100,0	Evaporator flow meter
	User		Pump		Cooling Flow	2359	Flow	R	*	0	*	1	Evaporator flow switch

Level 1	Item	Level 2	Item	Level 3	Item	Level 4	Item	R/W/Z	Unit	Min	Std	Max	Description
User		Pump		2360	Heating Flow	2361	T.In	R	°C	-50,0	*	105,0	Condenser T° inlet
User		Pump			Heating Flow	2362	T.Out	R	°C	-50,0	*	105,0	Condenser T° outlet
User		Pump			Heating Flow	2363	P.In	R	Bar	0,0	*	6,0	Condenser pressure in
User		Pump			Heating Flow	2364	P.Out	R	Bar	0,0	*	6,0	Condenser pressure out
User		Pump			Heating Flow	2365	Delta dT	R	°C	0,0	*	20,0	Condenser delta T°
User		Pump			Heating Flow	2366	Delta dP	R	Bar	0,0	*	6,0	Condenser delta pressure
User		Pump			Heating Flow	2367	Capacity	R	%	0,0	*	100,0	Condenser flow capacity
User		Pump			Heating Flow	2368	Flow	R	m3	0,0	*	100,0	Condenser flow meter
User		Pump			Heating Flow	2369	Flow	R	*	0	*	1	Condenser flow switch
User	2400	Compressor		2410	Circuit 1	2411	Condensing	R	Bar	-50,0	*	105,0	Condensing pressure circuit 1
User		Compressor			Circuit 1	2412	Condensing	R	°C	-50,0	*	105,0	Condensing T° circuit 1
User		Compressor			Circuit 1	2413	Saturated	R	Bar	-50,0	*	105,0	Saturated pressure circuit 1
User		Compressor			Circuit 1	2414	Saturated	R	°C	-50,0	*	105,0	Saturated T° circuit 1
User		Compressor			Circuit 1	2415	Liquid	R	°C	-50,0	*	105,0	Liquid T° circuit 1
User		Compressor			Circuit 1	2416	Suction	R	°C	-50,0	*	105,0	Suction T° circuit 1
User		Compressor			Circuit 1	2417	Discharge 1	R	°C	-50,0	*	150,0	Discharge T° 1 circuit 1
User		Compressor			Circuit 1	2418	Discharge 2	R	°C	-50,0	*	150,0	Discharge T° 2 circuit 1
User		Compressor		2420	Cir.1 Comp.1	2421	Config	R	*	*	*	*	Configuration compressor 1 circuit 1
User		Compressor			Cir.1 Comp.1	2422	Status	R	*	*	*	*	Status compressor 1 circuit 1
User		Compressor			Cir.1 Comp.1	2423	Sw State	R	*	0	*	1	Input compressor 1 circuit 1
User		Compressor			Cir.1 Comp.1	2424	Output	R	*	0	*	1	Output compressor 1 circuit 1
User		Compressor			Cir.1 Comp.1	2425	Capacity	R	%	0,0	*	100,0	Capacity compressor 1 circuit 1
User		Compressor			Cir.1 Comp.1	2426	Time	R	HH	0	*	99999	Hour counter compressor 1 circuit 1
User		Compressor			Cir.1 Comp.1	2427	Start H	R	*	0	*	999	Start counter high compressor 1 circuit 1 (example : 123)
User		Compressor			Cir.1 Comp.1	2428	Start L	R	*	0	*	999	Start counter low compressor 1 circuit 1 (example 456)

Level 1	Item	Level 2	Item	Level 3	Item	Level 4	Item	R/W/Z	Unit	Min	Std	Max	Description
	User		Compressor	2430	Cir.1 Comp.2	2431	Config	R	*	*	*	*	Configuration compressor 2 circuit 1
	User		Compressor		Cir.1 Comp.2	2432	Status	R	*	*	*	*	Status compressor 2 circuit 1
	User		Compressor		Cir.1 Comp.2	2433	Sw State	R	*	0	*	1	Input compressor 2 circuit 1
	User		Compressor		Cir.1 Comp.2	2434	Output	R	*	0	*	1	Output compressor 2 circuit 1
	User		Compressor		Cir.1 Comp.2	2435	Capacity	R	%	0,0	*	100,0	Capacity compressor 2 circuit 1
	User		Compressor		Cir.1 Comp.2	2436	Time	R	HH	0	*	99999	Hour counter compressor 2 circuit 1
	User		Compressor		Cir.1 Comp.2	2437	Start H	R	*	0	*	999	Start counter high compressor 2 circuit 1 (example : 123)
	User		Compressor		Cir.1 Comp.2	2438	Start L	R	*	0	*	999	Start counter low compressor 2 circuit 1 (example 456)
	User		Compressor	2440	Cir.1 Comp.3	2441	Config	R	*	*	*	*	Configuration compressor 3 circuit 1
	User		Compressor		Cir.1 Comp.3	2442	Status	R	*	*	*	*	Status compressor 3 circuit 1
	User		Compressor		Cir.1 Comp.3	2443	Sw State	R	*	0	*	1	Input compressor 3 circuit 1
	User		Compressor		Cir.1 Comp.3	2444	Output	R	*	0	*	1	Output compressor 3 circuit 1
	User		Compressor		Cir.1 Comp.3	2445	Capacity	R	%	0,0	*	100,0	Capacity compressor 3 circuit 1
	User		Compressor		Cir.1 Comp.3	2446	Time	R	HH	0	*	99999	Hour counter compressor 3 circuit 1
	User		Compressor		Cir.1 Comp.3	2447	Start H	R	*	0	*	999	Start counter high compressor 3 circuit 1 (example : 123)
	User		Compressor		Cir.1 Comp.3	2448	Start L	R	*	0	*	999	Start counter low compressor 3 circuit 1 (example 456)
	User		Compressor	2450	Circuit 2	2451	Condensing	R	Bar	-50,0	*	105,0	Condensing pressure circuit 2
	User		Compressor		Circuit 2	2452	Condensing	R	°C	-50,0	*	105,0	Condensing T° circuit 2
	User		Compressor		Circuit 2	2453	Saturated	R	Bar	-50,0	*	105,0	Saturated pressure circuit 2
	User		Compressor		Circuit 2	2454	Saturated	R	°C	-50,0	*	105,0	Saturated T° circuit 2
	User		Compressor		Circuit 2	2455	Liquid	R	°C	-50,0	*	105,0	Liquid T° circuit 2
	User		Compressor		Circuit 2	2456	Suction	R	°C	-50,0	*	105,0	Suction T° circuit 2
	User		Compressor		Circuit 2	2457	Discharge 1	R	°C	-50,0	*	150,0	Discharge T° 1 circuit 2
	User		Compressor		Circuit 2	2458	Discharge 2	R	°C	-50,0	*	150,0	Discharge T° 2 circuit 2



Level 1	Item	Level 2	Item	Level 3	Item	Level 4	Item	R/W/Z	Unit	Min	Std	Max	Description
	User		Compressor	2460	Cir.2 Comp.1	2461	Config	R	*	*	*	*	Configuration compressor 1 circuit 2
	User		Compressor		Cir.2 Comp.1	2462	Status	R	*	*	*	*	Status compressor 1 circuit 2
	User		Compressor		Cir.2 Comp.1	2463	Sw State	R	*	0	*	1	Input compressor 1 circuit 2
	User		Compressor		Cir.2 Comp.1	2464	Output	R	*	0	*	1	Output compressor 1 circuit 2
	User		Compressor		Cir.2 Comp.1	2465	Capacity	R	%	0,0	*	100,0	Capacity compressor 1 circuit 2
	User		Compressor		Cir.2 Comp.1	2466	Time	R	HH	0	*	99999	Hour counter compressor 1 circuit 2
	User		Compressor		Cir.2 Comp.1	2467	Start H	R	*	0	*	999	Start counter high compressor 1 circuit 2 (example : 123)
	User		Compressor		Cir.2 Comp.1	2468	Start L	R	*	0	*	999	Start counter low compressor 1 circuit 2 (example 456)
	User		Compressor	2470	Cir.2 Comp.2	2471	Config	R	*	*	*	*	Configuration compressor 2 circuit 2
	User		Compressor		Cir.2 Comp.2	2472	Status	R	*	*	*	*	Status compressor 2 circuit 2
	User		Compressor		Cir.2 Comp.2	2473	Sw State	R	*	0	*	1	Input compressor 2 circuit 2
	User		Compressor		Cir.2 Comp.2	2474	Output	R	*	0	*	1	Output compressor 2 circuit 2
	User		Compressor		Cir.2 Comp.2	2475	Capacity	R	%	0,0	*	100,0	Capacity compressor 2 circuit 2
	User		Compressor		Cir.2 Comp.2	2476	Time	R	HH	0	*	99999	Hour counter compressor 2 circuit 2
	User		Compressor		Cir.2 Comp.2	2477	Start H	R	*	0	*	999	Start counter high compressor 2 circuit 2 (example : 123)
	User		Compressor		Cir.2 Comp.2	2478	Start L	R	*	0	*	999	Start counter low compressor 2 circuit 2 (example 456)
	User		Compressor	2480	Cir.2 Comp.3	2481	Config	R	*	*	*	*	Configuration compressor 3 circuit 2
	User		Compressor		Cir.2 Comp.3	2482	Status	R	*	*	*	*	Status compressor 3 circuit 2
	User		Compressor		Cir.2 Comp.3	2483	Sw State	R	*	0	*	1	Input compressor 3 circuit 2
	User		Compressor		Cir.2 Comp.3	2484	Output	R	*	0	*	1	Output compressor 3 circuit 2
	User		Compressor		Cir.2 Comp.3	2485	Capacity	R	%	0,0	*	100,0	Capacity compressor 3 circuit 2
	User		Compressor		Cir.2 Comp.3	2486	Time	R	HH	0	*	99999	Hour counter compressor 3 circuit 2
	User		Compressor		Cir.2 Comp.3	2487	Start H	R	*	0	*	999	Start counter high compressor 3 circuit 2 (example : 123)
	User		Compressor		Cir.2 Comp.3	2488	Start L	R	*	0	*	999	Start counter low compressor 3 circuit 2 (example 456)



Level 1	Item	Level 2	Item	Level 3	Item	Level 4	Item	R/W/Z	Unit	Min	Std	Max	Description
	User		Compressor	2490	Other	2491	Sw HP C1	R	*	0	*	1	Safety pressure switch circuit 1
	User		Compressor		Other	2492	Sw HP C2	R	*	0	*	1	Safety pressure switch circuit 2
	User		Compressor		Other	2493	V4V C1	R	*	0	*	1	Reversing valve circuit 1
	User		Compressor		Other	2494	V4V C2	R	*	0	*	1	Reversing valve circuit 2
	User	2500	Condenser	2510	Circuit 1	2511	Config	R	*	*	*	*	Configuration condenser circuit 1
	User		Condenser		Circuit 1	2512	Status	R	*	*	*	*	Status condenser circuit 1
	User		Condenser		Circuit 1	2513	Sw State	R	*	0	*	1	Input condenser circuit 1
	User		Condenser		Circuit 1	2514	Input	R	°C	-50,0	*	67,0	Condensing T° circuit 1
	User		Condenser		Circuit 1	2515	Setpoint	R	°C	25,0	*	45,0	Condensing T° set point
	User		Condenser		Circuit 1	2516	Capacity	R	%	0,0	*	100,0	Condensing fan capacity circuit 1
	User		Condenser		Circuit 1	2517	Speed Low	R	*	0	*	1	Condensing fan low speed circuit 1
	User		Condenser		Circuit 1	2518	Speed High	R	*	0	*	1	Condensing fan high speed circuit 1
	User		Condenser	2520	Circuit 2	2521	Config	R	*	*	*	*	Configuration condenser circuit 2
	User		Condenser		Circuit 2	2522	Status	R	*	*	*	*	Status condenser circuit 2
	User		Condenser		Circuit 2	2523	Sw State	R	*	0	*	1	Input condenser circuit 2
	User		Condenser		Circuit 2	2524	Input	R	°C	-50,0	*	67,0	Condensing T° circuit 2
	User		Condenser		Circuit 2	2525	Setpoint	R	°C	25,0	*	45,0	Condensing T° set point
	User		Condenser		Circuit 2	2526	Capacity	R	%	0,0	*	100,0	Condensing fan capacity circuit 2
	User		Condenser		Circuit 2	2527	Speed Low	R	*	0	*	1	Condensing fan low speed circuit 2
	User		Condenser		Circuit 2	2528	Speed High	R	*	0	*	1	Condensing fan high speed circuit 2
	User		Condenser	2530	Circuit 1/2	2531	Config	R	*	*	*	*	Configuration condenser circuit 1&2
	User		Condenser		Circuit 1/2	2532	Status	R	*	*	*	*	Status condenser circuit 1&2
	User		Condenser		Circuit 1/2	2533	Sw State	R	*	0	*	1	Input condenser circuit 1&2
	User		Condenser		Circuit 1/2	2534	Capacity	R	%	0,0	*	100,0	Condensing capacity circuit 1&2
	User		Condenser	2540	Fan	2541	Outside	R	°C	-50,0	*	105,0	Outside air T°
	User		Condenser		Fan	2542	Capacity Max	R	%	0,0	*	100,0	Condenser fan capacity maximum
	User		Condenser		Fan	2543	Unloading	R/W	°C	50,0	*	65,0	Condenser unloading T°
	User		Condenser		Fan	2544	Mode	R/WZ	*	0=Not Set, 1=Quiet, 2=Quiet++.			Condenser fan accoustic mode
	User		Condenser		Fan	2545	Noise	R/WZ	dBa	82,0	*	94,0	Condenser fan accoustic noise

Level 1	Item	Level 2	Item	Level 3	Item	Level 4	Item	R/W/Z	Unit	Min	Std	Max	Description
User			Condenser	2550	Water	2551	Inlet C1	R	*	-50,0	*	105,0	Condenser inlet T° circuit 1
User			Condenser		Water	2552	Outlet C1	R	*	-50,0	*	105,0	Condenser outlet T° circuit 1
User			Condenser		Water	2553	Inlet C2	R	*	-50,0	*	105,0	Condenser inlet T° circuit 2
User			Condenser		Water	2554	Outlet C2	R	*	-50,0	*	105,0	Condenser outlet T° circuit 2
User		2600	EEV	2610	Circuit 1	2611	Config	R	*	*	*	*	*
User			EEV		Circuit 1	2612	Status	R	*	*	*	*	*
User			EEV		Circuit 1	2613	Saturated	R	*	*	*	*	*
User			EEV		Circuit 1	2614	Saturated	R	*	*	*	*	*
User			EEV		Circuit 1	2615	Suction	R	*	*	*	*	*
User			EEV		Circuit 1	2616	Superheat	R	*	*	*	*	*
User			EEV		Circuit 1	2617	Capacity	R	*	*	*	*	*
User			EEV		Circuit 1	2618	Step	R	*	*	*	*	*
User			EEV		Circuit 1	2619	Power	R	*	*	*	*	*
User			EEV	2620	Circuit 2	2621	Config	R	*	*	*	*	*
User			EEV		Circuit 2	2622	Status	R	*	*	*	*	*
User			EEV		Circuit 2	2623	Saturated	R	*	*	*	*	*
User			EEV		Circuit 2	2624	Saturated	R	*	*	*	*	*
User			EEV		Circuit 2	2625	Suction	R	*	*	*	*	*
User			EEV		Circuit 2	2626	Superheat	R	*	*	*	*	*
User			EEV		Circuit 2	2627	Capacity	R	*	*	*	*	*
User			EEV		Circuit 2	2628	Step	R	*	*	*	*	*
User			EEV		Circuit 2	2629	Power	R	*	*	*	*	*
User		2700	Other	2710	Freecooling	2711	Config	R	*	*	*	*	Configuration of the freecooling
User			Other		Freecooling	2712	Status	R	*	*	*	*	Status of the freecooling
User			Other		Freecooling	2713	Sw State	R	*	0	*	1	Input of the freecooling
User			Other		Freecooling	2714	Outside	R	°C	-50,0	*	105,0	Outside air T°
User			Other		Freecooling	2715	Inlet	R	°C	-50,0	*	105,0	Inlet coil water T°
User			Other		Freecooling	2716	Outlet	R	°C	-50,0	*	105,0	Outlet coil water T°
User			Other		Freecooling	2717	Capacity	R	%	0,0	*	100,0	Freecooling fan capacity
User			Other		Freecooling	2718	Valve	R	*	0	*	1	Freecooling valve
User			Other	2720	FP Correct	2721	Config	R	*	*	*	*	Configuration of the power factor correction
User			Other		FP Correct	2722	Status	R	*	*	*	*	Status of the power factor correction
User			Other		FP Correct	2723	Sw State	R	*	0	*	1	Input of the power factor correction

Level 1	Item	Level 2	Item	Level 3	Item	Level 4	Item	R/W/Z	Unit	Min	Std	Max	Description
	User		Other	2730	Heater Elec	2731	Config	R	*	*	*	*	Configuration of the electrical heater
	User		Other		Heater Elec	2732	Status	R	*	*	*	*	Status of the electrical heater
	User		Other		Heater Elec	2733	Outlet	R	°C	-50,0	*	105,0	Evaporator outlet T°
	User		Other		Heater Elec	2734	Capacity	R	%	0,0	*	100,0	Electrical heater capacity
	User		Other		Heater Elec	2735	Sw State	R	*	0	*	1	Electrical heater input
	User		Other		Heater Elec	2736	Output 1	R	*	0	*	1	Electrical heater output 1
	User		Other		Heater Elec	2737	Output 2	R	*	0	*	1	Electrical heater output 2
	User		Other		Heater Elec	2738	Output 3	R	*	0	*	1	Electrical heater output 3
	User		Other		Heater Elec	2739	Output 4	R	*	0	*	1	Electrical heater output 4
	User	2800	Link	2810	Master/Slave	2811	Config	R	*	*	*	*	Configuration of the master/slave link
	User		Link		Master/Slave	2812	Status	R	*	*	*	*	Status of the master/slave link
	User		Link		Master/Slave	2813	Id	R	*	1	*	8	Identification number of the BM60 board
	User		Link		Master/Slave	2814	Outside	R	°C	-50,0	*	105,0	Outside air reference T°
	User		Link		Master/Slave	2815	Inlet	R	°C	-50,0	*	105,0	Evaporator inlet reference T°
	User		Link		Master/Slave	2816	Outlet	R	°C	-50,0	*	105,0	Evaporator outlet reference T°
	User		Link		Master/Slave	2817	Priority	R	*	1	*	8	Unit number priority to start
	User		Link		Master/Slave	2818	Standby	R	*	1	*	8	Unit number in standby
	User		Link		Master/Slave	2819	Next Start	R	*	1	*	8	Unit number to start next
	User		Link	2820	BMS	2821	Id	R	*	1	*	99	Identification number of the unit
	User		Link		BMS	2822	Status	R	*	*	*	*	Status of the BMS
	User		Link		BMS	2823	Watchdog	R	*	0	*	32000	Watchdog timer
	User		Link		BMS	2824	Outside	R	°C	-50,0	*	105,0	Outside air BMS T°
	User		Link		BMS	2825	Inlet	R	°C	-50,0	*	105,0	Evaporator inlet BMS T°
	User		Link		BMS	2826	Outlet	R	°C	-50,0	*	105,0	Evaporator outlet BMS T°
	User		Link		BMS	2827	Inoc	R	*	0	*	1	*

Level 1	Item	Level 2	Item	Level 3	Item	Level 4	Item	R/W/Z	Unit	Min	Std	Max	Description
3000	Expert	3100	Unit	3110	General	3111	On/Off	R/W	0	0	*	1	General On/Off
	Expert		Unit		General	3112	Sw On/Off	R/W	0	0	*	1	Remote On/Off
	Expert		Unit		General	3113	Run	R/W/Z	*	0	1	1	Enable
	Expert		Unit		General	3114	Reset Alarm	R/W	*	0	0	1	Reset the active alarm(s)
	Expert		Unit		General	3115	Clear Alarm	R/W	*	0	0	1	Clear the historic of alarm(s)
	Expert		Unit		General	3116	Elec.Box	R	°C	-50,0	*	105,0	Electrical box T°
	Expert		Unit		General	3117	Status	R	*	*	*	*	General status
	Expert		Unit		General	3118	Test	R/W	*	0=Not set, 1=Quickly, 2=Wizard, 3=Daily Task, 4=Weekly Task, 5=Defrost C1, 6=Defrost C2, 7=Defrost C1&2, 8=HP C1, 9=HP C2, 10=HP C1&2.			Test
	Expert		Unit		General	3119	Restore	R/W	*	0=Not set, 1=DC+Bms, 2=Schedule, 3=Factory, 4=Store User, 5=Restore User.			Restore the settings parameters
	Expert		Unit	3120	Configuration	3121	Range	R/W	*	0=Not set, 1=EAC, 2=EAR, 3=NAC, 4=NAH, 5=MWC, 6=NWC, 8=MRC.			Unit range configuration
	Expert		Unit		Configuration	3122	Size	R/W	*	*	*	*	Unit size configuration
	Expert		Unit		Configuration	3123	EEV	R/W	*	*	*	*	Electronique expansion valve configuration
	Expert		Unit		Configuration	3124	Glycol	R/W	%	0	0	50	Glycol rate configuration
	Expert		Unit	3130	Cust.Relay	3131	BM.NO7	R/W	*	0=Not Set, 1=Alarm, 2=Fault, 3=Alarm C1, 4=Alarm C2, 5=Alarm Cond, 6=Alarm Pump Evap, 7=Alarm Flow Evap, 8=Enable, 9=Avaible, 10=Run, 11=Run 100%, 12=Cooling Mode, 13=Heating Mode, 14=Dead Zone Mode, 15=Zone 0, 16=Zone 1, 17=Zone 2, 18=Zone 3, 19=Zone 4, 20=Zone 5, 21=Zone 6, 22=Mode A, 23=Mode B, 24=Mode C, 25=Mode D, 26=Mode BMS, 27=Elec.Heater 1, 28=Elec.Heater 2, 29=Elec.Heater 3, 30=Elec.Heater 4, 31=Free BM.NO7, 32=Free BE.NO1, 33=Free BE.NO2, 34=Free BE.NO3, 35=Free BE.NO4, 36=Not Used, 37=Not Used, 38=Not Used, 39=Not Used, 40=Freecooling, 41=NSR 1, 42=NSR 2, 43=NSR 3, 44=NSR 4, 45=NSR 5.		Configuration of the free output BM.NO7	

Level 1	Item	Level 2	Item	Level 3	Item	Level 4	Item	R/W/Z	Unit	Min	Std	Max	Description
	Expert		Unit		Cust.Relay	3132	BE.NO1	R/W	*	*	*	*	Configuration of the free output BE.NO1
	Expert		Unit		Cust.Relay	3133	BE.NO2	R/W	*	*	*	*	Configuration of the free output BE.NO2
	Expert		Unit		Cust.Relay	3134	BE.NO3	R/W	*	*	*	*	Configuration of the free output BE.NO3
	Expert		Unit		Cust.Relay	3135	BE.NO4	R/W	*	*	*	*	Configuration of the free output BE.NO4
	Expert		Unit	3140	Cust.Switch	3141	BM.Id4	R/W	*	0=Not Set, 1=On/Off, 2=Reset Alarm, 3=Swap 2° SP, 4=Cooling, 5=Heating, 6=Dead Zone, 7=Delay Defrost, 8=Disable C1, 9=Disable C2, 10=Disable C1Cp1, 11=Disable C1Cp2, 12=Disable C1Cp3, 13=Disable C2Cp1, 14=Disable C2Cp2, 15=Disable C2Cp3, 16=Mode A, 17=Mode B, 18=Mode C, 19=Mode D, 20=Mode BMS, 21=Heater Elec., 22=Free BM.Id4, 23=Free BM.Id7, 24=Free BE.Id1, 25=Free BE.Id2, 26=Free BE.Id3, 27=Free BE.Id4, 28=Not Used, 29=Not Used, 30=Not Used, 31=Not Used, 32=Not Used, 33=Freecooling, 34=Corrector FP, 35=NSR 1, 36=NSR 2, 37=NSR 3, 38=NSR 4, 39=NSR 5, 40=NSR 6.			Configuration of the free input BM.Id4
	Expert		Unit		Cust.Switch	3142	BM.Id7	R/W	*	*	*	*	Configuration of the free input BM.Id7
	Expert		Unit		Cust.Switch	3143	BE.Id1	R/W	*	*	*	*	Configuration of the free input BE.Id1
	Expert		Unit		Cust.Switch	3144	BE.Id2	R/W	*	*	*	*	Configuration of the free input BE.Id2
	Expert		Unit		Cust.Switch	3145	BE.Id3	R/W	*	*	*	*	Configuration of the free input BE.Id3
	Expert		Unit		Cust.Switch	3146	BE.Id4	R/W	*	*	*	*	Configuration of the free input BE.Id4
	Expert		Unit	3150	Cust.Signal	3151	BE.B1	R/W	*	0=Not Set, 1=Water Sp, 2=Offset Sp, 3=Free BE.B1, 4=Free BE.B2, 5=Free BE.B3, 6=Free BE.B4, 7=Discharge 1, 8=Discharge 2, 9=Discharge 3, 10=Discharge 4, 11=Condensor Inlet, 12=Condensor Outlet, 13=Freecooling Inlet, 14=Recovery Inlet, 15=Recovery Outlet, 16=NSR 1, 17=NSR 2, 18=NSR 3, 19=NSR 4.			Configuration of the free input BE.B1
	Expert		Unit		Cust.Signal	3152	BE.B2	R/W	*	*	*	*	Configuration of the free input BE.B2
	Expert		Unit		Cust.Signal	3153	BE.B3	R/W	*	*	*	*	Configuration of the free input BE.B3
	Expert		Unit		Cust.Signal	3154	BE.B4	R/W	*	*	*	*	Configuration of the free input BE.B4



Level 1	Item	Level 2	Item	Level 3	Item	Level 4	Item	R/W/Z	Unit	Min	Std	Max	Description
	Expert		Unit	3160	Option	3161	Pump Cool	R/W	*	0=Not Set, 1=Single= 2=Single%,	3=Double= 4=Double%.		Evaporator pump(s) configuration
	Expert		Unit		Option	3162	Pump Heat	R/W	*	0=Not Set, 1=Single= 2=Single%,	3=Double= 4=Double%.		Condenser pump(s) configuration
	Expert		Unit		Option	3163	FP Cos	R/W	*	0=No, 1=Yes.			Power factor correction configuration
	Expert		Unit		Option	3164	Freecooling	R/W	*	0=No, 1=Yes.			Freecooling configuration
	Expert		Unit		Option	3165	Power meter	R/W	*	0=Not Set, 1=1,.,.,, 2=.,2.,.,, 3=1,2,.,.			Power meter configuration
	Expert		Unit		Option	3166	Heater Elec	R/W	*	0=No, 1=Yes.			Electrical heater configuration
	Expert		Unit		Option	3167	Remote DC	R/W	*	0=No, 1=Yes.			Remote DC60 configuration
	Expert	3200	Water	3210	Temperature	3211	Inlet	R	°C	-50,0	*	105,0	Evaporator inlet probe T°
	Expert		Water		Temperature	3212	Inlet Ref	R	°C	-50,0	*	105,0	Evaporator inlet reference T°
	Expert		Water		Temperature	3213	Outlet	R	°C	-50,0	*	105,0	Evaporator outlet probe T°
	Expert		Water		Temperature	3214	Outlet Ref	R	°C	-50,0	*	105,0	Evaporator outlet reference T°
	Expert		Water		Temperature	3215	Delta T°	R	°C	-50,0	*	105,0	Evaporator delta T° (Inlet- Outlet)
	Expert		Water		Temperature	3216	Setpoint	R	°C	-50,0	*	105,0	Evaporator set point
	Expert		Water		Temperature	3217	Capacity	R	%	-50,0	*	105,0	Evaporator capacity
	Expert		Water		Temperature	3218	Flow	R	*	0	*	1	Evaporator flow switch
	Expert		Water	3220	Changeover	3221	Status	R	*	*	*	*	Changeover status
	Expert		Water		Changeover	3222	Outside	R	°C	-50,0	*	105,0	Outside air probe T°
	Expert		Water		Changeover	3223	Outside Ref	R	°C	-50,0	*	105,0	Outside air reference T°
	Expert		Water		Changeover	3224	Mode	R/W/Z	*	0=Not Used, 1=Cool, 2=Heat,	3=Auto, 4=Dead zone.		Changeover mode
	Expert		Water		Changeover	3225	Winter	R/W	°C	-10,0	18,0	30,0	Winter T° to swap in heating mode
	Expert		Water		Changeover	3226	Summer	R/W	°C	19,0	23,0	30,0	Summer T° to swap in cooling mode

Level 1	Item	Level 2	Item	Level 3	Item	Level 4	Item	R/W/Z	Unit	Min	Std	Max	Description
	Expert		Water	3230	Cooling	3231	Status	R	*	*	*	*	Evaporator status
	Expert		Water		Cooling	3232	Inlet	R	°C	-50,0	*	105,0	Evaporator inlet reference T°
	Expert		Water		Cooling	3233	Outlet	R	°C	-50,0	*	105,0	Evaporator outlet reference T°
	Expert		Water		Cooling	3234	Setpoint	R	°C	-50,0	*	105,0	Evaporator set point
	Expert		Water		Cooling	3235	Capacity	R	%	0,0	*	100,0	Evaporator cooling capacity
	Expert		Water		Cooling	3236	Air 1	R/W/Z	°C	-11,0	22,0	50,0	Outside air set point X1 in cool
	Expert		Water		Cooling	3237	Air 2	R/W/Z	°C	-11,0	30,0	50,0	Outside air set point X2 in cool
	Expert		Water		Cooling	3238	Water 1	R/W/Z	°C	19,0	7,0	20,0	Evaporator set point X1 in cool
	Expert		Water		Cooling	3239	Water 2	R/W/Z	°C	19,0	7,0	20,0	Evaporator set point X2 in cool
	Expert		Water	3240	Heating	3241	Status	R	*	*	*	*	Evaporator status
	Expert		Water		Heating	3242	Inlet	R	°C	-50,0	*	105,0	Evaporator inlet reference T°
	Expert		Water		Heating	3243	Outlet	R	°C	-50,0	*	105,0	Evaporator outlet reference T°
	Expert		Water		Heating	3244	Setpoint	R	°C	-50,0	*	105,0	Evaporator set point
	Expert		Water		Heating	3245	Capacity	R	%	0,0	*	100,0	Evaporator cooling capacity
	Expert		Water		Heating	3246	Air 1	R/W/Z	°C	-11,0	22,0	50,0	Outside air set point X1 in heat
	Expert		Water		Heating	3247	Air 2	R/W/Z	°C	-11,0	30,0	50,0	Outside air set point X2 in heat
	Expert		Water		Heating	3248	Water 1	R/W/Z	°C	40,0	45,0	50,0	Evaporator set point X1 in heat
	Expert		Water		Heating	3249	Water 2	R/W/Z	°C	40,0	45,0	50,0	Evaporator set point X2 in heat
	Expert		Water	3250	Custom	3251	Sp 4/20mA	R	°C	4,0	*	20,0	External evaporator set point
	Expert		Water		Custom	3252	Sp +/-0.5°C	R	°C	-0,5	*	0,5	External offset evaporator set point
	Expert		Water		Custom	3253	2nd Sp	R	*	0	*	1	Second set point switch status
	Expert		Water	3260	Control	3261	Cool dT°	R/W	°C	1,0	5,0	20,0	Evaporator cooling delta T°
	Expert		Water		Control	3262	Heat dT°	R/W	°C	1,0	5,0	20,0	Evaporator heating delta T°
	Expert		Water		Control	3263	Reactivity	R/W	*	1	30	120	Evaporator water reactivity
	Expert		Water	3270	Safety	3271	Cool Low	R/W	°C	3,0	5,0	55,0	Evaporator cooling low safety T°
	Expert		Water		Safety	3272	Cool High	R/W	°C	19,0	55,0	55,0	Evaporator cooling high safety T°
	Expert		Water		Safety	3273	Heat Low	R/W	°C	3,0	5,0	55,0	Evaporator heating low safety T°
	Expert		Water		Safety	3274	Heat High	R/W	°C	19,0	55,0	55,0	Evaporator heating high safety T°

Level 1	Item	Level 2	Item	Level 3	Item	Level 4	Item	R/W/Z	Unit	Min	Std	Max	Description
	Expert	3300	Pump	3310	Cooling P1	3311	Status	R	*	*	*	*	Evaporator pump 1 status
	Expert		Pump		Cooling P1	3312	Sw State	R	*	0	*	1	Evaporator pump 1 input
	Expert		Pump		Cooling P1	3313	Output	R	*	0	*	1	Evaporator pump 1 output
	Expert		Pump		Cooling P1	3314	Hour	R	HH	0	*	99999	Evaporator pump 1 output
	Expert		Pump		Cooling P1	3315	Flow	R	*	0,0	*	100,0	Evaporator flow switch
	Expert		Pump	3320	Cooling P2	3321	Status	R	*	*	*	*	Evaporator pump 2 status
	Expert		Pump		Cooling P2	3322	Sw State	R	*	0	*	1	Evaporator pump 2 input
	Expert		Pump		Cooling P2	3323	Output	R	*	0	*	1	Evaporator pump 2 output
	Expert		Pump		Cooling P2	3324	Hour	R	HH	0	*	99999	Evaporator pump 2 output
	Expert		Pump		Cooling P2	3325	Flow	R	*	0,0	*	100,0	Evaporator flow switch
	Expert		Pump	3330	Heating P1	3331	Status	R	*	*	*	*	Condenser pump 1 status
	Expert		Pump		Heating P1	3332	Sw State	R	*	0	*	1	Condenser pump 1 input
	Expert		Pump		Heating P1	3333	Output	R	*	0	*	1	Condenser pump 1 output
	Expert		Pump		Heating P1	3334	Hour	R	HH	0	*	99999	Condenser pump 1 output
	Expert		Pump		Heating P1	3335	Flow	R	*	0,0	*	100,0	Condenser flow switch
	Expert		Pump	3340	Heating P2	3341	Status	R	*	*	*	*	Condenser pump 2 status
	Expert		Pump		Heating P2	3342	Sw State	R	*	0	*	1	Condenser pump 2 input
	Expert		Pump		Heating P2	3343	Output	R	*	0	*	1	Condenser pump 2 output
	Expert		Pump		Heating P2	3344	Hour	R	HH	0	*	99999	Condenser pump 2 output
	Expert		Pump		Heating P2	3345	Flow	R	*	0,0	*	100,0	Condenser flow switch
	Expert		Pump	3350	Cooling Flow	3351	T.In	R	°C	-50,0	*	105,0	Evaporator T° inlet
	Expert		Pump		Cooling Flow	3352	T.Out	R	°C	-50,0	*	105,0	Evaporator T° outlet
	Expert		Pump		Cooling Flow	3353	P.In	R	Bar	0,0	*	6,0	Evaporator pressure in
	Expert		Pump		Cooling Flow	3354	P.Out	R	Bar	0,0	*	6,0	Evaporator pressure out
	Expert		Pump		Cooling Flow	3355	Delta dT	R	°C	0,0	*	20,0	Evaporator delta T°
	Expert		Pump		Cooling Flow	3356	Delta dP	R	Bar	0,0	*	6,0	Evaporator delta pressure
	Expert		Pump		Cooling Flow	3357	Capacity	R	%	0,0	*	100,0	Evaporator flow capacity
	Expert		Pump		Cooling Flow	3358	Flow	R	m3	0,0	*	100,0	Evaporator flow meter
	Expert		Pump		Cooling Flow	3359	Flow	R	*	0	*	1	Evaporator flow switch



Level 1	Item	Level 2	Item	Level 3	Item	Level 4	Item	R/W/Z	Unit	Min	Std	Max	Description
	Expert		Pump	3360	Heating Flow	3361	T.In	R	°C	-50,0	*	105,0	Condenser T° inlet
	Expert		Pump		Heating Flow	3362	T.Out	R	°C	-50,0	*	105,0	Condenser T° outlet
	Expert		Pump		Heating Flow	3363	P.In	R	Bar	0,0	*	6,0	Condenser pressure in
	Expert		Pump		Heating Flow	3364	P.Out	R	Bar	0,0	*	6,0	Condenser pressure out
	Expert		Pump		Heating Flow	3365	Delta dT	R	°C	0,0	*	20,0	Condenser delta T°
	Expert		Pump		Heating Flow	3366	Delta dP	R	Bar	0,0	*	6,0	Condenser delta pressure
	Expert		Pump		Heating Flow	3367	Capacity	R	%	0,0	*	100,0	Condenser flow capacity
	Expert		Pump		Heating Flow	3368	Flow	R	m3	0,0	*	100,0	Condenser flow meter
	Expert		Pump		Heating Flow	3369	Flow	R	*	0	*	1	Condenser flow switch
	Expert		Pump	3370	Cooling Control	3371	Enable	R/W/Z	*	0=Not Set, 1=Not Used, 2=Prio.P1On, 3=Prio.P1Auto,	4=Prio.P2On, 5=Prio.P2Auto, 6=No Prio.On, 7=No Prio.Auto.		Evaporator pump(s) enable
	Expert		Pump		Cooling Control	3372	Mode	R/W	*	0=Not Used, 1=Fix Speed, 2=Fix dT,	3=Fix dP, 4=Fix P.Out.		Evaporator pump(s) operating mode
	Expert		Pump		Cooling Control	3373	Reset	R/W	*	0=Not Set, 1=1,..., 2=.,2,..			Evaporator pump(s) reset counter
	Expert		Pump		Cooling Control	3374	Delta dT	R/W	°C	2,0	*	10,0	Evaporator variable flow delta T°
	Expert		Pump		Cooling Control	3375	Delta dP	R/W	Bar	1,0	1,0	2,0	Evaporator variable flow delta pressure
	Expert		Pump		Cooling Control	3376	P.Out	R/W	Bar	0,5	1,0	2,0	Evaporator variable flow output pressure
	Expert		Pump		Cooling Control	3377	Flow Min	R/W	%	60,0	60,0	100,0	Evaporator variable flow minimum
	Expert		Pump		Cooling Control	3378	Flow Max	R/W	%	60,0	100,0	100,0	Evaporator variable flow maximum
	Expert		Pump	3380	Heating Control	3381	Enable	R/W/Z	*	0=Not Set, 1=Not Used, 2=Prio.P1On, 3=Prio.P1Auto,	4=Prio.P2On, 5=Prio.P2Auto, 6=No Prio.On, 7=No Prio.Auto.		condenser pump(s) enable
	Expert		Pump		Heating Control	3382	Mode	R/W	*	0=Not Used, 1=Fix Speed, 2=Fix dT,	3=Fix dP, 4=Fix P.Out.		condenser pump(s) operating mode
	Expert		Pump		Heating Control	3383	Reset	R/W	*	0=Not Set, 1=1,..., 2=.,2,..			condenser pump(s) reset counter
	Expert		Pump		Heating Control	3384	Delta dT	R/W	°C	2,0	*	10,0	condenser variable flow delta T°
	Expert		Pump		Heating Control	3385	Delta dP	R/W	Bar	1,0	1,0	2,0	condenser variable flow delta pressure
	Expert		Pump		Heating Control	3386	P.Out	R/W	Bar	0,5	1,0	2,0	condenser variable flow output pressure
	Expert		Pump		Heating Control	3387	Flow Min	R/W	%	60,0	60,0	100,0	condenser variable flow minimum
	Expert		Pump		Heating Control	3388	Flow Max	R/W	%	60,0	100,0	100,0	condenser variable flow maximum

Level 1	Item	Level 2	Item	Level 3	Item	Level 4	Item	R/W/Z	Unit	Min	Std	Max	Description
	Expert	3400	Compressor	3410	Circuit 1	3411	Condensing	R	Bar	-50,0	*	105,0	Condensing pressure circuit 1
	Expert		Compressor		Circuit 1	3412	Condensing	R	°C	-50,0	*	105,0	Condensing T° circuit 1
	Expert		Compressor		Circuit 1	3413	Saturated	R	Bar	-50,0	*	105,0	Saturated pressure circuit 1
	Expert		Compressor		Circuit 1	3414	Saturated	R	°C	-50,0	*	105,0	Saturated T° circuit 1
	Expert		Compressor		Circuit 1	3415	Liquid	R	°C	-50,0	*	105,0	Liquid T° circuit 1
	Expert		Compressor		Circuit 1	3416	Suction	R	°C	-50,0	*	105,0	Suction T° circuit 1
	Expert		Compressor		Circuit 1	3417	Discharge 1	R	°C	-50,0	*	150,0	Discharge T° 1 circuit 1
	Expert		Compressor		Circuit 1	3418	Discharge 2	R	°C	-50,0	*	150,0	Discharge T° 2 circuit 1
	Expert		Compressor	3420	Circuit 2	3421	Condensing	R	Bar	-50,0	*	105,0	Condensing pressure circuit 2
	Expert		Compressor		Circuit 2	3422	Condensing	R	°C	-50,0	*	105,0	Condensing T° circuit 2
	Expert		Compressor		Circuit 2	3423	Saturated	R	Bar	-50,0	*	105,0	Saturated pressure circuit 2
	Expert		Compressor		Circuit 2	3424	Saturated	R	°C	-50,0	*	105,0	Saturated T° circuit 2
	Expert		Compressor		Circuit 2	3425	Liquid	R	°C	-50,0	*	105,0	Liquid T° circuit 2
	Expert		Compressor		Circuit 2	3426	Suction	R	°C	-50,0	*	105,0	Suction T° circuit 2
	Expert		Compressor		Circuit 2	3427	Discharge 1	R	°C	-50,0	*	150,0	Discharge T° 1 circuit 2
	Expert		Compressor		Circuit 2	3428	Discharge 2	R	°C	-50,0	*	150,0	Discharge T° 2 circuit 2
	Expert		Compressor	3430	Enable	3431	Enable C1	R/W/Z	*	0=Not Set, 1=1,...., 2=.,2.,, 3=1,2,.., 4=...,3, 5=1,..,3, 6=.,2,3, 7=1,2,3.			Compressor(s) enable circuit 1
	Expert		Compressor		Enable	3432	Enable C2	R/W/Z	*	0=Not Set, 1=1,...., 2=.,2.,, 3=1,2,.., 4=...,3, 5=1,..,3, 6=.,2,3, 7=1,2,3.			Compressor(s) enable circuit 2
	Expert		Compressor		Enable	3433	Reset C1	R/W	*	0=Not Set, 1=1,...., 2=.,2.,, 3=1,2,.., 4=...,3, 5=1,..,3, 6=.,2,3, 7=1,2,3.			Compressor(s) reset counter circuit 1
	Expert		Compressor		Enable	3434	Reset C2	R/W	*	0=Not Set, 1=1,...., 2=.,2.,, 3=1,2,.., 4=...,3, 5=1,..,3, 6=.,2,3, 7=1,2,3.			Compressor(s) reset counter circuit 2
	Expert		Compressor		Enable	3435	Priority	R/W	*	0=Not Used, 1=Prio. C1, 2=Prio. C2, 3=Auto.			Compressor(s) circuit priority
	Expert		Compressor	3440	Safety	3441	Saturation	R/W	°C	-6,0	-6,0	5,0	Evaporator saturation safety T°
	Expert		Compressor		Safety	3442	Unloading	R/W	°C	50,0	63,0	65,0	Condenser unloading safety T°
	Expert		Compressor		Safety	3443	Discharge	R/W	°C	90,0	110,0	150,0	Compressor discharge safety T°

Level 1	Item	Level 2	Item	Level 3	Item	Level 4	Item	R/W/Z	Unit	Min	Std	Max	Description
	Expert	3500	Condenser	3510	Circuit 1	3511	Config	R	*	*	*	*	Configuration condenser circuit 1
	Expert		Condenser		Circuit 1	3512	Status	R	*	*	*	*	Status condenser circuit 1
	Expert		Condenser		Circuit 1	3513	Sw State	R	*	0	*	1	Input condenser circuit 1
	Expert		Condenser		Circuit 1	3514	Input	R	°C	-50,0	*	67,0	Condensing T° circuit 1
	Expert		Condenser		Circuit 1	3515	Setpoint	R	°C	25,0	*	45,0	Condensing T° set point
	Expert		Condenser		Circuit 1	3516	Capacity	R	%	0,0	*	100,0	Condensing fan capacity circuit 1
	Expert		Condenser		Circuit 1	3517	Speed Low	R	*	0	*	1	Condensing fan low speed circuit 1
	Expert		Condenser		Circuit 1	3518	Speed High	R	*	0	*	1	Condensing fan high speed circuit 1
	Expert		Condenser	3520	Circuit 2	3521	Config	R	*	*	*	*	Configuration condenser circuit 2
	Expert		Condenser		Circuit 2	3522	Status	R	*	*	*	*	Status condenser circuit 2
	Expert		Condenser		Circuit 2	3523	Sw State	R	*	0	*	1	Input condenser circuit 2
	Expert		Condenser		Circuit 2	3524	Input	R	°C	-50,0	*	67,0	Condensing T° circuit 2
	Expert		Condenser		Circuit 2	3525	Setpoint	R	°C	25,0	*	45,0	Condensing T° set point
	Expert		Condenser		Circuit 2	3526	Capacity	R	%	0,0	*	100,0	Condensing fan capacity circuit 2
	Expert		Condenser		Circuit 2	3527	Speed Low	R	*	0	*	1	Condensing fan low speed circuit 2
	Expert		Condenser		Circuit 2	3528	Speed High	R	*	0	*	1	Condensing fan high speed circuit 2
	Expert		Condenser	3530	Circuit 1/2	3531	Config	R	*	*	*	*	Configuration condenser circuit 1&2
	Expert		Condenser		Circuit 1/2	3532	Status	R	*	*	*	*	Status condenser circuit 1&2
	Expert		Condenser		Circuit 1/2	3533	Sw State	R	*	0	*	1	Input condenser circuit 1&2
	Expert		Condenser		Circuit 1/2	3534	Input	R	°C	0,0	*	100,0	Condensing capacity circuit 1&2
	Expert		Condenser		Circuit 1/2	3535	Setpoint	R	°C	*	*	*	*
	Expert		Condenser		Circuit 1/2	3536	Capacity	R	%	*	*	*	*
	Expert		Condenser	3540	Fan	3541	Outside	R	°C	-50,0	*	105,0	Outside air T°
	Expert		Condenser		Fan	3542	Capacity Max	R	%	0,0	*	100,0	Condenser fan capacity maximum
	Expert		Condenser		Fan	3543	Unloading	R	°C	50,0	*	65,0	Condenser unloading T°
	Expert		Condenser		Fan	3544	Mode	R/W	*	0=Not Set, 1=Quiet, 2=Quiet++.			Condenser fan acoustic mode
	Expert		Condenser		Fan	3545	Noise	R/W	dBa	82,0	*	94,0	Condenser fan acoustic noise
	Expert		Condenser		Fan	3546	Setpoint	R/W	°C	35,0	40,0	45,0	Condenser fan set point

Level 1	Item	Level 2	Item	Level 3	Item	Level 4	Item	R/W/Z	Unit	Min	Std	Max	Description
	Expert		Condenser	3550	Water	3551	Inlet C1	R	°C	-50,0	*	105,0	Condenser inlet T° circuit 1
	Expert		Condenser		Water	3552	Outlet C1	R	°C	-50,0	*	105,0	Condenser outlet T° circuit 1
	Expert		Condenser		Water	3553	Inlet C2	R	°C	-50,0	*	105,0	Condenser inlet T° circuit 2
	Expert		Condenser		Water	3554	Outlet C2	R	°C	-50,0	*	105,0	Condenser outlet T° circuit 2
	Expert		Condenser	3560	Defrost	3561	Mode	R	*	0=Cyclic, 1=Dynamic.			Defrost mode
	Expert		Condenser		Defrost	3562	T°Outside	R	°C	8,0	16,0	22,0	Outside air defrost T°
	Expert		Condenser		Defrost	3563	Saturation	R	°C	-10,0	1,7	10,0	Evaporator saturation defrost T°
	Expert		Condenser		Defrost	3564	Freq	R	mm	30	45	90	Defrost frequency delay
	Expert		Condenser		Defrost	3565	dLP C1	R/W	°C	-50,0	*	105,0	*
	Expert		Condenser		Defrost	3566	dLP C2	R/W	°C	-50,0	*	105,0	*
	Expert		Condenser		Defrost	3567	Counter C1	R/W	*	30	*	90	*
	Expert		Condenser		Defrost	3568	Counter C2	R/W	*	30	*	90	*
	Expert		Condenser	3570	Safety	3571	Safety Low	R/W	°C	3,0	5,0	55,0	Condenser low safety T°
	Expert		Condenser		Safety	3572	Safety High	R/W	°C	19,0	55,0	55,0	Condenser high safety T°
	Expert	3600	EEV	3610	Circuit 1	3611	Config	R	*	*	*	*	*
	Expert		EEV		Circuit 1	3612	Status	R	*	*	*	*	*
	Expert		EEV		Circuit 1	3613	Saturated	R	*	*	*	*	*
	Expert		EEV		Circuit 1	3614	Saturated	R	*	*	*	*	*
	Expert		EEV		Circuit 1	3615	Suction	R	*	*	*	*	*
	Expert		EEV		Circuit 1	3616	Superheat	R	*	*	*	*	*
	Expert		EEV		Circuit 1	3617	Capacity	R	*	*	*	*	*
	Expert		EEV		Circuit 1	3618	Step	R	*	*	*	*	*
	Expert		EEV		Circuit 1	3619	Power	R	*	*	*	*	*
	Expert		EEV	3620	Circuit 2	3621	Config	R	*	*	*	*	*
	Expert		EEV		Circuit 2	3622	Status	R	*	*	*	*	*
	Expert		EEV		Circuit 2	3623	Saturated	R	*	*	*	*	*
	Expert		EEV		Circuit 2	3624	Saturated	R	*	*	*	*	*
	Expert		EEV		Circuit 2	3625	Suction	R	*	*	*	*	*
	Expert		EEV		Circuit 2	3626	Superheat	R	*	*	*	*	*
	Expert		EEV		Circuit 2	3627	Capacity	R	*	*	*	*	*
	Expert		EEV		Circuit 2	3628	Step	R	*	*	*	*	*
	Expert		EEV		Circuit 2	3629	Power	R	*	*	*	*	*

Level 1	Item	Level 2	Item	Level 3	Item	Level 4	Item	R/W/Z	Unit	Min	Std	Max	Description
	Expert		EEV	3630	Control	3631	Superheat	R/W	*	*	*	*	*
	Expert	3700	Other	3710	Freecooling	3711	Config	R	*	*	*	*	Configuration of the freecooling
	Expert		Other		Freecooling	3712	Status	R	*	*	*	*	Status of the freecooling
	Expert		Other		Freecooling	3713	Sw State	R	*	0	*	1	Input of the freecooling
	Expert		Other		Freecooling	3714	Outside	R	°C	-50,0	*	105,0	Outside air T°
	Expert		Other		Freecooling	3715	Inlet	R	°C	-50,0	*	105,0	Inlet coil water T°
	Expert		Other		Freecooling	3716	Outlet	R	°C	-50,0	*	105,0	Outlet coil water T°
	Expert		Other		Freecooling	3717	Capacity	R	%	0,0	*	100,0	Freecooling fan capacity
	Expert		Other		Freecooling	3718	Valve	R	*	0	*	1	Freecooling valve
	Expert		Other	3720	FP Correct	3721	Config	R	*	*	*	*	Configuration of the power factor correction
	Expert		Other		FP Correct	3722	Status	R	*	*	*	*	Status of the power factor correction
	Expert		Other		FP Correct	3723	Sw State	R	*	0	*	1	Input of the power factor correction
	Expert		Other	3730	Heater Elec	3731	Config	R	*	*	*	*	Configuration of the electrical heater
	Expert		Other		Heater Elec	3732	Status	R	*	*	*	*	Status of the electrical heater
	Expert		Other		Heater Elec	3733	Outlet	R	°C	-50,0	*	105,0	Evaporator outlet T°
	Expert		Other		Heater Elec	3734	Capacity	R	%	0,0	*	100,0	Electrical heater capacity
	Expert		Other		Heater Elec	3735	Sw State	R	*	0	*	1	Electrical heater input
	Expert		Other		Heater Elec	3736	Output 1	R	*	0	*	1	Electrical heater output 1
	Expert		Other		Heater Elec	3737	Output 2	R	*	0	*	1	Electrical heater output 2
	Expert		Other		Heater Elec	3738	Output 3	R	*	0	*	1	Electrical heater output 3
	Expert		Other		Heater Elec	3739	Output 4	R	*	0	*	1	Electrical heater output 4
	Expert	3800	Link	3810	Master/Slave	3811	Status	R	*	*	*	*	Status of the master/slave link
	Expert		Link		Master/Slave	3812	Outside	R	°C	-50,0	*	105,0	Outside air reference T°
	Expert		Link		Master/Slave	3813	Inlet	R	°C	-50,0	*	105,0	Evaporator inlet reference T°
	Expert		Link		Master/Slave	3814	Outlet	R	°C	-50,0	*	105,0	Evaporator outlet reference T°
	Expert		Link		Master/Slave	3815	Number	R/W	*	1	*	8	Number of units linked
	Expert		Link		Master/Slave	3816	Type	R/W	*	0=Not Set, 1=Not Used, 2=CascadTwins, 3=CascadChain, 4=BackupTwins, 5=BackupChain, 6=RoIBackupTwins, 7=RoIBackupChain.			Master/slave configuration
	Expert		Link		Master/Slave	3817	T°Air	R/W	*	0=Not Used, 1=Master, 2=Average.			Outside air T° configuration
	Expert		Link		Master/Slave	3818	T°Water	R/W	*	0=Not Used, 1=Master, 2=Average.			Evaporator water T° configuration



Level 1	Item	Level 2	Item	Level 3	Item	Level 4	Item	R/W/Z	Unit	Min	Std	Max	Description
	Expert		Link	3820	BMS	3821	Status	R	*	*	*	*	Status of the BMS
	Expert		Link		BMS	3822	Outside	R	°C	-50,0	*	105,0	Outside air BMS T°
	Expert		Link		BMS	3823	Inlet	R	°C	-50,0	*	105,0	Evaporator inlet BMS T°
	Expert		Link		BMS	3824	Outlet	R	°C	-50,0	*	105,0	Evaporator outlet BMS T°
	Expert		Link		BMS	3825	Watchdog	R/W	*	0	*	32000	Watchdog timer
	Expert		Link		BMS	3826	Id	R/W	*	1	*	199	Identification number configuration
	Expert		Link		BMS	3827	Protocol	R/W	*	0=Adalink, 1=Lnx Vision, 2=Modbus, 3=Trend,	4=Carel, 5=Bacnet, 6=Lon works.		BMS protocol configuration
	Expert		Link		BMS	3828	Bauderate	R/W	*	0=1200, 1=2400, 2=4800, 3=9600, 4=19200.			BMS bauderate configuration
	Expert		Link		BMS	3829	Inoc	R/W	*	0	*	1	*

**27 - ALARMS**

CODE	DESCRIPTION
1	Water Evaporator,Flow Switch,Cut Off
2	Water Condenser,Flow Switch,Cut Off
7	Buffer Tank,Water Level,Low
8	Buffer Tank,Water Level,High
9	Unit,Power Supply,Electrical Failure
10	Unit,Electrical Heater,Electrical Failure
21	Water Evaporator,Water T°,Outlet Too High
22	Water Evaporator,Water T°,Outlet Too Low
23	Water Evaporator,Water T°,Inlet Too High
24	Water Evaporator,Water T°,Inlet Too Low
25	Water Condenser,Water T°,Outlet Too High
26	Water Condenser,Water T°,Outlet Too Low
27	Water Condenser,Water T°,Inlet Too High
28	Water Condenser,Water T°,Inlet Too Low
34	Electrical Box T°,Air T°,Too High
40	Pump Evaporator,Flow Switch,Cut Off
41	Pump Evaporator,Pump N° 1,Electrical Failure
42	Pump Evaporator,Pump N° 2,Electrical Failure
43	Pump Condenser,Pump N° 1,Electrical Failure
44	Pump Condenser,Pump N° 2,Electrical Failure
45	Pump Evaporator,In Pressure ,Faulty Sensor
46	Pump Evaporator,OUT Pressure ,Faulty Sensor
47	Pump Condenser,In Pressure ,Faulty Sensor
48	Pump Condenser,OUT Pressure ,Faulty Sensor
49	Pump Evaporator,Inverter,Electrical Failure
50	Pump Condenser,Inverter,Electrical Failure
54	Freecooling Fan,Inverter,Electrical Failure
58	Recovery,Water Inlet T°,Faulty Probe
59	Recovery,Water Outlet T°,Faulty Probe
61	Master/Slave,BM Master,Failure Link
62	Master/Slave,BM Slave 2,Failure Link
63	Master/Slave,BM Slave 3,Failure Link
64	Master/Slave,BM Slave 4,Failure Link
65	Master/Slave,BM Slave 5,Failure Link
66	Master/Slave,BM Slave 6,Failure Link
67	Master/Slave,BM Slave 7,Failure Link
68	Master/Slave,BM Slave 8,Failure Link
70	BM board,Real Time Clock,Failure
71	BE Board,BE N°1,Failure Link
72	BE Board,BE N°2,Failure Link
73	Pump Evaporator,Inverter,Failure Link
74	Pump Condenser,Inverter,Failure Link
75	Condenser Fan,Inverter Circuit 1,Failure Link
76	Condenser Fan,Inverter Circuit 2,Failure Link

CODE	DESCRIPTION
77	Condenser Fan, Inverter Circuit 1/2, Failure Link
78	Freecooling Fan, Inverter, Failure Link
79	DC Display, DC60 N°1, Failure Link
80	DC Display, DC60 N°2, Failure Link
81	Water Evaporator, Water Inlet T°, Faulty Probe
83	Outside, Air T°, Faulty Probe
85	Water Evaporator, Water Outlet T°, Faulty Probe
89	Electrical Box T°, Air T°, Faulty Probe
90	Water Freecooling, Inlet T°, Faulty Probe
102	Circuit 1, Fan Condenser Motor, Electrical Failure
103	Circuit 1, Fan Condenser Inverter, Electrical Failure
104	Circuit 1/2, Fan Condenser Motor, Electrical Failure
105	Circuit 1/2, Fan Condenser Inverter, Electrical Failure
108	Unit, Power Factor CosPhi, Electrical Failure
110	Circuit 1, Leak Refrigerant, Detection
111	Circuit 1 Compressor 1, Discharge T°, Overheating
112	Circuit 1, Discharge T° Compressor 2, Overheating
113	Circuit 1, Discharge T° Compressor 3, Overheating
114	Circuit 1, Compressor(s), Electrical Failure
115	Circuit 1, Safety High Pressure, Cut Off
116	Circuit 1, Reversing Valve, Blocked
117	Circuit 1, LOP, Low Operating Pressure
118	Circuit 1, Water Evaporator, Risk Of Frosting
121	Circuit 1, Evaporator Superheat, Too High
122	Circuit 1, Evaporator Superheat, Too Low
123	Circuit 1, Condenser Subcooling, Too High
124	Circuit 1, Condenser Subcooling, Too Low
127	Circuit 1, MOP, Maximum Operating Pressure
129	Circuit 1, Condenser T°, Too High
131	Circuit 1, EEV Valve, Not Closed
132	Circuit 1, EEV Motor, Failure
141	Circuit 1, High Pressure, Faulty Sensor
142	Circuit 1, Low Pressure, Faulty Sensor
143	Circuit 1, Liquid T°, Faulty Probe
144	Circuit 1, Suction T°, Faulty Probe
145	Circuit 1, Discharge T° Compressor 1, Faulty Probe
146	Circuit 1, Discharge T° Compressor 2, Faulty Probe
147	Circuit 1, Discharge T° Compressor 3, Faulty Probe
148	Circuit 1, Water Condenser Inlet T°, Faulty Probe
149	Circuit 1, Water Condenser Outlet T°, Faulty Probe
202	Circuit 2, Condenser Fan Electrical Failure
203	Circuit 2, Condenser Inverter Electrical Failure
210	Circuit 2, Leak Refrigerant Detected
211	Circuit 2, Discharge T° Compressor 2, Overheating
212	Circuit 2, Discharge T° Compressor 2, Overheating
213	Circuit 2, Discharge T° Compressor 3, Overheating
214	Circuit 2, Compressor, Electrical Failure



CODE	DESCRIPTION
215	Circuit 2,High Pressure Cut Off
216	Circuit 2,Reversing Valve, Blocked
217	Circuit 2,LOP Low Operating Pressure
218	Circuit 2,Evaporator, Risk Of Frosting
219	Circuit 2,Low Condensing T°
221	Circuit 2,Evaporator Superheat Too High
222	Circuit 2,Evaporator Superheat Too Low
223	Circuit 2,Condenser Subcooling Too High
224	Circuit 2,Condenser Subcooling Too Low
227	Circuit 2,MOP, Maximum Operating Pressure
229	Circuit 2,High Condensing T°
231	Circuit 2,EEV, Valve Not Closed
232	Circuit 2,EEV, Motor
241	Circuit 2,High Pressure, Faulty Sensor
242	Circuit 2,Low Pressure, Faulty Sensor
243	Circuit 2,Liquid T°, Faulty Probe
244	Circuit 2,Suction T°, Faulty Probe
245	Circuit 2,Discharge T°, Compressor 2, Faulty Probe
246	Circuit 2,Discharge T°, Compressor 2, Faulty Probe
247	Circuit 2,Discharge T°, Compressor 3, Faulty Probe
248	Circuit 2,Water Condensing Inlet T°, Faulty Probe
249	Circuit 2,Water Condensing Outlet T°, Faulty Probe

**ALARM 001:  
WATER EVAPORATOR, FLOW SWITCH CUT OFF**

❖ **Description**

The flow switch has detected a low water flow rate in the evaporator heat exchanger for more than 5 seconds whereas the unit was enable.

❖ **Action**

Immediate shut down of the complete unit.

❖ **Reset**

Once the flow has been detected for 2 minutes, the alarm is automatically deleted. Up to 3 trips can occur during a day and are saved in the alarm historic. The two first trips don't give the alarm alert except if a trip is still present during 1 hour, and are automatically reset every day at 6h00 am. The third trip activates the fault report and must be manually reset.

❖ **Possible cause(s)**

- Problem with the pump control wiring,
- Problem with the flow switch wiring,
- Dirty or clogged water filter,
- Wrong setting of the flow switch.

❖ **Remedies**

- Check the pump(s) connections,
- Check the flow switch connections,
- Clean the water filter,
- Check the flow switch settings.

**ALARM 002:  
WATER CONDENSER, FLOW SWITCH CUT OFF**

❖ **Description**

The flow switch has detected a low water flow rate in the condenser heat exchanger for more than 5 seconds whereas the unit was enable.

❖ **Action**

Immediate shut down of the complete unit.

❖ **Reset**

Once the flow has been detected for 2 minutes, the alarm is automatically deleted. Up to 3 trips can occur during a day and are saved in the alarm historic. The two first trips don't give the alarm alert except if a trip is still present during 1 hour, and are automatically reset every day at 6h00 am. The third trip activates the fault report and must be manually reset.

❖ **Possible cause(s)**

- Problem with the pump control wiring,
- Problem with the flow switch wiring,
- Dirty or clogged water filter,
- Wrong setting of the flow switch,

❖ **Remedies**

- Check the pump connections,
- Check the flow switch connections,
- Clean the water filter,
- Check the flow switch settings.

**ALARM 021, 022, 023, 024:  
WATER EVAPORATOR, OUT OF RANGE**

❖ **Description**

The water evaporator temperature (Inlet or Outlet) measured by the probe is outside of the permitted range. This operating range can vary according to the presence or not of glycol with the chilled water.

- Alarm 021: The outlet water temperature is higher than the safety limit setting (**3274**) in heating mode,
- Alarm 022: The outlet water temperature is lower than the safety limit setting (**3271**) in cooling mode,
- Alarm 023: The inlet water temperature is higher than the safety limit setting (**3272**) in cooling mode,
- Alarm 024: The inlet water temperature is lower than the safety limit setting (**3273**) in heating mode.

❖ **Action**

Immediate shut down of the complete unit. The alarm is signalling 5 min after if the water evaporator temperature is still out of the permitted range.

❖ **Reset**

The alarm is automatically deleted once the temperature has reached the permitted operating range for 2min. After a change over mode (cool / heat), these alarms are reset during 15min.

❖ **Possible cause(s)**

- Temperature probe failed
- Problem with wiring of probe.

❖ **Remedies**

- Replace probe
- Check the connections of the probe.

**ALARM 025, 026, 027, 028:  
WATER CONDENSER, OUT OF RANGE**

❖ **Description**

The water condenser temperature (Inlet or Outlet) measured by the probe is outside of the permitted range.

- Alarm 025: \*\*\*\*\*
- Alarm 026: \*\*\*\*\*
- Alarm 027: \*\*\*\*\*
- Alarm 028: \*\*\*\*\*

❖ **Action**

Immediate shut down of the complete unit. The alarm is signalling 5 min after if the condenser temperature is still out of range.

❖ **Reset**

The alarm is automatically deleted once the temperature has reached the permitted operating range for 2min. After a change over mode, these alarms are reset during 15min.

❖ **Possible cause(s)**

- Problem with wiring of probe,
- Temperature probe failed.

❖ **Remedies**

- Check the connections of the probe,
- Replace probe.

## ALARM 034: ELECTRICAL BOX, AIR TEMPERATURE TOO HIGH

### ❖ Description

The air temperature measured by the probe placed in the electrical box is too high. This alarm is managed only on NAC or NAH units.

### ❖ Action

If the inside temperature is higher than 62.0°C for at least 5min, one of the circuit is stopped.  
If the inside temperature is higher than 65.0°C, for at least 5min, the two circuits are stopped.  
The alarm is signalling if one of the two limits is reached.

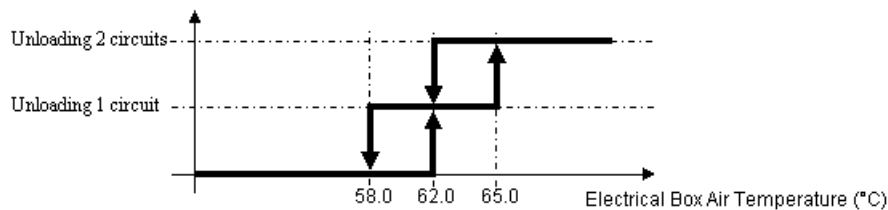

### ❖ Reset

The trip is automatic clear once the temperature has reached the permitted operating range for 2min (58.0°C).

### ❖ Possible cause(s)

- Temperature probe failed,
- Problem with wiring of probe,
- Inside air fan blower not operating,
- Inside air fan thermostat not operating or wrong adjusted.

### ❖ Remedies

- Replace probe,
- Check the connections of the probe,
- Check the air fan blower,
- Check the air fan thermostat.

**ALARM 041, 042:  
PUMP EVAPORATOR, ELECTRICAL FAILURE**

❖ **Description**

The thermal magnetic circuit breaker protection of the evaporator pump 1 or 2 has tripped for 5s, whereas the pump was in demand for at least 5s.

- Alarm 41: Thermal magnetic circuit breaker protection of the pump 1,
- Alarm 42: Thermal magnetic circuit breaker protection of the pump 2.

❖ **Action**

**Case of single pump:**

- Immediate shut down of the pump and the unit.
- The alarm is signalling.

**Case of double pump:**

- Immediate shut down of the current pump and the compressor(s).
- Time delay of 30s,
- Start the second pump if possible (refers to the “PUMP EVAPORATOR MANAGMENT“ paragraph)
- The alarm is signalling.

❖ **Reset**

These alarms are manually reset.

❖ **Possible cause(s)**

- Problem with wiring connection,
- Circuit breaker wrong adjusted.

❖ **Remedies**

- Check the pump(s) connections,
- Adjust the circuit breaker.

**ALARM 043, 044:  
PUMP CONDENSER, ELECTRICAL FAILURE**

❖ **Description**

The thermal magnetic circuit breaker protection of the condenser pump 1 or 2 has tripped for 5s, whereas the pump was in demand for at least 5s.

- Alarm 43: Thermal magnetic circuit breaker protection of the pump 1,
- Alarm 44: Thermal magnetic circuit breaker protection of the pump 2.

❖ **Action**

**Case of single pump:**

- Immediate shut down of the pump and the unit.
- The alarm is signalling.

**Case of double pump:**

- Immediate shut down of the current pump and the compressor(s).
- Time delay of 30s,
- Start the second pump if possible (refers to the “PUMP CONDENSER MANAGMENT“ paragraph)
- The alarm is signalling.

❖ **Reset**

These alarms are manually reset.

❖ **Possible cause(s)**

- Problem with wiring connection,
- Circuit breaker wrong adjusted.

❖ **Remedies**

- Check the pump connections,
- Adjust the circuit breaker.



**ALARM 045, 046:  
PUMP EVAPORATOR, FAULTY PRESSURE SENSOR**

❖ **Description**

The evaporator water pressure (In or Out) measured by the sensor is outside of the permitted range. This alarm is managed only if the “evaporator variable flow” option is selected.

- Alarm 45: Water evaporator pressure sensor IN faulty,
- Alarm 46: Water evaporator pressure sensor OUT faulty.

❖ **Action**

- Immediate shut down of the pump and the unit.
- The alarm is signalling.

❖ **Reset**

Once the CLIMATIC™ 60 has read correct pressure values for 2 minutes, the alarm is automatically deleted. Up to 3 trips can occur during a day and are saved in the alarm historic. The two first trips don't give the alarm alert except if a trip is still present during 1 hour, and are automatically reset every day at 6h00 am. The third trip activates the fault report and must be manually reset.

❖ **Possible cause(s)**

- Problem with wiring connection (sensor in short circuit or disconnected),
- Sensor damaged.

❖ **Remedies**

- Check the wiring connections,
- Replace the sensor.

**ALARM 047, 048:  
PUMP CONDENSER, FAULTY PRESSURE SENSOR**

❖ **Description**

The water pressure of the condenser pump (In or Out) measured by the sensor is outside of the permitted range. This alarm is managed only when the condenser variable flow option is selected.

- Alarm 47: Water condenser pressure sensor IN faulty,
- Alarm 48: Water condenser pressure sensor OUT faulty.

❖ **Action**

- Immediate shut down of the pump and the unit.
- The alarm is signalling.

❖ **Reset**

Once the CLIMATIC™ 60 has read correct pressure values for 2 minutes, the alarm is automatically deleted. Up to 3 trips can occur during a day and are saved in the alarm historic. The two first trips don't give the alarm alert except if a trip is still present during 1 hour, and are automatically reset every day at 6h00 am. The third trip activates the fault report and must be manually reset.

❖ **Possible cause(s)**

- Problem with wiring connection (sensor in short circuit or disconnected),
- Sensor damaged.

❖ **Remedies**

- Check the wiring connections,
- Replace the sensor.

**ALARM 061, 062, 063, 064, 065, 066, 067, 068:  
CLIMATIC BOARD LINK, FAILURE**

❖ **Description**

The link between the master / slave CLIMATIC™ 60 boards is faulty.

- Alarm 61: Master CLIMATIC™ 60 N°1 board disconnected,
- Alarm 62 -- > 68: Slave CLIMATIC™ 60 board N° 2→8 disconnected.

❖ **Action**

- Immediate swap the unit in stand alone mode.
- The alarm is signalling.

❖ **Reset**

Once the communication is re-established for 30s, the alarm is automatically deleted. Up to 6 trips can occur during a day and are saved in the alarm historic. The five first trips don't give the alarm alert except if a trip is still present during 1 hour, and are automatically reset every day at 6h00 am. The sixth trip activates the fault report and must be manually reset.

❖ **Possible cause(s)**

- Problem with wiring connection,
- CLIMATIC™ 60 board power off,
- CLIMATIC™ 60 board damaged.

❖ **Remedies**

- Check the wiring connections,
- Check the power of CLIMATIC™ 60 board,
- Replace the CLIMATIC™ 60 board.

## ALARM 070: REAL TIME CLOCK BOARD, FAILURE

### ❖ Description

The real time clock board of the CLIMATIC™ 60 doesn't work. The battery is out of order or wrong placed.

### ❖ Action

- The alarm is signalling.

### ❖ Reset

The alarm is manually reset.

### ❖ Possible cause(s)

- Battery level too low,
- CLIMATIC™ 60 board damaged.

### ❖ Remedies

- Replace the battery (Do not dispose of the product as municipal waste; it must be disposed of through specialist waste disposal centres),
- Replace the CLIMATIC™ 60 board.

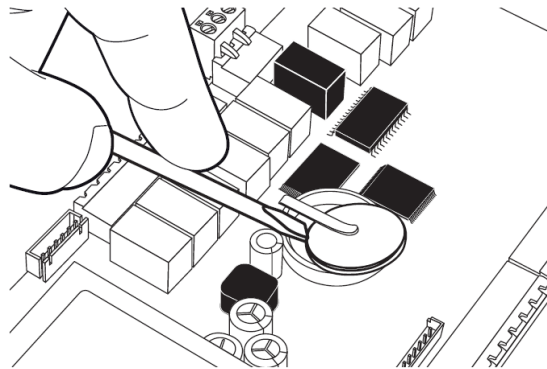

**ALARM 071, 072:  
EXPANSION BOARD LINK, FAILURE**

❖ **Description**

The link between the expansion board(s) 1 or 2 and the CLIMATIC™ 60 is disconnected.

- Alarm 71: The expansion board N°1 is disconnected from the CLIMATIC™ 60,
- Alarm 72: The expansion board N°2 is disconnected from the CLIMATIC™ 60.

❖ **Action**

- Immediate shut down of the unit.
- The alarm is signalling.

❖ **Reset**

Once the communication is re-established for 30s, the alarm is automatically deleted. Up to 6 trips can occur during a day and are saved in the alarm historic. The five first trips don't give the alarm alert except if a trip is still present during 1 hour, and are automatically reset every day at 6h00 am. The sixth trip activates the fault report and must be manually reset.

❖ **Possible cause(s)**

- Problem with wiring connection,
- Wrong expansion board address,
- Expansion board damaged.

❖ **Remedies**

- Check the wiring connections,
- Check the expansion board address (refers to the "FREE INPUT / OUTPUT" paragraph),
- Replace the expansion board.

**ALARM 073, 074, 075, 076, 077, 078:  
INVERTER LINK, FAILURE**

❖ **Description**

The link between the inverter and the CLIMATIC™ 60 has been disconnected for 5s.

- Alarm 073: The evaporator pump inverter is disconnected from the CLIMATIC™ 60,
- Alarm 074: The condenser pump inverter is disconnected from the CLIMATIC™ 60,
- Alarm 075: The condenser fan inverter of the circuit 1 is disconnected from the CLIMATIC™ 60,
- Alarm 076: The condenser fan inverter of the circuit 2 is disconnected from the CLIMATIC™ 60,
- Alarm 077: The condenser fan inverter of the circuit 1/2 is disconnected from the CLIMATIC™ 60,
- Alarm 078: The condenser fan inverter of the freecooling is disconnected from the CLIMATIC™ 60.

❖ **Action**

- Alarm 073: Immediate shut down of the complete unit. The alarm is signalling,
- Alarm 074: Immediate shut down of the complete unit. The alarm is signalling,
- Alarm 075: Immediate shut down of the circuit 1. The alarm is signalling,
- Alarm 076: Immediate shut down of the circuit 2. The alarm is signalling,
- Alarm 077: Doesn't stop the circuit 1 or 2. The alarm is signalling,
- Alarm 078: Doesn't stop the unit. The alarm is signalling.

❖ **Reset**

Once the communication is re-established for 2 minutes, the alarm is automatically deleted. Up to 6 trips can occur during a day and are saved in the alarm historic. The five first trips don't give the alarm alert except if a trip is still present during 1 hour, and are automatically reset every day at 6h00 am. The sixth trip activates the fault report and must be manually reset.

❖ **Possible cause(s)**

- Problem with wiring connection,
- Wrong inverter address,
- Inverter damaged.

❖ **Remedies**

- Check the wiring connections,
- Check the inverter address,
- Replace the inverter.

**ALARM 081, 083, 085, 089, 090, 141, 142, 143, 144, 145, 146, 148, 149, 241, 242, 243, 244, 245, 246, 248, 249:**  
**PROBE & SENSOR, FAULTY**

❖ **Description**

The temperature probe or pressure sensor measured by the CLIMATIC™ 60 or other expansion boards is incorrect. The device may be disconnected or in short circuit for 5s.

- Alarm 081: The inlet water evaporator temperature probe value is incorrect,
- Alarm 083: The outside air temperature probe value is incorrect,
- Alarm 085: The outlet water evaporator temperature probe value is incorrect,
- Alarm 089: The inside electrical box air temperature probe value is incorrect,
- Alarm 090: The inlet freecooling water temperature probe value is incorrect,
- Alarm 141: The high pressure sensor value on the circuit 1 is incorrect,
- Alarm 142: The low pressure sensor value on the circuit 1 is incorrect,
- Alarm 143: The liquid temperature probe value on the circuit 1 is incorrect,
- Alarm 144: The suction temperature probe value on the circuit 1 is incorrect,
- Alarm 145: The discharge temperature probe value on the circuit 1 – compressor 1 is incorrect,
- Alarm 146: The discharge temperature probe value on the circuit 1 – compressor 2 is incorrect,
- Alarm 148: The inlet water condenser temperature probe value on the circuit 1 is incorrect,
- Alarm 149: The outlet water condenser temperature probe value on the circuit 1 is incorrect,
- Alarm 241: The high pressure sensor value on the circuit 2 is incorrect,
- Alarm 242: The low pressure sensor value on the circuit 2 is incorrect,
- Alarm 243: The liquid temperature probe value on the circuit 2 is incorrect,
- Alarm 244: The suction temperature probe value on the circuit 2 is incorrect,
- Alarm 245: The discharge temperature probe value on the circuit 2 – compressor 1 is incorrect,
- Alarm 246: The discharge temperature probe value on the circuit 2 – compressor 2 is incorrect,
- Alarm 248: The inlet water condenser temperature probe value on the circuit 2 is incorrect,
- Alarm 249: The outlet water condenser temperature probe value on the circuit 2 is incorrect.

❖ **Action**

- Alarm 081: Immediate shut down of the complete unit. The alarm is signalling,
- Alarm 083: Immediate shut down of the complete unit. The alarm is signalling,
- Alarm 085: Immediate shut down of the complete unit. The alarm is signalling,
- Alarm 089: Doesn't stop the unit. The alarm is signalling,
- Alarm 090: Doesn't stop the unit. The alarm is signalling.
- Alarm 141: Immediate shut down of the circuit 1. The alarm is signalling,
- Alarm 142: Immediate shut down of the circuit 1. The alarm is signalling,
- Alarm 143: Immediate shut down of the circuit 1. The alarm is signalling,
- Alarm 144: Immediate shut down of the circuit 1. The alarm is signalling,
- Alarm 145: Immediate shut down of the circuit 1. The alarm is signalling,
- Alarm 146: Immediate shut down of the circuit 1. The alarm is signalling,
- Alarm 148: Immediate shut down of the circuit 1 and the circuit 2, only if there is one condenser for the both circuits,
- Alarm 149: Immediate shut down of the circuit 1 and the circuit 2, only if there is one condenser for the both circuits,

- Alarm 241: Immediate shut down of the circuit 2. The alarm is signalling,
- Alarm 242: Immediate shut down of the circuit 2. The alarm is signalling,
- Alarm 243: Immediate shut down of the circuit 2. The alarm is signalling,
- Alarm 244: Immediate shut down of the circuit 2. The alarm is signalling,
- Alarm 245: Immediate shut down of the circuit 2. The alarm is signalling,
- Alarm 246: Immediate shut down of the circuit 2. The alarm is signalling,
- Alarm 248: Immediate shut down of the circuit 2. The alarm is signalling,
- Alarm 249: Immediate shut down of the circuit 2. The alarm is signalling,

#### ❖ **Reset**

Once the data read is coherent for 2 minutes, the alarm is automatically deleted. Up to 3 trips can occur during a day and are saved in the alarm historic. The two first trips don't give the alarm alert except if a trip is still present during 1 hour, and are automatically reset every day at 6h00 am. The third trip activates the fault report and must be manually reset.

#### ❖ **Possible cause(s)**

- Problem with wiring connection,
- Probe or sensor damaged.

#### ❖ **Remedies**

- Check the wiring connections,
- Replace the probe or sensor.



**ALARM 102, 104, 202:  
CONDENSER FAN, ELECTRICAL FAILURE**

❖ **Description**

The thermal motor protection of the condenser fan has detected an over temperature for 5s, while the fan motor was in demand for at least 5s.

- Alarm 102: Thermal motor protection of the condenser fan on circuit 1,
- Alarm 104: Thermal motor protection of the condenser fan on circuit 1/2,
- Alarm 202: Thermal motor protection of the condenser fan on circuit 2.

❖ **Action**

- Alarm 102: xxxxxxxxxxxx,
- Alarm 104: xxxxxxxxxxxx,
- Alarm 202: xxxxxxxxxxxx.

❖ **Reset**

Once the data read is coherent for 2 minutes, the alarm is automatically deleted. Up to 6 trips can occur during a day and are saved in the alarm historic. The five first trips don't give the alarm alert except if a trip is still present during 1 hour, and are automatically reset every day at 6h00 am. The sixth trip activates the fault report and must be manually reset.

❖ **Possible cause(s)**

- Wrong air flow operating,
- Problem with wiring connection,
- Fan motor damaged.

❖ **Remedies**

- Check the air system,
- Check the connection,
- Replace the fan motor.

**ALARM 049, 050, 054, 103, 105, 203:  
PUMP OR FAN INVERTER, FAILURE**

❖ **Description**

The CLIMATIC™ 60 has detected an alarm on the pump inverter or the fan inverter.

- Alarm 049: Inverter failure of the evaporator pump,
- Alarm 050: Inverter failure of the condenser pump,
- Alarm 054: Inverter failure of the freecooling fan,
- Alarm 103: Inverter failure of the condenser fan on circuit 1,
- Alarm 105: Inverter failure of the condenser fan on circuit 1/2,
- Alarm 203: Inverter failure of the condenser fan on circuit 2.

❖ **Action**

- Alarm 049: Immediate shut down of the complete unit. The alarm is signalling,
- Alarm 050: Immediate shut down of the complete unit. The alarm is signalling,
- Alarm 054: Immediate shut down of the freecooling fan. The alarm is signalling,
- Alarm 103: Immediate shut down of the circuit 1. The alarm is signalling,
- Alarm 105: Immediate shut down of the circuit 1/2. The alarm is signalling,
- Alarm 203: Immediate shut down of the circuit 2. The alarm is signalling.

❖ **Reset**

The alarm is manually reset.

❖ **Possible cause(s)**

- Problem with wiring connection,
- Pump or fan damaged,
- Inverter damaged.

❖ **Remedies**

- Check the inverter connection,
- Replace the pump or fan,
- Replace the inverter.

**ALARM 108:  
POWER FACTOR CORRECTION, ELECTRICAL FAILURE**

❖ **Description**

The thermal magnetic circuit breaker protection of the capacitors (cos phi) has tripped for 5s.

❖ **Action**

The alarm is signalling.

❖ **Reset**

The alarm is manually reset.

❖ **Possible cause(s)**

- Problem with wiring connection,
- Circuit breaker wrong adjusted.

❖ **Remedies**

- Check the capacitor connection,
- Adjust the circuit breaker.

**ALARM 110, 210:  
LEAK REFRIGERANT, DETECTION**

❖ **Description**

/\*\*\*\*\*/  
UNDER CONSTRUCTION  
/\*\*\*\*\*/

❖ **Action**

The alarm is signalling.

❖ **Reset**

The alarm is manually reset.

❖ **Possible cause(s)**

- Problem of refrigerant capacity.

❖ **Remedies**

- Check the frigorific operating.

<b>ALARM 111, 112, 211, 212: DISCHARGE TEMPERATURE COMPRESSOR, OVERHEATING</b>
--

**❖ Description**

The CLIMATIC™ 60 has detected an overheating discharge temperature on the compressor.

- Alarm 111: Overheating discharge temperature on the circuit 1 – compressor 1,
- Alarm 112: Overheating discharge temperature on the circuit 1 – compressor 2,
- Alarm 211: Overheating discharge temperature on the circuit 2 – compressor 1,
- Alarm 212: Overheating discharge temperature on the circuit 2 – compressor 2.

**❖ Action**

Immediate shut down of the compressor. The alarm is signalling.

**❖ Reset**

Once the discharge temperature has reached a permitted operating range for 2 minutes, the alarm is automatically deleted. Up to 6 trips can occur during a day and are saved in the alarm historic. The five first trips don't give the alarm alert except if a trip is still present during 1 hour, and are automatically reset every day at 6h00 am. The sixth trip activates the fault report and must be manually reset.

**❖ Possible cause(s)**

- Problem of refrigerant capacity,
- Compressor damage.

**❖ Remedies**

- Check the frigorific operating,
- Replace the compressor.

**ALARM 114, 214:  
COMPRESSOR, ELECTRICAL FAILURE**

❖ **Description**

The thermal magnetic circuit breaker protection or the thermal motor protection of the compressor has tripped.

- Alarm 114: Thermal magnetic circuit breaker on the circuit 1,
- Alarm 214: Thermal magnetic circuit breaker on the circuit 2.

❖ **Action**

Immediate shut down of the complete circuit. The alarm is signalling.

❖ **Reset**

The alarm is manually reset.

❖ **Possible cause(s)**

- Problem with wiring connection,
- Circuit breaker wrong adjusted,
- Compressor damage.

❖ **Remedies**

- Check the wiring connection,
- Adjust the circuit breaker,
- Replace the compressor.

**ALARM 115, 215:  
HIGH PRESSURE, CUT OFF**

❖ **Description**

The high pressure switch has trip for 5s while a compressor was running for 10s.

- Alarm 115: High pressure cut off on the circuit 1,
- Alarm 215: High pressure cut off on the circuit 2.

❖ **Action**

Immediate shut down of the complete circuit. The alarm is signalling.

❖ **Reset**

Once the circuit has been stopped for 30 minutes, the alarm is automatically deleted. Up to 3 trips can occur during a day and are saved in the alarm historic. The two first trips don't give the alarm alert except if a trip is still present during 1 hour, and are automatically reset every day at 6h00 am. The third trip activates the fault report and must be manually reset.

❖ **Possible cause(s)**

- Problem with wiring connection,
- Coil condenser dirty,
- Fan condenser not operating.

❖ **Remedies**

- Check the wiring connection,
- Clean the coil condenser,
- Check the fan operating.

**ALARM 116, 216:  
REVERSING VALVE, BLOCKED**

❖ **Description**

The CLIMATIC™ 60 hasn't measure a difference of pressure of 2 bars for 5s, while a compressor was running for 30s.

- Alarm 116: Reversing valve blocked on the circuit 1,
- Alarm 216: Reversing valve blocked on the circuit 2.

❖ **Action**

Immediate shut down of the complete circuit. The alarm is signalling.

❖ **Reset**

Once the circuit has been stopped for 2 minutes, the alarm is automatically deleted. Up to 3 trips can occur during a day and are saved in the alarm historic. The two first trips don't give the alarm alert except if a trip is still present during 1 hour, and are automatically reset every day at 6h00 am. The third trip activates the fault report and must be manually reset.

❖ **Possible cause(s)**

- Problem with wiring connection,
- Problem of reversing valve.

❖ **Remedies**

- Check the wiring connection,
- Replace the reversing valve.



**ALARM 117, 217:  
LOW OPERATING PRESSURE, FAULTY**

❖ **Description**

The suction temperature calculated by the LP pressure sensor is lower than the permitted threshold. The temperature has reach -27.0°C (1 minute delayed in heating mode) while a compressor was running for 30s. The alarm is disable during 1 minute if the defrost procedure is running. In any case if the T°LP reaches -37.0°C, the circuit is stopped immediately without time delay.

- Alarm 117: Suction temperature too low on the circuit 1,
- Alarm 217: Suction temperature too low on the circuit 2.

❖ **Action**

Immediate shut down of the complete circuit. The alarm is signalling.

❖ **Reset**

Once the circuit has been stopped for 2 minutes, the alarm is automatically deleted. Up to 3 trips can occur during a day and are saved in the alarm historic. The two first trips don't give the alarm alert except if a trip is still present during 1 hour, and are automatically reset every day at 6h00 am. The third trip activates the fault report and must be manually reset.

❖ **Possible cause(s)**

- Problem of refrigerant capacity.

❖ **Remedies**

- Check the frigorific operating.

**ALARM 118, 218:  
WATER EVAPORATOR, RISK OF FROSTING**

❖ **Description**

The suction pressure measured by the LP sensor is too low and may pose a risk for the water evaporator. These alarms are disabled if the unit has electronic expansion valve (EEV) or if the glycol rate is greater than 45%. The LP pressure has reach the limit specifyd in the setting (**3441**) for 2 minutes while a compressor was running for at least 2 minutes. This alarm is disabled during 1 minute when a compressor start or stop or during the defrost procedure.

- Alarm 118: Risk of frosting the water evaporator by the circuit 1,
- Alarm 218: Risk of frosting the water evaporator by the circuit 2.

❖ **Action**

Immediate shut down of the complete circuit. The alarm is signalling.

❖ **Reset**

Once the suction pressure is higher than the setting (**3441**) for 2 minutes, the alarm is automatically deleted. Up to 3 trips can occur during a day and are saved in the alarm historic. The two first trips don't give the alarm alert except if a trip is still present during 1 hour, and are automatically reset every day at 6h00 am. The third trip activates the fault report and must be manually reset.

❖ **Possible cause(s)**

- Problem of refrigerant capacity
- Problem with the expansion valve.

❖ **Remedies**

- Check the frigorific operating,
- Replace the expansion valve.

<b>ALARM 121, 221: EVAPORATOR, TEMPERATURE SUPERHEAT TOO HIGH</b>
---

**❖ Description**

/\*\*\*\*\*/  
UNDER CONSTRUCTION  
/\*\*\*\*\*/

- Alarm 121: Superheat temperature too high on the circuit 1,
- Alarm 221: Superheat temperature too high on the circuit 2.

**❖ Action**

Immediate shut down of the complete circuit. The alarm is signalling.

**❖ Reset**

Once the circuit has been stopped for 2 minutes, the alarm is automatically deleted. Up to 3 trips can occur during a day and are saved in the alarm historic. The two first trips don't give the alarm alert except if a trip is still present during 1 hour, and are automatically reset every day at 6h00 am. The third trip activates the fault report and must be manually reset.

**❖ Possible cause(s)**

- Problem of refrigerant capacity
- Problem with the expansion valve.

**❖ Remedies**

- Check the frigorific operating,
- Replace the expansion valve.

**ALARM 122, 222:  
EVAPORATOR, TEMPERATURE SUPERHEAT TOO LOW**

❖ **Description**

/\*\*\*\*\*/  
UNDER CONSTRUCTION  
/\*\*\*\*\*/

- Alarm 122: Superheat temperature too low on the circuit 1,
- Alarm 222: Superheat temperature too low on the circuit 2.

❖ **Action**

Immediate shut down of the complete circuit. The alarm is signalling.

❖ **Reset**

Once the circuit has been stopped for 2 minutes, the alarm is automatically deleted. Up to 3 trips can occur during a day and are saved in the alarm historic. The two first trips don't give the alarm alert except if a trip is still present during 1 hour, and are automatically reset every day at 6h00 am. The third trip activates the fault report and must be manually reset.

❖ **Possible cause(s)**

- Problem of refrigerant capacity
- Problem with the expansion valve.

❖ **Remedies**

- Check the frigorific operating,
- Replace the expansion valve.

**ALARM 123, 223:  
CONDENSER, TEMPERATURE SUBCOOLING TOO HIGH**

❖ **Description**

/\*\*\*\*\*/  
UNDER CONSTRUCTION  
/\*\*\*\*\*/

- Alarm 123: Air / water evaporator subcooling too high on the circuit 1,
- Alarm 223: Air / water evaporator subcooling too high on the circuit 2.

❖ **Action**

Immediate shut down of the complete circuit. The alarm is signalling.

❖ **Reset**

❖ **Possible cause(s)**

- Problem of refrigerant capacity
- Problem with the expansion valve.

❖ **Remedies**

- Check the frigorific operating,
- Replace the expansion valve.

**ALARM 124, 224:  
CONDENSER, TEMPERATURE SUBCOOLING TOO LOW**

❖ **Description**

/\*\*\*\*\*/  
UNDER CONSTRUCTION  
/\*\*\*\*\*/

- Alarm 124: Air / water evaporator subcooling too low on the circuit 1,
- Alarm 224: Air / water evaporator subcooling too low on the circuit 2.

❖ **Action**

Immediate shut down of the complete circuit. The alarm is signalling.

❖ **Reset**

❖ **Possible cause(s)**

- Problem of refrigerant capacity
- Problem with the expansion valve.

❖ **Remedies**

- Check the frigorific operating,
- Replace the expansion valve.

**ALARM 127, 227:  
MOST OPERATING PRESSURE, FAULTY**

❖ **Description**

The suction pressure measured by the CLIMATIC™ 60 is outside a permitted range.

- Alarm 127: Most operating pressure on the circuit 1,
- Alarm 227: Most operating pressure on the circuit 2.

❖ **Action**

Immediate shut down of the complete circuit. The alarm is signalling.

❖ **Reset**

Once the circuit has been stopped for 2 minutes, the alarm is automatically deleted. Up to 3 trips can occur during a day and are saved in the alarm historic. The two first trips don't give the alarm alert except if a trip is still present during 1 hour, and are automatically reset every day at 6h00 am. The third trip activates the fault report and must be manually reset.

❖ **Possible cause(s)**

- Problem of refrigerant capacity.

❖ **Remedies**

- Check the frigorific operating.

**ALARM 129, 229:  
CONDENSING TEMPERATURE, TOO HIGH**

❖ **Description**

The condensing temperature measured by the CLIMATIC™ 60 is too high.

- Alarm 129: High condensing temperature on the circuit 1,
- Alarm 229: High condensing temperature on the circuit 2.

❖ **Action**

Immediate shut down one of the compressor on the circuit (the small one in uneven circuit, or the one which have the higher counter time for even circuit). The alarm is signalling.

❖ **Reset**

Once the condensing temperature has been enough decrease for 2 minutes, the alarm is automatically reset.

❖ **Possible cause(s)**

- Problem with wiring connection,
- Coil condenser dirty,
- Fan condenser not operating,
- Outside air temperature too high.

❖ **Remedies**

- Check the wiring connection,
- Clean the coil condenser,
- Check the fan operating.







[www.lennox europe.com](http://www.lennox europe.com)

**SALES OFFICES :**

**BELGIUM AND LUXEMBOURG**

+ 32 3 633 3045

**RUSSIA**

+7 495 626 56 53

**FRANCE**

+33 1 64 76 23 23

**SPAIN**

+34 902 533 920

**GERMANY**

+49 (0) 40 589 6235 0

**UKRAINE**

+380 44 461 87 79

**ITALY**

+ 39 02 495 26 200

**UNITED KINGDOM AND IRELAND**

+44 1604 669 100

**NETHERLANDS**

+ 31 332 471 800

**POLAND**

+48 22 58 48 610

**OTHER COUNTRIES :**

**PORTUGAL**

+351 229 066 050

**LENNOX DISTRIBUTION**

+33 4 72 23 20 00



MUL41E-0610/06-2011

Due to Lennox's ongoing commitment to quality, the Specifications, Ratings and Dimensions are subject to change without notice and without incurring liability.

Improper installation, adjustment, alteration, service or maintenance can cause property damage or personal injury.

Installation and service must be performed by a qualified installer and servicing agency