

# DOSSIER MECANIQUE & FRIGORIFIQUE KLIMATECHNISCHE DOKUMENTATION

Indice/Index	Date/Datum	Nom / Name	Modifications / Anderung
MCW 162 S K			Dessine / Name :
			Date / Datum : 13-03-2007

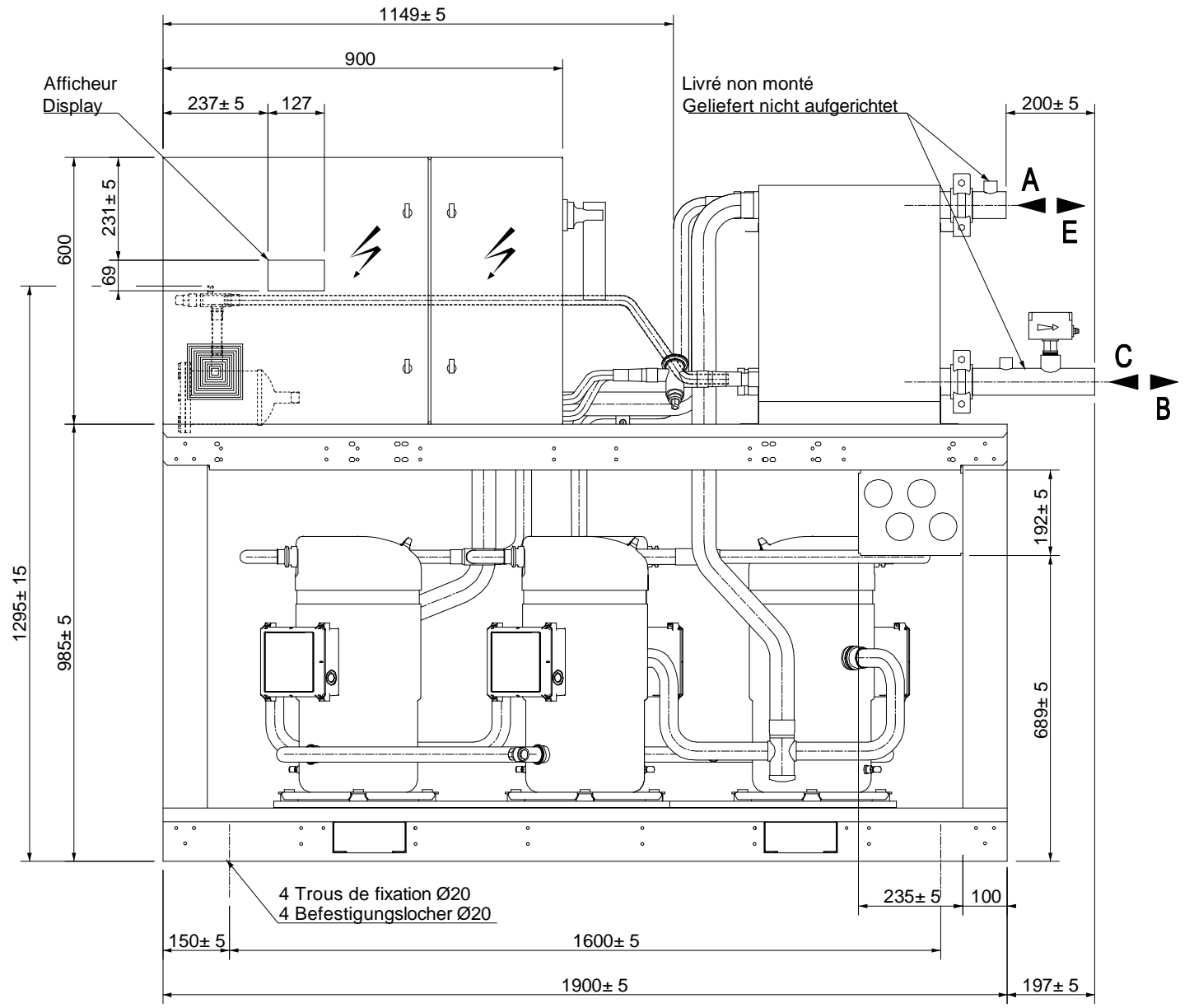
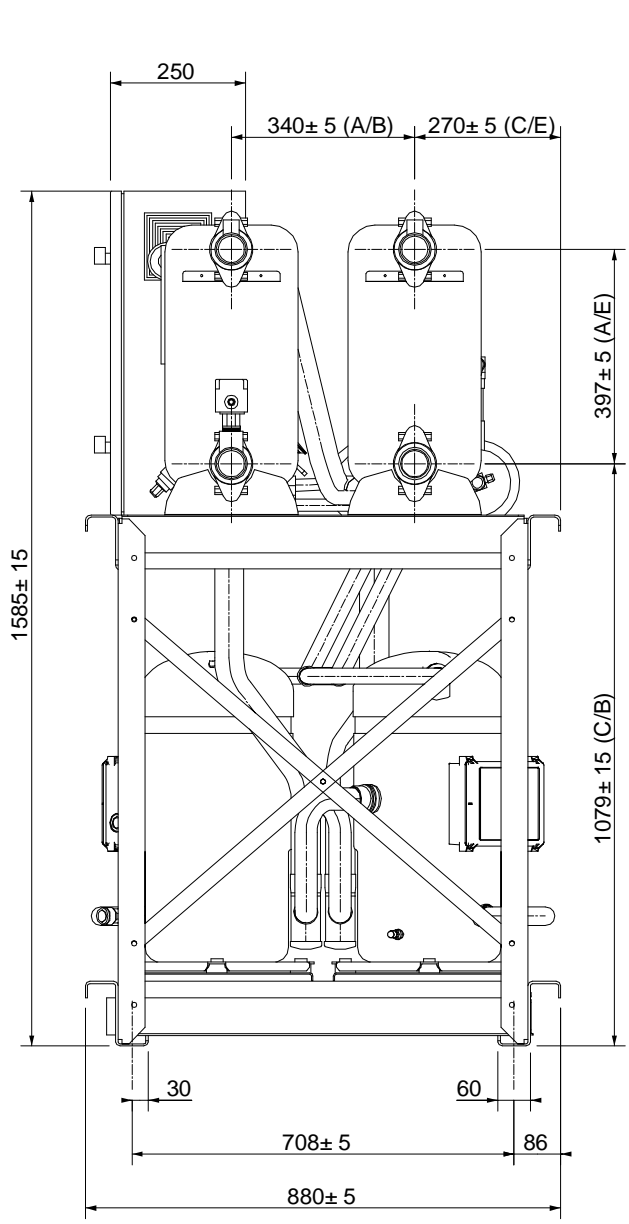

MCW-162-SK

.	.	.	.
Z	01/01/01	.	Emission initiale
Ind.	Date	Nom	Modification

# PLAN D'ENSEMBLE

Dessinateur : RF    Ech : 1/10    Date : 14/03/07    2/6

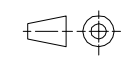

MCW-162-SK

## RACCORDEMENT HYDRAULIQUE HYDRAULIKVERBINDUNGEN

A	ENTREE / SORTIE EAU FROIDE	Ø 60.3 acier / stahl
B	EIN-/ AUSLAUF KALTWASSER	

C	ENTREE / SORTIE EAU CHAUDE	Ø 60.3 acier / stahl
E	EIN-/ AUSLAUF WARMWASSER	

POIDS DE LA MACHINE A VIDE : 0 kg

GEWICHT DER LEEREN MASCHINE

POIDS DE LA MACHINE EN SERVICE : 0 kg

GEWICHT DER BETRIEBSBEREITEN MASCHINE

ENTREE DU CABLE DE RACCORDEMENT PUISSANCE  
EINFUHRUNG DES LEISTUNGSKABELS

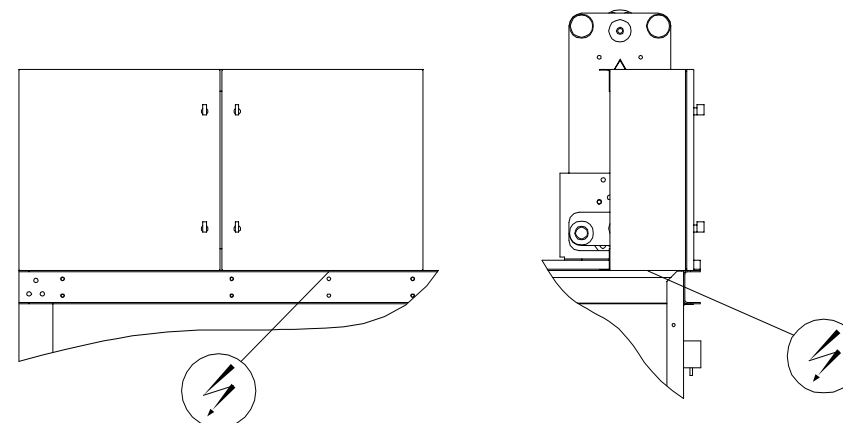

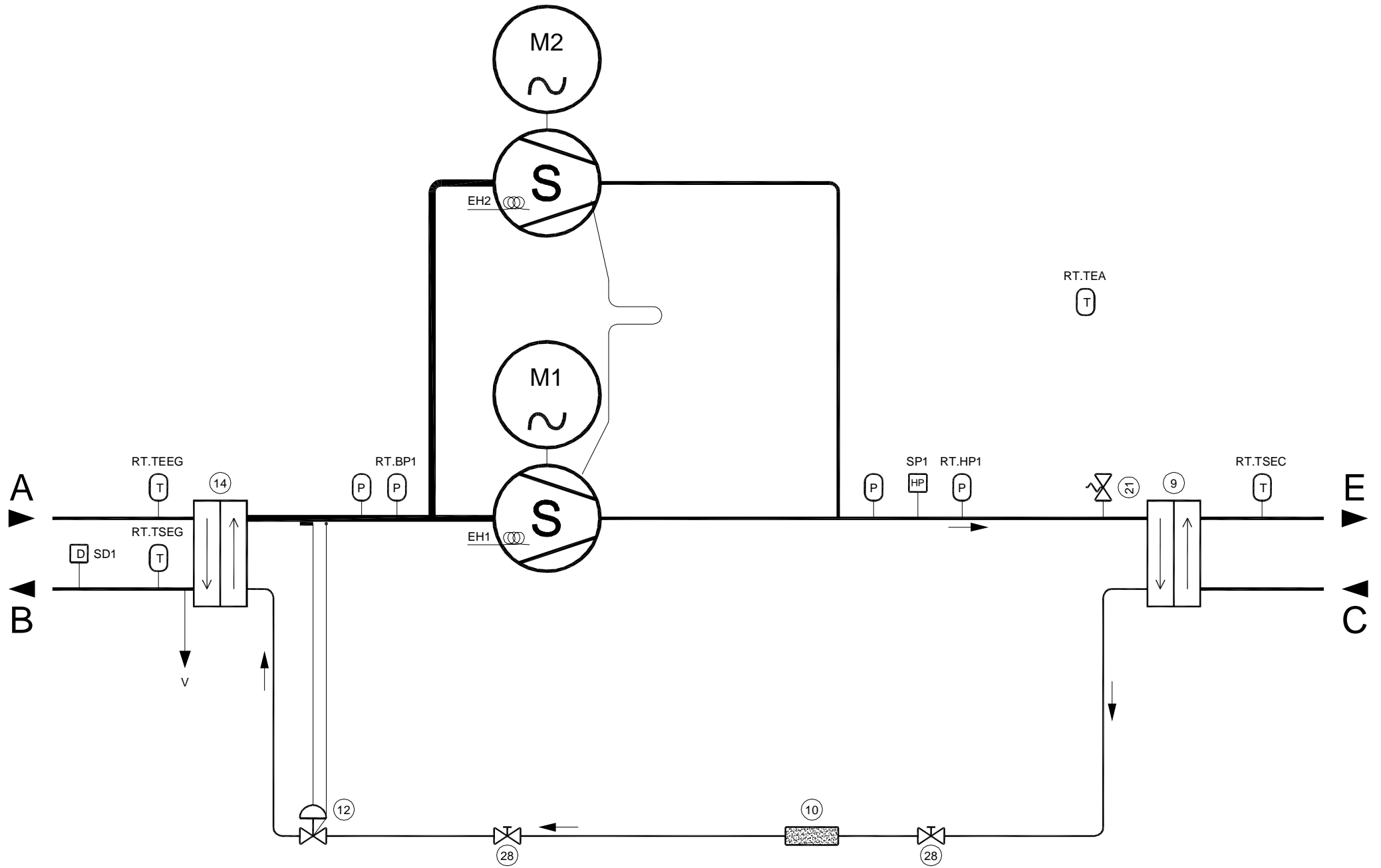





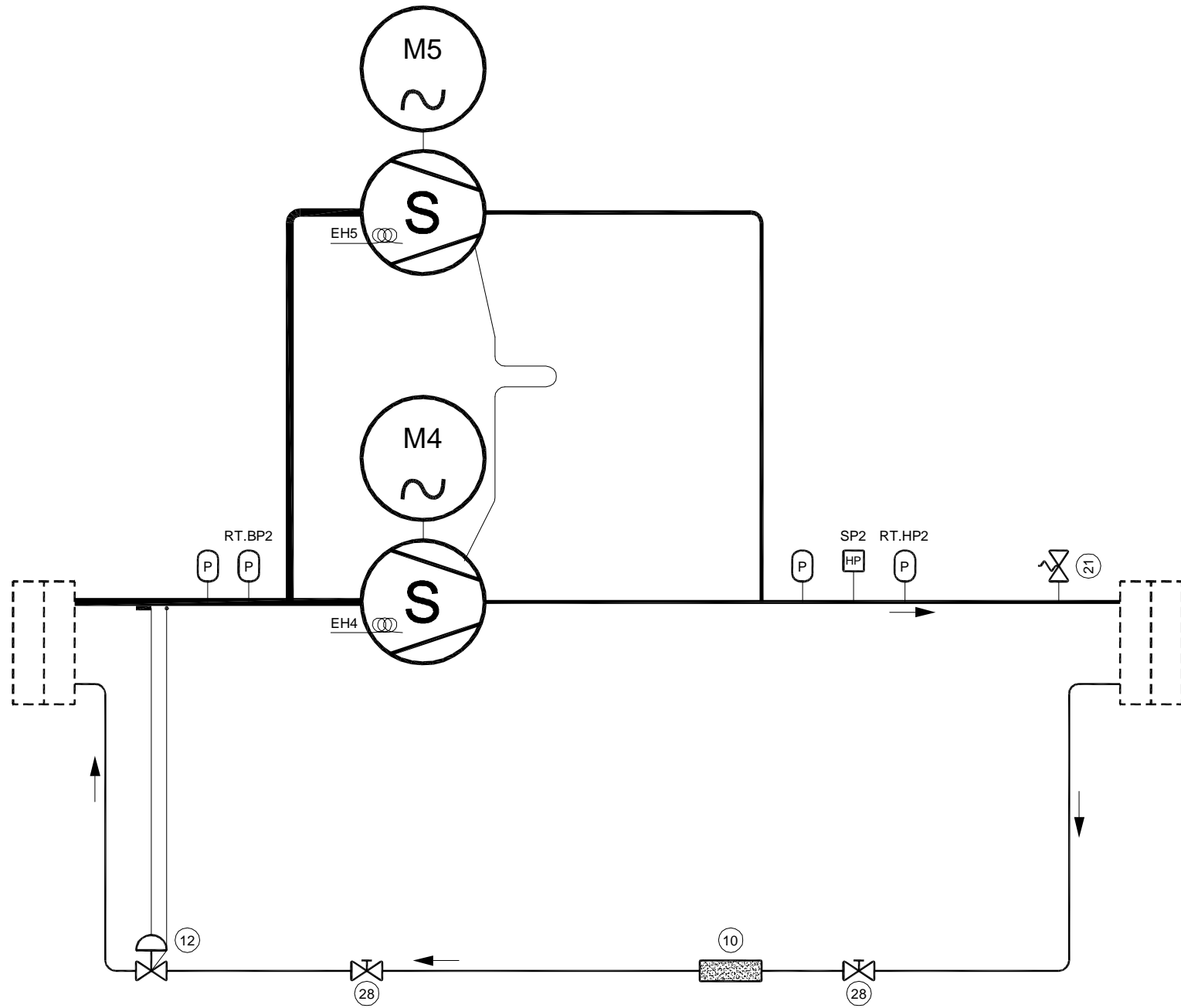













SCHEMA FRIGORIFIQUE

Indice	Date	Nom	Modifications



SCHEMA FRIGORIFIQUE (circuit 2)

Indice	Date	Nom	Modifications

1	Antivibratile Schwingungsdämpfer	16	Economiseur Economizer	31	Vase d'expansion šberlaufgefäß	 Compresseur a piston Kolbenverdichter	 Pressostat combin, BP + HP Kombinierter Druckwächter für Hoch- und Niederdruck   Vanne command, par pression Druckgesteuertes Ventil   Vanne a commande électrique Elektrisch gesteuertes Ventil   Résistance électrique E. Widerstand
2	Bac a eau Wassertank	17	Diaphragme Blende	32	Vanne de reglage Einstellventil	 Compresseur scroll Scroll-Verdichter	
3	Bouteille anti-coup de liquide Druckstossverhinderungssammler	18	Echangeurs divers Verschiedene Wärmetauscher	33	Vanne de vidange Ablassventil	 Compresseur a vis Schraubverdichter	
4	Bouteille reservoir Sammelspeicher	19	Purgeur d'air Luftablass	34	Disconnecteur Trennschalter	 Pompe Pumpe	
5	Vanne de remplissage Füllventil	20	Silencieux de refoulement Ausschubseitiger Schalldämpfer	35	Bouteille compensatrice Ausgleichssammler	 Moteur Motor	
6	Clapet de decharge eau Sammlier-Bypassklappe	21	Soupape de securite Sicherheitsventil	36	Vanne d'etalonnage manometre Manometer-Eichventil	 Controleur de débit Durchflusswächter	
7	Clapet de retenue Rückschlagklappe	22	Separateur d'huile Trennscheider	37	Dilution par capillaire Kapillarexpansion	 Controleur de niveau Niveauwächter	
8	Condenseur a air Luftgekühlter Verdichtiger	23	Vanne 3 voies 3-Wege-Ventil			 Controleur de pression Druckwächter	
9	Condenseur a eau Wassergekühlter Verdichtiger	24	Vanne 4 voies 4-Wege-Ventil			 Controleur de température Temperaturwächter	
10	Deshydrateur Entfeuchter	25	Vanne aspiration compresseur Saugseitiges Verdichterventil			 Indicateur de niveau Niveauanzeige	
11	Dentendeur electronique Elektronisches Expansionsventil	26	Vanne refoulement compresseur Förderseitiges Verdichterventil			 Indicateur de pression Druckanzeige	
12	Detendeur thermostatique Thermostatisches Expansionsventil	27	Vanne pressostatique Druckregelventil			 Indicateur de température Temperaturanzeige	
13	Filtre Filter	28	Vanne a main Handventil			 Pressostat basse pression Druckwächter Niederdruck	
14	Evaporateur a eau Wasserbetriebener Verdampfer	29	Evaporateur a air Luftbetriebener Verdampfer			 Pressostat haute pression Druckwächter Hochdruck	
15	Vidange Entleerung	30	Voyant liquide Meldelampe Flüssigkeit			 Pressostat d'huile Trenndruckwächter	

# MANUTENTION - HANDHABUNG

**POIDS  
GEWICHT**

**0 kg**

