

DOSSIER MECANIQUE & FRIGORIFIQUE KLIMATECHNISCHE DOKUMENTATION

Index/Index	Date/Datum	Nom / Name	Modifications / Änderung

AXIMA

MCW 132 S K AXIMA	Dessine / Name : R. PETREQUIN	1/6
	Date / Datum : 13-03-2007	

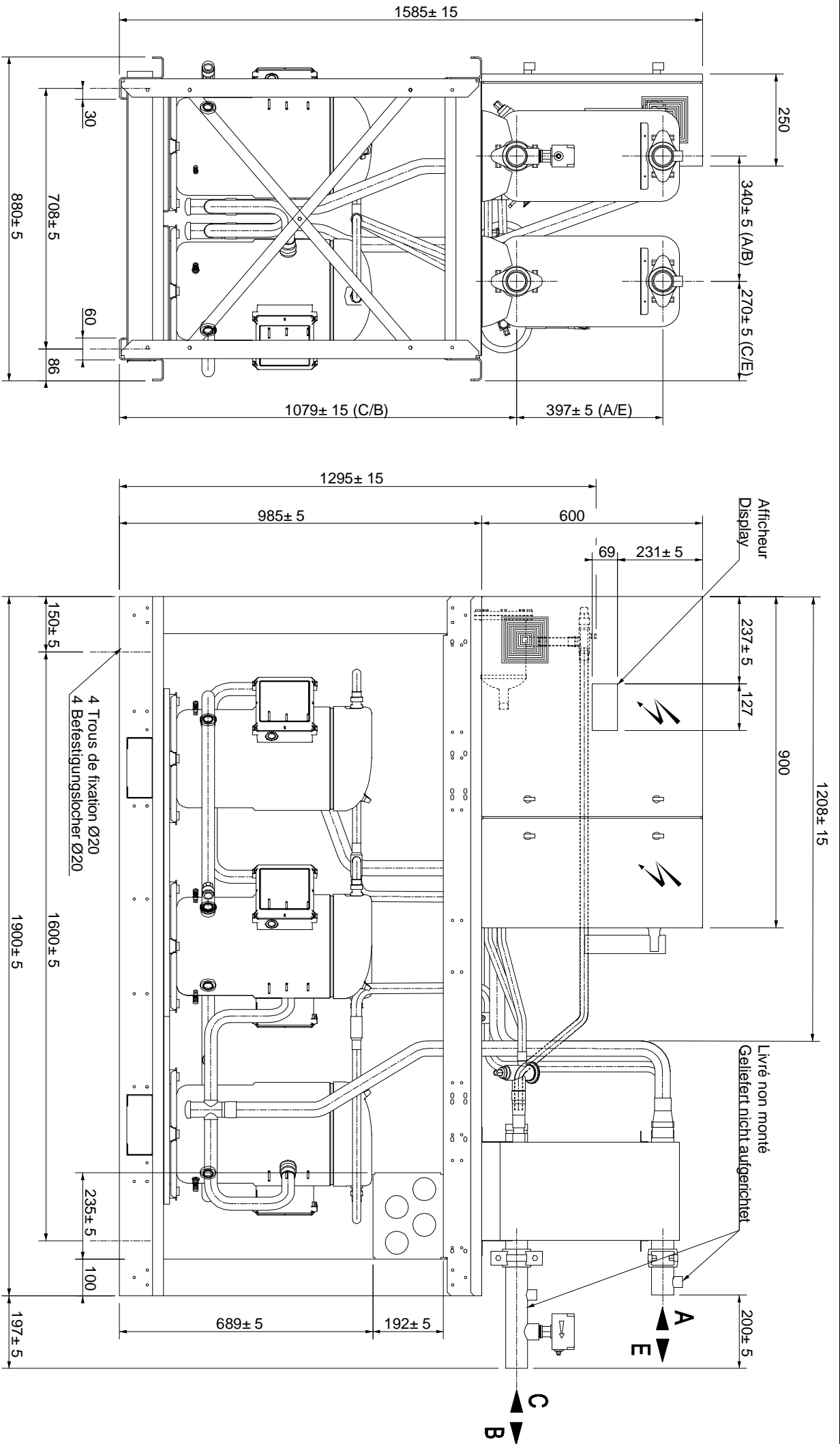

MCM-132-SK-AXIMA

Mod	.	.	.
Date	01/01/01	.	.
Norm	.	Emission Initiale	.
Modification			

PLAN D'ENSEMBLE

Dessinateur : RF	Ech : 1/10	Date : 09/03/07	2/6
			MCM-132-SK-AXIMA

RACCORDEMENT HYDRAULIQUE HYDRAULIKVERBINDUNGEN

A	ENTREE / SORTIE EAU FROIDE	Ø 60.3 acier / stahl
B	EIN- / AUSLAUF KALTWASSER	
C	ENTREE / SORTIE EAU CHAUDE	Ø 60.3 acier / stahl
E	EIN- / AUSLAUF WARMWASSER	

POIDS DE LA MACHINE A VIDE : 950 kg
GEWICHT DER LEEREN MASCHINE
POIDS DE LA MACHINE EN SERVICE : 990 kg
GEWICHT DER BETRIEBSBEREITEN MASCHINE

ENTREE DU CABLE DE RACCORDEMENT PUISSANCE
EINFUHRUNG DES LEISTUNGSKABELS

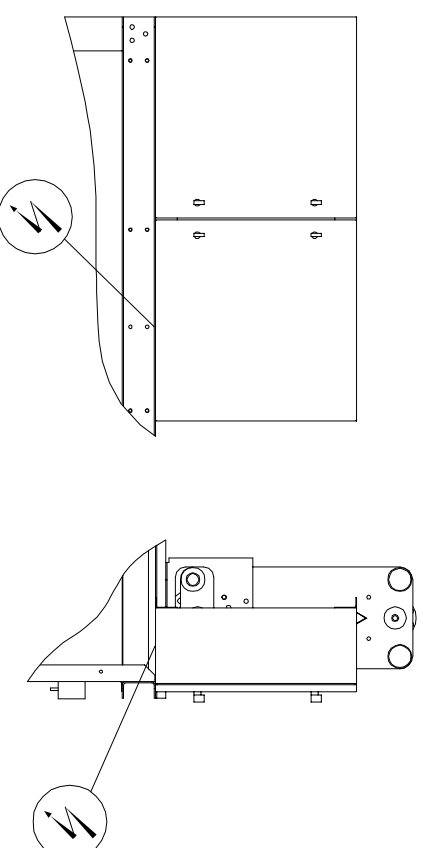

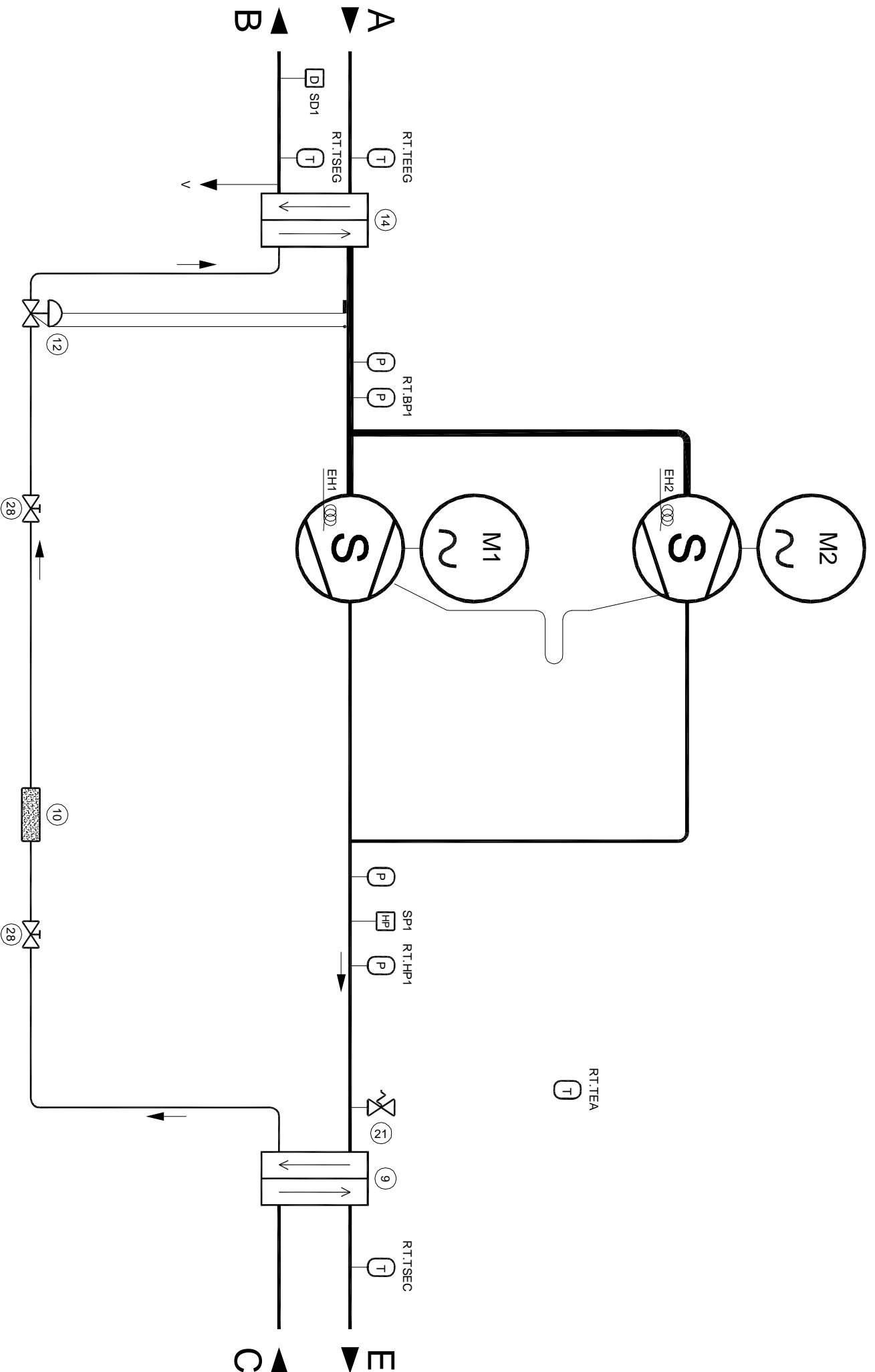





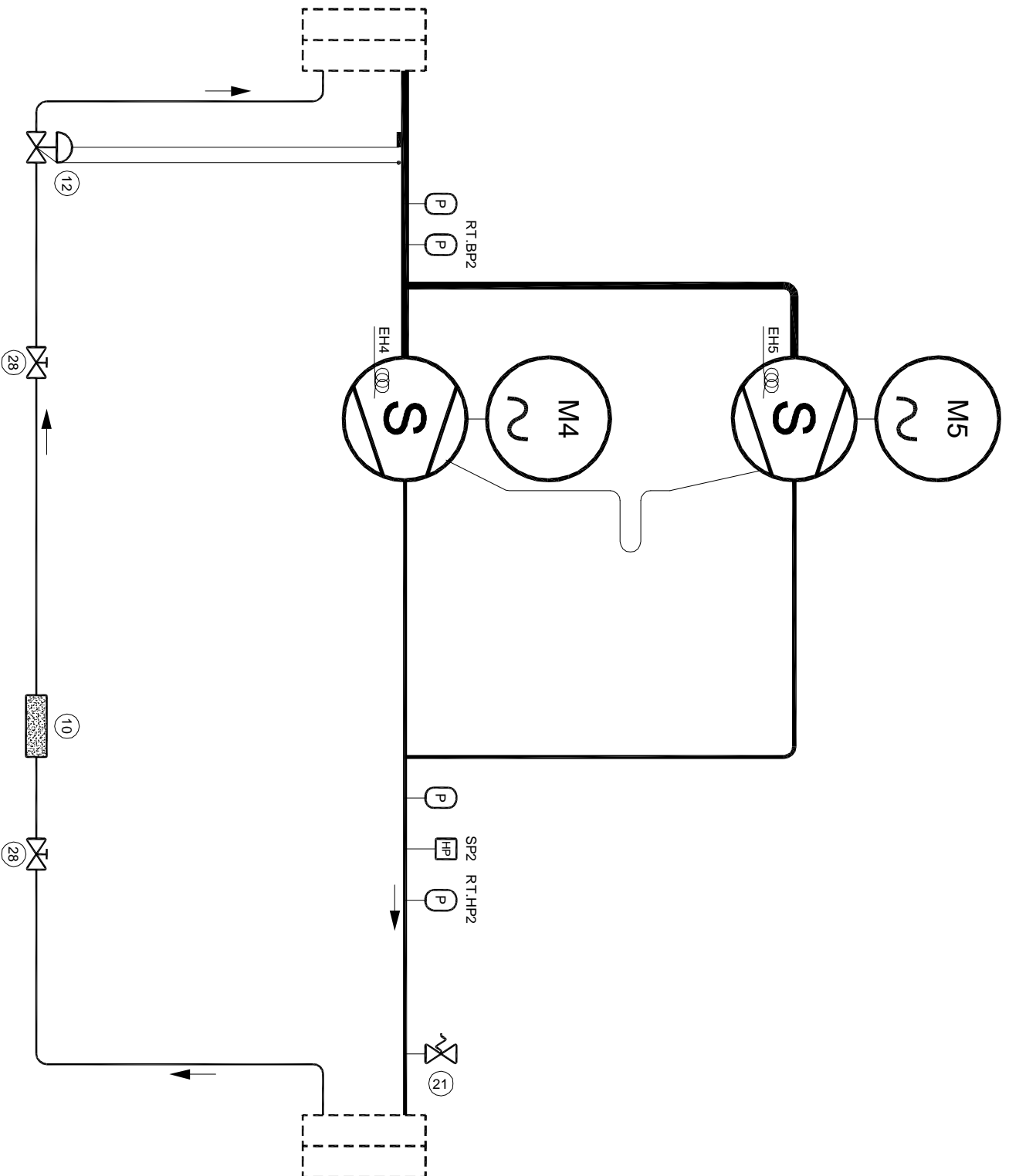













SCHEMA FRIGORIFIQUE

Indice	Date	Nom
Modifications		



SCHEMA FRIGORIFIQUE (circuit 2)

1	Antivibratie Schwingungsdämpfer	16	Economiseur Economizer	31	Vase d'expansion šberlaufgefäss		Compresseur a piston Kolbenverdichter		Pressostat combin. BP + HP Kombinierter Druckwächter für Hoch- und Niederdruck
2	Bac a eau Wasserank	17	Diaphragme Blende	32	Vanne de réglage Einstellventil		Compresseur scroll Scroll-Verdichter		
3	Boutelle anti-coup de liquide Druckstossvorhinderungsammier	18	Echangeurs divers Verschiedene Wärmetauscher	33	Vanne de vidange Ablassventil		Compresseur a vis Schraubverdichter		Vanne command. par pression Druckgesteuertes Ventil
4	Boutelle reservoir Sammelspeicher	19	Purgeur d'air Luftbläss	34	Disconnecteur Trennschalter		Pompe Pumpe		Vanne a commande électrique Elektrisch gesteuertes Ventil
5	Vanne de remplissage Füllventil	20	Silencieux de refoulement Ausschubseitiger Schalldämpfer	35	Boutelle compensatrice Ausgleichsammier		Moteur Motor		Résistance électrique E-Widerstand
6	Clapet de decoupage eau Sammier-Bypassklappe	21	Soupape de securite Sicherheitsventil	36	Vanne d'etalonnage manometre Manometer-Eichventil		Controlleur de débit Durchflusswächter		
7	Clapet de retenue Rückschlagklappe	22	Separateur d'huile Trennlabscheider	37	D tente par capillaire Kapillarexpansion		Controlleur de niveau Niveauwächter		
8	Condenseur a air Luftgekühlter Verflüssiger	23	Vanne 3 voies 3-Wege-Ventil				Controlleur de pression Druckwächter		
9	Condenseur a eau Wassergekühlter Verflüssiger	24	Vanne 4 voies 4-Wege-Ventil				Controlleur de température Temperaturwächter		
10	Dehydrateur Entfeuchter	25	Vanne aspiration compresseur Saugseitiges Verdichtenventil				Indicateur de niveau Niveauanzeigige		
11	Dentendeur électronique Elektronisches Expansionsventil	26	Vanne refoulement compresseur Förderseitiges Verdichtenventil				Indicateur de pression Druckanzeigige		
12	Détendeur thermostatique Thermostatisches Expansionsventil	27	Vanne pressostatique Druckregelventil				Indicateur de température Temperaturanzeigige		
13	Filtre Filter	28	Vanne a main Handventil				Pressostat basse pression Druckwächter Niederdruck		
14	Evaporateur a eau Wasserbetriebeber Verdampfer	29	Evaporateur a air Luftbetriebeber Verdampfer				Pressostat haute pression Druckwächter Hochdruck		
15	Vidange Entleerung	30	Voyant liquide Meldelampe Flüssigkeit				Pressostat d'huile Trenndruckwächter		

NOMENCLATURE FRIGORIFIQUE & HYDRAULIQUE

MANUTENTION - HANDHABUNG

**POIDS
GEWICHT 950 kg**

