

ELEMENTOS OPCIONALES  
OPTIONAL ELEMENTS

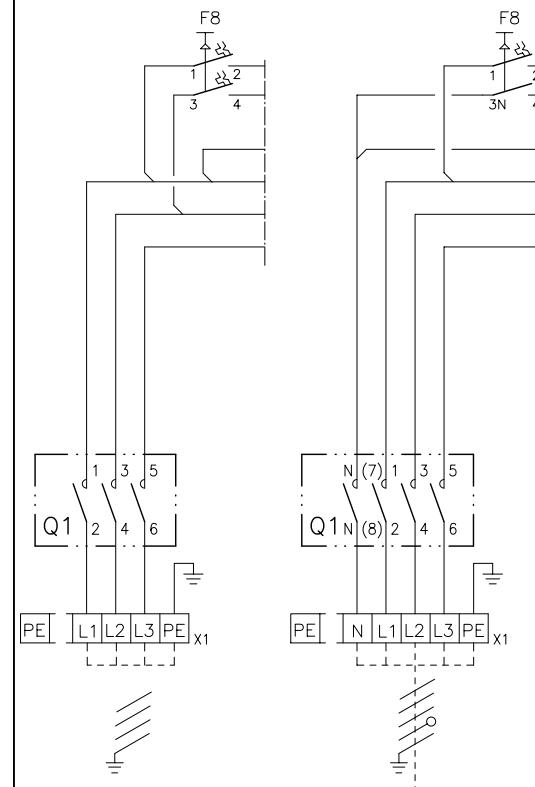

Fusibles	F1	F3
Fuses size	3 x 20A	1 x 6A
400/3/50	3 x 10A	1 x 6A

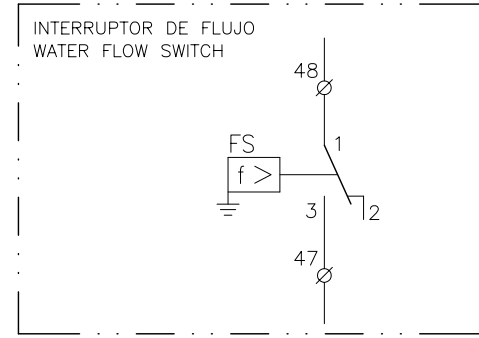
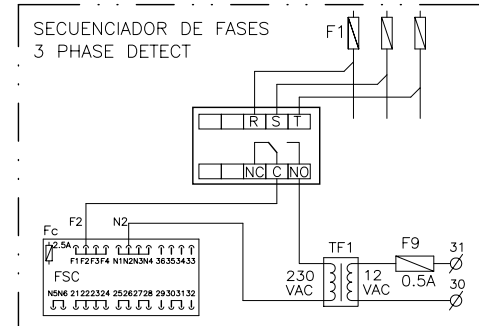
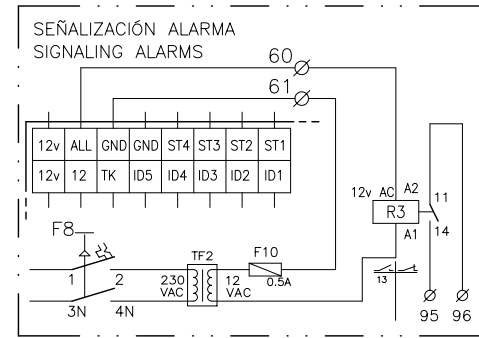
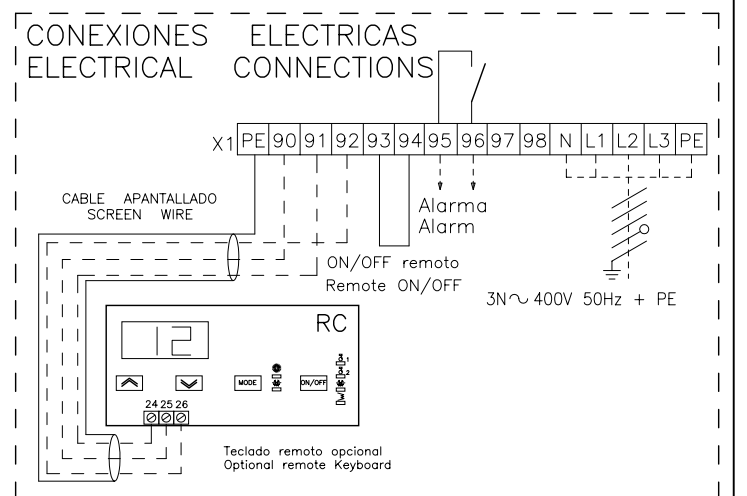
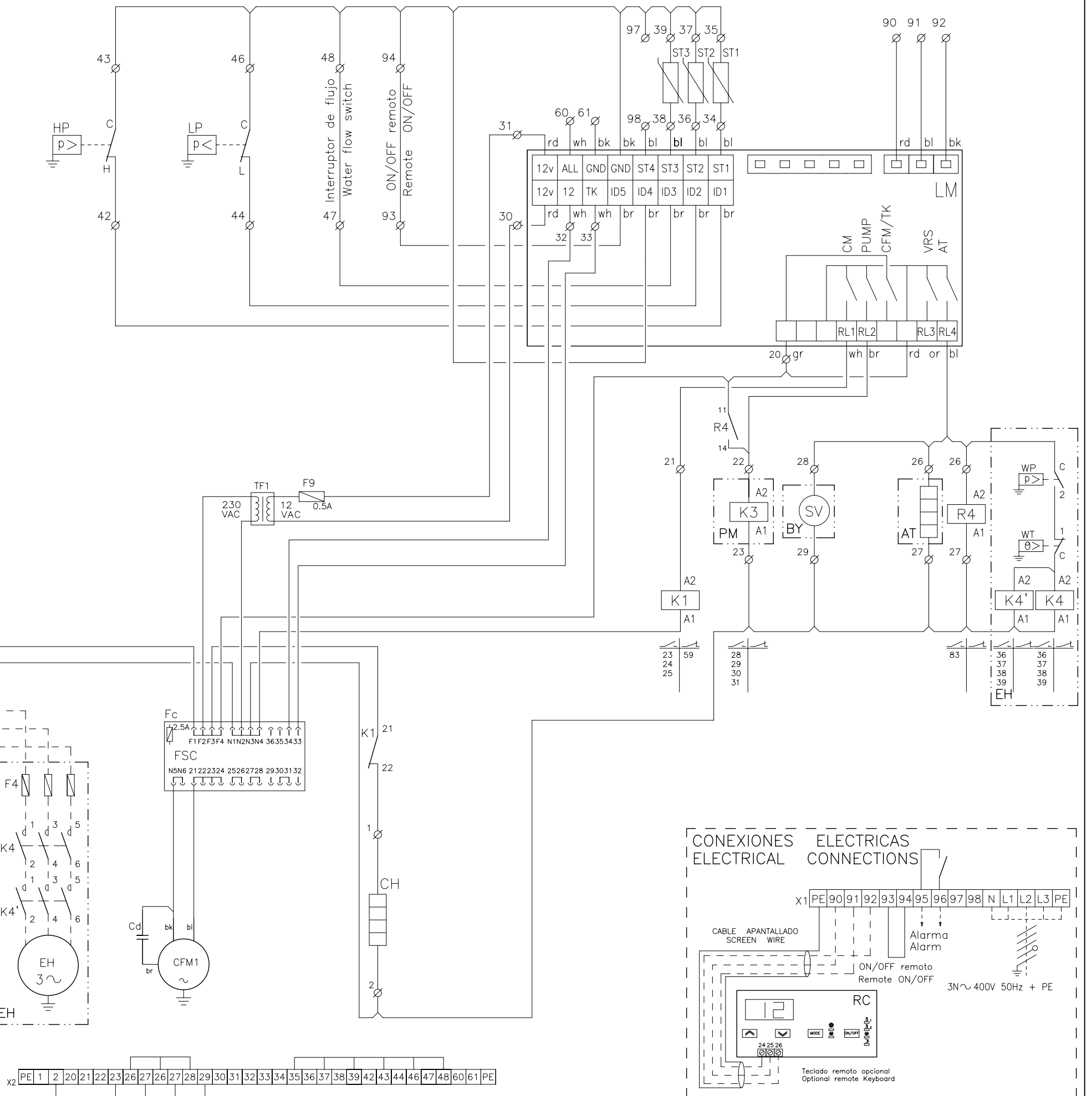

Elemento Opcional  
Optional Element  
A Realizar por el Instalador  
To Wire by the Installer

Lennox Refac S.A. ESQUEMA ELECTRICO  
ELECTRIC DIAGRAM

EAC 0091SK

3Z-33-507-211 19C  
3N ~ 400V 50HZ + PE  
3 ~ 230V 50HZ + PE