

**INSTRUCTIONS FOR USE OF
ELECTRONIC CONTROL UNIT**

RKE

RKE FO – RKE BF

RHR

SRS

Series

Index

1. ELECTRONIC CONTROL UNIT	page 3
2. GENERAL FUNCTIONS	page 7
3. CONTROL LOGIC	page 15
4. CLOCK PROGRAM SETTING	page 29
5. SUPERVISION (BMS)	page 31
6. TROUBLESHOOTING	page 42

1. Electronic control

The system of electronic control installed consists of the room terminal and power circuits, which are connected by an electric cord with two wires. The terminal, which should be installed in a readily accessible point, enables the user to set all the adjustment and control parameters using a simple sequence of digital commands with the keys on the front. A monitor displays and confirms all the operations performed; the power unit, installed inside the panel, is an electronic circuit board that serves to drive the utilities on the basis of the parameters and configuration set by the operator on the console.

On it, the following elements are readily identifiable:

- the control keyboard, used to set the operating parameters
- the display, used to view the settings, room temperature, fan status and, after entering the parameter editing section, any alarm codes.

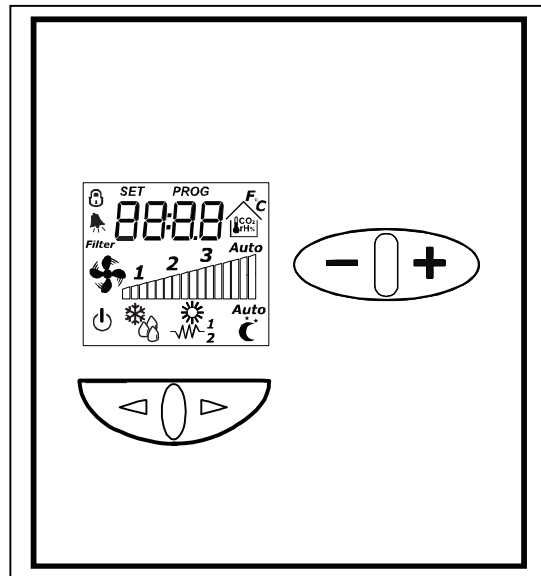

LCD remote control

LCD terminal

The LCD terminal, equipped with a liquid crystal display, two keys for mode selection, two for selection of the set and serial communication line and two wires with power supply for communication with the control unit, is a good example of simplicity, economy and synthesis of the main functions.

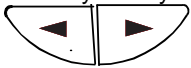
Using the  keys, you can set the different adjustment functions, view the alarms and edit the main

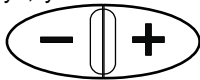













adjustment settings, while the  keys will serve to edit the setting and parameters in the different functions.

Type of key pressure

- Brief pressure : $T < 1$ s
- Medium pressure : $1 < T < 3$ s
- Long pressure : $3 < T < 5$ s
- Constant pressure : $T > 7$ s

Description of symbols on LCD version

The following is a list and description of the main symbols on the display. For the relative functions and set points, see the relative paragraphs.

Symbol	Name	Function
	ON/OFF	Switches the unit on/off. If there is a digital ON/OFF remote control it can be inhibited or take priority
	COLD	Cooling mode
	WARM	Heating mode
	AUTO FILTER	Automatic mode Dirty filter warning
	FAN	Fan mode
	SPEED	Fan speed selection (1 = minimum, 2 = medium, 3 = maximum, Auto = automatic)
	SPEED BAR	Continuous fan speed selection with current level indication
	TEMPERATURE	Temperature symbol, on when data is read on display, indicates sensor temperature reading
	SET	Parameter setting mode
	PROG	Parameter editing mode
	ALARM	Alarm activates in control unit, visible by pressing any key
	ELECTRIC HEATER	Electric heating mode on or defrost mode by fan or antifreeze mode
	UNIT	Fahrenheit / Centigrade degrees
	HOUSE	Symbol representing the indoor reading of the variable indicated, which may be temperature or air quality
	CO2	Indication of reading of air quality sensor

Control circuit

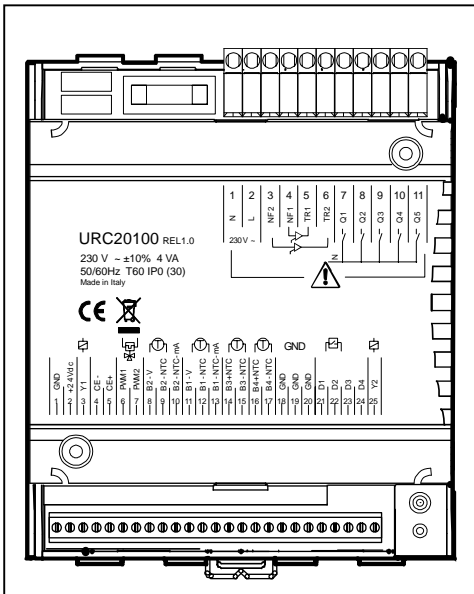

Power circuit

IO list: electric data

The following is the table of IO with electric data for every input and output. The default configuration values relative to the model are specified hereafter in the chapter

High voltage terminal board

Working environment range = 0 .. 40 °C, maximum current 3 A for each Triac with box CLOSED and external filter.

Working environment range = 0 .. 40 °C, maximum current 6 A for each Triac with box OPEN and external filter.

Class of protection = IP00 (IP30 with additional protection)

#	ID	Description	Electric characteristics (at nominal voltage)
1	N	Neutral supply	230 V AC +10%, -15 % at 50 Hz. max Absorption 8 VA (without additional loads)
2	L	Power line	
3	NF2	Reference TR2	Connected to N
4	NF1	Reference TR1	Connected to N
5	TR1	Triac 1 output	
6	TR2	Triac 2 output	
7	Q1	Digital outputs 1	
8	Q2	Digital outputs 2	
9	Q3	Digital outputs 3	
10	Q4	Digital outputs 4	
11	Q5	Digital outputs 5	

Low voltage terminal board

#	ID	Description	Electric characteristics (at nominal voltage)
1	GND	Reference	Reference
2	+24Vdc	Service output 24 V DC	24V DC + 50%, -20% with max ripple = 0,8V Max. output current = 10 mA
3	Y1	Outputs 0..10 V DC	
4	CE-	URT connection	Connecting wire between terminal unit and control circuit. Pay attention to the polarity if you connect several control circuits in MASTER – SLAVE configurations
5	CE+	URT connection	Connecting wire between terminal unit and control circuit. Pay attention to the polarity if you connect several control circuits in MASTER – SLAVE configurations
6	PWM1	Not used	Not connected
7	PWM2	Not used	Not connected
8	B2-V	Multiple analogue input 2	
9	B2-NTC		
10	B2-NTC-mA		
11	B1-V	Multiple analogue input 1	
12	B1-NTC		
13	B1-NTC-mA		
14	B3-NTC	NTC input	
15	B3-NTC		
16	B4-NTC	NTC input	
17	B4-NTC		
18	GND	Reference	
19	GND		
20	GND		
21	D1	Digital inputs 1	
22	D2		
23	D3		
24	D4		
25	Y2	Outputs 0..10 V DC	

Notes for multiple analogue inputs

To use the multiple analogue inputs correctly, in addition to configuring the input features of the relative parameters, via software, it is necessary to position the corresponding jumper correctly.

The Jumper JP1 refers to multiple analogue input B1 (terminals 11, 12 and 13)

Jumper JP2 refers to multiple analogue input B2 (terminals 8, 9 and 10)

To correctly configure reading of the ntc and probes with outputs 0 .. 10 V, it is necessary to position the jumpers between the respective terminals 1-2

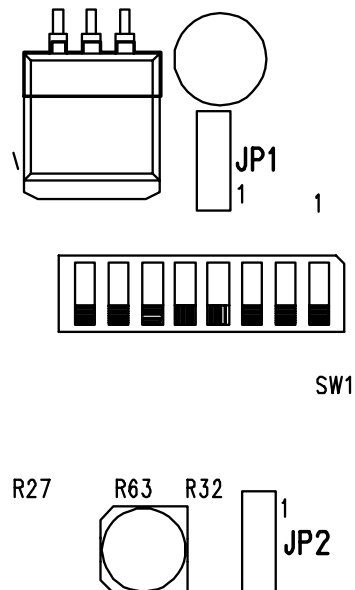

2. General Functions

General parameters

The inputs of the board that serve for serial communication in case of Slave model, must be configured on the first three dip switches of the board, to set the address from number 0 to number 7. In particular, if there are expansions, the same address must be set as on the URC slave "father".

Dip 1, bit MSB, bit 3 LSB, as shown in the table below :

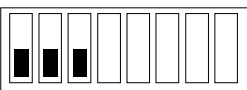
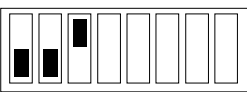
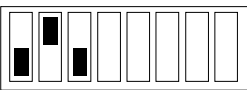
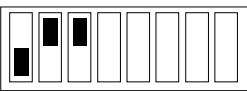
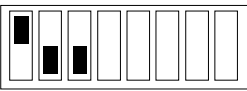
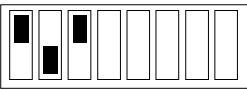
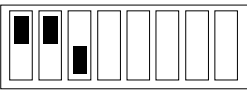
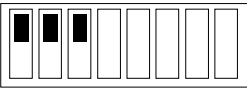
Dip switches	Configuration	Mod.	#	Description
1 / 2 / 3	1 2 3 4 5 6 7 8 ON  OFF	000xxxxx	0	Communication serial address 0
	1 2 3 4 5 6 7 8 ON  OFF	001xxxxx	1	Communication serial address 1
	1 2 3 4 5 6 7 8 ON  OFF	010xxxxx	2	Communication serial address 2
	1 2 3 4 5 6 7 8 ON  OFF	011xxxxx	3	Communication serial address 3
	1 2 3 4 5 6 7 8 ON  OFF	100xxxxx	4	Communication serial address 4
	1 2 3 4 5 6 7 8 ON  OFF	101xxxxx	5	Communication serial address 5
	1 2 3 4 5 6 7 8 ON  OFF	110xxxxx	6	Communication serial address 6
	1 2 3 4 5 6 7 8 ON  OFF	111xxxxx	7	Communication serial address 7

Terminal connection network - controls

Electric connections

For connection of the terminals to the control or control network, bipolar sheathed and twisted AWG 20 –22 wires must be fastened to the relative terminals indicated on the terminal board and control.

In connections between SLAVES, the polarity of the connections must be checked to ensure communication.

The maximum distance of the terminal from the relative control is 30m.

The maximum distance between controls is 50m.

The supply voltage is 24 V DC with data transmission on double connection with packets at a transmission speed of 4800 bit/s and proprietary protocol.

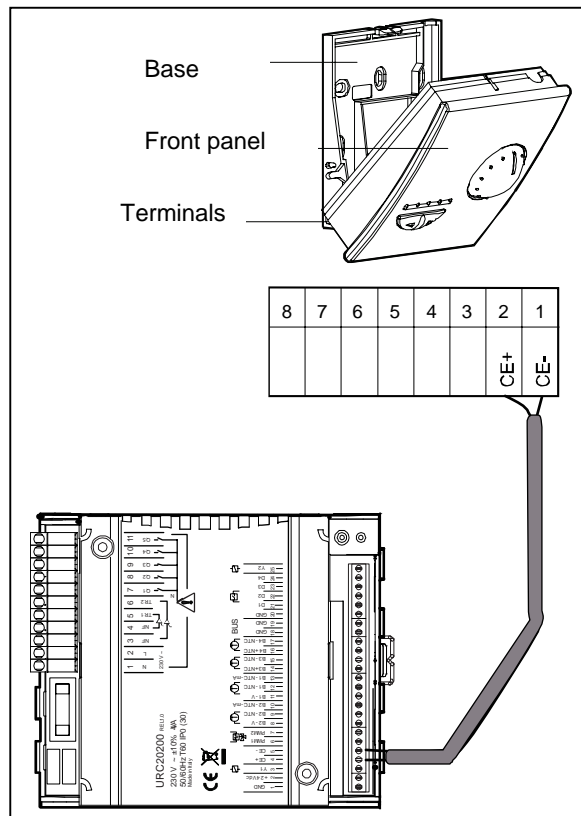

Network configuration

A simple network can consist of :

1. an LCD terminal, with the functions of MASTER of the network combined with one of the following configurations:
 - a. with 1 control slave
 - b. with 1 control slave and relative expansion,

The extended network can consist of :

2. an LCD terminal, with the functions of MASTER of the network combined with one of the following configurations:
 - a. with a maximum of 8 control slaves with the same type of adjustment.
 - b. 4 control slaves with relative expansions, configured as 4 machines with the same type of adjustment.

When switched on, the terminal checks the network present and takes care to align the memories of all the controls. The addresses of the circuit board must all be different in the network with 8 controls, while in the version with expansions, the address will be that of the machine, differentiated in the lower part between the control board and the expansion.

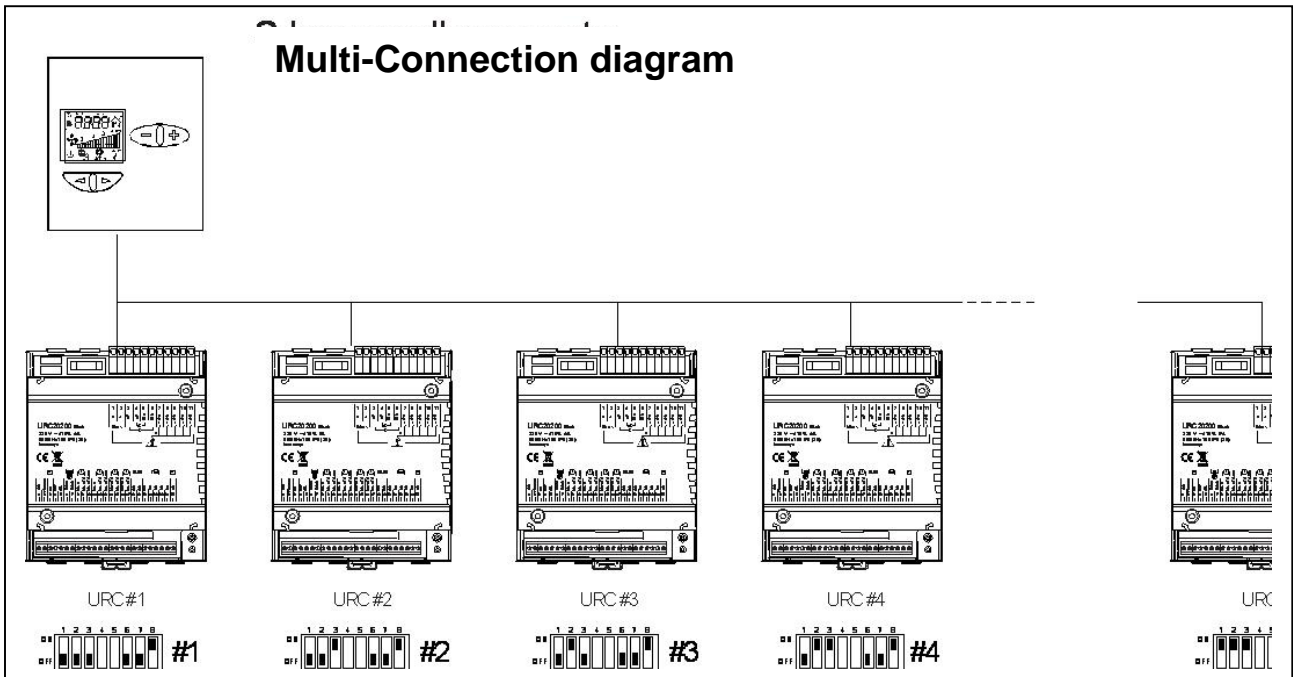

Switching ON sequence

When switched on, the led on the circuit board blinks slowly for about 2 s (0.5 s ON and 0.5 s OFF), then more rapidly (0.2 s ON and 0.3 s OFF) and the control moves into a “dialogue” stage with the terminal connected, where there is an exchange of data. This stage can last as long as 20 sec when the network is extended. At the end of this stage, the control places itself on stand-by where the led remains on unless errors are found on the analogue inputs (otherwise it continues blinking slowly 1.5 s ON and 0.5 s OFF). If after the dialogue stage there are errors of network connection, the relative error will be displayed on the terminal. Otherwise, if the mode selected on the dipswitches does not call for the presence of the terminal, the dialogue stage lasts only 5 s and then the control goes on stand-by.

Description of the main functions



For some configurations set on the control, certain actions may not be available

First startup

When the unit is switched on for the first time, the display lights all the symbols for about 2 s, then lights only the BLOCK and a lower case R is displayed on the figures, followed by the number of the terminal software release. After that, the number of circuit boards connected to the network is displayed (controls + expansions). During this time there is an exchange of initialization data with the control. This stage can last up to 20 s. If at the end of this stage the terminal displays the room temperature with the unit of measure, the HOUSE and the ON/OFF symbol, it means transmission of the initialization protocol is complete and the terminal and control are on stand-by. If after the initialization sequence the message Er starts flashing on the screen, followed by two figures and the alarm symbol, it means the initial transmission has failed. In this case it is not possible to use the control.

Stand By Mode

In Stand by mode, the terminal displays the room temperature with the HOUSE symbol, the unit of measure and the ON/OFF symbol



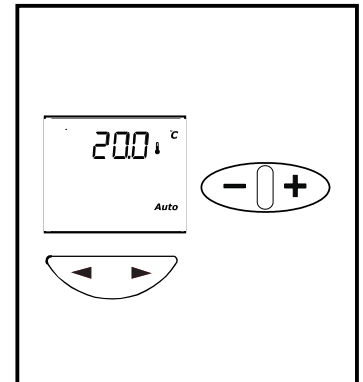

Key	Action	Function
	Brief pressure	Passage to: Auto mode if first startup or prior to switching off
	Long pressure	Activation: Edit Set by installer



Automatic Mode

In Automatic Mode, the terminal displays the room temperature with the unit of measurement and the HOUSE, the AUTO symbol and the speed bar setting. In this way the control performs the enabled adjustments associated with the Automatic Mode



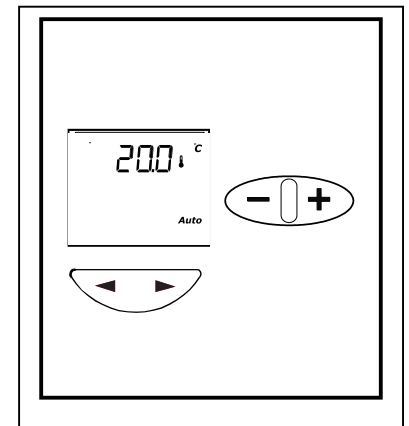

Pressing the Increase and Decrease keys activates the auto set editing mode, indicated with the word SET and disappearance of the HOUSE symbol. After a few seconds, if you do not edit anything, the display returns to normal mode.

Key	Action	Function
	Brief pressure	Passage to: Cooling mode
	Medium pressure	Passage to: Speed setting
	Medium pressure	Passage to: Stand By
	Brief pressure	Single increase of Auto set adjustment
	Medium pressure	Rapid increase of Auto set adjustment
	Brief pressure	Single decrease of Auto set adjustment
	Medium pressure	Rapid decrease of Auto set adjustment



Cooling mode



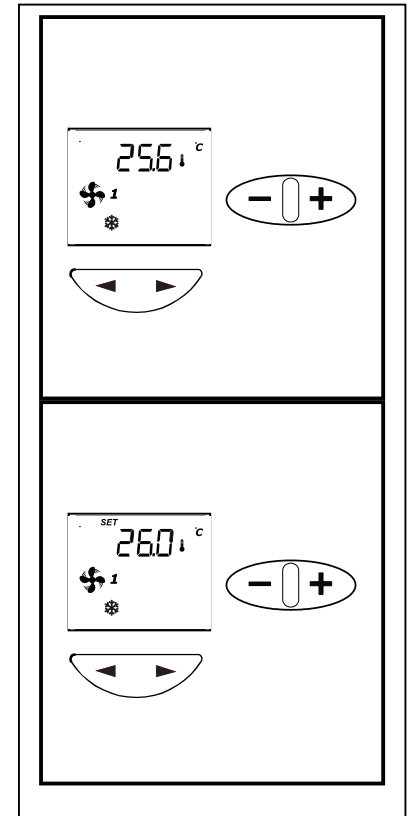

With respect to the Automatic mode, on the display the word AUTO disappears and the COLD symbol appears. The rest of the display and commands remains the same as in Automatic mode

Key	Action	Function
	Brief pressure	Passage to: Heating mode
	Medium pressure	Passage to: Speed setting
	Brief pressure	Passage to: Automatic mode
	Medium pressure	Passage to: Stand By
	Brief pressure	Single increase of Cold set adjustment
	Medium pressure	Rapid increase of Cold set adjustment
	Brief pressure	Single decrease of Cold set adjustment
	Medium pressure	Rapid decrease of Cold set adjustment



Heating mode



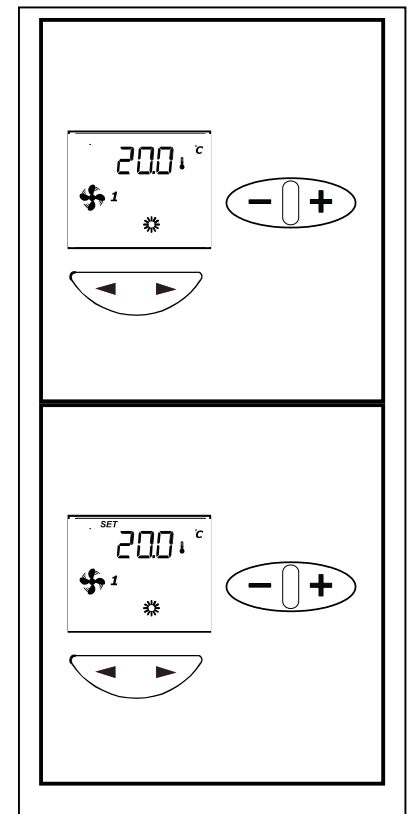

With respect to Automatic mode, the word AUTO disappears and the symbol HOT appears on the display. The rest of the display and controls remains the same as in Automatic mode

Key	Action	Function
	Brief Pressure	Passage to: Chronothermostat mode (see PROGRAMMING TIME BANDS)
	Medium Pressure	Passage to: Speed setting
	Brief Pressure	Passage to: Automatic mode
	Medium Pressure	Passage to: Stand By
	Brief Pressure	Single increase of Hot set point
	Medium Pressure	Rapid increase of Hot set point
	Brief Pressure	Single decrease of Hot set point
	Medium Pressure	Rapid decrease of Hot set point



Fan Mode

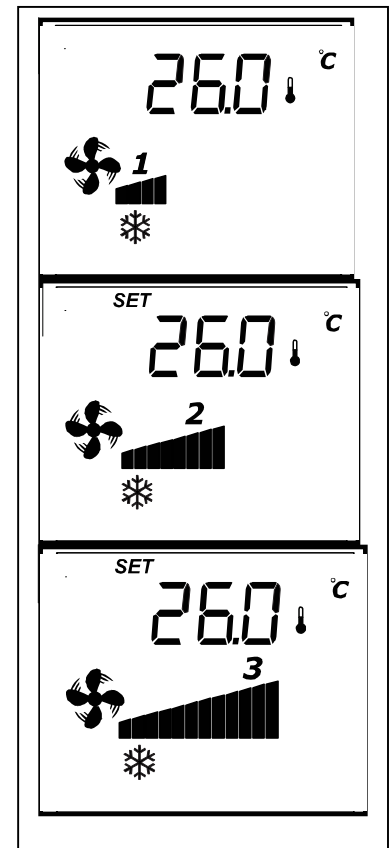

This function serves to select the fan speed. When it is selected, the indications relative to the temperature disappear and the speed bar appears, with the FAN symbol blinking. The percentage set for the fan is indicated as V1, V2 or V3. Every time the right arrow is pressed, the next speed is selected, in order: V1 - V2 - V3 - VAUTO - V1 again, with adjustment of the bar, the speed number and value set. In this mode there is a timer that takes the terminal back to "previous mode" after about 20 seconds, if no more keys are pressed.

Key	Action	Function
	Brief Pressure	Passage to: next speed
	Brief Pressure	Passage to: previous mode
	Brief Pressure	Single increase of speed setting
	Medium Pressure	Rapid increase of speed setting
	Brief Pressure	Single decrease of speed setting
	Medium Pressure	Rapid decrease of speed setting





Installer Mode Level Setting



In this function the word SET is displayed fixed. The terminal maintains control on Stand-by and some of the regulation parameters can be edited. In this mode there is a timer that takes the terminal to Stand by mode after about 2 min if no key is pressed

Key	Action	Function
	Brief Pressure	Passage to: Parameter regulation
	Long Pressure	Passage to: Stand by

Parameter Setting Mode

In this function the word SET remains and the letter P appears, followed by a number with three figures representing the parameter to edit. Not all the parameters appear and can be edited. The editing sequence is described with the sequence of the following actions

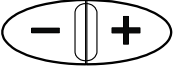
1. With brief pressure of one of the  keys, select the parameter to edit (the consecutive number varies. NOTE: not all parameters are available)
2. With brief pressure of the  key you enter the effective regulation mode, and the word PROG appears, with the effective setting, as well as the unit of measurement, if available.

- By pressing the  key you can increase or decrease the setting (each brief pressure corresponds to one variation, constant pressure permits rapid variation)
- Confirm the value with brief pressure of the  key. The display returns to indicate the consecutive number of the parameter preceded by the letter P.

The reference of the number to edit is found in column # of the tables of parameters in the section of the relative functions

Permanent Alarm Reset Mode



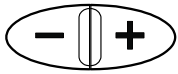

In this function, all the standard functions are shown on the display, plus the ALARM ON symbol .

- To view which of the permanent alarms is in progress, from the Stand-by status, press and hold the



keys. The list of permanent alarms is shown below:

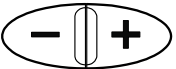



- 1 = supply fan protection mode
- 2 = return fan protection mode
- 3 = electric heater protection mode

- To view on which slave the permanent alarm occurred, press 
- After viewing on which of the slaves the permanent alarm occurred, press  or 
- To reset the permanent alarm displayed, press and hold 
- To exit this menu, press 

Sensor Value Display Mode

This mode serves to display the value read on one of the probes set on the control or expansion, or the software release on the control.

To access this function :

- Place the terminal in (**Auto**) mode;
- Press and hold the  keys; all the symbols appear on the display as well as the letter C, followed by the address of the control selected, and the letter P followed by the number of the probe selected;
- Press  once to select the address of the control on which you wish to view the probe value (you can only select the addresses present in the network). To view a probe connected to an expansion, select the address of the relative control to which the expansion is connected;
- By pressing  once, select the desired probe (see the table below);
- press  once to return to normal function.

To view the value of a probe, it is necessary to connect it and set the relative input for programming the parameters. If you try to view a probe that is not present or not set, the value 0 will be displayed.

<i>Value set</i>	<i>Corresponding sensor</i>
0	Room temperature sensor (inside the control panel)
1	Air quality sensor or pressure sensor (if existing)
2	Exhaust air temperature sensor
3	Supply air temperature sensor
4	Outside air temperature sensor
5	Not used
6	Not used
7	Not used
8	Not used
9	Software release installed on control

3. Control logic

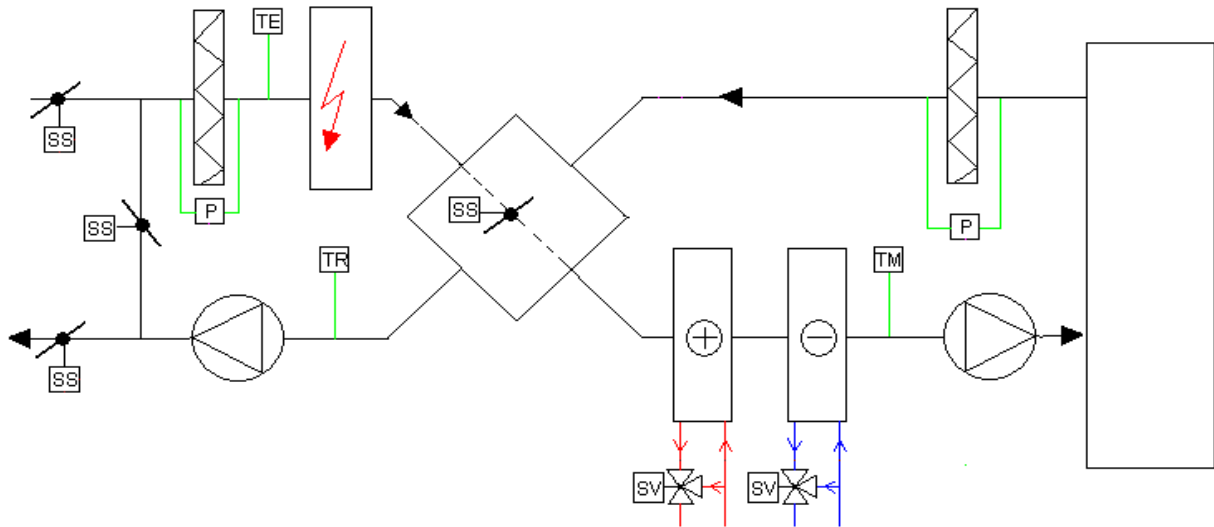

Control priorities

It is possible to set the "Control priority" parameter that indicates which of the amplitudes listed above has priority in making the adjustments that will be described hereafter.

#	Parameter	Position	Default	Range	Notes
45	Control priority	Control	0	0-1	0 Priority on temperature 1 Priority on humidity

Autostart Function

The control is equipped with an Autostart function that, in case of interruption and subsequent return of power, automatically starts the machine from the last operating state. This function is always enabled, by default, and can be disabled using a special parameter.

#	Parameter	Position	Default	Range	Notes
190	Disable Autostart	Control	0	0 .. 1	0 Autostart ON 1 Autostart disabled

Analogue inputs

#	Parameter	Position	Default	Range	Notes
54	Sensor Type ch 1 B2	Control	0		0 Not used
55	Sensor Type ch 2 B1	Control	10		1 Coil water temperature
56	Sensor Type ch 3 B3	Control	4		2 Outside temperature (antifreeze)
57	Sensor Type ch 4 B4	Control	5		3 Coil antifreeze temperature
161	Sensor Type ch 5 B6	Expansion	2		4 Supply air temperature
162	Sensor Type ch 6 B5	Expansion	0		5 Return air temperature
163	Sensor Type ch 7 B7	Expansion	0		6 Return air humidity
164	Sensor Type ch 8 B8	Expansion	0	0 .. 11	7 Supply air humidity
					8 VOC air quality
					9 CO ₂ air quality
					10 Exhaust air temperature
					11 Pressure sensor (4-20 mA signal)
					13 Pressure sensor (0-10 V signal)
58			0	-5..+5	
59			0	-5..+5	
60	Room temp. calibration [°C]		0	-5..+5	
	Outside temp.calibration [°C]				
61	Exhaust air temp.calib. [°C]		0	-5..+5	
	Calib. of air pressure [%]				
165	Coil water temp.calib. [°C]		0	-5..+5	Calibration value of sensor to compensate for any possible errors.
	Antifreeze temp.calib. [°C]				
166	Supply air temp.calib. [°C]		0	-5..+5	
167	Return humidity calibration [%]		0	-5..+5	
	Supply humidity calibration [%]				
168	VOC air quality calibration		0	-5..+5	
169	CO ₂ air quality calibration		0	-5..+5	
170			0	-5..+5	
171			0	-5..+5	

NOTE: Checks are made on the enabled analogue inputs to control the integrity of the sensor configured. If the control performs measurements attributable to a sensor breakdown, the control excludes all regulations connected to that input; moreover, if the regulations are of primary importance, the control goes into alarm status and automatically resets itself (see below the chapter relative to the digital inputs). The sensor error is signaled with a blinking led on the circuit, on 1.5 s and off 1.5 s. The error is also signaled on the terminal, if installed.

For the correct function of regulations, the type of sensor connected to the relative channel must be set. There are 4 inputs on the control and 4 on the expansion, if any, and for every channel the relative parameter “sensor Type channel x” serves to classify the sensor connected. It is not possible to configure the same type of input for different inputs. The control will consider the setting of the input with the highest consecutive number valid, while the one with the lowest number is “lost”.

The calibration value serves to correct any fixed errors on the sensor.

Control Algorithms: Temperature control

The parameters that participate in this type of regulation are listed below

#	Parameter	Position	Default	Range	Notes
3	Control sensor [C°]	Control	2	0 .. 5	0 Built-in room temperature sensor 1 Room temperature sensor 2 Supply air temperature sensor 3 ...
5	Set Point [C°]	Control	22	6 .. 32	Temperature Set Point in AUTOMATIC mode
10	Hot Set Point [C°]	Control	22	15 .. 45	Temperature Set Point on Heating mode
63	Hot Hysteresis [C°]	Control	1	0,5 .. 5	Hysteresis band for activation of Heating mode

#	Parameter	Position	Default	Range	Notes
18	Hot Neutral Zone [C°]	Control	1	0,5 .. 5	Hysteresis band for Hot Neutral Zone of intervention around temperature Set Point, in automatic function
21	Cold Set Point [C°]	Control	22	5 .. 35	Temperature Set Point in Cooling mode
62	Cold Hysteresis [C°]	Control	1	0,5 .. 5	Hysteresis band for activation in Cooling mode
19	Cold Neutral Zone [C°]	Control	1	0,5 .. 5	Hysteresis band for Cold Neutral zone of intervention around temperature Set Point in Automatic mode

Heating/Cooling Functions

The temperature control function uses a temperature sensor that must be set on the parameter "control sensor". After setting the sensor, the controller works in direct or reverse logic depending on the function mode set on the HOT or COLD position, enabling the relative "Request of Heating" or "Request of Cooling" with a hysteresis around the temperature set point shown in the paragraphs indicated above, as shown alongside.

More details about how the "heating request" or "cooling request" are made can be found in the chapter relative to the output management algorithms

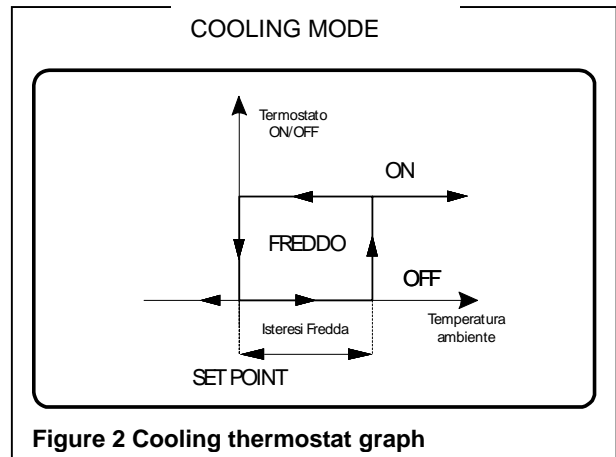
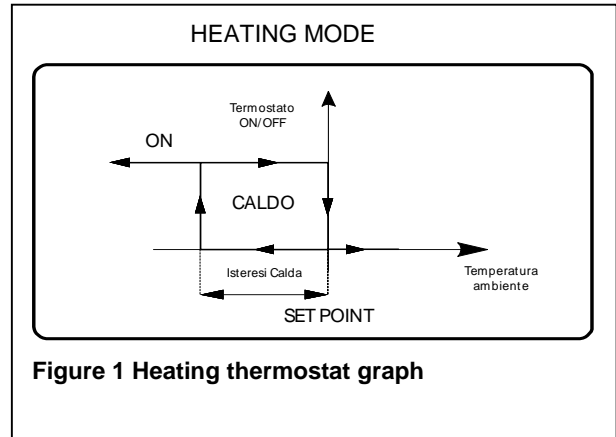

Automatic function (from control panel)

When setting the control with the automatic function, in 2/4 pipe systems, the functions used are those of the automatic change of control logic depending on the temperature change of control logic depending on the temperature value read by the sensor specified in the parameter "control sensor".

The controller changes the logic by comparing the value read by the sensor with the set point and enabling the relative "Request of Heating" or "Request of Cooling", as shown in the graph alongside.

More details about the "Request of Heating" or "Request of Cooling" can be found in the chapter on output management algorithms.

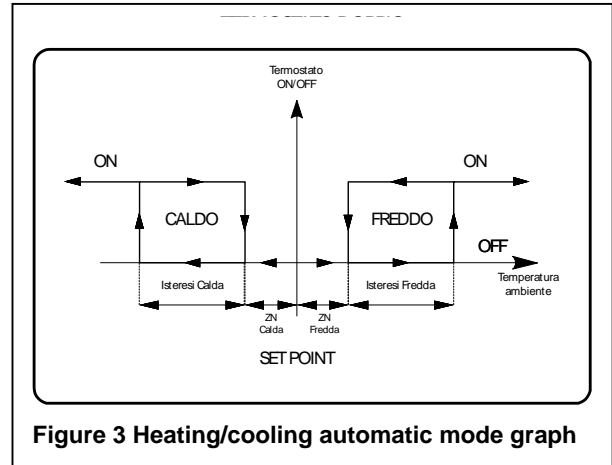

Figure 3 Heating/cooling automatic mode graph

Algorithm for Defrost mode

#	Parameter	Position	Default	Range	Notes
112	Defrost control	Control	0	0 .. 3	0 No control Control by electric heater and/or mixing box 1 3 Control by fan
8	Set Point for defrost with outside air sensor [°C]	Control	5	0 .. 15	Function setting for defrosting function recovery package when the outside air sensor is selected for defrosting
138	Defrost sensor	Control	0	0 .. 1	0 = outside air sensor 1 = exhaust air sensor
242	Set Point for defrost with exhaust air sensor [°C]	Control	0	-20 .. 5	Function setting for defrosting function recover package when the exhaust air sensor is selected for defrosting
75	RG hysteresis for defrost [°C]	Control	1	0 .. 5	Hysteresis for activation of electric heater
77	Minimum defrost time [s]	Control	30	0 .. 300	Minimum activation time of the output after verifying the temperature conditions of the defrost sensor. If set at 0, it is disabled
79	Maximum defrost time [s]	Control	60	0 .. 300	Maximum activation time of the output after verifying the temperature conditions of the defrost sensor. If set at 0, it is disabled
81	Time between one defrost cycle and another [m]	Control	10	0 .. 300	Time that must pass between defrostings

Defrost control by electric heater or mixing box

If you select the defrosting function by electric heater or mixing box, after setting the temperature sensor on the parameter "sensor type channel x", as exhaust temperature sensor, and the parameter 138 (defrost sensor) on value 1 (exhaust sensor), the controller enables the defrosting function and verifies the value of the temperature sensor, to control the defrosting conditions.

If the conditions are correct, the controller activates the electric heater output, until the temperature reaches a point higher than the "Defrosting Set Point with exhaust sensor (242)".

The duration of operation of the electric heater is regulated by the parameters "Minimum defrost time", "Maximum defrost time" and "Time between defrost cycles".

If the electric heater is switched off (on reaching the temperature conditions or after selection of stand-by status from a remote terminal), a post ventilation time of 40 s is maintained to prevent overheating due to thermal inertia.

NOTE: With defrosting management via electric heater of the ON/OFF type, the driven electric heater must be connected to the digital output "Defrost Control of electric heater 1".

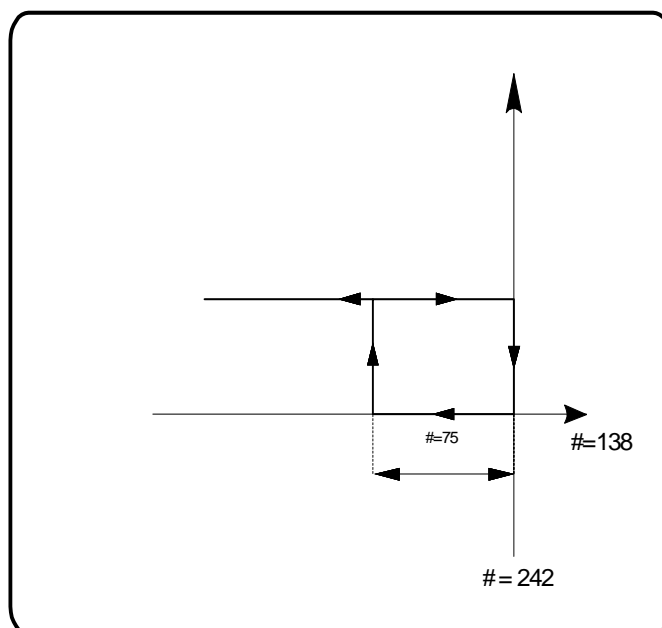

Figure 4 Graph of defrost mode by electric heater

Antifreeze Mode

This is enabled with parameter 240 (“Enable Antifreeze”) and is recognized by the controller when the supply air temperature sensor falls below the value of the settable parameter 241 “Set Antifreeze”. In this case, the control lights the antifreeze symbol on the display, shuts off the fan, closes outside air & exhaust air dampers and fully opens the valve (if installed) of water heating coil; normal operation is restored only when the supply air temperature once again exceeds the parameter value.

#	Parameter	Position	Default	Range	Notes
240	Enable antifreeze	Control	0	0 .. 1	0 = disabled 1 = enabled
241	Set Antifreeze [°C]	Control	0	-5 .. +5	Setpoint for to enable antifreeze protection

Algorithm for outside air temperature

Compensation of setting

#	Parameter	Position	Default	Range	Notes
30	SET POINT for start of summer compensation [°C]	Control	27	10 .. 35	Final value of setting modified by summer compensation
31	Summer compensation delta [°C]	Control	5	0 .. 10	Delta of correct of summer work setting
32	Summer compensation band [°C]	Control	5	0 .. 10	Correction band with respect to outside summer temperature
34	SET POINT for start of winter compensation [°C]	Control	0	0 .. 15	Final setting modified by winter compensation
35	Winter compensation delta [°C]	Control	5	0 .. 10	Delta of correct winter work setting
36	Winter compensation band [°C]	Control	5	0 .. 10	Correction band with respect to outside winter temperature

The compensation set point ensures greater comfort when the regulation temperature values (or those of the outside temperature) are particularly extreme with respect to the needs of the controlled environment.

The compensation adds (or subtracts) a “delta” value from the setting. This depends on the outside temperature sensor with which the compensation is made.

If the sensor for compensation is not selected, compensation will be disabled. With the outside sensor enabled, to disable compensation just reset the regulation delta

The graph below shows the curve obtained by compensating the regulation set point with the outside temperature sensor.

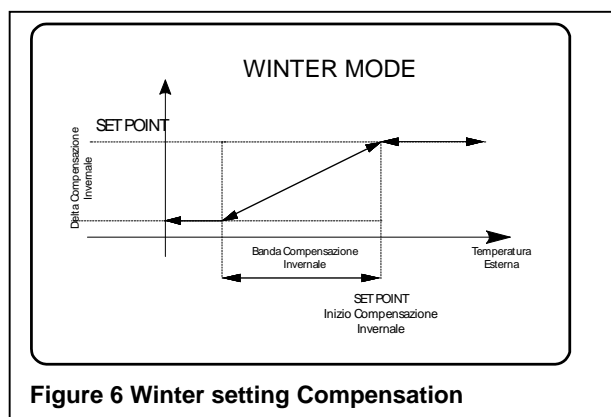
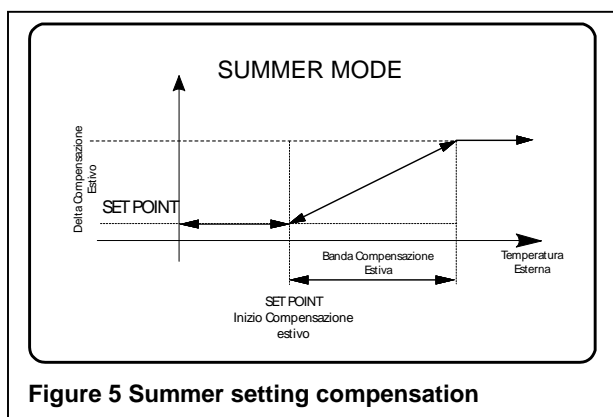

Free cooling (heat recovery by-pass)

#	Parameter	Position	Default	Range	Note
15	Free cooling differential[°C]	Control	3	0...10	Differential between external and internal temperature, for activation of the free cooling function.
134	Total By-pass	Control	1	0 .. 1	Enable total by-pass

After activating the outside air temperature sensor in the parameter relative to the type of channel sensor, the controller verifies, by reading the control sensor, whether the temperature conditions compared with the outside temperature permit exclusion of heat recovery for purposes of climate regulation.

The by-pass damper can be manage in two different, selectable ways:

Total by-pass (Total By-pass = 1) : when the by-pass is in function it will have priority and no other device must be on (water valves for instance) even if required by the room setpoint.

Partial by-pass (Total By-pass = 0) : when enabled, other devices can be on at the same time depending on the requirements of the room setpoint.

The function is managed by the control and outside temperature sensor and activates an ON/OFF servomotor:

By-pass open (heat recovery off): the following conditions must all be satisfied

- Outside air temperature < control temperature – Free cooling differential
- Outside air temperature > 15°C
- Room air temperature > 22°C

By-pass closed (heat recovery on): at least one of the following conditions must be satisfied

- Outside air temperature > control temperature
- Outside air temperature < 14°C
- Room air temperature < 20°C

Algorithm for supply air temperature

#	Parameter	Position	Default	Range	Notes
38	Maximum upper limit of supply air temperature [°C]	Control	40	15 .. 60	Upper limit of supply air temperature (heating mode)
40	Maximum lower limit of supply air temperature [°C]	Control	10	8 .. 60	Lower limit of supply air temperature (cooling mode)
42	Upper differential [°C]	Control	8	1 .. 30	Compensation differential (heating mode)
44	Lower differential [°C]	Control	8	1 .. 30	Compensation differential (cooling mode)

The supply air temperature sensor controls the heating or cooling action to compare the supply air temperature limit with a specific setting, and thereby limits the thermal actions to prevent unpleasant sensations of air that is too hot or too cold.

The controller verifies the temperature read by the supply air sensor and compensates the action on the heating or cooling organ in function at the moment, to limit its action. The position of the valve is reduced by the calculated value to reduce the heating effect (see graphs below), contrasting the request of hot/cold air that induced the limiting intervention.

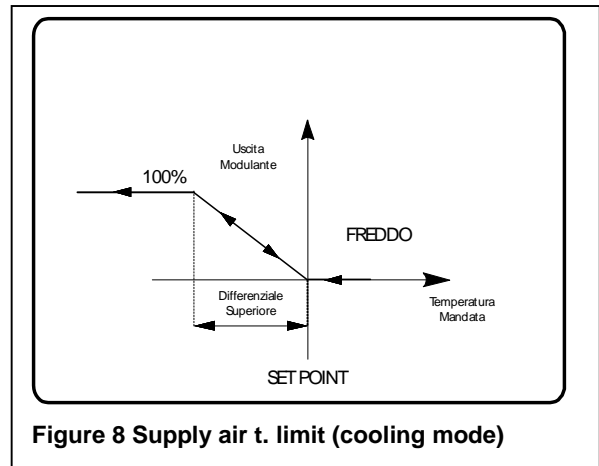
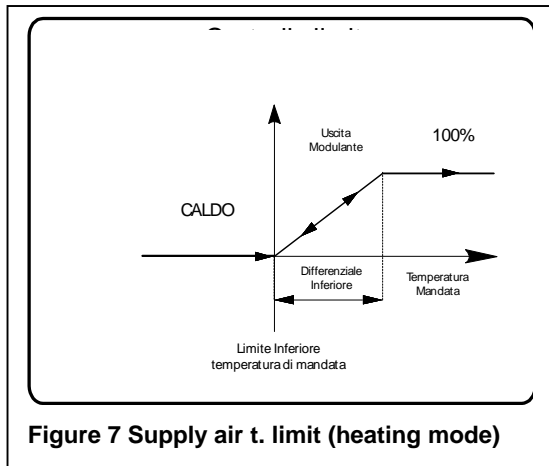

In case of ON/OFF valve control, the compensation works in accordance with the following graphs.

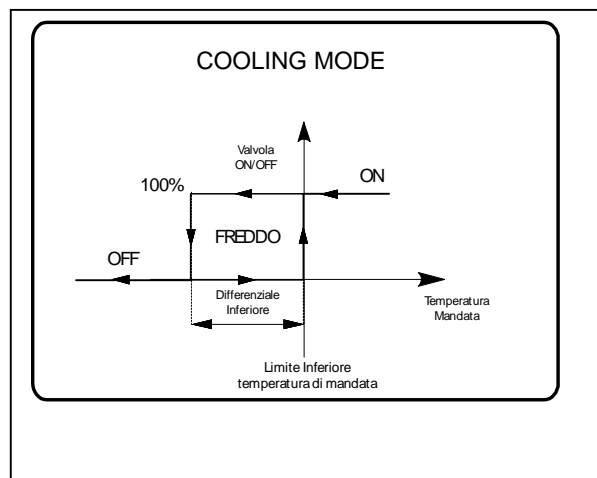
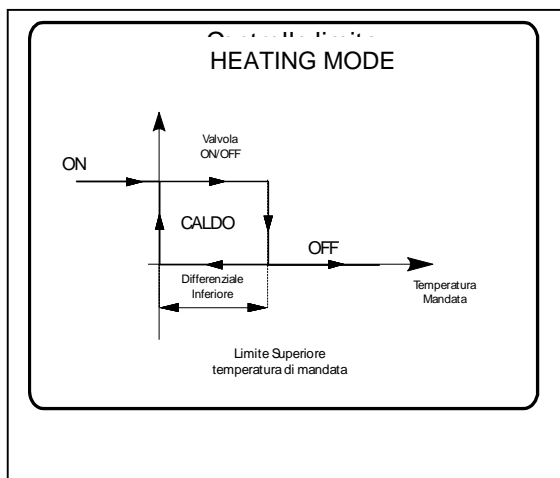

Control of water valve(s) and electric heater(s)

#	Parameter	Position	Default	Range	Note
102	System type	Control	0	0 .. 6	0 No added load 1 Changeover coil water valve 2 Changeover coil water valve and additional electric heater 3 Cooling coil water valve and electric heater 4 Cooling coil water valve, electric heater 1 and electric heater 2 5 Heating coil and cooling coil water valves 6 Heating coil and cooling coil water valves and additional electric heater
103	Type of cold valve/changeover valve	Control	1	0 .. 2	0 No valve 1 ON-OFF valve 2 Modulating valve with signal 0 -10V / 3-position valve
104	Type of hot valve	Control	1	0 .. 2	0 No valve 1 ON-OFF valve 2 Modulating valve with signal 0 -10V / 3-position valve
108	Valve opening time (s)	Control	180	0 .. 255	Time to fully open 3-position valve

System type:

- Changeover valve: the implementation described in paragraph "Temperature control" will be carried out only on the changeover valve present.
- Changeover valve and additional electric heater: the implementation is made on the changeover valve to satisfy the cooling and heating demands and on the integrating parts to integrate the demand for heating.
- Cold valve and additional electric heater: the implementation is made on the cold valve to satisfy demands for cooling and on the electric heater to satisfy the demand for heating.
- Hot Valve and cold Valve: the implementation is made on the cold valve to satisfy the demands for cooling and on the hot valve to satisfy the demand for heating.
- Hot Valve and cold Valve and additional electric heater: the implementation is made on the cold valve to satisfy cooling demands and on the hot valve to satisfy the heating demand on the parts for integration, and to integrate the demand for heating.

Control of minimum/maximum supply air temperature

Heating Mode

#	Parameter	Position	Default	Range	Notes
246	Lower supply air temperature limit on heating mode [°C]	Control	10	8 .. 60	
42	Upper differential [°C]	Control	8	1 .. 30	Hysteresis on heating mode

On heating mode, this function limits the minimum supply air temperature by acting on the heating elements so as to prevent unpleasant sensations due to the arrival of cold air in the room. To use it, the supply air temperature sensor must be enabled with the setting of parameter "246" and "42".

Cooling Mode

#	Parameter	Position	Default	Range	Notes
244	Upper supply air temperature limit on cooling mode [°C]	Control	40	15 .. 60	
44	Lower differential [°C]	Control	8	1 .. 30	Hysteresis on cooling mode

On cooling mode, this function limits the maximum supply air temperature, by acting on the cooling elements so as to prevent unpleasant sensations due to the arrival of hot air in the room. To activate it, the supply air temperature sensor must be enabled with setting of parameter "244" and "44".

Winter heating speed-up mode (by time)

This mode keeps outside air and exhaust air dampers closed (and recirculated air damper open) for a time according to parameter "150" at starting. After this time, the normal damper working mode is restored.

#	Parameter	Position	Default	Range	Notes
150	Winter start [min]	Control	0	0 .. 255	Delay time on Winter start mode

Supply/Return Fan Mode

#	Parameter	Default	Range	Description
92	Fan function mode	0	0-5	0 Fan always on with machine ON/OFF
				1 Thermostat fan
				2 ...

After checking the settings of the parameter on the function mode, the controller activates delivery and return fan in accordance with the settings:

- 0 The fans are started when the machine is in the ON status and are switched off in case of permanent alarm or when the machine is OFF.
- 1 After switching the unit ON, the fans are on when the thermostat request is on, and are switched off for a permanent alarm or when the unit is off or the thermostat no longer requires any action. **With this configuration the control sensor must be the room sensor for optimum control**
- 2 ...

It is possible to configure 3 digital outputs for the 3 fan speeds, that are then set on the terminal.

Automatic fan speed control

Other functions are described in the section for modulating fan outputs.

#	Parameter	Default	Range	Description
93	Hysteresis Fan1 Cold	1°C	0 – 5°	Hysteresis of fan on first speed in automatic ventilation mode in the cold function mode
94	Delta Fan 1 Cold	2,5 °C	0 – 5°	Delta for the fan step in the second speed in automatic ventilation in cold function mode
95	Hysteresis Fan2 Cold	1°C	0 – 5°	Hysteresis of fan on second speed in automatic ventilation mode in the cold function mode
96	Delta Fan 2 Cold	4,5 °C	0 – 5°	Delta for the fan step in the third speed in automatic ventilation in cold function mode
97	Hysteresis Fan3 Cold	2°C	0 – 5°	Hysteresis of fan on third speed in automatic ventilation mode in the cold function mode
98	Hysteresis Fan1 Hot	1°C	0 – 5°	Hysteresis of fan on first speed in automatic ventilation mode in the hot function mode
153	Delta Fan 1 Hot	2,5 °C	0 – 5°	Delta for the fan step in the second speed in automatic ventilation in hot function mode
154	Hysteresis Fan2 Hot	1°C	0 – 5°	Hysteresis of fan on second speed in automatic ventilation mode in the hot function mode
155	Delta Fan 2 Hot	4,5 °C	0 – 5°	Delta for the fan step in the third speed in automatic ventilation in hot function mode
156	Hysteresis Fan3 Hot	2°C	0 – 5°	Hysteresis of fan on third speed in automatic ventilation mode in the hot function mode

Airflow control by air quality sensor (inverter driven fans only)

Air quality can be requested by VOC or CO2 and acts on the fan speed to maintain the quality of the air in accordance with the settings and graph alongside. The air is treated in any case, before being supplied into the room. The supply air temperature limit is always respected. If control is enabled by both sensors, VOC+CO2, the speed is controlled by the greater of the two signals. Entering the control parameters is made in percentage with respect to the range of measurement of the sensor.

Of course. The unequal values must be satisfied

1. "Air quality OFF setting" < "Minimum air quality setting"
2. "Minimum air quality setting" < "Maximum air quality setting"

If inequality no. 1 is not satisfied, "Air quality OFF setting" = 0 %
 If inequality no. 2 is not satisfied, "Max fan speed for air quality" = 100 %

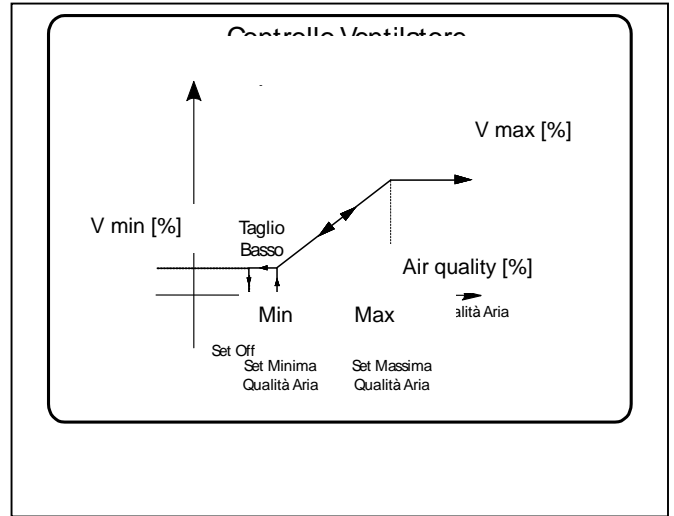

#	Parameter	Default	Range	Description
143	Airflow control	0	0 .. 3	0 Manual 2 Air quality sensor
144	Minimum air quality setting [%]	10	0 .. 100	Minimum air quality for airflow control
145	Maximum air quality setting [%]	50	0 .. 100	Maximum air quality for airflow control
146	Air quality OFF setting [%]	0	0 .. 100	Off setting for fans during air quality control

Airflow control by pressure sensor (inverter driven fans only) (constant pressure mode)

On this mode of airflow control, a pressure set point must be set and the controller acts on fan inverters so that the set point is kept.

It also needs "Kp" and "Ti" parameter setting, they are used to adjust the PID formula.

The parameters related to this mode are the following :

#	Parameter	Position	Default	Range	Note
143	Airflow control	Control	0	0 .. 3	0 Manual 3 Pressure sensor
14	Overpressure percentage	Control	100	60 .. 140	Supply fan signal compared to return fan signal [%]
25	Kp	Control	10	0 .. 100	Proportional constant
26	Ti	Control	50	0 .. 100	Integral time
27	Pressure set point	Control	100	10 .. 100	[%] of the range of sensor signal
147	Min fan signal output	Control	1	1 .. 100	Min value [%] for fan signal
149	Max fan signal output	Control	100	1 .. 100	Max value [%] for fan signal

Digital inputs

Configuration and meaning of input logic

#	Parameter	Position	Default	Range	Note
123	Digital Logic Input D1	Control	0		
124	Digital Logic Input D2	Control	0		
125	Digital Logic Input D3	Control	0		0
126	Digital Logic Input D4	Control	0	0 .. 1	
177	Digital Logic Input D5	Expansion	0		0
178	Digital Logic Input D6	Expansion	0		1
179	Digital Logic Input D7	Expansion	0		
180	Digital Logic Input D8	Expansion	0		
					0
					1
					2
					3
127	Digital Input Type D1	Control	0		4
128	Digital Input Type D2	Control	0		5
129	Digital Input Type D3	Control	0		6
130	Digital Input Type D4	Control	0	0 .. 14	7
181	Digital Input Type D5	Expansion	0		8
182	Digital Input Type D6	Expansion	0		
183	Digital Input Type D7	Expansion	0		
184	Digital Input Type D8	Expansion	0		
					13

The digital inputs, in addition to the function inputs, may also be for alarms. In the definition of the alarms, it is necessary to distinguish among three different types :

- Permanent alarms
- Automatic resetting alarms
- Warning or prealarms

Each type requires specific actions :

- **Permanent alarm:** the regulator has to place the machine in safe conditions, then stops the fans, closes any open shutters or closes the valves, depending on the type of alarm, switches on the RED led on the terminal and stops all actions until the alarm has been reset
- **Automatic resetting alarms:** the regulator places itself in safe conditions for the machine, but if the alarm resolves itself, allows the machine to start again without waiting for the user to press the reset key. The red led on the terminal blinks or the message LCD appears. All the alarms linked to input probe malfunctions are alarms with automatic resetting.
- **Warning or prealarm:** this is a warning about a foreseeable malfunction that could cause a permanent alarm on the machine.

Fan overheat



After reading the input configured as fan overheat, the controller stops the machine and places itself in the **permanent alarm** condition.



Dirty filter

#	Parameter	Position	Default	Range	Note
131	Time between filter cleanings [h]	Control	0	0 .. 5000	Time in hours of operation for activation of the dirty filter signal. If set at zero, the function is disabled. It can be edited in 20-hour steps.

The dirty filter condition (**warning or prealarm**) can be activated in two ways, both of which can be set :

1. via Digital input
2. via special timed parameter ("131")

The parameter indicates the number of effective working hours of the filter before the alarm is displayed. By hours of effective operation is meant the time in which the machine is in one of the following operating states (**Auto**,  or ) . To activate this function, enter parameter programming mode to set parameter 131 at the value desired and follow the procedure described below:

1. go into Stand By status ();
2. press and hold  until the LCD display shows the word RSET and then it disappears (or the green maintenance led () blinks for two seconds then goes out);
3. release the key.

To reset the filter timer to the value of its parameter after cleaning or at any time, repeat the same procedure.

To set the time between filter cleanings on a machine controlled by a LED terminal, set parameter 131 using the LCD terminal, switch off the machine, switch it back on, switch the LED terminal on and perform the reset procedure.

Electric heater safety thermostat

When the input configured as electric heater overheat is read, the controller stops the machine and goes into **permanent alarm** condition, leaving the fan on to cool the heating elements for 40 seconds.

Digital outputs

Configuration and meaning of outputs

#	Parameter	Position	Default	Range	Note
83 (172)	Output type ch Q1 (Output type ch Q8)	Control (Expansion)	0	0 .. 30	0 Not used
					1 Free-cooling consent
					2 Cooling coil water valve
					3 Heating coil water valve
					4 Changeover coil water valve
					5 Electric heater 1 (defrost)
					6 Electric heater 2 (defrost)
					7 3-position valve opening (cooling)
					8 3-position valve closing (cooling)
					9 Alarm summary
					10 Not used
					11 Not used
					12 On/Off humidifer consent
					13 Min fan speed V1
					14 Med fan speed V2
					15 Max fan speed V3
					16 Not used
					17 Electric heater 1
					18 Electric heater 2
					19 Electric heater 1 (reheating)
					20 Electric heater 2 (reheating)
					21 Line output
					22 Star output
					23 Delta output
					24 Not used
					25 Not used
					26 Damper
					27 3-position valve opening (heating)
					28 3-position valve closing (heating)
					29 3-position valve opening (changeover)
					30 3-position valve opening (changeover)
84	Output type ch Q2	Control	0	0 .. 30	As above
85	Output type ch Q3	Control	0	0 .. 30	As above
86	Output type ch Q4	Control	0	0 .. 30	As above
87	Output type ch Q5	Control	0	0 .. 30	As above
88	Output type ch Q6 TR2	Control	0	0 .. 30	As above
89	Output type ch Q7 TR1	Control	0	0 .. 30	As above
173	Output type ch Q9	Expansion	0	0 .. 30	As above
174	Output type ch Q10	Expansion	0	0 .. 30	As above
175	Output type ch Q11	Expansion	0	0 .. 30	As above
176	Output type ch Q12	Expansion	0	0 .. 30	As above

4. Clock program setting

Operation

Programming time bands makes it possible to associate a program (one of the 4 previously configured) for every day of the week. The programs are:

- Program 1: Two starting times, the first from “Start time first band P1” to “Stop time first band P1” with setpoint “Set Point first band P1”, the second from “Start time second band P1” to “Stop time second band P1” with setpoint “Set Point Second band P1”; the rest of the time the unit is off (on stand-by)
- Program 2: One starting time, from “Start time band P2” to “Stop time band P2” with setpoint “Set Point band P2”; the rest of the time the unit is off (on stand-by)
- Program 3: Unit always on, with set point “Set Point Band P2”
- Program 4: Unit always off

Program settings

To set the time for starting and stopping and the set points of the programs, it is necessary to edit the relative parameters, accessible from parameter programming (see the chapter). The parameters involved in this function are described in the table below. It is also possible to choose whether to display the clock or the value of the probe selected, using the specific menu.

# param	Description	Position	Default	Range	Notes
213	Start time first band P1	Control	07:00	24h	
215	Stop time first band fascia P1	Control	13:00	24h	
217	Set point first band P1	Control	22.0°C	6..32	
219	Start time second band P1	Control	18:00	24h	
221	Stop time second band P1	Control	23:00	24h	
223	Set point second band P1	Control	22.0°C	6..32	
225	Start time band P2	Control	07:00	24h	
227	Stop time band P2	Control	23:00	24h	
229	Set point band P2	Control	22.0°C	6..32	
231	Set point band P3	Control	22.0°C	6..32	
232	Program for Sunday	Control	2	0..4	0=no program 1 = P1 2 = P2 3 = P3 4 = P4
233	Program for Monday	Control	1	0..4	
234	Program for Tuesday	Control	1	0..4	
235	Program for Wednesday	Control	1	0..4	
236	Program for Thursday	Control	1	0..4	
237	Program for Friday	Control	1	0..4	
238	Program for Saturday	Control	2	0..4	
239	View time	Control	0	0..1	0 : view probe 1 : view time

To use the PROGRAM mode (the unit functions on the basis of the daily programs selected) from AUTO mode or from

HEATING mode, press .











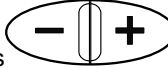

The display will show:

- The blinking symbol of the current operating mode chosen for programming (STANDBY or AUTO)
- The time (or probe) alternate to the current program (e.g.: **Pro1** if program P1 has been set for today)

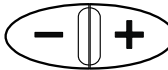
NOTE: if you go into the TIME BAND mode and have not set the clock yet, the terminal passes automatically to the clock setting time function described below.

Setting the clock

To set the clock:

- from Stand By mode, press . The current time and data appear, in the format **hh:mm** for the time and **DY:xx** where xx indicates the day (0=Sunday → 6=Saturday). The first time you set the clock after switching on, the initial indication is usually **DY:00**;
- press  to start setting the clock (minutes → hour → day → display);
- on the display you will see **mm** indicating the current minutes. Press  to regulate the minutes, then press  ;
- the display shows **hh** indicating the current hour. Press  to regulate the hour, then press  ;
- on the display you will see **DY:xx** indicating the current day (0=Sunday → 6=Saturday). Press  to regulate the day of the week, then press  ;
- the display shows **Prob** or **Hour**. Press  to choose whether to display the probe or the time, then press  to start setting the clock again, or  to save and return to the display of the current date and time;
- press  again to return to Stand By ;

5. Supervision (BMS)

For electric connections, see the specific diagram supplied with the terminal.

The protocol applied is MODBUS SLAVE RTU, which is set as follows:

- 9600 bps
- 8 data bits
- no parity
- 2 stop bits

This protocol functions with addressed management of the data by the supervisor, that interrogates each unit through the serial connection on the terminal.

The terminal is a data concentrator of the sub-network controlled by it, since it can control a maximum of 4 units through a single terminal.

Variable	Meaning	Address			
		Contr 0	Contr 1	Contr 2 / Exp 0	Contr 3 / Exp 1
Digital output	Not used	0	40	80	120
	Triac 2	1	41	81	121
	Triac 1	2	42	82	122
	Q5	3	43	83	123
	Q4	4	44	84	124
	Q3	5	45	85	125
	Q2	6	46	86	126
	Q1	7	47	87	127
	supply fan thermostat	8	48	88	128
	return fan thermostat	9	49	89	129
	electric heater thermostat	10	50	90	130
	Enable post-ventilation with electric heater thermostat on	11	51	91	131
	Not used	12..15	52..55	92..95	132..135
	Dirty filter	16	56	96	136
	generic antifreeze /fan in action	17	57	97	137
	Defrost electric heater 1	18	58	98	138
	Defrost electric heater 2	19	59	99	139
	Not used	20..23	60..63	100..103	140..143
	supply humidity sensor malfunction	24	64	104	144
	VOC air quality sensor malfunction	25	65	105	145
	CO2 air quality sensor malfunction	26	66	106	146
	room temperature sensor on URT malf.	27	67	107	147
	Not used	28..31	68..71	108..111	148..151
	pressure sensor malfunction	32	72	112	152
	water temperature sensor malf.	33	73	113	153
	outside temperature sensor malfunction	34	74	114	154
	antifreeze temperature sensor malfunction	35	75	115	155
	suply tmperature sensor malfunction	36	76	116	156

		Address			
	room temperature sensor malfunction	37	77	117	157
	exhaust air temperature sensor malfunct.	38	78	118	158
	return humidity sensor malfunction	39	79	119	159
Digital input	Status of digital input 4	0	16	32	48
	Status of digital input 3	1	17	33	49
	Status of digital input 2	2	18	34	50
	Status of digital input 1	3	19	35	51
	Digital input 4	4	20	36	52
	Digital input 3	5	21	37	53
	Digital input 2	6	22	38	54
	Digital input 1	7	23	39	55
	Not used	8..15	24..31	40..47	56..63
Analog output	Output Y1 (0..200) (divided by 20, V DC)	0	4	8	12
	Output Y2 (0..200) (divided by 20, V DC)	1	5	9	13
	Output Triac 1 (0..200) (divided by 2, %)	2	6	10	14
	Output Triac 2 (0..200) (divided by 2, %)	3	7	11	15
	Revision Software (divided by 100, use period as separator)	16			
	Day and time RTC (time conversion)	17			
Analog Input	Probe B2 – CH1	0	4	8	12
	Probe B1 – CH2	1	5	9	13
	Probe B3 – CH3	2	6	10	14
	Probe B4 – CH4	3	7	11	15
	Temperature of terminal probe (divided by 10, °C)	16			
	Not used	17			
	DEF_EEP_NOT_USED (0..255) (pure value)	18			
	DEF_EEP_NOT_USED_BIS (0..255) (pure value)	19			
	REGULATION_TYPE (0..10) (pure value)	20			
	REGULATION_SENSOR (0..2) (pure value)	21			
	SET_POINT (60..320)(divided by 10, °C)	22			
	WATER_SET_POINT(250..450)(divided by 10, °C)	23			
	ANTIFREEZE_SET_POINT(0..150)(divided by 10, °C)	24			
	HEAT_SET_POINT(150..450)(divided by 10, °C)	25			
	FAN_1_LIMIT (2..200) (divided by 2, %)	26			
	FAN_2_LIMIT (2..200) (divided by 2, %)	27			
	FAN_3_LIMIT (2..200) (divided by 2, %)	28			

	Address
PERC_PRESSURIZE (60..140) (no operation, %)	29
FREE_COOLING_DIFFERENTIAL(0..100) (divided by 10, °C)	30
HUMIDITY_SET_POINT (20..200) (divided by 2, % rH)	31
REGULATION_UMIDITY_SENSOR (0..1) (pure value)	32
HEAT_NEUTRAL_ZONE(5..50)(divided by 10, °C)	33
COOL_NEUTRAL_ZONE(5..50)(divided by 10, °C)	34
COOL_SET_POINT(50..350)(divided by 10, °C)	35
HUMIDITY_NEUTRAL_ZONE (0..60)(divided by 2, % rH)	36
HEATER_TYPE (0..3) (pure value)	37
HEATER_MODE (0..5) (pure value)	38
SUPPLY_FAN_SET_POINT_MIN_PRESS (0..200) (divided by 2, %)	39
SUPPLY_FAN_SET_POINT_MAX_PRESS (0..200) (divided by 2, %)	40
SUPPLY_FAN_SET_OFF_PRESS (20..200) (divided by 2, %)	41
WATER_CHANGE_OVER (0..1) (pure value)	42
SUMMER_COMPENSATION_BEGIN_POINT(100..350)(divided by 10, °C)	43
SUMMER_COMPENSATION_DELTA(0..100)(divided by 10, °C)	44
SUMMER_COMPENSATION_BAND(0..100)(divided by 10, °C)	45
WINTER_COMPENSATION_BEGIN_POINT(0..150)(divided by 10, °C)	46
WINTER_COMPENSATION_DELTA(0..100)(divided by 10, °C)	47
WINTER_COMPENSATION_BAND(0..100)(divided by 10, °C)	48
SUPPLY_HIGH_TEMPERATURE_LIMIT(150..600)(divided by 10, °C)	49
SUPPLY_LOW_TEMPERATURE_LIMIT(80..600)(divided by 10, °C)	50
SUPPLY_HIGH_TEMPERATURE_DIFFERENTIAL(10..300)(divided by 10, °C)	51
SUPPLY_LOW_TEMPERATURE_DIFFERENTIAL(10..300)(divided by 10, °C)	52
REGULATION_PRIORITY (0..1) (pure value)	53

	Address
HEAT_HIGH_TEMPERATURE_LIMITE(0..350)(divided by 10, °C)	54
HEAT_LOW_TEMPERATURE_LIMITE(0..350)(divided by 10, °C)	55
COOL_HIGH_TEMPERATURE_LIMITE(0..350)(divided by 10, °C)	56
COOL_LOW_TEMPERATURE_LIMITE(0..350)(divided by 10, °C)	57
CHANNEL_1_SENSOR_TYPE (0..11) (pure value)	58
CHANNEL_2_SENSOR_TYPE (0..11) (pure value)	59
CHANNEL_3_SENSOR_TYPE (0..11) (pure value)	60
CHANNEL_4_SENSOR_TYPE (0..11) (pure value)	61
CALIBRATION_AMBIENT_TEMP (0..100) ((valore-50)/10, °C)	62
CALIBRATION_EXTERN_TEMP (0..100) ((valore-50)/10, °C)	63
CALIBRATION_AIR_EXPULSION_TEMP (0..100) ((valore-50)/10, °C)	64
CALIBRATION_SENDING_PRESSURE (0..20) ((valore-10)/2, %)	65
COOL_HYSTERESYS (5..100) (divided by 10, °C)	66
HEAT_HYSTERESYS (5..100) (divided by 10, °C)	67
WATER_HEAT_HYSTERESYS (5..50) (divided by 10, °C)	68
MAX_WATER_SET_POINT(200..280)(divided by 10, °C)	69
SET_POINT_MANDATA(200..280)(divided by 10, °C)	70
POST_HYSTERESIS (200..280)(divided by 10, °C)	71
BANDA_POST(200..280)(divided by 10, °C)	72
DELTA_STEP_POST(200..280)(divided by 10, °C)	73
TIP (0..255) (pure value)	74
TIC (0..255) (pure value)	75
TIF (0..255) (pure value)	76
ANTIFREEZE_HYSTERESYS(5..100)(divided by 10, °C)	77
LOW_LIMIT_DEFROST_TIME (0..300) (seconds)	78

	Address
HIGH_LIMIT_DEFROST_TIME (0..300) (seconds)	79
IN_BETWEEN_DEFROST_TIME (0..300) (minutes)	80
HUMIDITY_HYSTERESIS_SET_POINT (0..60) (divided by 2, % rH)	81
CHANNEL_1_OUTPUT_TYPE (0..23) (pure value)	82
CHANNEL_2_OUTPUT_TYPE (0..23) (pure value)	83
CHANNEL_3_OUTPUT_TYPE (0..23) (pure value)	84
CHANNEL_4_OUTPUT_TYPE (0..23) (pure value)	85
CHANNEL_5_OUTPUT_TYPE (0..23) (pure value)	86
CHANNEL_6_OUTPUT_TYPE (0..23) (pure value)	87
CHANNEL_7_OUTPUT_TYPE (0..23) (pure value)	88
TRIAC_1_CONTROL_TYPE (0..8) (pure value)	89
TRIAC_2_CONTROL_TYPE (0..8) (pure value)	90
FAN_MODE (0..1) (pure value)	91
FAN_1_COOL_HYSTERESIS(0..50)(divid ed by 10, °C)	92
FAN_1_COOL_DELTA(0..50)(divided by 10, °C)	93
FAN_2_COOL_HYSTERESIS(0..50)(divid ed by 10, °C)	94
FAN_2_COOL_DELTA(0..50)(divided by 10, °C)	95
FAN_3_COOL_HYSTERESIS(0..50)(divid ed by 10, °C)	96
FAN_1_HEAT_HYSTERESIS(0..50)(divide d by 10, °C)	97
WATER_HYSTERESYS(5..50)(divided by 10, °C)	98
ANTISTRATIFICATION_SINGLE_PULSE (0..255) (seconds)	99
ANTISTRATIFICATION_PERIOD (0..255) (minutes)	100
PLANT_TYPE (0..6) (pure value)	101
COOL_VALVE_TYPE (0..2) (pure value)	102
HEAT_VALVE_TYPE (0..2) (pure value)	103
WARM_UP_TIME (30..240) (seconds)	104

		Address
	WARM_UP_PAUSE_TIME (1..60) (minutes)	105
	DEHUMIDITY_HYSTERESIS_SET_POIN T (0..60) (divided by 2, % rH)	106
	TOTAL_VALVE_TIME (0..255) (pure value)	107
	MINIMUM_VALVE_VARIATION_TO_MOV E (0..200) (divided by 2, %)	108
	MINIM_OPEN_HEAT_VALVE (0..200) (divided by 2, %)	109
	MINIM_OPEN_COOL_VALVE (0..200) (divided by 2, %)	110
	GESTIONE_ANTIGELO (0..3) (pure value)	111
	STOP_VALVE_TIME (1..255) (minutes)	112
	POSITION_VALVE_TIME (0..20) (minutes)	113
	TYPE_OF_POST_HEATING (0..5) (pure value)	114
	ON_TIME (1..10) (minutes)	115
	HEATER_HYSTERESIS(0..50)(divided by 10, °C)	116
	HEATER_PROPORNTINAL_BAND(0..50) (divided by 10, °C)	117
	CALIBRATION_URT_ROOM_TEMP (0..100) ((value-50)/10, °C)	118
	TIR (0..255) (pure value)	119
	DELTA_INT_VALUE(0..100)(divided by 10, °C)	120
	DELTA_MAIN_STEP (0..100)(divided by 10, °C)	121
	DIG_INPUT_1_LOGIC (0..1) (pure value)	122
	DIG_INPUT_2_LOGIC (0..1) (pure value)	123
Reading Data	DIG_INPUT_3_LOGIC (0..1) (pure value)	124
	DIG_INPUT_4_LOGIC (0..1) (pure value)	125
	DIG_INPUT_1_TYPE (0..13) (pure value)	126
	DIG_INPUT_2_TYPE (0..13) (pure value)	127
	DIG_INPUT_3_TYPE (0..13) (pure value)	128
	DIG_INPUT_4_TYPE (0..13) (pure value)	129
	FILTER_ALARM_TIME (0..250) (pure value)	130
	REGULATION_RANGE_TRIAC_1 (0..255) (pure value)	131
	REGULATION_RANGE_TRIAC_2 (0..255) (pure value)	132
	OPTION_1 (0..1) (pure value)	133
	KEYPAD_LOCK (0..16) (pure value)	134

	Address
DEGREE_TYPE (0..1) (pure value)	135
PROBE_TO_DISPLAY (0..255) (pure value)	136
PWM_OUTPUT_TYPE_CHANNEL_PWM2_not used (0..16) (pure value)	137
O_10V_OUTPUT_TYPE_CHANNEL_Y1 (0..4) (pure value)	138
O_10V_OUTPUT_TYPE_CHANNEL_Y2 (0..3) (pure value)	139
TRIAC_OUTPUT_TYPE_CHANNEL_TR1 (0..1) (pure value)	140
TRIAC_OUTPUT_TYPE_CHANNEL_TR2 (0..1) (pure value)	141
FAN_TYPE_REGULATION (0..2) (pure value)	142
SUPPLY_FAN_SET_POINT_MIN_AIR_QUALITY (0..200) (divided by 2, %)	143
SUPPLY_FAN_SET_POINT_MAX_AIR_QUALITY (0..200) (divided by 2, %)	144
SUPPLY_FAN_SET_OFF_AIR_QUALITY (0..200) (divided by 2, %)	145
LOW_LIMIT_OUTPUT (0..200) (divided by 2, %)	146
NOT_USED_1 (0..255) (pure value)	147
HIGH_LIMIT_OUTPUT (0..200) (divided by 2, %)	148
NOT_USED_2 (0..255) (pure value)	149
SYSTEM_STATUS_SETTING (0..255) (pure value)	150
DELTA_STEP_ANTIFREEZE (0..50)(divided by 10, °C)	151
FAN_1_HEAT_DELTA(0..50)(divided by 10, °C)	152
FAN_2_HEAT_HYSTERESIS(0..50)(divided by 10, °C)	153
FAN_2_HEAT_DELTA(0..50)(divided by 10, °C)	154
FAN_3_HEAT_HYSTERESIS(0..50)(divided by 10, °C)	155
REMOTE_ON_OFF_INPUT (0..1) (pure value)	156
REMOTE_HEAT_COOL_INPUT (0..1) (pure value)	157
TIMEOUT_FREECOOLING (0..255) (minutes)	158
PRESSURE_MEASURE_TIMEOUT (0..255) (seconds)	159

	Address
CHANNEL_5_SENSOR_TYPE (0..11) (pure value)	160
CHANNEL_6_SENSOR_TYPE (0..11) (pure value)	161
CHANNEL_7_SENSOR_TYPE (0..11) (pure value)	162
CHANNEL_8_SENSOR_TYPE (0..11) (pure value)	163
CALIBRATION_WATER_BATTERY_TEMP (0..100) ((valore-50)/10, °C)	164
CALIBRATION_NO_FROST_TEMP (0..100) ((valore-50)/10, °C)	165
CALIBRATION_AIR_SENDING_TEMP (0..100) ((valore-50)/10, °C)	166
CALIBRATION_RETURN_UMIDITY (0..20) ((valore-10)/2, %)	167
CALIBRATION_SENDING_UMIDITY (0..20) ((valore-10)/2, %)	168
CALIBRATION_AIR_QUALITY_VOC (0..20) ((valore-10)/2, %)	169
CALIBRATION_AIR_QUALITY_CO2 (0..20) ((valore-10)/2, %)	170
CHANNEL_8_OUTPUT_TYPE (0..20) (pure value)	171
CHANNEL_9_OUTPUT_TYPE (0..20) (pure value)	172
CHANNEL_10_OUTPUT_TYPE (0..20) (pure value)	173
CHANNEL_11_OUTPUT_TYPE (0..20) (pure value)	174
CHANNEL_12_OUTPUT_TYPE (0..20) (pure value)	175
DIG_INPUT_5_LOGIC (0..1) (pure value)	176
DIG_INPUT_6_LOGIC (0..1) (pure value)	177
DIG_INPUT_7_LOGIC (0..1) (pure value)	178
DIG_INPUT_8_LOGIC (0..1) (pure value)	179
DIG_INPUT_5_TYPE (0..13) (pure value)	180
DIG_INPUT_6_TYPE (0..13) (pure value)	181
DIG_INPUT_7_TYPE (0..13) (pure value)	182
DIG_INPUT_8_TYPE (0..13) (pure value)	183
O_10V_OUTPUT_TYPE_CHANNEL_Y3 (0..4) (pure value)	184
O_10V_OUTPUT_TYPE_CHANNEL_Y4 (0..3) (pure value)	185
TIME_FOR_STAR_STARTUP (0..200) (pure value)	186

	Address
DELAY_STAR_TRIANGLE (0..100) (pure value)	187
STAR_TRIANGLE_DELAY (0..1) (pure value)	188
DISABLE_AUTOMATIC_RESTART (0..1) (pure value)	189
PROGRESSIVE_EEPROM (0..255) (pure value)	190
ALARMS_31_24 (0..255) (pure value)	191
ALARMS_23_16 (0..255) (pure value)	192
ALARMS_15_8 (0..255) (pure value)	193
ALARMS_7_0 (0..255) (pure value)	194
TIMER_FILTER_DIRTY (0..255) (pure value)	195
DELAY_START_DEFROST (1..30) (minutes)	196
SETPOINT_START_DEFROST (0..100) ((value-200)/10, °C)	197
SETPOINT_END_DEFROST (0..100) ((value-200)/10, °C)	198
MAX_DEFROST_LIMIT (1..254) (minutes)	199
DELAY_DEFROST_FAN (1..254) (seconds)	200
SETPOINT_ANTIFREEZE_ON (0..50)(divided by 10, °C)	201
MINIMUM_INTERV_ON_COMPRESSOR E (1..15) (minutes)	202
MINIMUM_ON_TIME_COMPRESSOR (1..15) (minutes)	203
FIRST_DIFFERENTIAL (10..40)(divided by 10, °C)	204
SECOND_DIFFERENTIAL (10..40)(divided by 10, °C)	205
HEAT 2 DIAL (0..1) (pure value)	206
COOL_4_DIAL (0..1) (pure value)	207
REVERSE_DELAY (0..20) (seconds)	208
FIRST_BAND_START_TIME_P1 (0..2400) (time)	209
FIRST_BAND_STOP_TIME_P1 (0..2400) (time)	210
SET_POINT_FIRST_BAND_P1 (60..320)(divided by 10, °C)	211
SECOND_BAND_START_TIME_P1 (0..2400) (time)	212
SECOND_BAND_STOP_TIME_P1 (0..2400) (time)	213

	Address
SET_POINT_SECOND_BAND_P1 (60..320)(divided by 10, °C)	214
BAND_START_TIME_P2 (0..2400) (time)	215
BAND_STOP_TIME_P2 (0..2400) (time)	216
BAND_SET_POINT_P2 (60..320)(divided by 10, °C)	217
BAND_SET_POINT_P3 (60..320)(divided by 10, °C)	218
PROGRAM_SUNDAY (0..4) (pure value)	219
PROGRAM_MONDAY (0..4) (pure value)	220
PROGRAM_TUESDAY (0..4) (pure value)	221
PROGRAM_WEDNESDAY (0..4) (pure value)	222
PROGRAM_THURSDAY (0..4) (pure value)	223
PROGRAM_FRIDAY (0..4) (pure value)	224
PROGRAM_SATURDAY (0..4) (pure value)	225
DISPLAY_TIME (0..1) (pure value)	226
ENABLE RKE ANTIFREEZE	227
SET_RKE_ANTIFREEZE	228
RKE_ANTIFREEZE_SETTING	229
CONFIGURATION (0..31) (pure value)	230
EEP_VERSION (0..255) (pure value)	231
CHECKSUM (0..255) (pure value)	232

Notes for viewing data

All the data are in the format WORD WITHOUT SIGN, except the analogue inputs which are WORD WITH SIGN.

The first parentheses contain the range with which the data arrive, while the viewing range is drawn from the data present in the second parentheses.

The meanings of the data are indicated in red in the second parentheses, indicating, before the comma, the operations to perform on the data prior to display, and after the comma, the unit of measure to display. The explanations follow here below.

(pure value) → view the data as received, in decimal form where no other format is specified

(divided by 10, °C) → divide the value by 10, the result will be in centigrade degrees with one decimal (E.g.: 153 = 15.3°C)

(divided by 2, % rH) → divide the value by 2, the result will be the percentage of humidity with one decimal (E.g.: 131 = 65.5% rH)

(seconds) → displays the value received in seconds

(divided by 2, %) → divide the value by 2, the result will be a percentage value with accuracy 0.5% (E.g.: 121 = 60.5%)

(divided by 20, V DC) → divide the value by 20, the result will be a voltage with 2 decimals (E.g.: 425 = 4.25V DC)

((value-100)/10, %) → subtract 100 from the value and divide by 10, the result will be a positive or negative percentage with accuracy to 0.5% and range between -10% and +10% (E.g.: 57 = -4.3%)

((value-50)/10, °C) → subtract 50 from the value, divide by 10, the result will be a positive or negative temperature with accuracy to 0.1°C and range between -5°C and +5°C (E.g.: 23 = -2.7°C)

((value-10)/2, %) → subtract 10 from the value, divide by 2, the result will be a percentage with accuracy to 0.5% and range between -5% and +5% (E.g.: 7 = -1.5%)

((value-100)/200, V DC) → subtract 100 from the value, divide by 200, the result will be a positive or negative voltage with accuracy to 0.01V DC and range between -0.5V DC and +0.5V DC (E.g.: 23 = -0.27Vdc)

(view the upper and lower part) → separate display for the upper and lower part of the value at 16 bit, separated by a period, in hexadecimal (E.g. 0x0134 = 01.34)

(time conversion) → this item arrives in 16 bit in the following formula: 4bit for the day (0:sun, 1:mon, 2:tue, 3:wed, 4:thu, 5:fri, 6:sat), 6 bit for the time (0..23) and 6 bit for the minutes (0..59). the binary forma in the word is as follows: MSB:DDDDHHHH LSB:HHMMMMMM. Display the date as a word and the time separated by two periods. (E.g. 0x53E2 = 0b0101001111100010 = Friday at 15:34)

Example:

Delivery temperature (-50..+980)(divided by 10, °C) → the item arrives as SIGNED INT with range between -90 and +980, and will be displayed with a range that goes from -5.0 °C to +98.0 °C.

Error value signals

In case of **Analogue inputs 0, 1, 2 and 3**, for value received equal to **3000 display INPUT SHORT**, for value received equal to **-3000 display INPUT OPEN**. In all other cases of value out of the range display an error message.

6. Troubleshooting

Communication errors

Communication errors refer to malfunctions in communication between the terminal and the control.

They are shown on the display with the wording “**Er:**” followed by the error code, described hereafter.

- Er.24 no control found
- Er.25 no response after initial transmission of parameters
- Er.26 no response from control with valid alignment parameters
- Er.27 loss of control by the network
- Er.29 alignment error between controls and relative expansions, both in number and in address
- Er.3x loss of communication between terminal and control with address x

In the presence of these errors, check the hardware settings of the machine (DIP switches) and correct connection of the power wires of the terminal (CE+ and CE-) and reboot the machine.

In case of “Er:3x” in Output from the programming of one or more parameters, it may be necessary to reprogram them after rebooting the machine.

If during operation a control loses communication with the terminal, it automatically goes into stand-by status, and resume correct function if communication returns. The same occurs if the terminal loses a control, the signal “Er:3x” may stop at any time in case communication is resumed.

NOTE: After programming, before switching off the machine wait 20s to ensure that the settings are correctly saved in the permanent internal memory of the control.

Alarm signal

Alarm signals derive from errors on the probes installed (if set) and on the machine settings.

They can be viewed on the display using the wording “**E**” followed by the number of the control that detected the error and the error code, as described below.

“**Ex:yy**” with **x** that varies from 0 to 7, indicating that the error with code **yy** was detected on the control with address **x** (selected using switches 1, 2 and 3 of the dip switches on the control).

Error codes (**yy**):

- 01: delivery pressure probe malfunction
- 02: battery water temperature probe malfunction
- 03: outside temperature probe malfunction
- 04: antifreeze temperature probe for battery malfunction
- 05: delivery air temperature probe malfunction
- 06: room/return temperature probe malfunction
- 07: expulsion air temperature probe malfunction
- 10: VOC air quality probe malfunction
- 11: CO₂ air quality probe malfunction
- 12: room temperature probe on terminal malfunction

Example: the signal “**E3:05**” means that the control with address 3 has detected an error on the outside temperature probe (code **05**).

When a probe error occurs, the machine is placed temporarily on Stand-By. When correct operation of the probe is restored, the machine starts again from the status previous to appearance of the error.

NOTE: In case of these errors, check that the probes configured (either manually or by default) are present, correctly connected and working properly. The error disappears on connection or replacement of the probe (also when the machine is on and running) or on reprogramming the parameter relative to Output (change of probe type or resetting the parameter, to indicate the absence of the probe).